



GOVERNANCE IN AUROVILLE

A FRAMEWORK STUDY
2023

RAAG YADAVA

NIDHI HARIHAR



GOVERNANCE IN AUROVILLE

A FRAMEWORK STUDY

2023

RAAG YADAVA
NIDHI HARIHAR

This work may be cited as:

Yadava, Raag, Harihar, Nidhi (2023). Governance in Auroville: A Framework Study, 2023.

Lead author: Raag Yadava

Second author: Nidhi Harihar

Research Associates: Nidhi Harihar, Andleeb Shadab and Rajesh Subburaj

Interns: Aman Garg and Anmol Kohli

Front cover image: the symbol on the cover is a synthesis of Sri Aurobindo and Mother's symbols. It depicts the effective manifestation of *Ishwara* and *Ishwari* in union, the ideal of Auroville. Source: The Mother. On Education. Volume 12. Collected Works of the Mother. Second Edition. Pondicherry: Sri Aurobindo Ashram Trust, 2002, 111.

Back cover image: an undated photo of the Mother in Pondicherry with disciples. Source: Overman Foundation, 2017.

Disclaimer: this study was independently funded. All views expressed are our own and do not reflect those of the Auroville Foundation, the National Law School of India University or any other entity.

The authors reserve moral rights to this work. The text of this publication may be freely quoted with proper acknowledgement.



Spirit of Auroville

CONTENTS

PART I: THE VISION AND CHALLENGE	3
A. FOUNDATIONAL PRINCIPLES	4
B. THE PREDOMINANCE OF A WORLD-AFFIRMING SPIRITUAL AIM	7
i. Involution and Evolution of the Divine Sachchidānanda	7
ii. The Psychic Entity as an Evolutionary Vehicle	9
iii. Ascent, Descent and the Synthesis	12
iv. Advance on Previous Traditions	17
v. Caution on Prematurity	19
vi. Caution on Rejection	22
vii. Auroville in Perspective	25
C. A COMMITMENT TO COLLECTIVE YOGA AND PROGRESSIVE FRATERNITY	27
i. The Scheme of Political Vedantism	27
ii. Perfection of Democratic Systems in Philosophic or Spiritual Anarchism	29
iii. The Play and Place of Reason	32
iv. The Dangerous Move from the Objective to Subjective	35
v. Hidden Telos of the Political Līlā	42
vi. Mistaking Vital for Philosophic or Spiritual Anarchism	45
vii. A Progressive Substitution of Rules with Inner Discipline	50
D. ARRANGEMENT OF PRODUCTIVE LIFE	59
i. Work as Aspiration and Offering	59
ii. Mutuality and Qualified Egalitarianism	62
iii. Reclaiming Production and a Culture of Abundance	64
iv. Renunciation as Ownership	68
v. Service-Based Governance, Illumined Hierarchies and Qualified Democracy	71
E. A COMMITMENT TO RESEARCH, INNOVATION AND FREE PROGRESS EDUCATION	78
PART II: THE VISION OF THE CITY	84
A. THE QUARTET-CITY SKETCH AND CITY CONCEPT	85
i. The Constituent Zones	85
ii. Matrimandir and the Park of Unity	89
iii. A Symbol for the Future	91
B. THE GALAXY PLAN	94
i. Early Planning and the Galaxy	94
ii. Features of the Galaxy	100
C. ‘THE CITY THE EARTH NEEDS’: AUROVILLE’S SPIRITUAL URBANISM	118
i. The Urban Question	118
ii. A Sketch of Auroville’s Urbanist Aspirations: Harmony in Density	119
iii. What the Earth Needs: Auroville’s Urban Future	140

D. ‘THE ELEPHANTS IN THE ROOM’: FALSE DICHOTOMIES	147
i. The First Elephant: A New City or a New Man	147
ii. The Second Elephant: Planned or Organic Development	153
E. SECTOR-WISE MAPPING OF AUROVILLE’S GROWTH: TANGIBLES AND INTANGIBLES	164
PART III: SECTORAL OVERVIEW	165
A. URBAN PLANNING AND INFRASTRUCTURE DEVELOPMENT	166
i. Movement in the Early Years, 1968-1999	166
ii. Four Orientations to Planning	172
iii. Review of the Perspective Masterplan, 1999-2001	174
iv. Phased Population Growth and Demographics	197
v. Review of Planning Strategies	204
vi. Planning Movements, 2001-2010	210
vii. Attempts to Draft a Detailed Development Plan, 2010-2015	230
viii. Vision Realignment, 2015-2019	254
ix. Crown Development, Mobility and Transport Networks, 2021-2023	273
x. Contemporary Governance Concerns	293
xi. Governance and Development Priorities	295
B. LAND ACQUISITION	311
i. Overview	311
ii. Challenges and Development Priorities	315
C. REGIONAL AND OUTREACH PLANNING	319
i. Regional Planning in the 1999 Masterplan	319
ii. Proposal for a New Town Development Authority	320
iii. Regional Planning Framework	349
iv. Regional Planning Priorities	356
v. Review of Bioregional Outreach	358
vi. Challenges and Development Priorities	372
D. HOUSING	377
i. Early Vision, 1965-1980s	377
ii. Semi-Planned Approach to Housing Development, 1980s-2008	385
iii. Housing Strategy Prioritizing Economic Self-Sufficiency, 2009- 2019	390
iv. Feduchi’s 2014 Draft Development Plan for Residential Zone Sectors 1 and 2	396
v. Town Development Council, Annual Development Plan, 2014-15	404
vi. 2015 Retreat and 2019 TDC Development Priorities	406
vii. Challenges and Development Priorities	409
E. EDUCATION AND RESEARCH	419
i. The Early Years	419
ii. Consolidation post 1984 for Systematic Expansion	422
iii. The Pande Visiting Committee	426
iv. Snapshot of the Sector Today	435

v.	Challenges and Development Priorities	441
F.	ECONOMY AND COMMERCE	487
i.	Guiding Principles	487
ii.	A Historical Sketch: Four Phases of Growth	491
iii.	Challenges and Development Priorities	507
G.	AGRICULTURE	588
i.	Early Efforts	588
ii.	Food Security	590
iii.	Green Belt Planning Framework	594
iv.	Current Status	598
v.	Development Priorities	599
	PART IV: GOVERNANCE REFORM	604
A.	MAPPING GOVERNANCE FORMS	605
i.	Mapping the Evolution of Governance Forms	605
ii.	Movement Upwards from the Physical to Spiritual: the ‘Y’ Axis	609
iii.	Collectivism, Individualism and Resistant Centralization: the ‘X’ Axis	620
iv.	Movement from the Outer to Inner: the ‘Z’ Axis	631
v.	A Speculative Mapping of Governance to Mother’s Powers	662
vi.	Institutional Limits	664
vii.	Questions to Consider	667
B.	RESTRUCTURING THE RESIDENTS’ ASSEMBLY	671
i.	Rationale and Limits of Assemblies	671
ii.	Direct Democracy At Scale	679
iii.	Participation, Representation and Federation	683
iv.	Aggregating Interest, Consensus and Veto	700
v.	Bicameralism	708
vi.	Procedural Forms for Informed Deliberation	709
vii.	Legislative and Executive Domains	711
C.	WORKING GROUPS REFORM	714
i.	Working Group Mandates, Powers and Inter-Sectoral Linkages	715
ii.	Selection Processes	722
iii.	Accountability	725
iv.	Enforcement and Dispute Resolution	726
v.	Community Participation and Co-Production	729
D.	INSTITUTIONAL TEMPLATE	734
i.	Organizational Design Principles	734
ii.	Suggested Templates	738
E.	PUBLIC CULTURE	742
i.	Assimilation, Entry and Population Growth	742
ii.	Exit Mechanisms	749

iii. Rule Enforcement and Spiritual Compulsion	753
iv. Stewarding Public Culture	758
v. Place of Mother and Sri Aurobindo's Thought	765
PART V AUROVILLE FOUNDATION ACT, 1988: INTERPRETIVE SCHEME	782
A. HISTORY AND ORIGINS: CONFLICT WITH THE SRI AUROBINDO SOCIETY	783
i. The Passage of the 1980 Act	783
ii. Constitutionality of the 1980 Act: SP Mittal v. Union of India	785
B. DRAFTING HISTORY OF THE 1980 ACT	787
i. A 'Temporary Takeover'	787
ii. Continuation of the 'Temporary Takeover'	791
C. STRUCTURE AND SCHEME OF DISTRIBUTED POWERS UNDER THE AVF ACT	794
i. Structure of the AVF Act	794
ii. Relative Distribution of Powers	796
D. PURPOSIVE INTERPRETATION: TENSION BETWEEN SPIRITUAL SUBSTANCE AND LEGAL FORM	799
i. Authorial Intention	800
ii. Mother's Guidance	801
iii. Comparison with Analogous Legislations	804
iv. Mapping the AVF Act to Sri Aurobindo's Ideal of Human Unity	806
v. Mr. Sorabjee's Opinion	812
vi. Concluding Remarks: Mutual Interdependence of Governing Board and Residents' Assembly	815
vii. Role of the International Advisory Council	817
viii. Post Enactment Administrative Conventions	818
E. PAST ADMINISTRATIVE PRACTICE AND SUGGESTIONS	821
i. Dual Constitution and Nomination	821
ii. Clarification on Section 20(4)	822
iii. Mutuality and Dual Accountability	824
F. THE LIMITS OF LAW	827
CONCLUDING NOTES	829
BIBLIOGRAPHY	835

INTRODUCTION

This is a framework study to map and examine the evolution of governance and organizational practices in Auroville, spanning seven key sectors, as against Mother's guidance on Auroville read in the background of the conceptual architecture of Sri Aurobindo's *Human Cycle* and *Ideal of Human Unity*. The sectors considered were education and research, economy and commerce, city planning and urban infrastructure development, land acquisition, housing, agriculture and outreach. **Part I** outlines Mother's spiritual and socio-political vision for Auroville, in the background of Sri Aurobindo's thought. **Part II** charts her account of spiritual urbanism. **Part III** maps Auroville's empirical growth and provides a synoptic sector-wise overview across the seven sectors to identify governance challenges and development priorities. **Part IV** analyses this empirical picture as against the vision, to suggest governance reforms across the Residents' Assembly and Working Groups. **Part V** then examines governance structures encoded in the Auroville Foundation Act, 1988. **Part V** reviews the study to outline major findings and recommendations and offers concluding remarks on the need for urgent and bold action in a spirit of fraternity.

The study was conducted on an invitation from Dr. Jayanti Ravi, Secretary to the Auroville Foundation, in a short period from 11th April to 15th June 2023. I was asked to present 'an overview of the Auroville vision, the current situation and immediate suggestive measures.' This study therefore outlines, synoptically, themes in the evolution of Auroville's governance structures to draw out salient features for focussed consideration and action, with suggestions and recommendations where appropriate. We identify these themes chronologically, across the phases of Auroville's development, and institutionally, across the external (Governing Board, International Advisory Council and Secretary to the Foundation) and internal (Residents Assembly, Working Committee and Working Groups) governance instrumentalities. As in any study of this kind, we apply a critical lens to Auroville not to render easy criticisms from a distance but to better understand the complexities of manifesting Mother's ambitious vision and contribute to the growing literature on the subject.

Given the time constraints, we relied on previous compilations of primary developmental data, ethnographic material and secondary sources made available to us by the Auroville Foundation, Auroville Archives, various Working Groups and individual members of the community with an active involvement across sectors. We were also generously provided access to the Auroville Research Repository and output generated by study groups, both internal and external. We supplemented this with a series of semi-structured interviews and discussions with current (and in some cases, past) members of twenty-three Working Groups and seventy-five residents. Through this, we hope to have captured a sufficiently representative sense of the sectors to inform our analysis.

As a framework study, our aim is to outline and suggest pathways forward. Given our constraints, achieving a comprehensive coverage with detailed proposals was not possible. This leaves open the possibility of inaccuracy or gaps in our understanding. Equally, as time did not permit original fieldwork or robust cross-verification of views presented to us in the course of our discussions, some assessments may be anecdotal and our suggestions speculative, subject

to further study. We have benefited from previous studies conducted across sectors and incorporated their findings and reiterated their suggestions where appropriate. We have also pointed to areas for future research. Finally, we have been liberal in our quotations of Mother and Sri Aurobindo, along with other studies conducted over the years, to avoid selectivity and to inform our analysis in a close reading of these texts. Finally, given weak archival practices, we have included all sources shared with us in an extended bibliography to assist future research.

I am grateful to Dr. Ravi for the invitation to conduct this study, and to other members of the community, particularly Srijita Roy, Chandresh Patel, Sanjeev Ranganathan, Kristen Gravelle, Thambidurai, Varun Shiv Kapur and the team at Savitri Bhavan, for their hospitality and support during our stay. I am also grateful to the many Auroville residents who interacted with us for their warmth and generosity, as also for their candid reflections.

Our team comprised Nidhi Harihar, Andleeb Shadab and Rajesh Subburaj, research associates on the study, who cheerfully worked around the clock to meet demanding deadlines in the Aurovilian spirit of collaboration. Nishtha Vadehra provided timely and encouraging editorial support at short notice. Aman Garg and Anmol Kohli, our interns, assisted with quick and meticulous summaries.

Raag Yadava
Lead Author
Assistant Professor of Law
National Law School of India University

PART I
THE VISION AND CHALLENGE

*Amidst earth's mist and fog and mud and stone
It still remembers its exalted sphere
And the high city of its splendid birth.*

Sri Aurobindo, *Savitri*

Established in 1968, Auroville is an international cultural township devoted to the ideal of human unity, as a living manifestation of the spiritual vision of Mira Alfassa – the Mother, and Sri Aurobindo. It would take several volumes to do justice to Mother's vision for Auroville. Our attempt here is more modest: to provide a sketch of her vision and to reflect on central themes insofar as governance is concerned.

Section A introduces Mother's vision for Auroville in its spiritual and socio-political aspects, with reference to the *Charter* (1968), *Dream* (1954) and *To be a True Aurovilian* (1970), in the background of Sri Aurobindo's thought. Sections B to F detail this vision – **Section B** outlines the world-affirming spiritual aim as a constituent pillar of Auroville's founding ideal. **Section C** discusses the commitment to collective yoga and progressive fraternity. **Section D** addresses the place of rule-based enforcement, outlining Mother's view for a progressive substitution of external authority with an inner discipline, backed by spiritual compulsion in the public sphere. **Section E** considers Mother's arrangement of productive life in Auroville. **Section F** places research, innovation and free progress education as part of Auroville's founding commitment.

A. FOUNDATIONAL PRINCIPLES

Auroville's ideal is reflected in three foundational documents written by the Mother: the *Charter*, *A Dream* and *To Be a True Aurovilian*.¹ The vision that emanates from these documents is for Auroville to ground a *concentrated* and *collective* evolution, as both a *spiritual* and *material* forerunner for humanity. The Charter – akin to the spiritual constitution of Auroville – is a unique document that guides the collective; it is at once aspirational and directory. 'A Dream' expounds this vision, setting it in sharp relief to prevalent modes of collective organization. 'To be a True Aurovilian' sets the moral and spiritual compass – a call to arms, as it were – for each Auroville resident to make the dream a reality. In this section, we look to these documents and other words of the Mother, spoken or written during 1965-1973,² in the interpretive background of Sri Aurobindo's thought, to understand the spiritual and material ideal of Auroville.

The Charter proclaims:

Auroville belongs to nobody in particular. Auroville belongs to humanity as a whole. But, to live in Auroville, one must be a willing servitor of the Divine Consciousness.

Auroville will be the place of an unending education, of constant progress, and a youth that never ages.

Auroville wants to be the bridge between the past and the future.

Taking advantage of all discoveries from without and from within, Auroville will boldly spring towards future realisations.

Auroville will be a site of material and spiritual researches for a living embodiment of an actual human unity.

A detailed study of the Charter is beyond our scope here, but a brief statement of its core values is pertinent. The Charter embodies three core values.

First, the Charter calls for a transcendence of egoistic ownership, both individual and collective, towards a progressive offering to, and identification with, the Divine. This can be understood in relation to tangible (lands, assets, profits etc.) and intangible goods (power, control over collective decisions etc.). The Charter was written in 1968, in the ferment of an aggressive and resurgent nationalism, and the swelling tide of economic materialism driving a clash of competitive market-oriented egoisms. Read in that context, Auroville is dedicated to a *rooted cosmopolitanism* – where the 'group soul' of each culture and nationality retains and expresses its unique identity, and yet mingles freely in harmonious concert with others – and a *progressive ascension* beyond the triply-constituted ego complex of the body, life and mind towards the hidden psychic being, or soul, leading in the final culmination to the descent of the Supramental. As we discuss below, these central organizing ideals, expressed often at a level

¹ Mother, 1954, 1968, 1970.

² We have consulted the following three sources for Mother's guidance on Auroville: Guigan, 2018, Vols. 1-2; Mother on Auroville, 2015 and the records available at the Auroville Archives. Guigan's intrepid chronological compilation, with cross-references, was a particularly helpful resource – we are grateful to him for providing a digital copy of his work.

of abstraction, require further elucidation and specification to operationalize their commitments.

Second, the Charter embodies a call to constant progress, learning and improvement, as an antidote to the natural gravitational pulls of our lower egoistic nature, *apara prakriti*, that feeds on physical inertia and indolence, vital passions and desires and intellectual rigidity and partiality. The call to an unending education is a call at its highest – as Sri Aurobindo says in *Savitri* – to the ‘great adventure of consciousness and joy,’ that would turn Auroville into a ‘playground of the living Infinite.’³ This is not an easy rejection, or bypassing, of the body, life or mind, but a call to progressively purify, perfect and transform these instruments ‘as the fruit of a long and arduous self-training, self-deepening, self-heightening, self-expansion.’⁴ As Sri Aurobindo says in *Savitri*:

His soul lived as eternity’s delegate,
His mind was like a fire assailing heaven,
His will a hunter in the trails of light.⁵

Third, the Charter envisions a society that can integrate the considerable gains of the past, in material and spiritual domains, and ‘spring boldly towards future realizations.’ Mother’s call is to a challenging, yet joyous, life-affirming spiritual practice through work, *karma* yoga, that takes on all activities of life (reflected in her arrangement of the four zones, which we discuss below). It is one that assimilates that which is of value in the past through careful study and travels beyond towards discoveries yet unfound, ‘[p]ursuing all knowledge like a questing hound.’⁶ There is no unreasoned rejection of the past, including in its material or technological advances or hoary spiritual traditions, nor a hasty escape from the ills of life elsewhere, but a conscious movement towards a New Creation. Each activity becomes a ground for collaborative research, and an opportunity to express the highest perfection. Auroville, in the simplest of terms, is a collective being, a group-soul, aspiring to integrally consecrated itself to the Divine. As Sri Aurobindo notes:

The community of those who want the deva-jivana [a spiritual life] is the deva-sangha [a spiritual community] ... If the shadow of the fragile ego falls upon this sort of endeavour, the community turns into a sect ... You will perhaps ask, ‘What is the need of a sangha? Let me be free ... Let all become one, let all take place within that vast unity.’ All this is true, but it is only one side of the truth. Our business is not with the formless Spirit only; we have to direct life as well. Without shape and form, life has no effective movement.⁷

It is in the rendering of the collective aspiration in ‘shape and form’ – a careful, and in its advanced stages, spontaneous ordering of individual ego-selves aspiring to a collective harmony – that questions of governance and organization in Auroville are to be examined. The Charter sets out the foundational values of this organisation, but it is not a detailed or

³ Sri Aurobindo, CWSA, 1997, Vols. 33-34, 2, 22.

⁴ Sri Aurobindo, CWSA, 1997, Vols. 21-22, 608.

⁵ Sri Aurobindo, CWSA, 1997, Vols. 33-34, 23.

⁶ Sri Aurobindo, CWSA, 1997, Vols. 33-34, 39.

⁷ Sri Aurobindo, CWSA, 1997, Vol. 4, 362.

prescriptive document. Mother's *Dream* and *To Be a True Aurovilian* provide further insight into its core values. Read along with Sri Aurobindo's works, they reflect four foundational principles that speak to models of collective organization. We offer a brief philosophical perspective to Auroville's founding, and flag issues of particular contemporary relevance to Auroville's setup. These principles continue to inform our empirical analysis in Parts II-V. They are:

1. The predominance of a world-affirming spiritual aim.
2. A commitment to collective yoga and progressive fraternity, with
 - a. the perfection of democratic systems aspiring to a philosophical or spiritual anarchism,
 - b. a progressive substitution of external authority with an inner discipline.
 - c. backed by spiritual compulsion in the public sphere,
 - d. based on a non-exclusive engagement with Sri Aurobindo's Integral Yoga.
3. An arrangement of productive life
 - a. that is expressive, rather than transactional or hierarchical, in the spirit of *karma* yoga
 - b. that supports egalitarian access to basic public goods required for flourishing on a mutuality of need and capacity
 - c. that generates a culture of material abundance, but not excess, based on innovation-led production
 - d. that replaces individual or communal property ownership, with stewardship in service of the Divine
 - e. with the caveat that hierarchies of competence (spiritual or technocratic) rather than status, monetary or otherwise, are valuable.
4. A commitment to research, innovation and free progress education.

*

B. THE PREDOMINANCE OF A WORLD-AFFIRMING SPIRITUAL AIM

Auroville's spiritual constitution is premised on a double movement: the first is from an ascetic to life-affirming spirituality and the second is from individual to collective spirituality. It is this integrality, crossing barriers of the mundane and elevated, the inner and the outer, that renders Mother and Sri Aurobindo's thought distinctive.

Mother notes:

There should be somewhere on earth a place which no nation could claim as its own, where all human beings of goodwill who have a sincere aspiration could live freely as citizens of the world and obey one single authority, that of the supreme truth ...⁸

The first necessity is the inner discovery in order to know what one truly is behind social, moral, cultural, racial and hereditary appearances. At the centre there is a being free, vast and knowing, who awaits our discovery and who ought to become the active centre of our being and our life in Auroville.⁹

Auroville has been created for a progressive superhumanity, not for an infra-humanity governed by its instincts and dominated by its desires. Those who belong to the infra-humanity, ... have no place here. Auroville is for those who aspire for the supramental and make an effort to reach there.¹⁰

The Mother places a high ideal for Auroville, indeed the ultimate one. As a collective, it is to encourage and foster exclusive obedience to the spiritual truth. For individuals, the first necessity (not the final requirement) is the inner discovery of 'what one truly is' beyond appearance, the psychic being – all action is to be motivated from that realization. This call for a progressive move from an 'infra-humanity' to a 'super-humanity' covers a vast field, and requires a closer reading of Sri Aurobindo's works to map its defining features. Considered in perspective, Auroville's founding is to be understood not only, or indeed, primarily, as a response to the precipitating crises of the 60s and 70s, but in this long evolutionary landscape. This requires an examination of the broad scheme of Sri Aurobindo and Mother's thought. A detailed discussion is beyond our scope – in what follows, we provide a brief reconstruction of this double movement to place Auroville in perspective.

i. Involution and Evolution of the Divine Sachchidānanda

In his *Life Divine*, Sri Aurobindo presents a global argument, a complete portrait of being that examines the origins and culmination of humanity's emergence and evolution.¹¹ Arguing from the Vedantic tradition, Sri Aurobindo's metaphysics rests on a picture of progressive spiritual evolution from inert material states, or what he calls the 'inconscious,' to supra-conscious states, or the 'superconscient' Divine *sachchidānanda*. This evolution proceeds through intervening forms: *first* of Life – which emerged in increasingly complex forms of plant and animal life; *then* of Mind – which similarly emerged in increasingly complex forms, ending with 'the form

⁸ Guigan, 2018, Vol. 1, 50-1.

⁹ Guigan, 2018, Vol. 2, 145.

¹⁰ Guigan, 2018, Vol. 2, 425.

¹¹ See, for introductory essays to his collected works, Chikermane and Ganguli (eds.), 2022.

of thinking and mentally conscious life' in man; and *finally*, an as yet unrealized evolutionary future, the Supermind, his term for the Vedic *vijnanam*, a supra-rational intermediating principle which stands between the unmanifest Divine, the triune *sachchidānanda*, and the triple terms of the lower manifest existence, Matter, Life and Mind.¹²

For Sri Aurobindo, the evolution, 'of human consciousness, intelligence and mastery out of an unintelligent, blindly driving unconsciousness in which no form or substance of them previously existed' is possible only if such faculties were already *involved* in the unconscious forms that preceded it.¹³ In Sri Aurobindo's argument, since something cannot emerge out of nothing, *ex nihilo nihil fit*:

... there seems to be no reason why Life should evolve out of material elements or Mind out of living form, unless we accept the Vedantic solution that Life is already involved in Matter and Mind in Life because in essence Matter is a form of veiled Life, Life a form of veiled Consciousness. And then there seems to be little objection to a farther step in the series and the admission that mental consciousness may itself be only a form and a veil of higher states which are beyond Mind. In that case, the unconquerable impulse of man towards God, Light, Bliss, Freedom, Immortality presents itself in its right place in the chain as simply the imperative impulse by which Nature is seeking to evolve beyond Mind, and appears to be as natural, true and just as the impulse towards Life which she has planted in certain forms of Matter or the impulse towards Mind which she has planted in certain forms of Life.¹⁴

Sri Aurobindo thus extends the involutory logic of our prior evolution – the emergence of life from matter, and mind from life – forward to argue that there are no *a priori* reasons to 'pause at a given stage of ... evolution'.¹⁵ Analogizing the future with the past, he argues that *just as* the 'more sensitive reactions of Life in the metal and the plant' present to us in an 'ascending series' of emerging conscious reflexivity 'in which Nature has ... worked out man' from the 'living laboratory' of the animal, *similarly* man 'himself may well be a thinking and living laboratory in whom and with whose conscious co-operation' Nature wills out further ascensions of Spirit.¹⁶ Sri Aurobindo thus argues in defence of higher states of consciousness common to all spiritual enterprise and yet uncommon to ordinary life as the natural evolutionary emergence of the unmanifest, latent potencies of being. States of supra-rational consciousness, culminating in the Divine Absolute, that exceed the thinking and feeling intellectual being, which thus seem 'extraordinary and miraculous' at face value may be admitted,¹⁷ or at least, present reasons to consider plausible, as gradations of a progressive 'self-revealing' of the hidden Spirit, which has involved, or more playfully, cloaked, itself in

¹² Sri Aurobindo, CWSA, 1997, Vols. 21-22, Chs. 1-3. There is an emerging body of literature on a comparative reading of Sri Aurobindo's evolutionary scheme, with other traditions, both spiritual, Indic and otherwise, and naturalistic. *See*, for example, Medhananda, 2022a; *see also*, a range of older works by Amal Kiran, Nolini Kanta Gupta, Kishore Gandhi, Haridas Chaudhuri, Bruteau Beatrice, Kireet Joshi, Stephen Phillips and others. We offer only a summary outline here, but this is an exciting area for research in Auroville.

¹³ Sri Aurobindo, CWSA, 1997, Vols. 21-22, 97.

¹⁴ Sri Aurobindo, CWSA, 1997, Vols. 21-22, 5.

¹⁵ Sri Aurobindo, CWSA, 1997, Vols. 21-22, 6.

¹⁶ Sri Aurobindo, CWSA, 1997, Vols. 21-22, 5-6.

¹⁷ Sri Aurobindo, CWSA, 1997, Vols. 21-22, 803.

its precise opposite, inconscient or inert Matter, that seem to demonstrate no conscious properties.¹⁸

So understood, the logic of evolution in Sri Aurobindo's scheme, or what he calls the 'logic of the infinite', is – inspired by the Vedantic *līlā* – the sportive playful self-involution (or more solemnly, 'a deep and perilous plunge') of the triune Existence-Consciousness-Bliss, or Divine *sachchidānanda*, into the apparent self-oblivion, suffering and evil of material Inconscience for the sheer creative joy of self-discovery of its all-blissful Unity in this world of suffering and separative forms, or Multiplicity.¹⁹ The self-revealing of the Divine, *puruṣa* in Nature, *prakṛti* is, for Sri Aurobindo, the keynote of our spiritual evolution:

If it be true that Spirit is involved in Matter and apparent Nature is secret God, then the manifestation of the divine in himself and the realisation of God within and without are the highest and most legitimate aim possible to man upon earth.²⁰

ii. *The Psychic Entity as an Evolutionary Vehicle*

Importantly, this ontological scheme carries the individual soul, or *jīva*, at the centre of the cosmic self-unfolding: the individual, comprising mind, life and body, or his individual *prakṛti*, has a 'fourth principle which comes into manifestation ... at the 'nodus' of mind, life and body, that which we call the soul,' or his individual *puruṣa*.²¹ This fourth principle is a 'projection and an action of the ... divine principle' of *sachchidānanda* in the material manifestation, but 'an action ... under the conditions of soul-evolution in this world.'²² As the evolutionary vehicle, this psychic being, our true individuality, retains continuity through successive embodiments – Sri Aurobindo's thought is thus premised on the doctrine of rebirth: the *puruṣa* transmigrates through successive embodiments, thus maintaining a link between our lives.²³ The purpose of our existence then is to 'kindle' the Divine spark of the *puruṣa* which wears a 'dull mask' or 'sleep ... of a drugged and imprisoned consciousness,' through the experiences of the dualities of good and evil, pleasure and pain, which accompany this process of soul-evolution in a seemingly undivine world until we recover our underlying identity with the Divine.²⁴ This movement from the false but necessary identification with the ego-self to the psychic being is the keynote of the first inner movement in the long symphonic dance of Sri Aurobindo and Mother's yoga, what Mother called the 'first necessity'.

This psychic entity 'is an eternal portion' of the Divine embodied in the individual, our own 'deepest being', of which we remain unaware owing to our identification with the 'superficial self', or our material nature, which Sri Aurobindo terms the embodied 'desire-soul.'²⁵ Crucially, in Sri Aurobindo's scheme, the *chaitya puruṣa* element of the soul (or evolutionary

¹⁸ See, for a discussion, Medhananda, 2022c.

¹⁹ The *avidya* of the Vedantic tradition, defined as ego-driven ignorance of the seemingly undivine relative and multiple consciousness. Sri Aurobindo, CWSA, 1997, Vols. 33-34, 592, 76.

²⁰ Sri Aurobindo, CWSA, 1997, Vols. 21-22, 6.

²¹ Sri Aurobindo, CWSA, 1997, Vols. 21-22, 277-8, 239-44.

²² Sri Aurobindo, CWSA, 1997, Vols. 21-22, 277-78.

²³ Sri Aurobindo, CWSA, 1997, Vols. 21-22, 771-855.

²⁴ Sri Aurobindo, CWSA, 1997, Vols. 21-22, 50.

²⁵ Sri Aurobindo, CWSA, 1997, Vols. 21-22, 339, 234-41.

psychic being, *see*, diagram below) transmigrates through successive embodiments, growing through its experiences, ‘benign’ ones and ‘our most poignant sufferings, difficulties and misfortunes’, until it awakens and blossoms into full fruition, a ‘psychic being’ or completed soul-personality, that has recovered its hidden unity with the Divine.²⁶ Accordingly, the purpose of the psychic entity’s descent into the material manifestation, co-terminus with the Divine’s free and unchecked creative impulse, is to consensually participate in the evolutionary transformation of the world from its inconscient to superconscient states, along the ‘shining ladder of ascending degrees and successive constituent formations of the gnostic light and power in earth-nature.’²⁷ Challenges – in the Auroville context, of city-building amongst others – are thus the creative ground for this realization, towards the *first* necessity (and in itself a major step) to be a true Aurovilian: the discovery the psychic being. Pain and disharmony attendant to grand exercises like building Auroville, in Sri Aurobindo’s theodicy, serve their purpose by fortifying growth, as instruments for an integral realization. Challenges avoided, owing to the possibility of pain, discomfort or failure, are opportunities for growth missed.

Rather, a consensual undertaking to enter the field of play, *defined* by its dangers and difficulties, inspires this verse from *Savitri* and serves as a reminder of the spirit of bold experimentation that must animate city-building as we discuss in Parts II and III:

It was drawn to hazard’s call and danger’s charm,
It yearned to the pathos of grief, the drama of pain,
Perdition’s peril, the wounded bare escape,
The music of ruin and its glamour and crash,
The savour of pity and the gamble of love
And passion and the ambiguous face of Fate.
A world of hard endeavour and difficult toil,
And battle on extinction’s perilous verge,
A clash of forces, a vast incertitude,
The joy of creation out of Nothingness.²⁸

The psychic being, or our own hidden self, can thus be understood as a ‘consenting agent’ of the Divine to effect the difficult and often painful, yet in its final analysis, blissful creative ‘union between God and Life towards which we tend.’²⁹ Consistent with this explanation, Sri Aurobindo notes that the psychic being takes up that physical, mental and emotional make up, including the circumstance and environment of its birth, or *karma*, which best suits its growth, which may involve suffering or misfortune. The challenges of building Auroville for its residents are, we can infer, part of that chosen and challenging journey. Having gained the necessary experience – which indeed is the sole testing ground for measuring growth, not necessarily success or failure –, the psychic being dissolves the outer personality at death, keeping with it only the essence of the experience, and prepares for the next embodiment with a new outer personality.

²⁶ Sri Aurobindo, CWSA, 1997, Vols. 21-22, 421.

²⁷ Sri Aurobindo, CWSA, 1997, Vols. 21-22, 1004-5.

²⁸ Sri Aurobindo, CWSA, 1997, Vols. 33-34, 455.

²⁹ Sri Aurobindo, CWSA, 1997, Vols. 21-22, 30.

This transmigratory framework, we may note in passing, has two important practical consequences when translated into Auroville's governance context. First, it allows one to place one's participation in the development of Auroville in perspective, as a corrective to the natural *tamaso-rajasic* spirit of possession, ownership and security that may hamper city-development. A growing self-identification with this scheme forms, as we discuss in the next section, the inner architecture of Auroville's productive arrangement in what Sri Aurobindo calls a Vedantic socialism. As the progressive shift from the false to true individualism obtains, so will problems attendant to *de facto* ownership be mitigated. And second, it has consequences for Auroville's entry policy, which we discuss in Part IV.E. In this transmigratory framework, as Professor Joshi notes, echoing Mother's words, Auroville is meant in the ideal for those who have already gone through the necessary preparatory experiences and experimentations that kindle the psychic spark, not before.³⁰ In Professor Joshi's interpretation of Mother's call to 'goodwill', Auroville becomes the space for *advanced* research, where the spiritual life obtains after mental and vital desires have, as they rightly should be, played out in their fulness:

And if you read *The Life Divine*, the very first paragraph of *The Life Divine* where the human aspiration has been described by Sri Aurobindo, he speaks of this very ideal, where he says that the earliest formula of wisdom also promises to be its last: God, Freedom, Bliss, Immortality. Same words, almost, have been repeated by Sri Aurobindo. In fact, this pursuit of these ideals is the very condition of divine life. And I personally believe that when Mother put down the word good will, it is not gentlemanliness, it is not good neighbourliness — that of course should be, that is understood. I always felt that Auroville is a field of advanced research, not only a field of research, but advanced research. And this, I think, people should make it very clear to everybody: that certain ordinary things have already been overpassed by the people who are here. They have tried, experimented many things. This is not a field of experimentation of fashions of life. There are many fashions going on. There are one fashion over here, another fashion over there, third fashion over there and some people, if they feel that they are now tired of one fashion and want to try another fashion and they come to Auroville and say that Auroville is a field of freedom and you can experiment with this fashion or that fashion, I personally would like to tell them very clearly, 'This is a field of advanced research.' That is to say you have already finished your journey with freely making experiments with various fashions of life. Having done it, now you have come to the conclusion that you want a higher and truer life. The very first proposition of the Mother is: we are aspiring for higher and truer life. If this decision has not been arrived at, it is incomplete, you are not yet ready to entry into Auroville, this is according to me. There are many other opinions and I am not speaking anything dogmatically, but this is how I reflect, when I reflect upon Mother's words.³¹

This ontological involution-evolution scheme, with the phisic being as the creative and redemptive nodus, is provided a practical rendering by Sri Aurobindo in the discussion on the 'yoga of self-perfection' in the *Synthesis of Yoga*. We can only touch upon the subject

³⁰ See, for example, Mother's lament that they 'they [some early residents] come here without experience, without knowledge, without preparation, and they think they are going to realise the Supermind right away ...' Guigan, 2018, Vol. 2, 234; see also, Guigan, 2018, Vol. 2, 360, *passim*. This is a constant refrain in Mother's comments at the time.

³¹ Joshi, 1999, 11.

superficially here, yet it is important to emphasize the detailing of a *method of practice* to accompany the ontological scheme.³² The practise proceeds on the substitution of the gross with the subtle – of troubled desire for Will or the psychic *pranic* force; of *citta* with its ‘mixed [and] inconstant colours of emotions’ for calm and clarity, on one hand, and ardent force and intensity, on the other; of doubt and conflict for unswerving faith, *kalyāna śraddhā*; of the intelligence and thinking mind, *buddhi* with its ‘obstructive narrowness’ and ‘intellectual unscrupulousness’ for a ‘pure and strong radiance emanating from the sun of Truth’.³³ This substitution, as one progresses, is achieved by the emergence of the psychic being, the embodied relation between the darkness of the Inconscient and the light of the Superconscient – ‘[when] we go higher, the relation is gradually reversed; it [the higher, ‘hidden’ state of being] is then able to act in its own power or handle the rest only as a subordinate instrumentation’.³⁴ The site of the ‘self-revealing’ of the cloaked Divine is the ego, the vehicle is the psychic being, the fuel is individual effort and the art is the Integral Yoga.

iii. *Ascent, Descent and the Synthesis*

Concluding our summary discussion, Sri Aurobindo outlines his scheme – arbitrating between the spiritual and material, with the psychic entity interposed as the vehicle of evolution – in the following words:

Since, then, we admit both the claim of the pure Spirit to manifest in us its absolute freedom and the claim of universal Matter to be the mould and condition of our manifestation, we have to find a truth that can entirely reconcile these antagonists and give to both their due portion in Life ... An Omnipresent Reality is the truth of all life and existence whether absolute or relative, whether corporeal or incorporeal, whether animate or inanimate, whether intelligent or unintelligent ... Brahman is the Alpha and Omega. Brahman is the One besides whom there is nothing else ... Spirit reveals itself through the same consenting agents as the soul, the truth, the essence of Matter. Both admit and confess each other as divine, real and essentially one. Mind and Life are disclosed in that illumination as at once figures and instruments of the supreme Conscious Being by which It extends and houses Itself in material form and in that form unveils Itself to Its multiple centres of consciousness. Mind attains its self-fulfilment when it becomes a pure mirror of the Truth of Being which expresses itself in the symbols of the universe; Life, when it consciously lends its energies to the perfect self-figuration of the Divine in ever-new forms and activities of the universal existence.³⁵

In this summative passage, Sri Aurobindo outlines the idea of his Integral Yoga as the panentheistic self-involution of the omnipresent Divine in the triple mode of material nature, with the interposition of an evolutionary psychic entity embedded in each person as the governing mechanism for the *līlā* of creation.³⁶ The panentheistic foundations of Sri Aurobindo and Mother’s thought – locating not only the Divine not only as an extra-cosmic creator, in its transcendent aspect, but as involved, in its imminent, yet veiled, aspect – gives to material life

³² Sri Aurobindo, CWSA, Vols. 23-24, Part IV.

³³ Sri Aurobindo, CWSA, 1997, Vols. 23-24, 29-30, 732-8.

³⁴ Sri Aurobindo, CWSA, 1997, Vols. 23-24, 29-30, 732.

³⁵ Sri Aurobindo, CWSA, 1997, Vols. 21-22, 29-30, 38.

³⁶ Sri Aurobindo, CWSA, 1997, Vols. 21-22, 1069.

a spiritual significance. If the Divine is all, then Matter too must be, such that the *telos* of our material evolution cannot be a liberation, or return, into the formless, blissful, unmanifest Divine (conceived variously in traditions), but a realization in matter. This critical movement marks a distinct addition to the spiritual landscape, marrying the intractable opposition between God and the world, *brahman* and *jagat*, *purusha* and *prakriti*.³⁷

For Sri Aurobindo, spiritual accounts with a non-material teleology (what we may call ‘liberation accounts’) ‘cut the Gordian knot of the problem of existence with one decisive blow and to accept an escape into an eternal bliss’,³⁸ rather than seeking for a ‘larger and completer affirmation’ of the Divine in Matter,³⁹ or a Divine Materialism. While Aurobindo admits the lure of this justified ‘spiritual enthusiasm’ of liberation accounts to ‘ascend into worlds of a greater consciousness beyond the earth’, which he terms an ‘indispensable element in human perfection’, his argument is directed against ‘the exaggeration of the ascetic impulse’ which ‘recoil[s] from the physical life’ and renders the manifested material world a ‘meaningless freak’ without Divine significance.⁴⁰ He notes, with a sympathetic yet ultimately disapproving nod to these liberation accounts, that:

The discord and apparent evil of the world must in their sphere be admitted, but not accepted as our conquerors. The deepest instinct of humanity seeks always and seeks wisely wisdom as the last word of the universal manifestation, not an eternal mockery and illusion, — a secret and finally triumphant good, not an all-creative and invincible evil, — an ultimate victory and fulfilment, not the disappointed recoil of the soul from its great [material] adventure.⁴¹

This distinct and crucial addition of terrestrial step to the evolutionary account of previous spiritual traditions is where Auroville’s founding ideal lies – to take on this epochal task at the collective level, solving the ‘riddle of the Immortal’s birth in Time’:

Earth is the chosen place of mightiest souls;
Earth is the heroic spirit’s battlefield,
The forge where the Archmason shapes his works.
Thy servitudes on earth are greater, King,
Than all the glorious liberties of heaven.⁴²

This account requires a deeper discussion on the link between Brahman, Purusha and Ishwara – Maya, Prakriti, Shakti,⁴³ but it is important to note in Auroville’s context that the ‘Mother’ in the Integral Yoga, the centripetal life-force of Auroville, is the Divine *shakti*, the manifesting power of the Brahman as Ishwara to undertake the terrestrial work.⁴⁴ Sri Aurobindo notes in relation to *shakti* and the physical manifestation of the Mother:

³⁷ Sri Aurobindo, CWSA, 1997, Vol. 17, 303. *See*, for a discussion, Medhananda, 2021, Medhananda, 2022. There is a body of literature critical of Sri Aurobindo’s thought as well, which is beyond our scope here yet important to address.

³⁸ Sri Aurobindo, CWSA, 1997, Vols. 21-22, 246.

³⁹ Sri Aurobindo, CWSA, 1997, Vols. 21-22, 27.

⁴⁰ Sri Aurobindo, CWSA, 1997, Vols. 21-22, 702-7.

⁴¹ Sri Aurobindo, CWSA, 1997, Vols. 21-22, 35; *see also*, 27, 42, 702, 706.

⁴² Sri Aurobindo, CWSA, Vols. 33-34, 1997, 686, 50.

⁴³ Sri Aurobindo, CWSA, Vols. 21-22, 1997, 336-379.

⁴⁴ *See*, Sri Aurobindo, CWSA, 1997, Vol. 32 and the treatment in *Savitri*, CWSA, Vols. 33-4, 60-6, 310-6.

All realities and all aspects and all semblances are the Brahman; Brahman is the Absolute, the Transcendent and incommunicable, the Supracosmic Existence that sustains the cosmos, the Cosmic Self that upholds all beings, but It is too the self of each individual: the soul or psychic entity is an eternal portion of the Ishwara; it is his supreme Nature or Consciousness-Force that has become the living being in a world of living beings. The Brahman alone is, and because of It all are, for all are the Brahman; this Reality is the reality of everything that we see in Self and Nature. Brahman, the Ishwara, is all this by his Yoga-Maya, by the power of his Consciousness Force put out in self-manifestation: he is the Conscious Being, Soul, Spirit, Purusha, and it is by his Nature, the force of his conscious self-existence that he is all things; he is the Ishwara, the omniscient and omnipotent All-ruler, and it is by his Shakti, his conscious Power, that he manifests himself in Time and governs the universe. These and similar statements taken together are all-comprehensive: it is possible for the mind to cut and select, to build a closed system and explain away all that does not fit within it; but it is on the complete and many-sided statement that we must take our stand if we have to acquire an integral knowledge.⁴⁵

The One whom we adore as the Mother is the divine Conscious Force that dominates all existence, one and yet so many-sided that to follow her movement is impossible even for the quickest mind and for the freest and most vast intelligence. The Mother is the consciousness and force of the Supreme and far above all she creates. But something of her ways can be seen and felt through her embodiments and the more seizable because more defined and limited temperament and action of the goddess forms in whom she consents to be manifest to her creatures.⁴⁶

We provide below a rough and simplified diagrammatic representation of our summary reconstruction of Sri Aurobindo's thought.

⁴⁵ Sri Aurobindo, CWSA, Vols. 21-22, 1997, 339.

⁴⁶ Sri Aurobindo, CWSA, Vol. 32, 14.

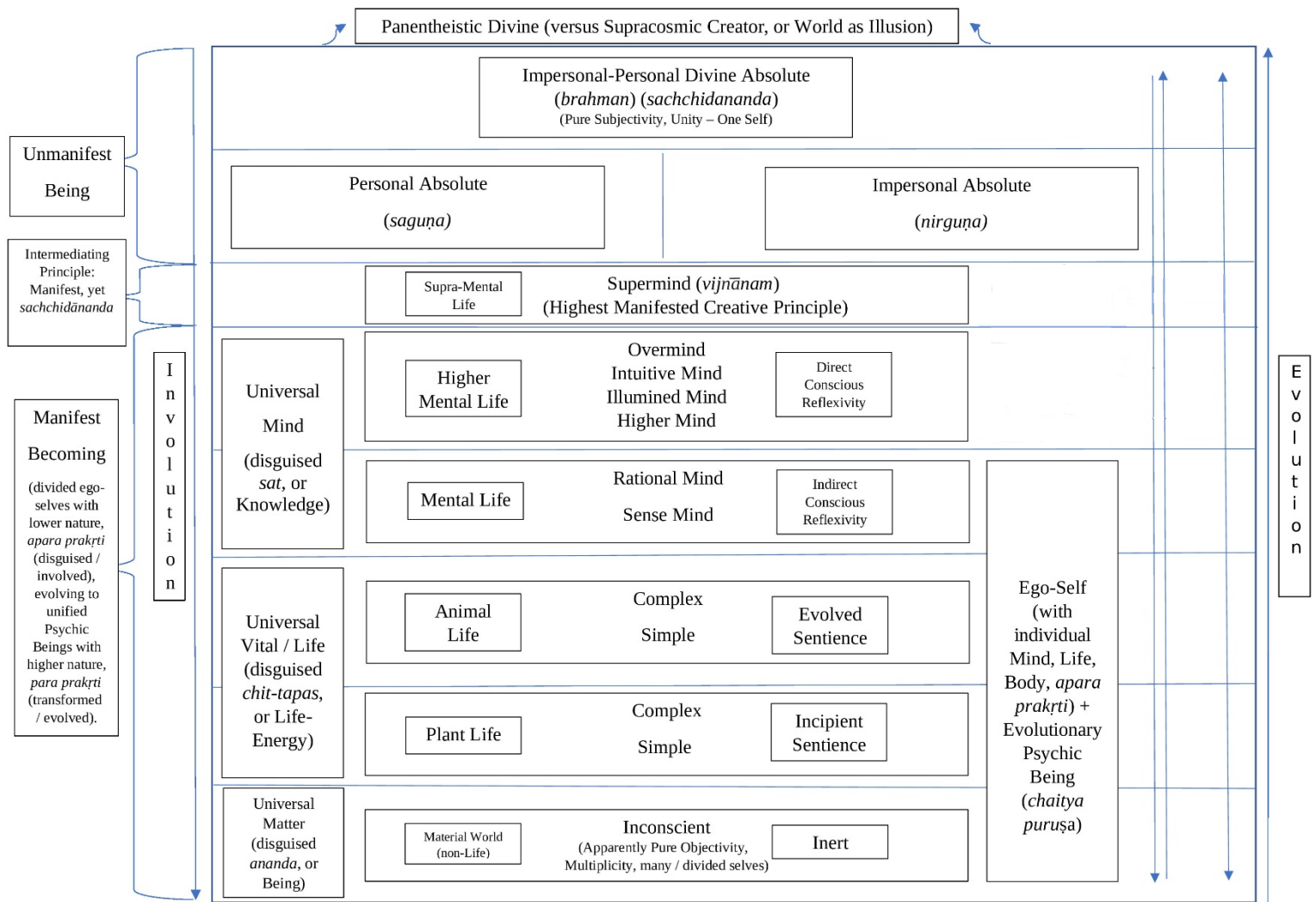

(Simplified Representation of Sri Aurobindo's Evolutionary Scheme)

Our suffering – or in the Auroville context, the problems of disharmony in collective organization – then is ‘a consequence of the limitation of consciousness’.⁴⁷ This is engendered (at a general level) by the Divine self-involution and self-identification with Nature, and (for those drawn to the Mother, a voluntary and experientially driven fact, not an enforced one) by an insufficient identification with Her Presence.⁴⁸ The move from this self-involution identification with the ego to the individual psychic entity and the collective ‘group-soul’ of Auroville, moving inwards and close to the Divine element in us, manifest in various forms, for many as the Mother, constitutes the evolutionary journey in the Integral Yoga. This formulation implies that so long as we are party to this wrong identification with *maya* of *prakṛti*, or the real, but not essential, delusion of being separate selves, cut off from our true nature as being one with *brahman*, which is the ultimate underlying reality, our suffering is necessary and required as means of our spiritual growth. Indeed, it is *constitutive* of the play:

I used to hate and avoid pain and resent its infliction; but now I find that had I not so suffered, I would not now possess, trained and perfected, this infinitely and multitudinously sensible capacity of delight in my mind, heart and body. God justifies himself in the end even when He has masked Himself as a bully and a tyrant.

...

When I suffer from pain or grief or mischance, I say ‘So, my old Playfellow, thou hast taken again to bullying me,’ and I sit down to possess the pleasure of the pain, the joy of the grief, the good fortune of the mischance; then He sees He is found out and takes His ghosts and bugbears away from me.⁴⁹

In his *Synthesis of Yoga*, Sri Aurobindo traces the three distinct steps of our ascension, rising from the apparently ‘undivine’ (in reality, veiled) status of our embodied existence to fullness of the Divine *sachchidānanda*, manifested in the force of Light, Power, Beauty and Perfection, each embodied in the four-fold physical manifestation of the Divine Mother:

The human soul’s individual liberation and enjoyment of union with the Divine in spiritual being, consciousness and delight must always be the first object of the Yoga; its free enjoyment of the cosmic unity of the Divine becomes a second object; but out of that a third appears, the effectuation of the meaning of the divine unity with all beings by a sympathy and participation in the spiritual purpose of the Divine in humanity. The individual Yoga then turns from its separateness and becomes a part of the collective Yoga of the divine Nature in the human race. The liberated individual being, united with the Divine in self and spirit, becomes in his natural being a self-perfecting instrument for the perfect out flowering of the Divine in humanity.⁵⁰

The ‘first object’ of his spiritual scheme is the individual liberation of the old yogas, *jñāna*. The ‘second object’ is the realization of the ‘cosmic unity of the Divine,’ or *viññāna*. But where the earlier disciplines stop (and escape into higher states), Sri Aurobindo notes that ‘out of that’ appears a third object, his distinct addition to the spiritual landscape, ‘the collective Yoga of

⁴⁷ Sri Aurobindo, CWSA, Vols. 21-22, 1997, 420.

⁴⁸ We discuss the place of Mother and Sri Aurobindo’s thought and practice in Part IV.E, to highlight the important of a culture of seeking, rather than religious dogmatism, on one hand, and an easy rejection, on the other.

⁴⁹ Sri Aurobindo, CWSA, Vol. 12, 1997, 490, 492.

⁵⁰ Sri Aurobindo, CWSA, Vols. 23-24, 1997, 613-4.

the divine Nature in the human race.’ This third step – a terrestrial conclusion to the spiritual journey in a gnostic race, or a transformation of physical matter through the descent of the Supramental – is Mother and Sri Aurobindo’s unique addition to the spiritual landscape.⁵¹ This reconciliation of the quetistic and dynamic parts of our being, the opening articulation of the *Life Divine*, places before us the ideal of Auroville.⁵² Writing to the Mother in 1915, Sri Aurobindo put it in the synthetic tenor of the Veda:

Heaven we have possessed, but not the earth; but the fullness of the Yoga is to make, in the formula of the Veda, ‘Heaven and Earth equal and one.’

The crucial third step, following on from the first two (not leapfrogging them), indeed what makes his yoga *pūrṇa* or integral, is the reconciliation of Matter with Spirit, the founding tenet of Auroville. This is a radical, and not lightly accepted, advance on previous traditions that requires a far fuller discussion and offers fertile ground for comparative research in Auroville’s tertiary research infrastructure as we discuss in Part III.E. We present a brief summary of Sri Aurobindo’s view, as a response to world-denying, ascetic or illusionistic traditions (we use these words loosely and interchangeably), insofar as it informs Auroville’s material works.

iv. Advance on Previous Traditions

If the *telos* of the soul’s material embodiment, howsoever occasioned, is a liberation, or escape, into its pre-existent freedom in the Divine *sachchidānanda*: this leaves both the original purpose of the material manifestation and its subsequent status post universal salvation unexplained. Sri Aurobindo formulates the problem as follows:

If his inexorable removal through the very act of illumination is the law, then the world is condemned to remain eternally the scene of unredeemed darkness, death and suffering. And such a world can only be a ruthless ordeal ...⁵³

In placing past ascetic traditions, with their noble and mighty realizations (not to be cast aside easily), in his crosshairs, he pushes this point further:

It is so that ascetic philosophy tends to conceive it. But individual salvation can have no real sense if existence in the cosmos is itself an illusion. In the Monistic view the individual soul is one with the Supreme, its sense of separateness an ignorance, escape from the sense of separateness and identity with the Supreme its salvation. But who then profits by this escape? Not the supreme Self, for it is supposed to be always and inalienably free, still, silent, pure. Not the world, for that remains constantly in the bondage and is not freed by the escape of any individual soul from the universal Illusion. It is the individual soul itself which effects its supreme good by escaping from the sorrow and the division into the peace and the bliss.⁵⁴

⁵¹ This graded ascent through the Higher Mind, Illumined Mind, Intuitive Mind and Overmind is carefully detailed by Sri Aurobindo. This is beyond our scope here, but as we note in Part III, the graded scheme is relevant to anchor discussions on realizing the Supramental ideal to avoid a rash leap.

⁵² See, the opening dynamic between the ‘materialist denial’ and the ‘refusal of the ascetic’ in Sri Aurobindo, CWSA, Vols. 21-22, 1997, 8-28.

⁵³ Sri Aurobindo, CWSA, Vols. 21-22, 1997, 43.

⁵⁴ Sri Aurobindo, CWSA, Vols. 21-22, 1997, 43.

Simply put, spiritual profit in such an ‘escape’ is gained neither by the Absolute nor the world, but only, it at all, by the individual soul. But this too is unappealing, for immutable soul remains, by definition, unchanged by its descent and participation in the world, and thus only occasions needless suffering for our ego-selves: ‘For my part, I think I have a right to insist on God giving Himself to me in the world as well as out of it. Why did He make it at all, if He wanted to escape that obligation?’⁵⁵

Sri Aurobindo’s writing on this point is emphatic and characteristically piercing: he equates such a non-life-affirming view to ‘... the laws of a cosmic madhouse’.⁵⁶ He notes:

... so long as we are mad and have to remain in the madhouse, we are perforce subject to its rules and we must make, according to our temperament, the best or worst of them, but always our proper aim is to get cured of our insanity and depart into light and truth and freedom. Whatever mitigations may be made in the severity of this logic, whatever concessions validating life and personality for the time being, yet from this view-point the true law of living must whatever rule can help us soonest to get back to self-knowledge ... the true ideal must be an extinction of the individual and the universal, a self-annulment in the absolute.⁵⁷

Thus, Sri Aurobindo argues that if our ‘proper aim’ is to depart, or more evocatively, ‘get cured from this insanity’ of the embodied manifestation, such that liberation implies an extinction of the individual into the Absolute, then our suffering remains insufficiently explained.⁵⁸ Following the train of his thought, if ‘we ... suppose’, as many accounts do, a ‘preterrestrial existence of the soul, a fall or descent into matter and a reascension into celestial being’, we shall ‘see in it a place of ordeal, a field of development ...’, where ‘through a protracted series of births ... it [the soul] is destined to reascend at last into the proper plane of the Divine Being and there enjoy an eternal proximity and communion.’⁵⁹ This idea of the soul’s ‘sojourn on earth as a temporary passage or a department from its highest eternal nature and of a heaven beyond as its proper habitation’ leads us, in Sri Aurobindo’s view to an world-view that ‘emphasi[z]es ... the development of the ethical and spirit being as the mean of ascension and therefore the one proper business of life in this world of matter.’⁶⁰ This however translates into an ‘escape’ from ‘the meaningless tangle of phenomenal life’ as the ‘sole rational’ option available to us such that ‘we need ... to give up the bodily life to attain to the ... spiritual’. Taking this to its logical conclusion, if the *telos* of the soul’s material embodiment is a liberation, or escape, into its pre-existent freedom in the Divine *sachchidānanda*, this leaves both the original purpose of the material manifestation and its subsequent status post universal salvation unexplained. Sri Aurobindo paints the darkness at the end of this tunnel:

If his inexorable removal through the very act of illumination is the law, then the world is condemned to remain eternally the scene of unredeemed darkness, death and suffering. And such a world can only be a ruthless ordeal ...⁶¹

⁵⁵ Sri Aurobindo, CWSA, Vol. 12, 1997, 483.

⁵⁶ Sri Aurobindo, CWSA, Vols. 21-22, 1997, 694.

⁵⁷ Sri Aurobindo, CWSA, Vols. 21-22, 1997, 694-5.

⁵⁸ Sri Aurobindo, CWSA, Vols. 21-22, 1997, 694.

⁵⁹ Sri Aurobindo, CWSA, Vols. 21-22, 1997, 699.

⁶⁰ Sri Aurobindo, CWSA, Vols. 21-22, 1997, 700.

⁶¹ Sri Aurobindo, CWSA, Vols. 21-22, 1997, 43.

As a response to this view, his panentheistic and life-affirming ('integral') conclusion culminating in a descent of the Supramental, not only the ascent of the soul, thus follows:

... mortal existence can have no base unless we recognise not only eternal Spirit as the inhabitant of this bodily mansion, the wearer of this mutable robe, but accept Matter of which it is made, as a fit and noble material out of which He weaves constantly His garbs, builds recurrently the unending series of His mansions.⁶²

Similarly, Mother notes:

The old spirituality was an escape from life into the divine Reality, leaving the world just where it was, as it was; whereas our new vision, on the contrary, is a divinisation of life, a transformation of the material world into a divine world.⁶³

In doing so, Sri Aurobindo and Mother attempt to reconcile the old warring enemies, matter and spirit, the 'refusal of the ascetic' and the 'denial of the materialist', each claiming universal dominion to the exclusion of the other. For long, a schismatic divide that put one to a terrible choice, between a life devoted to God and to the world, was *de rigueur*: 'He who would turn to God, must leave the world; He who would live in the Spirit, must give up life'.⁶⁴ In synthesizing this false yet, for eminently good reasons, persistent dichotomy, Sri Aurobindo and Mother's Integral Yoga charts a new terrain. There is perhaps no better call to this 'adventure of consciousness' than Mother's message of 21st August, 1957, a few years before she set upon the journey to realize Auroville:

We are now witnessing the birth of a new world; it is very young, very weak – not in its essence but in its outer manifestation – not yet recognised, not even felt, denied by the majority. But it is here. It is here, making an effort to grow, absolutely sure of the result. But the road to it is a completely new road which has never before been traced out – nobody has gone there, nobody has done that. It is a beginning, a universal beginning. So, it is an absolutely unexpected and unpredictable adventure. There are people who love adventure. It is these I call, and I tell them this: 'I invite you to the great adventure.'

It is not a question of repeating spiritually what others have done before us, for our adventure begins beyond that. It is a question of a new creation, entirely new, with all the unforeseen events, the risks, the hazards it entails – a real adventure, whose goal is certain victory, but the road to which is unknown and must be traced out step by step in the unexplored.⁶⁵

v. *Caution on Prematurity*

While the descent of the Supramental is the end goal of evolution in Sri Aurobindo and Mother's vision, and indeed Auroville's foundational ideal and final destination, it is important to emphasize the long, arduous and persistent effort that *precedes* this stage. We encountered

⁶² Sri Aurobindo, CWSA, Vols. 21-22, 1997, 8.

⁶³ Guigan, 2018, Vol. 1, 63.

⁶⁴ Sri Aurobindo, CWSA, Vols. 33-34, 1997, 661. This has serious implications for practice, *see*, Mother, CWM, 2002, Vol. 4, 358-9.

⁶⁵ Guigan, 2018, Vol. 1, 64-5.

in several conversations a discussion of the Supramental being or the Gnostic society as Auroville's ideal, yet with an under-emphasizing of the prior steps. These, we must underscore, are *epochal* events in the truest sense of the term – their implications may be easily stated in intellectual terms or romantically eulogized in high prose, yet their true meaning at the level of realization, of experience, is momentous.⁶⁶ They require a mighty labour, one that demands utter sincerity, a ruthless purification of desire and complex webs of the self and an entire and unreserved surrender amidst the fulness and intensity of life – the complex and daring journey of *Savitri*:

All Nature's recondite spaces were stripped bare,
All her dim crypts and corners searched with fire
Where refugee instincts and unshaped revolts
Could shelter find in darkness' sanctuary
Against the white purity of heaven's cleansing flame.

...

Then lest a human cry should spoil the Truth
He tore desire up from its bleeding roots
And offered to the gods the vacant place.⁶⁷

This is important to state in such terms to avoid an alluring yet dangerously premature rhetoric in the public sphere: as Sri Aurobindo repeatedly counselled, great caution must be had against a bypassing of careful and rigorous mental, vital and physical development – in itself a great task – which in time leads to a psychic touch, growth and finally emergence, progressively illuminating the instrumental nature, all of which in turn forms the basis for the later, and higher, spiritual and finally, in the culminating movement, Supramental realization.⁶⁸ Each stage is an 'unavoidable preparation' for the next.⁶⁹ For example, he notes:

The aspiration for the supramental would be premature. What you have to aspire for is for the psychic change and the spiritual change of the whole being – which is the necessary condition before *one can even think* of the supramental.

To want to be a superman is a mistake, it only swells the ego.

One can aspire for the Divine to bring about the supramental transformation, but that also should not be done till the being has become psychic and spiritualised by the descent of the Mother's peace, force, light and purity.⁷⁰

But if any *shadow of egoism* falls over this endeavour [the Divine *sangha* or community], then the Sangha will change into a sect. The idea may very naturally

⁶⁶ This is as crucial as it is subtle a point that requires a detailed treatment beyond the scope of our study here – indeed, the advent of the new species, the Supramental or intermediary being, is a matter to be dealt with and spoken of with extreme care and due weight. *See, See*, Griffiths and Sethna, 2004, 32.

⁶⁷ Sri Aurobindo, CWSA, Vols. 33-34, 1997, 317-8.

⁶⁸ Sri Aurobindo, CWSA, Vol. 29, 1997, 207-8. This is a naturally a quick and superficial description of a complex inner movement – our purpose here is simply to register the depth and moment of the task at hand, rather than enter the complexity of the terrain.

⁶⁹ Griffiths and Sethna, 2004, 73.

⁷⁰ Sri Aurobindo, CWSA, 1997, Vol. 29, 56-7.

creep in that such and such a body is the one true Sangha of the future, the one and only centre, that all else must be its circumference, and that those outside its limits are not of the fold or even if they are, have gone astray, because they think differently. [a point of note in Auroville insofar as an exceptionalist self-definition results, as we discuss in Part IV.E].⁷¹

The triple labour of aspiration, rejection and surrender, the silencing of the mind and the vital, an opening to the physic touch and the complex line of movements that accompany the long and minute discipline – the subject of the *Synthesis of Yoga*, discussed in Sri Aurobindo's *Letters on Yoga* and Mother's works – thus precede any attempt at, or we may suggest, even talk of the exalted Supramental. A 'large and strong equanimity', a 'calm, peace and surrender', are the 'true foundation', absent which, 'all these 'experiments' of yours', Sri Aurobindo once reminded a disciple, 'are founded upon the vital nature and the mind in connection with it'.⁷² 'Working on this foundation', he said, 'there is no security against falsehood and *fundamental* error.'⁷³ Similarly, absent a sufficient base of purification and development of the personality, as Mother repeatedly noted, the risk of the expansive tendencies of the ego disguising themselves in a spiritual ideal are all too real.

There are those who pretend that all they want is to serve the Divine but the ego rests 'gros – gros – gros' (big-big-big).⁷⁴

Indeed, Mother's blunt remarks on this issue in relation to some early members of the community are striking:

They don't understand a thing. Even in Auroville they're like that, they don't understand ... they come here without experience, without knowledge, without preparation, and they think they are going to realise the Supermind right away ... It's really pathetic.⁷⁵

Haven't I already said that the Aurovilians have to work according to the supramental discipline?

[S.: Yes, Mother, but they say that regular work is not the supramental way.]

Do they know the supramental?

[S.: One doesn't know, even the illumined mind, but pretends about the supramental]

... Those who want to obey their ego and satisfy all their desires belong to a sub-humanity and have no place here. They must return to the world which is their true place ... As long as they have desires, they are not true Aurovilians.⁷⁶

The height of the supramental ideal must thus be preceded by a long and patient climb – the 'traveller of the world-stairs' – through the path of works, knowledge and love to transform

⁷¹ Guigan, 2018, Vol. 1, 27 (emphasis ours).

⁷² Sri Aurobindo, CWSA, 1997, Vol. 28, 573. *See generally*, Sri Aurobindo, CWSA, 1997, Vol. 29, 162, *passim*.

⁷³ Sri Aurobindo, CWSA, 1997, Vol. 28, 573 (emphasis ours).

⁷⁴ Guigan, 2018, Vol. 1, 246.

⁷⁵ Guigan, 2018, Vol. 2, 234.

⁷⁶ Guigan, 2018, Vol. 2, 429, 436.

desire, illumine the mind and all that lies beyond. The ‘principal condition’ of the yoga of ‘self-perfection’, Sri Aurobindo notes, are:

... will, self-watching and self-knowledge and a constant practice, *abhyāsa*, of self-modification and transformation. The Purusha has that capacity; for the spirit within can always change and perfect the working of its nature. But the mental being must open the way by a clear and a watchful introspection, an opening of itself to a searching and subtle self-knowledge which will give it the understanding and to an increasing extent the mastery of its natural instruments, a vigilant and insistent will of self-modification and self-transformation — for to that will the Prakriti must with whatever difficulty and whatever initial or prolonged resistance eventually respond, — and an unflinching practice which will constantly reject all defect and perversion and replace it by right state and a right and enhanced working. *Askesis*, *tapasya*, patience and faithfulness and rectitude of knowledge and will are the things required until a greater Power than our mental selves directly intervenes to effect a more easy and rapid transformation.⁷⁷

Accordingly, as we note in Section IV.A in reference to existing institutional practices, a premature leapfrog in the name of a ‘Divine anarchy’ carries the risk of its precise opposite, human anarchy, a ‘vital subjectivism’ in the name of spiritual seeking. It also bears mentioning here that the perhaps natural tendency to pietistically repeat Mother and Sri Aurobindo’s words, or the goal to which they point, is, in the least, unhelpful and in the extreme, deceptive. As we briefly discuss in Part IV.E, it is experience – neither belief and pious repetition, nor emotional and mental ‘bubbling’, as Mother once called it, couched in spiritual terms – that in the end alone matters. This is a subject that demands much greater attention and detail – indeed it is the very core of the practice of Auroville’s communal yoga that cannot be subject to easy, quick or generic inquiry; yet we may only register the caution here that speaking of the Supramental yoga or Gnostic being or society, while alluring and noble, ought to be carefully weighed. As Mother wisely counselled, ‘little by little it will be revealed to us ... and meanwhile, the best course is to consecrate oneself entirely to the Divine.’⁷⁸

vi. Caution on Rejection

While Sri Aurobindo and Mother’s distinct advance on previous traditions sets them apart, it is not mutually exclusive with them. It is particularly importantly here to clarify the placement of the Integral Yoga with previous spiritual paths, as the records at times indicate an unhealthy dismissal of ‘what others are doing.’⁷⁹ As Sri Aurobindo emphasized, caution must be had with an easy exceptionalism or superiority. Insofar as other traditions go, the path of the Integral Yoga is not inconsistent with other spiritual disciplines. As Sri Aurobindo notes, with a broad sweep of references to a range of traditions, that this project – notably, the Divine’s project, not his personal sectarian project – was anticipated by past thought:

⁷⁷ Sri Aurobindo, CWSA, Vols. 23-24, 739; *see*, 732-739 for a detailed discussion.

⁷⁸ Mother, 1970, para. 6.

⁷⁹ This applied both to other spiritual paths and the ‘ordinary’ life elsewhere, a not uncommon refrain in the records and our interviews.

It is a keen sense of this possibility which has taken different shapes and persisted through the centuries, — the perfectibility of man, the perfectibility of society, the Alwar’s vision of the descent of Vishnu and the Gods upon earth, the reign of the saints ... the city of God, the millennium, the new heaven and earth of the Apocalypse.⁸⁰

Sri Aurobindo does not reject the lofty ascetic realizations – the contrary, as we noted above, he considers them the *foundation* of his yoga. Rather, he considers them partial, ‘half (though exalted) Knowledge’:

Ignorance means Avidya, the separative consciousness and the egoistic mind and life that flow from it and all that is natural to the separative consciousness and the egoistic mind and life. This Ignorance is the result of a movement by which the cosmic Intelligence separated itself from the light of the Supermind (the divine Gnosis) and lost the Truth, – truth of being, truth of divine consciousness, truth of force and action, truth of Ananda. As a result, instead of a world of integral truth and divine harmony created in the light of the divine Gnosis, we have a world founded on the part truths of an inferior cosmic Intelligence in which all is half-truth, half-error. It is this that some of the ancient thinkers like Shankara, not perceiving the greater Truth-Force behind, stigmatised as Maya and thought to be the highest creative power of the Divine. All in the consciousness of this creation is either limited or else perverted by separation from the integral Light; even the Truth it perceives is only a half-knowledge.⁸¹

Given the place previous spiritual disciplines occupy in his own project, Sri Aurobindo repeatedly emphasizes that they are worthy of deep reverence and not to be cast aside. He calls ‘depreciation of the old Yogas as something quite ... worthless and evidently absurd on the face it.’⁸² In a letter dated 13 April, 1936, he responds emphatically to a disciple’s comment that the ‘old yogas stopped short at self-realization, which is not a very difficult stage’:

Wonderful! The realisation of the Self which includes the liberation from ego, the consciousness of the One in all, the established and consummated transcendence out of the universal Ignorance, the fixity of the consciousness in the union with the Highest, the Infinite and Eternal is not anything worth doing or recommending to anybody — is ‘not a very difficult stage’!

From where did you get this singular attitude towards the old Yogas and Yogis? Is the wisdom of the Vedanta and Tantra a small and trifling thing? I have said that this Yoga was ‘new’ because it aims at a change in this world and not only beyond it and at a supramental realisation. But how does that justify a superior contempt for the spiritual realisation *which is as much the aim of this Yoga as of any other?*⁸³

He goes on to note the affinities between his thought and past spiritual practice:

I know very well also that there have been seemingly allied ideals and anticipations — the perfectibility of the race, certain Tantric sadhanas, the effort after a complete

⁸⁰ Sri Aurobindo, CWSA, Vols. 21-22, 1997, 503.

⁸¹ Sri Aurobindo, CWSA, Vols. 28-31, 1997, 451.

⁸² Sri Aurobindo, CWSA, Vols. 28-31, 1997, 415.

⁸³ Sri Aurobindo, CWSA, Vols. 28-31, 1997, 415-6 (emphasis ours).

physical Siddhi by certain schools of Yoga, etc. etc. I have alluded to these things myself and have put forth the view that the spiritual past of the race has been a preparation of Nature not merely for attaining to the Divine beyond the world, but also for the very step forward which the evolution of the earth-consciousness has now to make.

But ‘these intuitions,’ he notes, ‘lacked a basis of assured knowledge.’ Had ‘I ... found this method or anything like it in its totality proposed or realised in the old Yogas,’ Sri Aurobindo says,

I should not have wasted my time in hewing out a road and in thirty years of search and inner creation when I could have hastened home safely to my goal in an easy canter over paths already blazed out, laid down, perfectly mapped, macadamised, made secure and public.

I have never said that my Yoga was brand new in all its elements. I have called it the integral Yoga and that means that it takes up the essence and many procedures of the old Yogas — its newness is in its aim, standpoint and the totality of its method ... There is nothing in it that distinguishes it from the old Yogas except the aim underlying its comprehensiveness, the spirit in its movements and the ultimate significance it keeps before it ...⁸⁴

Sri Aurobindo thus does not resist the realizations of earlier spiritual traditions, but only the claim of finality that is attached to them.⁸⁵ The ‘final sense of the earth evolution’ must instead trace the involutionary logic of Vedanta to its conclusion: the evolution, or emergence, of the self-concealed Spirit in Matter through the descent of the Supramental – in other words, a yet unachieved integral panentheism, where the Divine is in and of the world, in matter, and not a supracosmic creator outside it or one to which the soul must *return* by salvation:

As there has been established on earth a mental Consciousness and Power which shapes a race of mental beings and takes up into itself all of earthly nature that is ready for the change, so now there will be established on earth a gnostic Consciousness and Power which will shape a race of gnostic spiritual beings and take up into itself all of earth-nature that is ready for this new transformation.⁸⁶

This open and welcoming orientation to other traditions, spiritual and temporal, is encapsulated in Mother’s call:

Auroville wants to be the bridge between the past and the future. Taking advantage of all discoveries... All discoveries, you know: philosophical, spiritual, moral, scientific, all – taking advantage of the past ... of all discoveries from without and from within, it wants to boldly spring towards future realizations.⁸⁷

⁸⁴ Sri Aurobindo, CWSA, Vols. 28-31, 1997, 401-2.

⁸⁵ For a discussion on the practical implications of this idea, a renunciation of life for personal salvation as opposed to earthly realization, *see*, Sri Aurobindo, CWSA, Vols. 23-24, 324-8.

⁸⁶ Sri Aurobindo, CWSA, Vols. 21-22, 1997, 1002. Amal Kiran’s incisive short exchange on the uniqueness of Sri Aurobindo’s *yoga* in comparison with previous traditions serves to clarify this issue. *See*, Griffiths and Sethna, 2004, 32-4, 8-14, *passim*. Amal Kiran’s voluminous output in general offers fertile ground for research in Auroville, that we hope may be taken up in time.

⁸⁷ Guigan, 2018, Vol. 1, 241.

This subject naturally merits a far deeper examination, yet the essential push to inclusivism and openness towards other traditions, and a rejection of easy exceptionalism or superiority, is important to place at the fore.

vii. *Auroville in Perspective*

This all too brief reconstruction of Sri Aurobindo's thought is necessary to place Auroville's establishment in a broad historical and philosophical perspective. In a sense, historically, the idea of Auroville does not begin with the 'A Dream' in 1954, or the 1968 Charter, nor is it simply a reaction to the environmental and economic crises of the time. Rather, Auroville is envisioned as the playground for the manifestation of the evolutionary spiritual impulse in matter, of which the long 'past ... has been a preparation.'⁸⁸ This long time-scale grounds the ideal of Auroville, against which its progress is to be measured, and offers a stable framework to guard against reactionary developments to temporary stresses and shifts of the day. And philosophically, as Mother noted, Auroville is a place for the practice of Sri Aurobindo's life-affirming Integral Yoga. The panentheistic foundation of the discipline thus mandates that *all* activities be taken up and represented in the collective, without shrinking, and equally, that a public culture support a seeking engagement with the discipline. Particularly, general references to 'growth of consciousness' or 'inner work', common in our conversations, must be informed by Sri Aurobindo and Mother's careful deconstruction of the vast landscape that falls within those phrases. Collectively speaking, Auroville's social charter is detailed in Sri Aurobindo's description of the 'advent of the spiritual age' in *The Human Cycle*, the evolutionary culmination of a concentrated and integral movement – in politics, art, urban planning, education, ethics, philosophy, commerce and industry and all provinces of human life – to embody the progressive descent of the Spirit.⁸⁹ This 'dynamic re-creation of the individual manhood in the spiritual type', in a collective and life-affirming urban setting, is the ideal of Auroville, no less daunting than it is extraordinary.⁹⁰ Auroville, in this perspective, is a place for advanced research works, advancing upon and integrating the previous and necessary stages in the cycle, from which one has already graduated after a full play of life, to be a leader in the march to the New Creation, yet to be born and indeed, incredulous to most. In the final analysis, it is this 'supreme and difficult labour', a manifestation of the Divine in all spheres of collective life, that Auroville is to engage and against which its value and success is to be measured.⁹¹ If Sri Aurobindo's integral panentheism is to be proven true, Auroville cannot but then accept any and all challenges to an effective manifestation, to make real that 'far-off promise' of the unveiling of the 'unseen and unguessed' Spirit *here and now*, as a guide to collectives elsewhere.⁹²

In the context of Auroville, this yoga is translated – in the spirit of the famous epigram to the *Synthesis of Yoga*, 'all life is yoga' – into the four essential aspects of the Divine's

⁸⁸ Sri Aurobindo, CWSA, Vols. 21-22, 1997, 1096.

⁸⁹ Sri Aurobindo, CWSA, 1997, Vol. 25, 261-277.

⁹⁰ Sri Aurobindo, CWSA, 1997, Vol. 25, 262.

⁹¹ Sri Aurobindo, CWSA, 1997, Vol. 25, 267.

⁹² Sri Aurobindo, CWSA, 1997, Vol. 25, 269.

manifestation, which encompass all areas of activity: Wisdom (*maheshwari*), Strength (*mahakali*), Harmony (*mahalakshmi*) and Perfection (*mahasaraswati*). Each principle is in turn manifested in the spatial context of the city-plan in Mother's vision discussed below such that the material task of city-building, in all its tangible and intangible measures, is a space for the expression of the highest spirit in material form. As we discuss below, this belies any distinction between 'city-building' and 'man-building', a rhetorical divide that has hampered action.

*

C. A COMMITMENT TO COLLECTIVE YOGA AND PROGRESSIVE FRATERNITY

The second cornerstone of Sri Aurobindo and Mother's thought is a recognition of the collective yoga, a communal, and not only individual, ascension to the Spirit. As Sri Aurobindo notes:

It is true that the spiritual tendency has been to look more beyond life than towards life. It is true also that the spiritual change has been individual and not collective; its result has been successful in the man, but unsuccessful or only indirectly operative in the human mass. The spiritual evolution of Nature is still in process and incomplete, – one might almost say, still only beginning, – and its main preoccupation has been to affirm and develop a basis of spiritual consciousness and knowledge and to create more and more a foundation or formation for the vision of that which is eternal in the truth of the spirit. It is only when Nature has fully confirmed this intensive evolution and formation through the individual that anything radical of an expanding or dynamically diffusive character can be expected or any attempt at collective spiritual life, – such attempts have been made, but mostly as a field of protection for the growth of the individual's spirituality, – acquire a successful permanence ...⁹³

This dynamic of the tension between the development of a collective and individual life is explored at length in Sri Aurobindo's *Human Cycle* and *The Ideal of Human Unity*. In these works, Sri Aurobindo presents a novel application of his Vedantic scheme to problems of collective organization. As such, they provide a detailed roadmap for Auroville. While time and space limit a detailed study, a brief reconstruction is helpful to understand the vision, and for our discussion of Auroville's governance in Part III.⁹⁴ A close and careful mapping of Auroville's current evolution and current state to the *Human Cycle* and *Ideal of Human Unity* is an important and urgent research project – it is yet un-attempted, or at least unwritten, to the best of our knowledge. The practical design of governance systems in Auroville can be helpfully anchored in this exercise.

i. The Scheme of Political Vedantism

Sri Aurobindo's discussion charts a teleological progression of societies in time, from what he calls the 'symbolic' age to the 'typal' and 'conventional' ages, and finally, to the 'age of reason' and the 'age of spirituality'. Each stage has its characteristic forms of organization between the individual and the collective.⁹⁵ In delineating these stages, Sri Aurobindo employs the *sāṃkhya* theory of the three *gunas* or psychological modes, to relate the socio-political movements to the underlying spiritual evolution. This would again require a fuller discussion than we can offer here, yet the outline is relevant to understand the dynamics in Auroville and anticipate future movements.⁹⁶

⁹³ Sri Aurobindo, CWSA, Vols. 21-22, 1997, 918.

⁹⁴ For helpful introductions, see, Chikermane and Ganguli, 2022, Chs. 20-21.

⁹⁵ See, Sri Aurobindo, CWSA, 1997, Vol. 25, 5-34; 102-123, 182-231; CWSA, 1997, Vol. 17, 285-299. Sri Aurobindo's intricate discussion on this point, which we outline below, ties to long-standing debates between 'liberals' and 'communitarians', a literature with which comparative research in Auroville can be helpful. See, for example, Sandel (ed.), 1984; Taylor, 1985, Vol. 2, 181-203; MacIntyre, 1984; Guttman, 1985.

⁹⁶ See, for a perceptive reconstruction of Sri Aurobindo's 'Political Vedantism', Varma, 1957.

Briefly, Sri Aurobindo argues that the rise of democracy and individualism reflects a growing evolution of the *rajasic* or kinetic, 'vital' and enterprising psychological modality that demands individual freedom and growth. This itself evolves from the *tamasic* or inertia-laden modality that grounded an early-stage conservatism where the individual was subjected to the group and variation was discouraged, typified in the rigid strictures of the caste system, or status-based hierarchies elsewhere. The *tamasic* mode is useful for its stability and ordered production, but impinges on the development of the individual as the creative nodus of society, where each is dictated by her own unique inner law; instead, it holds them to conventions that place each in a customarily ordered hierarchy. This liberating tendency of the *rajasic* mode leads to a conflict of individuals, striving to emerge from pre-ordered hierarchies with each vying for a convenient distributive pattern. *Rajas* is not only enterprise and dynamism, but also power. The competitiveness and struggle that democratic and economic set ups are often bound up in, often through a right-based 'ordered conflict', is a characteristic feature of this *rajasic* temper, that works through competing desire-satisfaction and an as yet unenlightened and partial reason which seeks to universalize its particular orientations. For example, Sri Aurobindo notes:

The individualistic democratic ideal brings us at first in actual practice to the more and more precarious rule of a dominant class in the name of democracy over the ignorant, numerous and less fortunate mass. Secondly, since the ideal of freedom and equality is abroad and cannot any longer be stifled, it must lead to the increasing effort of the exploited masses to assert their down-trodden right and to turn, if they can, this pseudo democratic falsehood into the real democratic truth; therefore, to a war of classes. Thirdly, it develops inevitably as part of its process a perpetual strife of parties, at first few and simple in composition, but afterwards as at the present time an impotent and sterilising chaos of names, labels, programmes, war-cries. All lift the banner of conflicting ideas or ideals, but all are really fighting out under that flag a battle of conflicting interests. Finally, individualistic democratic freedom results fatally in an increasing stress of competition which replaces the ordered tyrannies of the infrarational periods of humanity by a sort of ordered conflict. And this conflict ends in the survival not of the spiritually, rationally or physically fittest, but of the most fortunate and vitally successful. It is evident enough that, whatever else it may be, this is not a rational order of society; it is not at all the perfection which the individualistic reason of man had contemplated as its ideal or set out to accomplish.⁹⁷

This is so until the *sattvik* modality, or the force of harmony, poise and freedom, emerges in our evolution, leading finally to the urge of transcendence in later stages. This *sattvik*, and spiritual, principle carries the power to purify and integrate our turbid and complex natures, culminating in a harmonious ordering of conflicting claims of individual freedom. Thus, Sri Aurobindo looks to collectivize the psycho-spiritual insight of the *sāṃkhya gunas*, justified by an appeal to empiricism and not belief, to render an incisive political psychology. In doing so, he reintroduces a teleological re-orientation of politics and arrives at the claim that our inner evolution dictates political structures, not visa-versa.

⁹⁷ Sri Aurobindo, CWSA, Vol. 25, 1997, 197.

ii. *Perfection of Democratic Systems in Philosophic or Spiritual Anarchism*

In this scheme of socio-political evolution, Sri Aurobindo identifies three successive stages of growth, each reflected in Auroville's current setup as we discuss in Parts III and IV: first in a democratic stage, in its individualistic and second, socialistic modes, and third, in the consummating ideal, a 'philosophic' or 'spiritual anarchism':

If we may judge from the modern movement, the progress of the reason as a social renovator and creator, if not interrupted in its course, would be destined to pass through three successive stages which are the very logic of its growth, the first individualistic and increasingly democratic with liberty for its principle, the second socialistic, in the end perhaps a governmental communism with equality and the State for its principle, the third — if that ever gets beyond the stage of theory — anarchistic in the higher sense of that much-abused word, either a loose voluntary cooperation or a free communalism with brotherhood or comradeship and not government for its principle. It is in the transition to its third and consummating stage, if or whenever that comes, that the power and sufficiency of the reason will be tested; it will then be seen whether the reason can really be the master of our nature, solve the problems of our interrelated and conflicting egoisms and bring about within itself a perfect principle of society or must give way to a higher guide. For till this third stage has its trial, it is Force that in the last resort really governs. Reason only gives to Force the plan of its action and a system to administer.⁹⁸

For Sri Aurobindo, the stress on individual liberty, as a reaction to the typical and conventional modes of organization, is proper and yet limited: either (i) in its tendency to create oligarchic minorities (that hold the majority in sway) and thus to recreate the infra-rational, status-based ordering of the conventional age in a disguised rationalism,⁹⁹ or (ii) in resulting in the 'tyranny of the majority' restricting minority rights, or (iii) in its excesses of competitive relationships, demonstrated at times in market arrangements. In each case, the collective impulse exerts a pressure to introduce a measure of equality. This too is proper yet limited: in its tendency to either unduly restrain liberty and expression, or create a cumbersome and ineffective organization centralized in a regulatory authority. This constant tussle between the freedom demanded by the individual ego and unity demanded by the corporate ego, subject to careful examination in his works, is central to the problem of collective organization in Auroville:

In the relations between the individual and the group, this constant tendency of Nature appears as the strife between two equally deep-rooted human tendencies, individualism and collectivism. On one side is the engrossing authority, perfection and development of the State, on the other the distinctive freedom, perfection and development of the individual man. The State idea, the small or the vast living machine, and the human idea, the more and more distinct and luminous Person, the

⁹⁸ Sri Aurobindo, CWSA, Vol. 25, 1997, 193.

⁹⁹ Sri Aurobindo, CWSA, 1997, Vol. 25, 210, bluntly captures this dynamic, a concern as we note later in relation to Working Groups in Auroville: 'Since that is so, government by the organised State must mean always government by a number of individuals, whether that number be in theory the minority or the majority makes in the end little fundamental difference. For even when it is the majority that nominally governs, in fact it is always the reason and will of a comparatively few effective men and not really any common reason and will of all that rules and regulates things with the consent of the half-hypnotised mass.'

increasing God, stand in perpetual opposition. The size of the State makes no difference to the essence of the struggle and need make none to its characteristic circumstances. It was the family, the tribe or the city, the polis; it became the clan, the caste and the class, the kula, the gens. It is now the nation. Tomorrow or the day after it may be all mankind. But even then the question will remain poised between man and humanity, between the self-liberating Person and the engrossing collectivity.¹⁰⁰

The democratic conception, whether in its individualist or communitarian forms, offers a marked development from the infra-rational or conventional stage. And yet, Sri Aurobindo notes, ‘the pity of ... this excellent theory’ is that it is ‘sure to stumble over a discrepancy between its set ideas and the actual facts of human nature,’ the ‘double soul’ of man discussed in Part I above, namely the surface desire-self and the deeper psychic-self.¹⁰¹

The expansive tendency of the desire-self – only partially enlightened by reason – brings us at first, by the mechanism of individualistic democratic forms, to a ‘more and more precarious rule of a dominant class in the name of democracy over the ignorant, numerous and less fortunate mass.’¹⁰² The universalism of reason ‘means in practice the fettering and misapplication of reason degraded into a servant of power to maintain the ruling class and justify the existing order’. This oligarchic tendency, he notes, is unsustainable ‘since the ideal of freedom and equality ... cannot any longer be stifled’; the ‘pseudo-democratic falsehood’, of representation and participation in name but not in substance, must translate into ‘the real democratic truth’, not likely by voluntary abdication of power by the conventional elite, but by a ‘war of classes.’ This ‘war’ of assertion, contained often within a rights-based framework, further

develops a perpetual strife of parties ... an increasing stress of competition which replaces the ordered tyrannies of the infra-rational periods of humanity by a sort of ordered conflict.¹⁰³

Thus, the idea of equal liberty of all, or democratic idealism, falls short, resulting often in the rule of an oligarchical minority or a competitive conflict. This, in Sri Aurobindo’s view, is because the ‘defect from which all this imperfection springs’ is man’s double nature – a constant tussle between the ‘animal nature of the vital and physical being’ and the higher nature of his spiritual being, mediated by the half-enlightening voice of his reason.¹⁰⁴ As we discuss in Part III, each of these are useful cautions for Auroville’s governance.

This tension leads to the birth of a third idea, that of anarchism: a free and spontaneous brotherhood, allowing each the space to pursue her equal liberty and creative expression in a harmonious whole without external imposition, either through a governmental system or otherwise. Here, the individual soul and the ‘group-soul’ – Sri Aurobindo’s distinct addition to the intellectual landscape, which we discuss below – mingle freely in an ‘ideal law of social development’:

¹⁰⁰ Sri Aurobindo, CWSA, Vol. 25, 1997, 291.

¹⁰¹ Sri Aurobindo, CWSA, Vol. 25, 1997, 209.

¹⁰² Sri Aurobindo, CWSA, Vol. 25, 1997, 197-8.

¹⁰³ Sri Aurobindo, CWSA, Vol. 25, 1997, 197-8.

¹⁰⁴ Sri Aurobindo, CWSA, Vol. 25, 1997, 234-5.

Freedom and harmony express the two necessary principles of variation and oneness, — freedom of the individual, the group, the race, coordinated harmony of the individual's forces and of the efforts of all individuals in the group, of all groups in the race, of all races in the kind, — and these are the two conditions of healthy progression and successful arrival. To realise them and to combine them has been the obscure or half-enlightened effort of mankind throughout its history, — a task difficult indeed and too imperfectly seen and too clumsily and mechanically pursued by the reason and desires to be satisfactorily achieved until man grows by self-knowledge and self-mastery to the possession of a spiritual and psychical unity with his fellow-men.¹⁰⁵

Mother's repeated emphasis on unity and fellow-feeling in the 'Dream' – particularly in resolving differences in the early years between architects as we discuss in Part III.A – strikes a similar chord:

In short, it would be a place where human relationships, which are normally based almost exclusively on competition and strife, would be replaced by relationships of emulation in doing well, of collaboration and real brotherhood.¹⁰⁶

This collective ordering – a realization of the ideals of liberty, equality, and fraternity – reflects the properties of the soul, the psychic being or *chaitya purusha*, the causal sheath, the higher term of evolution, currently cloaked by the mind, life, and body, the three lower terms of existence. Leaving details aside for the moment, Mother and Sri Aurobindo echo, in their own characteristic temper, an old idea that political institutions without a virtuous life cannot solve our collective problems.¹⁰⁷ To this, they add an important insight that a rational ordering or diffused humanism, though important and still lacking, is insufficient. A supra-rational spiritual progression is central to this task, as it 'goes to the root, and deals with the essential of conduct.'¹⁰⁸

Simply put, the ideals of liberty, equality and fraternity are not native properties of the rational, reflective man – they are a shadow aspiring to the greater light of our true nature, the spiritual self. They are *unrealizable* by a collective of rational selves, for the mind-body-life complex, the ego, is by its constitution a distorted rendering of the Truth, caught up in bondage and separateness, the socio-political result of the involutory 'self-revealing' of the Divine currently identified with the incomplete freedom of the 'fallen soul' – expressed through the lower terms of a mentalized bodily life – is incomplete, a 'barriered autarchy' that 'excluded light', 'flaunting its cross of servitude like a crown', clinging to its 'harsh autonomy'.¹⁰⁹ So long as models of collective organization operate on a rational ordering, discord and unfreedom

¹⁰⁵ Sri Aurobindo, CWSA, Vol. 25, 1997, 66. We discuss below the Sri Aurobindo's further specification of group-souls, which is relevant to the ideal of federated organization of the zones, particularly the International Zone.

¹⁰⁶ Guigan, 2018, Vol. 1, 51.

¹⁰⁷ The place of institutions and virtues in political life is subject to a longstanding debate. *See*, for example, Waldron, 2012.

¹⁰⁸ Swami Vivekananda, 2006-7, Vol. 5, 200. Sri Aurobindo, CWSA, 1997, Vol. 25, 236 ('The main failure, the root of the whole failure indeed, is that he has not been able to shift upward what we have called the implicit will central to his life, the force and assured faith inherent in its main power of action.')

¹⁰⁹ Sri Aurobindo, CWSA, Vols. 33-34, 1997, 216.

are unintentional but inevitable consequences: ‘The whole world yearns after freedom, yet each creature is in love with his chains: this is the first paradox and inextricable knot of our culture.’¹¹⁰

This is a radical, and not lightly accepted, critique and advance of a long and hoary post-Enlightenment tradition of rationalist political thinking, an area for rich comparative research in Auroville.¹¹¹ If a stable and just political order necessarily requires a collective suprarational realization, it is on one hand a stinging critique both of the limits of rationalization and faith-based orderings, and an epochal advance, if we use that term carefully, pointing the way to an as yet invisible future. Auroville’s collective yoga, of which governance is one practical manifestation, is then tied to testing the validity of this hypothesis – ‘in proportion as they succeed and to the degree to which they carry this evolution, the yet unrealized potentiality which they represent will become an actual possibility of the future.’¹¹²

iii. *The Play and Place of Reason*

The evolutionary step move from the rational to the suprarational is a defining move in Sri Aurobindo and Mother’s yoga, as indeed in many authentic spiritual pursuits. Collectively, this is reflected in the progressive move from the ‘age of reason and individualism’, with *rajaso-sattvik* democratic systems, to spiritual anarchism, an outer reflection of the collective transcendence of the *gunas*. This move, it bears emphasis, is not anti-rational, a rejection of the play of reason, but supra-rational, an illumination of it. Absent the foundation of ordered intellectual development, through the labour of an intricate rationalization of the collective, the enthusiasm of the supra-rational jump is likely to flounder. As we discuss in Parts III and IV, one expression of this rationalization is the professionalization of development works, with their characteristic insistence on its insistence on empirical, data-driven and means-end optimization. Put another way, an ordered rationalism may rise to illumination or regress into a vital subjectivism – this distinction between irrationalism and supra-rationalism is a key dynamic. This process demands a progressive, careful and methodical elevation of mentality, not an emotive rejection of it:

But there has as yet been no long intellectual preparation of a more and more dominant thought cast out by the intellectuals of the age to remould the ideas of common men, nor has there been any such gathering to a head of the growing revolt against present conditions as would make it possible for vast masses of men seized by the passion for an ideal and by the hope of a new happiness for mankind to break up the present basis of things and construct a new scheme of collective life.¹¹³

On this issue, we were met with several instances, both in our conversations and the records, of statements such as, ‘but that is too mental’, ‘we must reject the mind’ and so on. While naturally reason has to be transcended into the supra-rational, it is not to be rejected but

¹¹⁰ Mother, CWM, 2002, Vol. 9, 27.

¹¹¹ See, for a survey, Frazer, 2010.

¹¹² Sri Aurobindo, CWSA, 1997, Vol. 25, 261.

¹¹³ Sri Aurobindo, CWSA, 1997, Vol. 25, 385.

illuminated. Statements of this nature must be examined carefully, particularly if it serves as a rhetorical device, as seemed to be the case at times, to avoid entering the finer details of a problem.

It is reflected most centrally in the debate between organic and planned development, which we consider in Part II, that has resulted in long delays in the preparation of a Detailed Development Plan: organicity is not co-terminus with supra-rationalism, and may dangerously reflect an irrationalism that avoids the dictates of collective rationalization in an unsystematic and disordered development. Importantly, Sri Aurobindo does *not* reject the play of reason – rather, he locates it as a *necessary* instrument of *gradual* transcendence, enlargening perceptions and purifying error through the experiences of life to accommodate the conflicting demands of individualism and collectivism:

The reason cannot grasp all truth in its embrace because truth is too infinite for it; but still it does grasp the something of it which we immediately need, and its insufficiency does not detract from the value of its work, but is rather the measure of its value. For man is not intended to grasp the whole truth of his being at once, but to move towards it through a succession of experiences and a constant, though not by any means a perfectly continuous self enlargement. The first business of reason then is to justify and enlighten to him his various experiences and to give him faith and conviction in holding on to his self-enlargings. It justifies to him now this, now that, the experience of the moment, the receding light of the past, the half-seen vision of the future. Its inconstancy, its divisibility against itself, its power of sustaining opposite views are the whole secret of its value. It would not do indeed for it to support too conflicting views in the same individual, except at moments of awakening and transition, but in the collective body of men and in the successions of Time that is its whole business. For so man moves towards the infinity of the Truth by the experience of its variety; so his reason helps him to build, change, destroy what he has built and prepare a new construction, in a word, to progress, grow, enlarge himself in his self-knowledge and world-knowledge and their works. The second article of faith of the believer in reason is also an error and yet contains a truth. The reason cannot arrive at any final truth because it can neither get to the root of things nor embrace the totality of their secrets; it deals with the finite, the separate, the limited aggregate, and has no measure for the all and the infinite.¹¹⁴

In this movement, reason stands between the infra-rational and supra rational elements of our nature, the two primary motives of life: it disciplines the passions on one hand and aspires to that which exceeds it on the other. This intellectual step – reflected in an appropriate centralization of authority with a firm regulatory architecture, a professionalization of Working Groups and evidence-led, informed debates in the Residents' Assembly – is, in the context of Auroville, an important preparatory stage, without which attempts at philosophic or spiritual anarchism are dangerously premature.

This movement of collective reason demands its due. A premature rejection of intellectual ordering or ethical self-restraint, until it is replaced by something higher, risks a dangerous intermediate stage that may regress *back* to vitalism, rather than progress *forward* to the spirit.

¹¹⁴ Sri Aurobindo, CWSA, 1997, Vol. 25, 122.

In Goethe's words, 'everything that liberates our mind without at the same time imparting self-control is pernicious.'¹¹⁵ Sri Aurobindo articulates this point in his discussion on the necessity of social compulsion absent self-regulation:

For in their first crudeness the infrarational instincts do not correct themselves quite voluntarily without the pressure of need and compulsion, but only by the erection of a law other than their own which teaches them finally to erect a yet greater law within for their own correction and purification. The principle of social compulsion may not have been always or perhaps ever used quite wisely, — it is a law of man's imperfection, imperfect in itself, and must always be imperfect in its method and result: but in the earlier stages of his evolution it was clearly inevitable, and until man has grown out of the causes of its necessity, he cannot be really ready for the anarchistic principle of living.¹¹⁶

This is an all-important caution whilst designing governance systems for Auroville: the point is not to reject rationally ordered regulatory systems, but to illumine them. An understandable spiritual romanticism cannot substitute this painstaking task to refine, purify, streamline, illumine mundane regulations for planning, approvals, procedurally strong decision-making processes, review and monitoring etc. A spiritual culture, in Sri Aurobindo's evolutionary phraseology, is not infra-rational – resuscitating lost, unencumbered passions or invoking belief by reviving past religious formations – but supra-rational or beyond reason. It aspires to higher truths that lie beyond the ken of our intellect, embodied in the mystic core of religion (across traditions), yet buried in religious forms of the past that cover the living, experiential truth with progressively distant dogma, belief systems and ceremony (the move from the 'symbolic' to the 'typal' and finally 'conventional' age).

Yet, this movement, even if carried to the acme of impartial and disinterested thinking of pure reason (a notable advance, still unrealized in the mass in Auroville) is destined to remain incomplete, for two reasons, which inspire the further push to supra-rationalism.

First, reason's tussle with the passions leads *either* to partiality of thought, serving as an instrument to justify vital desires, or at best, a temporary submission of life to reason, rather than a transformation ('all appearances to the contrary are always a *trompe l'oeil*'), or in an excessive disciplining of the vitality (a common criticism of rationalist strains of political thought), it leads to sterility.¹¹⁷ And second, its aspiration to the spiritual, whilst useful as philosophical preparation, is limited by its method of dialectical reasoning and can lead, by way of attempting to fix the infinite in its own logical terms, to a narrowing down or fragmentation of that which exceeds it:

Nor can reason found a perfect life for man or a perfect society. A purely rational human life would be a life baulked and deprived of its most powerful dynamic sources; it would be a substitution of the minister for the sovereign. A purely rational society could not come into being and, if it could be born, either could not live or would sterilise and petrify human existence. The root powers of human life, its intimate causes are below, irrational, and they are above, suprarational. But this is

¹¹⁵ Goethe, 1998, 504.

¹¹⁶ Sri Aurobindo, CWSA, 1997, Vol. 25, 217.

¹¹⁷ Sri Aurobindo, CWSA, 1997, Vol. 25, 237.

true that by constant enlargement, purification, openness the reason of man is bound to arrive at an intelligent sense even of that which is hidden from it, a power of passive, yet sympathetic reflection of the Light that surpasses it. Its limit is reached, its function is finished when it can say to man, 'There is a Soul, a Self, a God in the world and in man who works concealed and all is his self-concealing and gradual self-unfolding. His minister I have been, slowly to unseal your eyes, remove the thick integuments of your vision until there is only my own luminous veil between you and him. Remove that and make the soul of man one in fact and nature with this Divine; then you will know yourself, discover the highest and widest law of your being, become the possessors or at least the receivers and instruments of a higher will and knowledge than mine and lay hold at last on the true secret and the whole sense of a human and yet divine living.

...

The solution lies not in the reason, but in the soul of man, in its spiritual tendencies. It is a spiritual, an inner freedom that can alone create a perfect human order. It is a spiritual, a greater than the rational enlightenment that can alone illumine the vital nature of man and impose harmony on its self seekings, antagonisms and discords.¹¹⁸

For Sri Aurobindo, to 'overcome the egoism of individualistic life and bring about a perfect principle and rational order of society in a harmonious world,' requires a gradual shift 'upward' from rational ordering to a principle higher than reason (a supra-rational, spiritual faculty). Reason can and must helpfully purify the vitality through ethical discipline, but only the spirit can transform it:

Life must not be repressed, minimised and mechanised by the arbitrary control of reason. Life has greater powers in it which must be given a freer play; for it is they alone that evolve and create. On the other hand, it is felt that reason is too analytical, too arbitrary, that it falsifies life by its distinctions and set classifications and the fixed rules based upon them and that there is some profounder and larger power of knowledge, intuition or another, which is more deeply in the secrets of existence.¹¹⁹

The questioning 'disenchantment', to use Weber's famous phrase, of what Sri Aurobindo called the 'age of reason', is necessary to cast away that detritus, and prepare for a greater re-enchancement of our lives.¹²⁰ We arrive from false religion to the true spirit *through* reason, recovering the 'old', yet eternal, spiritual truth in new forms. It is this inner evolution of consciousness that grounds in its collective dimension, a free, equal and fraternal collectivity that is reflected in the transition from the age of individualism and reason – the collective *manomaya* – to that of the age of subjectivity – the collective *vijnanamaya* and *anandamaya*. This 'greater psychology' of yoga, collectivized in the *Human Cycle*, forms the social and political charter of Auroville.

iv. *The Dangerous Move from the Objective to Subjective*

In Sri Aurobindo's scheme, this move from the rational to the supra-rational is one from the objective, disembodied reason to the subjective spirit – effective governance begins to

¹¹⁸ Sri Aurobindo, CWSA, 1997, Vol. 25, 123, 220.

¹¹⁹ Sri Aurobindo, CWSA, 1997, Vol. 25, 123, 106.

¹²⁰ See, for an aligned account, Taylor, 1989, 2007.

substitute that which is without, rational constraints on individual behaviour for collective efficiency and order, to that which is within, a purification of the ego that allows for the expression of the self. In studying the growth of governance and institutional systems in Auroville, then, we may say that ‘behind the economic motives and causes of social and historical development’ of these institutions ‘are profound psychological, even perhaps soul factors’ – the outer reflects the inner.¹²¹

The ordered evolution of our moral sentiments, from animal instinct and egotistical behaviour to camaraderie and cooperation, born of a sense of the underlying unity of all in the Divine, is the ethical strain of Sri Aurobindo’s thought. As Radhakrishnan said, we are God and brute crossed, and some humanizing influence needs to anchor that evolution, without which institutional machineries are but Hobbesian restraints to maintain a simmering, patchwork peace.¹²² In considering this question – of what are effective forms of governance to realize the trinity of liberty, equality and fraternity –, Sri Aurobindo marks a transition from the ‘objective view of life’ – that looks to a mechanical process ‘of management, of ordering, perfection’ of the collective, a kind of disengaged prescription of rules from without for coordinated collective behaviour – to the ‘subjective view of life’ – that looks to the developing self-consciousness from within, an embodied vitality aspiring to the self.¹²³ As Taylor examines in his incisive study of how rationalist strains entrenched in modernity subtly push us to a ‘disenchanted’ conception of our selves as transient embodied beings, this inward turn goes ‘against the grain of much modern thought and culture.’¹²⁴ Sri Aurobindo paints the contrast between the two, worth quoting on at length as it encapsulates a crucial tipping point where Auroville lies:

The principle of subjectivism entering into human thought and action, while necessarily it must make a great difference in the view-point, the motive-power and the character of our living, does not at first appear to make any difference in its factors. Subjectivism and objectivism start from the same data, the individual and the collectivity, the complex nature of each with its various powers of the mind, life and body and the search for the law of their self-fulfilment and harmony. But objectivism proceeding by the analytical reason takes an external and mechanical view. of the whole problem. It looks at the world as a thing, an object, a process to be studied by an observing reason which places itself abstractly outside the elements and the sum of what it has to consider and observes it thus from outside as one would an intricate mechanism. The laws of this process are considered as so many mechanical rules or settled forces acting upon the individual or the group which, when they have been observed and distinguished by the reason, have by one’s will or by some will to be organised and applied fully much as Science applies the laws it discovers. These laws or rules have to be imposed on the individual by his own abstract reason and will isolated as a ruling authority from his other parts or by the reason and will of other individuals or of the group, and they have to be imposed on the group itself either by its own collective reason and will embodied in some machinery of control which the

¹²¹ Sri Aurobindo, CWSA, 1997, Vol. 25, 123, 25.

¹²² Radhakrishnan, 1913, 169; Sri Aurobindo, CWSA, 1997, Vol. 25, 50-65.

¹²³ Sri Aurobindo, CWSA, 1997, Vol. 25, 58.

¹²⁴ Taylor, 1985, Vol. 2, 168-170.

mind considers as something apart from the life of the group or by the reason and will of some other group external to it or of which it is in some way a part.

Subjectivism proceeds from within and regards everything from the point of view of a containing and developing self consciousness. The law here is within ourselves; life is a self creating process, a growth and development at first subconscious, then half-conscious and at last more and more fully conscious of that which we are potentially and hold within ourselves; the principle of its progress is an increasing self-recognition, self-realisation and a resultant self-shaping. Reason and will are only effective movements of the self, reason a process in self-recognition, will a force for self-affirmation and self shaping. Moreover, reason and intellectual will are only a part of the means by which we recognise and realise ourselves. Subjectivism tends to take a large and complex view of our nature and being and to recognise many powers of knowledge, many forces of effectuation.¹²⁵

This passage requires a far more sustained reflection than we can provide here. But three points can be made. First, this shift is epistemic – it concerns the orientation of our approach, a subtle and often ineffable shift within to recognize the potentialities that elude the intellect. In this, as Sri Aurobindo considers elsewhere in some detail, it can be destabilizing: the complexity of the inner worlds, subject to subtler and dynamic laws, places us in a long, intermediate and dangerous stage of non-rationalism, yet not of the self. The utility of rational ordering is not denied, yet the limits, of the ‘arbitrariness’ of our ‘abstract reason and will’, a kind of disembodied dictation of rules from without, is pointed to, as a call to silence and illumine the mind, not reject it. The careful purification of these intermediate worlds to the spiritual essence demands access to the greater yet hidden law of the being, beyond conceptual constructions. Second, it can be destabilizing. As Sri Aurobindo notes elsewhere, the replacement of the mental with the spiritual risks giving free play to the vital, a false subjectivism. A perfection of reason is necessary to attempt this shift, ‘a necessary passage to the subjective period of humanity.’¹²⁶ The appeal to the subjective – vitally, as the Will-to-be or mentally, as intuition – is an illumination of the mind and vital, to initiate and act ‘from the centre’, the psychic being, the self, not an emotive, passionate centre:

Even, we see it in its first movement away from the external and objective method discount and belittle the importance of the work of the reason and assert the supremacy of the life-impulse or the essential Will-to-be in opposition to the claims of the intellect [a movement that can, as we have noted, turn into a dangerous anti-intellectual stance if unchecked] or else affirm some deeper power of knowledge, called nowadays the intuition, which sees things in the whole, in their truth, in their profundities and harmonies while intellectual reason breaks up, falsifies, affirms superficial appearances and harmonises only by a mechanical adjustment. But substantially we can see that what is meant by this intuition is the self-consciousness feeling, perceiving, grasping in its substance and aspects rather than analysing in its mechanism its own truth and nature and powers. The whole impulse of subjectivism

¹²⁵ Sri Aurobindo, CWSA, 1997, Vol. 25, 59.

¹²⁶ Sri Aurobindo, CWSA, 1997, Vol. 25, 14.

is to get at the self, to live in the self, to see by the self, to live out the truth of the self internally and externally, but always from an internal initiation and centre.¹²⁷

Third, it is profoundly difficult: ‘for it means that no machinery invented by the reason can perfect either the individual or the collective man; an inner change is needed in human nature, a change too difficult to be ever affected except by the few.’¹²⁸ In this, if it can be achieved, it carries the power to recast collective, discovering a vital brotherhood, not an intellectually ordered patchwork association, with significant governance consequences to ground the ‘ideal law of social development’. At any rate, the call is made to journey the inner worlds, felt vaguely when the veil is briefly rent – ‘if this is not the way, then there is no way ...’¹²⁹

Indeed, it is worth noting that Sri Aurobindo was writing not in the abstract, his hefty philosophical vocabulary aside, but as a response to a marked sociological phenomenon: the widespread sense of alienation from value and meaning in modern society, the loss of the intimate inner to the disengaged reason, one of the ‘malaises of modernity’.¹³⁰ This had a particular resonance in Auroville’s founding movement – the search for the ‘Great Sense’, inarticulate yet compelling, an aporetic reaction to wanting something more.¹³¹ It is this impulse, this search for ‘self-recognition, self-affirmation and self-shaping’, to give free play to the larger forces of life ‘managed’ by the machinery of the mind, that drove the creativity, experimentation and enterprise manifest at the times.

Initiating and acting from the ‘centre’, or aspiring to it, is the key to Mother’s Charter, the ‘first discovery’ she asks Aurovilians to make. In this difficult transition within and upward to the centre lies the nub of the debate on governance in Auroville:

So the State is viewed in modern political thought as an entity in itself, as if it were something apart from the community and its individuals, something which has the right to impose itself on them and control them in the fulfilment of some idea of right, good or interest which is inflicted on them by a restraining and fashioning power rather than developed in them and by them as a thing towards which their self and nature are impelled to grow. Life is to be managed, harmonised, perfected by an adjustment, a manipulation, a machinery through which it is passed and by which it is shaped. A law outside oneself, — outside even when it is discovered or determined by the individual reason and accepted or enforced by the individual will, — this is the governing idea of objectivism; a mechanical process of management, ordering, perfection, this is its conception of practice.¹³²

As we discuss in Part IV, the practical challenge of governance in Auroville lies in designing institutional forms that can progressively substitute restraining and fashioning rules – prescribing forms of conduct for residents – with regulatory frames that can acculture behaviour through appropriate incentives, guides for an inner evolution. This move is neither

¹²⁷ Sri Aurobindo, CWSA, 1997, Vol. 25, 59.

¹²⁸ Sri Aurobindo, CWSA, 1997, Vol. 25, 220.

¹²⁹ Sri Aurobindo, CWSA, 1997, Vol. 25, 220.

¹³⁰ Taylor, 1998.

¹³¹ Satprem, 1969.

¹³² Sri Aurobindo, CWSA, 1997, Vol. 25, 58.

linear nor antagonistic, as several conversants considered, but part of a natural evolution that must be carefully handled with a pragmatic and context-dependent use of soft and hard regulatory modes. The practical manifestation of governance forms in Auroville that facilitate this subjective turn is neither easy nor clear (notably, Sri Aurobindo does not prescribe clear institutional forms to accommodate it). As we discuss below, it is often laced with problems of an unchecked vitalism disguised as the true inward movement. Yet, this subjective move forms a fertile, if unstable, ground for experimentation, a journey into the ‘inner countries’.¹³³

In an important passage that encapsulates conversations during our research, Sri Aurobindo references various forms of collective organization that define the political adventurism of the *rajasic-sattwic* mentality. This mentality, exhibited in fair measure in Auroville’s public discourse, on its meandering journey to the subjective is a fertile space for equally valid, and often interminable, arguments for and against. They are driven (i) either as rational justifications for a vitally desired organization that happen to benefit our current position in the collective or (ii) a gymnastic play of pure reason – leading to a growing subjectivism that reconciles the partial truths of each through a gradual spiritual *practice* that translates intellectual comprehension and faith into ‘knowledge by identity’, through *experience*.¹³⁴ This lengthy passage is worth quoting at length:

The truth is that upon which we are now insisting, that reason is in its nature an imperfect light with a large but still restricted mission and that once it applies itself to life and action it becomes subject to what it studies and the servant and counsellor of the forces in whose obscure and ill-understood struggle it intervenes. It can in its nature be used and has always been used to justify any idea, theory of life, system of society or government, ideal of individual or collective action to which the will of man attaches itself for the moment or through the centuries. In philosophy it gives equally good reasons for monism and pluralism or for any halting-place between them, for the belief in Being or for the belief in Becoming, for optimism and pessimism, for activism and quietism. It can justify the most mystic religionism and the most positive atheism, get rid of God or see nothing else. In aesthetics it supplies the basis equally for classicism and romanticism, for an idealistic, religious or mystic theory of art or for the most earthy realism. It can with equal power base austere a strict and narrow moralism or prove triumphantly the thesis of the antinomian. It has been the sufficient and convincing prophet of every kind of autocracy or oligarchy and of every species of democracy; it supplies excellent and satisfying reasons for competitive individualism and equally excellent and satisfying reasons for communism or against communism and for State socialism or for one variety of socialism against another. It can place itself with equal effectivity at the service of utilitarianism, economism, hedonism, aestheticism, sensualism, ethicism, idealism or any other essential need or activity of man and build around it a philosophy, a political and social system, a theory of conduct and life. Ask it not to lean to one idea alone, but to make an eclectic combination or a synthetic harmony and it will satisfy you; only, there being any number of possible combinations or harmonies, it will equally well justify the one or the other and set up or throw down any one of them according as the spirit in man is attracted to or withdraws from it. For it is really that which

¹³³ Sri Aurobindo, CWSA, 1997, Vols. 33-4, 488.

¹³⁴ This move from indirect, ‘separative’ knowledge to ‘knowledge by identity’ is important to stress. This requires a detailed discussion, beyond our scope. *see*, Sri Aurobindo, CWSA, 1997, Vols. 21-2, 543-572.

decides and the reason is only a brilliant servant and minister of this veiled and secret sovereign. This truth is hidden from the rationalist because he is supported by two constant articles of faith, first that his own reason is right and the reason of others who differ from him is wrong, and secondly that whatever may be the present deficiencies of the human intellect, the collective human reason will eventually arrive at purity and be able to found human thought and life securely on a clear rational basis entirely satisfying to the intelligence.¹³⁵

As we discuss in Parts III and IV, this meta-dynamic is exhibited abundantly in Auroville – with a veritable catalogue of plans, proposals and schemes, at times for participatory processes, elsewhere for centralization, at times for stronger regulation of productive life, elsewhere for light oversight, at times for dynamism and growth, elsewhere for a slow and patient march, at times for urbanization, elsewhere for the ecological imperative, at times for planned, systematic development, elsewhere for organic growth, at times for a vague mysticism, elsewhere for a level-headed realism, at times for stronger ethical controls, elsewhere for free play and experimentation, at times for technocratic planning, elsewhere for collective processes, at times for egalitarian distribution of basic necessities, elsewhere for liberty and diversity to self-organize, at times for sale of outlying lands, elsewhere for their protection, at times for phased certification, elsewhere for none, at times for an architectural idealism, elsewhere for a pragmatic vision, and so on. In these debates, many of an old vintage, come passionate appeals, often considering the other as mutually incompatible, with the hope, at times against hope, that some collective intelligence will emerge in time to arrive at a consensus.

In that process, the see-saw, each often motivated by the partiality of desire, to which the mind lends its argumentative powers as servant, not master, comes an impasse and exhaustion without a pathway for cohesive action, palpable in many quarters. Slowly, perhaps too slowly, the ‘accumulating stock of self-experience’ leads Auroville forward:

His politics and society are a series of adventures and experiments among various possibilities of autocracy, monarchism, military aristocracy, mercantile oligarchy, open or veiled plutocracy, pseudo-democracy of various kinds, bourgeois or proletarian, individualistic or collectivist or bureaucratic, socialism awaiting him, anarchism looming beyond it; and all these correspond to some truth of his social being, some need of his complex social nature, some instinct or force in it which demands that form for its effectuation. Mankind works out these difficulties under the stress of the spirit within it by throwing out a constant variation of types, types of character and temperament, types of practical activity, aesthetic creation, polity, society, ethical order, intellectual system, which vary from the pure to the mixed, from the simple harmony to the complex; each and all of these are so many experiments of individual and collective self-formation in the light of a progressive and increasing knowledge. That knowledge is governed by a number of conflicting ideas and ideals around which these experiments group themselves: each of them is gradually pushed as far as possible in its purity and again mixed and combined as much as possible with others so that there may be a more complex form and an enriched action. Each type has to be broken in turn to yield place to new types and each combination has to

¹³⁵ Sri Aurobindo, CWSA, 1997, Vol. 25, 121.

give way to the possibility of a new combination. Through it all there is growing an accumulating stock of self-experience and self-actualisation of which the ordinary man accepts some current formulation conventionally as if it were an absolute law and truth, — often enough he even thinks it to be that, — but which the more developed human being seeks always either to break or to enlarge and make more profound or subtle in order to increase or make room for an increase of human capacity, perfectibility, happiness. This view of human life and of the process of our development, to which subjectivism readily leads us, gives us a truer vision of the place of the intellect in the human movement.¹³⁶

The supra-rational evolution of man, the move from the objective to the subjective view of life, perhaps distant, yet unrealized and utopian, is the keynote to purify the passions and illumine the mind beyond these contraries in a unified, not uniform, whole: a ‘real brotherhood’. The path to that unity not linear, but a complex and accretive play, emphasizing in turn various elements as it builds a whole:

Nature starts with this distortion and plays with all the combinations to which it can lead before she will allow it to be righted. Afterwards, she gathers up all the essence of these combinations into a new and rich harmony of love and freedom.¹³⁷

For Sri Aurobindo, the inner instrumentality of the psychic being can alone accomplish this outer architecture, and therefore, the search for subjective meaning, an inward orientation, is a necessary step in our collective evolution to ground an ideal model of governance. To expand the institutional repertoire – necessary to organize and govern the Auroville collective – from the well-rehearsed dynamics of individualism and collectivism, centralization and decentralization depends on the strength and purity of this collective aspiration. Institutional mechanism can help, and as we discuss in Part IV, are much-needed, yet, in the final analysis, the inner determines the outer: a change in our *nature* is necessary. This is Sri Aurobindo and Mother’s pointed and central addition to political thinking, marrying the supra-rational push of Vedanta to problems of collective organization, not only individual salvation.¹³⁸ As we discuss in Parts III and IV, this intervening movement of reason from the vital to the spiritual, pleading the case for individualism and collectivism with equal force, is a necessary passage in the *practical* arrangement of governance systems in Auroville. It cannot be leapfrogged, as many interviews during our research seemed to suggest. So understood, Mother’s ‘Dream’ for Auroville is placed at this intersection:

... a place of peace, concord and harmony where all the fighting instincts of man would be used exclusively to conquer the causes of his sufferings and miseries, to surmount his weaknesses and ignorance, to triumph over his limitations and incapacities; a place where the needs of the spirit and the concern for progress would take precedence over the satisfaction of desires and passions, the search for pleasure and material enjoyment.¹³⁹

¹³⁶ Sri Aurobindo, CWSA, 1997, Vol. 25, 118.

¹³⁷ Sri Aurobindo, CWSA, 1997, Vol. 13, 206.

¹³⁸ This is a key area for comparative research. *See*, for a review of this question – the relevance of natural traits of co-operation, violence, hierarchy, dominance etc. as applied to political thinking, Salter, 1996.

¹³⁹ Guigan, 2018, Vol. 1, 50.

v. *Hidden Telos of the Political Līlā*

In the spiritual scheme of things, the defence of freedom, equality and liberty here is grounded in the evolutionary impulse, the hidden *telos* in the Vedantic scheme, to recover the involved Divinity, here applied to political arrangements. The long, meandering and often violent pulls and pushes of individual and class assertion to satisfy the mutually conflicting demands for equality and liberty, the stuff of our collective life (in Auroville as elsewhere), are then a political *līlā*. One that is destined for playful, if painful, consummation. Ontologically grounded as such, these demands are a native property and function of the truth of our beings, of the Many seeking the One and the One manifesting in the Many. This is symbolized beautifully in the Upanishadic image of the inverted *ashwattha* tree, what Sri Aurobindo describes as ‘a skyward being nourishing its roots’.¹⁴⁰ It is this complex play of unity in diversity – ‘each thing in its place and there would be a place for everything’ – that is to be made a living practice in Auroville:¹⁴¹

In deepest reality the infinitely One is also infinitely multiple; we are not only a reflection or portion of That but we are That; our spiritual individuality — unlike our ego — does not preclude our universality and transcendence. But at present the soul or self in us intent on individualisation in Nature allows itself to be confused with the idea of the ego; it has to get rid of this ignorance, it has to know itself as a reflection or portion or being of the supreme and universal Self and solely a centre of its consciousness in the world-action.¹⁴²

When the soul claims freedom, it is the freedom of its self-development, the self-development of the divine in man in all his being. When it claims equality, what it is claiming is that freedom equally for all and the recognition of the same soul, the same godhead in all human beings. When it strives for brotherhood, it is founding that equal freedom of self-development on a common aim, a common life, a unity of mind and feeling founded upon the recognition of this inner spiritual unity. These three things are in fact the nature of the soul; for freedom, equality, unity are the eternal attributes of the Spirit. It is the practical recognition of this truth, it is the awakening of the soul in man and the attempt to get him to live from his soul and not from his ego which is the inner meaning of religion, and it is that to which the religion of humanity also must arrive before it can full itself in the life of the race.¹⁴³

One may thus trace the evolution of the political process along this map, with Sri Aurobindo. The ‘age of reason’ deconstructs, by way of the claim of individual liberty and right, the cramping effects of convention (religious and otherwise), to free the individual in his *necessarily* subjective search for the truth of his being. Briefly, this deconstruction leads to a period of predominantly critical and materialistic, or naturalistic, worldviews, as a response to the excesses of religious dogma absent their spiritual kernel. It rejects authority and demands *empirical proof* of religious and customary propositions; in finding them wanting, it proceeds

¹⁴⁰ Sri Aurobindo, CWSA, 1997, Vols. 33-34, 22.

¹⁴¹ Guigan, 2018, Vol. 2, 274.

¹⁴² Sri Aurobindo, CWSA, 1997, Vols. 23-4, 215-6.

¹⁴³ Sri Aurobindo, CWSA, 1997, Vol. 25, 570.

to its own investigations and discoveries, a perilous (because unchastened) yet needed stage for a nascent subjectivity:

It is this principle and necessity that justify an age of individualism and rationalism and make it, however short it may be, an inevitable period in the cycle. A temporary reign of the critical reason largely destructive in its action is an imperative need for human progress. In India, since the great Buddhistic upheaval of the national thought and life, there has been a series of recurrent attempts to rediscover the truth of the soul and life and get behind the veil of stifling conventions; but these have been conducted by a wide and tolerant spiritual reason, a plastic soul intuition and deep subjective seeking, insufficiently militant and destructive. Although productive of great internal and considerable external changes, they have never succeeded in getting rid of the predominant conventional order. The work of a dissolvent and destructive intellectual criticism, though not entirely absent from some of these movements, has never gone far enough; the constructive force, insufficiently aided by the destructive, has not been able to make a wide and free space for its new formation. It is only with the period of European influence and impact that circumstances and tendencies powerful enough to enforce the beginnings of a new age of radical and effective revaluation of ideas and things have come into existence. The characteristic power of these influences has been throughout — or at any rate till quite recently — rationalistic, utilitarian and individualistic. It has compelled the national mind to view everything from a new, searching and critical standpoint, and even those who seek to preserve the present or restore the past are obliged unconsciously or half-consciously to justify their endeavour from the novel point of view and by its appropriate standards of reasoning. Throughout the East, the subjective Asiatic mind is being driven to adapt itself to the need for changed values of life and thought. It has been forced to turn upon itself both by the pressure of Western knowledge and by the compulsion of a quite changed life-need and life-environment. What it did not do from within, has come on it as a necessity from without and this externality has carried with it an immense advantage as well as great dangers.¹⁴⁴

This movement is key – it places the heady and important currents of collective rationality, often at odds with the spiritual enterprise in the disenchantment of our age, as a necessary step on the advance to the supra-rational, securing the foundations for a modern spirituality. As we discuss in Part IV, it is not an abandonment of the rational faculty, but its progressive illumination, that is the defining movement for Auroville to develop its regulatory and governance architecture. This is so particularly in the social and technological context of Auroville, as a cosmopolitan meeting of these apparently contrary tendencies, a ‘bridge between the past and the future’: a modern, technologically and productively robust and spiritual enterprise, one that can marry the old antagonisms.

This advance of reason, aided by the prodigious outputs of science in the last two centuries, yielded not only technological discoveries in the physical, but also, attempted to mould the ethical, mental and spiritual in that image.¹⁴⁵ It attempted to recreate a scientifically ordered society, backed by a secular humanism with no need of scriptural authority, that can achieve in

¹⁴⁴ Sri Aurobindo, CWSA, 1997, Vol. 25, 26.

¹⁴⁵ Sri Aurobindo, CWSA, 1997, Vol. 25, 192-207; Taylor, 1989; Taylor, 1998; Sen, 2004. This is a fertile rea for comparative research in Auroville.

its ideal in an arithmetic blend of equality and liberty – a valid, if ultimately ill-fated, attempt to perfect the ‘objective view of life.’ In this movement, the unified religious *communitas*, with its internal hierarchies and status roles, gives way to a diverse ‘secular’ community, with plural and heterodox, if at times peculiar, forms of seeking that reject external (theocratic, political or social) authority, yet without a stable base of their own.¹⁴⁶ A search for inward-authenticity drives a confused, fertile and individualist culture, with economic and productivity gains often casting a deep imprint on moral outlooks.¹⁴⁷

Interestingly, Sri Aurobindo notes that the urge for an anarchist arrangement may arise as a revolt against the cramping bonds of a rational and economic ordering, beneficial for its efficient material arrangement yet sterilizing the vital founts of life that demand variation, free development and above all, *adventure* and *space*:

Thus we should have a new typical order based upon purely economic capacity and function, ... and rapidly petrifying by the inhibition of individual liberty into a system of rationalistic conventions. And quite certainly this static order would at long last be broken by a new individualist age of revolt, led probably by the principles of an extreme philosophical Anarchism.¹⁴⁸

This was a dominant motivation for the ‘pioneers’ in the early years of Auroville, driven by the growing dissatisfaction of youth-led counter-culture movements of the 1970s.¹⁴⁹ This seems to have left an imprint on Auroville’s present: we were met in interviews with a marked, though at times generic and unsubstantiated, aversion to ‘rationalistic conventions’ (rules for ordered management, efficient organization and resource allocation, monitoring and review practices etc.) in city building and socio-economic planning exercises, which are often perceived as ‘going back to the old order’. Sri Aurobindo’s description resonates with these oft-expressed sentiments, yet as we note below with a caution to replace this rejection with a positive vision still not articulated in the Auroville collective:

Men may bear it for a time in consideration of the great and visible new benefits of order, economic development, means of efficiency and the scientific satisfaction of the reason which the collectivist arrangement of society will bring; but when its benefits become a matter of course and its defects become more and more realised and prominent, dissatisfaction and revolt are sure to set in in the clearest and most vigorous minds of the society and propagate themselves throughout the mass. This

¹⁴⁶ This view – as also others reflections in this part generally – is too broad to be accurate, yet constraints limit a deeper discussion. *See*, for a meta-historical account of this shift, Taylor, 2007, a detailed work in social theory which interacts, and in many cases, dovetails, with Sri Aurobindo’s analysis in the *Human Cycle*.

¹⁴⁷ *See*, for example, Rosthchild, 2001, 155, *passim*; Sen, 2002.

¹⁴⁸ Sri Aurobindo, CWSA, 1997, Vol. 25, 22. The phenomenon of ‘over-rationalized’ economic technocracy has been incisively criticized – it dries up political participation and solidarity, and risks in modern systems to a self-defeating enslavement to the engines of commodified production in goods as well as mindsets. The pursuit of that which is to liberate us, reason, itself becomes irrational, a source of unfreedom. For a complex, and contested, analysis of this paradoxical movement, *see*, Adorno and Horkheimer, 2002; *see also*, for an examination of ‘means-end instrumentality’ in modern social systems that hinders the inward turn, Taylor, 1998, and for a discussion on the bureaucratic challenge to participatory self-rule, his *Philosophical Arguments*, 1985, Vol. 2, 143-144. Taylor’s analysis shares much in common with Sri Aurobindo’s, and reflects many strands of criticism that came up in conversations during our research of life elsewhere that motivated Aurovilians to migrate. In this, comparative work on Taylor’s corpus can be explored for comparative research in Auroville.

¹⁴⁹ *See*, for example, Ciconesi and Ciconesi, 2012; Majumdar, 2017; Devin, 2009.

intellectual and vital dissatisfaction may very well take under such circumstances the form of anarchistic thought, because that thought appeals precisely to this need of free variation in the internal life and its outward expression which will be the source of revolt, and anarchistic thought must be necessarily subversive of the socialistic order ... This tendency to mechanisation is the inherent defect of the State idea and its practice. Already that is the defect upon which both intellectual anarchistic thought and the insight of the spiritual thinker have begun to lay stress, and it must immensely increase as the State idea rounds itself into a greater completeness in practice. It is indeed the inherent defect of reason when it turns to govern life and labours by quelling its natural tendencies to put it into some kind of rational order.

It is in this context that Sri Aurobindo's discussion on spiritual anarchism, and Mother's reference to the Divine anarchy, can be understood. We consider the implications of this outline on Auroville's governance practices today in Part IV, particularly in relation to the resistant centralization of authority and an insufficient rationalization of Working Groups, which form the foundation for a mature attempt at anarchism. As is the case today in Auroville, the drive to anarchism arises as a synthesis of the individualistic and socialistic conceptions, each pulling in its own direction:

Anarchistic thought, although it has not yet found any sure form, cannot but develop in proportion as the pressure of society on the individual increases, since there is something in that pressure which unduly oppresses a necessary element of human perfection. We need not attach much importance to the grosser vitalistic or violent anarchism which seeks forcibly to react against the social principle or claims the right of man to 'live his own life' in the egoistic or crudely vitalistic sense. But there is a higher, an intellectual anarchistic thought which in its aim and formula recovers and carries to its furthest logical conclusions a very real truth of nature and of the divine in man. In its revolt against the opposite exaggeration of the social principle, we find it declaring that all government of man by man by the power of compulsion is an evil, a violation, a suppression or deformation of a natural principle of good which would otherwise grow and prevail for the perfection of the human race. Even the social principle in itself is questioned and held liable for a sort of fall in man from a natural to an unnatural and artificial principle of living.¹⁵⁰

In Sri Aurobindo's meta-historical narrative, this undoubted, necessary and inevitable advance over the 'conventional age' yet has its limitations, the 'limits of reason' in the *Human Cycle* as a faculty of knowing and being, unable to reconcile these contraries ('vaguely it is felt that there is some greater godhead than the reason').¹⁵¹ Accordingly, in the political Vedantic scheme of Sri Aurobindo and Mother, a defence of liberty and equality calls for the true spiritual foundation of these principles, to which our reason in its evolution is aspiring and must one day experience as its highest culmination and origin.

vi. *Mistaking Vital for Philosophic or Spiritual Anarchism*

Sri Aurobindo makes an important distinction in the passages quoted above between vital anarchism / unchecked, gross vital subjectivism and intellectual or spiritual anarchism. The former is a reactionary force against the demands of unity, looking to create space for one to

¹⁵⁰ Sri Aurobindo, CWSA, 1997, Vol. 25, 216.

¹⁵¹ Sri Aurobindo, CWSA, 1997, Vol. 25, 105.

‘live his own life,’ while the latter is a harmonizing force that reconciles the opposites. Three points can be made here:

First, the common rejection of ‘rationalistic conventions’ in interviews during our research risks conflating this all-important distinction, with irrationalism disguised as an appeal to supra-rationalism – this is reflected, for example, in conflating organicity with disorder borne of vital subjectivism, as opposed to a progressive and ordered illumination of planning and regulatory codes, such as the 2001 Perspective Masterplan and raft of proposals since. We discuss the practical implications of this distinction in our overview of urban infrastructure development in Part III.A, and in terms of the construction of rationally ordered authority in Part IV.

Second, as we discuss below, Auroville’s urban challenge – for a rich, dynamic and cohesive city fabric – places this distinction in sharp relief: it exerts pressure on vital anarchism, which manifests currently in the loosely organized urban sprawl, by pushing for a closely knit field for social relations where space and resources are scarce. This is all the better, as the inward turn demanded by ‘philosophical anarchism’ is to be put to the test in a critical density. This may naturally create friction between individuals, but it is in that process of interchange, going from tolerance to camaraderie, that unity is to be developed. Sri Aurobindo makes this point explicit:

Man does not actually live as an isolated being, nor can he grow by an isolated freedom. He grows by his relations with others and his freedom must exercise itself in a progressive self-harmonising with the freedom of his fellow-beings. The social principle therefore, apart from the forms it has taken, would be perfectly justified, if by nothing else, then by the need of society as a field of relations which afford to the individual his occasion for growing towards a greater perfection.

...

Afterwards, when again the individual asserts his freedom, as some day he must, he may have learned to do it on the basis of this unity and not on the basis of his separate egoistic life. This may well be the intention of Nature in human society in its movement towards a collectivist principle of social living.¹⁵²

This competing play was key in Anger’s early planning imagination:

We feel that an important number of contacts between individuals is so necessary for a balanced community existence that, with the help of modern technology, we conceived an architecture which aims at inducing this cohesion, this warm mutuality. In short, we start with artificial platforms, terraces on which we have positioned a highly concentrated habitat ... Redensification is today's necessity.¹⁵³

Third, in this reconciliation of competing liberties vying for space (particularly when unchecked by an architecture of rules as historically has been the case in Auroville), both Sri Aurobindo and Mother forefront the importance of fraternity or brotherhood, ‘the third and most neglected term of the famous formula.’ To avoid a system of ‘competitive liberty’ or ‘an

¹⁵² Sri Aurobindo, CWSA, 1997, Vol. 25, 216, 215.

¹⁵³ Anger, ‘=1’, 1968.

ordered conflict of rights’, on one hand, and an unhelpful levelling down in the name of equality or participation, on the other (dynamics observed in Auroville, as we discuss in Part III), Sri Aurobindo notes that the collective pyramid must be based on a well-established fraternity born of fellow-feeling. His nuanced reconciliation of the conflicting demands of liberty and equality offers a new voice in a long and intractable debate on the issue in political thinking,¹⁵⁴ again with which comparative research in Auroville is an important research area. For him, echoing earlier thinkers, an ideal collective requires members with cultured, reflective instinct for other-regarding behaviour.¹⁵⁵ This could be a calculated reciprocity (if transactional forms of exchange predominate in the collective), or in further stages aspiring to the spiritual (his contribution to the debate), the ability to generate love, affection and mutual trust.¹⁵⁶ As we discuss in Part III, the progressive and graded generation of this ‘psychological oneness’ amongst the residents of Auroville, through administrative, economic, cultural and other means – the subject of *The Ideal of Human Unity* – requires consideration both as a matter of institutional design and individual reflection.

Thus, some regulating influence, from within or without, *is* required. Ideally, fraternity and solidarity substitute the need for rules to co-ordinate and mould individual action; but absent either, gross vitalism risks becoming the dominant pattern of behaviour, leading to a sub-optimal semi-autarchic organization of the collective. This has historically been a concern in Auroville.¹⁵⁷ In the final scheme of things, for Sri Aurobindo, this regulating influence must come from an inner transformation, not an outer regulation. The problem, as we discuss in Parts III and IV, is not finally a question of fixing political machinery from without. That is necessary and underdeveloped in Auroville’s institutional setting, but insufficient. Rather, it is a development from within – only a community of souls who have found a ‘true’ and ‘unperverted human nature’, psychic beings aspiring to a gnostic life, can embody a just equation without the external compulsion of administrative or legal interference (‘rationalistic conventions’).¹⁵⁸ As Mother notes:

The conditions in which men live on earth are the result of their state of consciousness. To seek to change these conditions without changing the consciousness is a vain chimera.¹⁵⁹

To the extent that Auroville’s organization succeeds, it is because its residents are so constituted, so evolved to accept its principles as a reflection of their collective inner state as rational or supra-rational selves. And to the extent it does not, it is because that lies in their forward evolution. Thus, the ‘highest anarchistic ideal’, for Sri Aurobindo, is a move from an ‘original animal association’ to a ‘community of gods’, with an intervening and perhaps long stage of the two democratic conceptions vying for dominance. It is in a reconciliation of the two, a perfection of the democratic ideal – the equal liberty of all operating in a diversified

¹⁵⁴ See, for example, Ripstein, 2008; George, 1995, 83-109; Taylor, 1982, 95-139, Russell, 1934; Russell, 1936.

¹⁵⁵ Kant, 1991; Rawls, 1972.

¹⁵⁶ See, Sri Aurobindo, CWSA, 1997, Vols. 2122, 201-219 for a discussion on the evolutionary pattern of these social forms. It is important question to ask where Auroville lies on this spectrum.

¹⁵⁷ See, for example, Shinn, 1984.

¹⁵⁸ Sri Aurobindo, CWSA, 1997, Vol. 25, 217.

¹⁵⁹ Guigan, 2018, Vol. 1, 42.

harmony – that the subjective view of life, Mother’s Divine anarchy and Sri Aurobindo’s spiritual anarchism, can be prefigured.

To sum up, we provide below a rough and simplified diagrammatic representation of the model of Sri Aurobindo’s evolutionary social and political scheme, which runs in step with the earlier representation of Sri Aurobindo’s ontological scheme. We also note here that this preceding ‘theoretical’ discussion – an unpopular word in Auroville from our limited conversations – is relevant to ground practice. Absent theory, practice is blind, and absent practice, theory is sterile. Theoretical discussions can, if unchecked, become unhelpful and interminable – yet, the opposite too is best avoided:

The endless and seemingly inconsequential character of theoretical discourse has forced ... [us] to make a virtue out of a necessity and turn towards an unreflective pragmatism, with the implicit assumption that the problems of theory are non-problems ...¹⁶⁰

¹⁶⁰ Koskenniemi, 2006, 3.

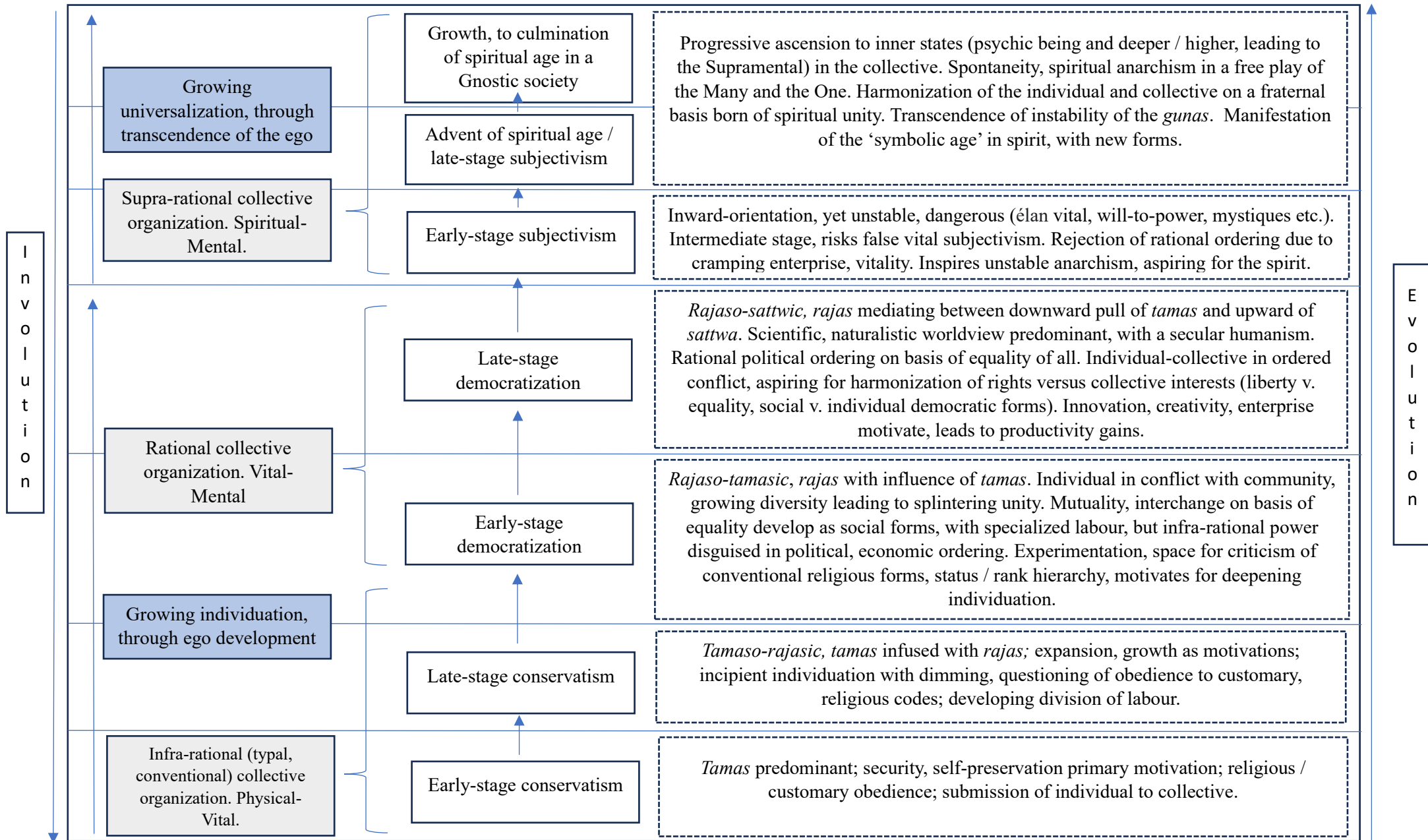

vii. *A Progressive Substitution of Rules with Inner Discipline*

a. *Premature Anarchism*

In this scheme of collective evolution, Sri Aurobindo and Mother provide for the *progressive* substitution of external authority or rules with an inner discipline. Importantly, Sri Aurobindo cautions against a premature attempt at an anarchism that looks to restrain or remove authority and external constraints – the primary discursive rhythm of our conversations on this subject in Auroville – until the inner evolution has proceeded far enough:

The principle of social compulsion may not have been always or perhaps ever used quite wisely, — it is a law of man’s imperfection, imperfect in itself, and must always be imperfect in its method and result: but in the earlier stages of his evolution it was clearly inevitable, and until man has grown out of the causes of its necessity, he cannot be really ready for the anarchistic principle of living.

But it is at the same time clear that the more the outer law is replaced by an inner law, the nearer man will draw to his true and natural perfection. And the perfect social state must be one in which governmental compulsion is abolished and man is able to live with his fellow-man by free agreement and cooperation. But by what means is he to be made ready for this great and difficult consummation? Intellectual anarchism relies on two powers in the human being of which the first is the enlightenment of his reason; the mind of man, enlightened, will claim freedom for itself, but will equally recognise the same right in others. A just equation will of itself emerge on the ground of a true, self-found and unperverted human nature. This might conceivably be sufficient, although hardly without a considerable change and progress in man’s mental powers, if the life of the individual could be lived in a predominant isolation with only a small number of points of necessary contact with the lives of others. Actually, our existence is closely knit with the existences around.¹⁶¹

This point is crucial – anarchism can only be practiced effectively in a collective where inner evolution has proceeded to a stage where external regulation is unnecessary. The default distrust of authority, even if legitimately constructed by agreement, in the Auroville community (in some cases well-articulated and reasonable and in others not so) places a greater responsibility on residents to chasten action to an inner authority, of the psychic self.¹⁶² If desire continues to dictate action *and* an eternal authority is rejected, the anarchism is not of the elevated variety Mother and Sri Aurobindo contemplated, but of a distorted human make.

However, the two – internal and external regulation – are not mutually exclusive: Mother and Sri Aurobindo’s ideal of spiritual anarchism does *not* reject legitimate authority, carefully circumscribed in its domain of expertise. Rather, they propose a shift to the inner authority of each in individual matters, and a system of illumined hierarchies of competence in collective matters. The substitution of illegitimate hierarchy for a legitimate authority that justifies its actions publicly through transparent reasons is now standard course in modern political thinking, with a rich and complex literature that can contribute to the debate in Auroville, an

¹⁶¹ Sri Aurobindo, CWSA, 1997, Vol. 25, 217.

¹⁶² See, for example, Hans, 2023.

area for future research.¹⁶³ However, its translation into life and working social practices is a complex story.¹⁶⁴ As a matter of principle, one may say, as Chomsky carefully puts it:

[This] is what I have always understood to be the essence of anarchism: the conviction that the burden of proof has to be placed on authority, and that it should be dismantled if that burden cannot be met. Sometimes the burden can be met.¹⁶⁵

Where Sri and Aurobindo and Mother tread new ground is in an *empirically* verified *yogic* or psycho-spiritual analysis of the deep-seated causes of collective unfreedom and conflict, and the practical spiritual path forward. Auroville is not the first ‘anarchist’ or ‘utopian’ setup, but it is possibly the first ‘spiritual anarchist’ setup of its size and scale with a nuanced and thoroughly articulated *philosophy of practice* backing it up.¹⁶⁶ Anarchist thinking, in a rough and ready description of a complex and internally variegated tradition has historically struggled to arrive at modes of stable and ordered organization, at workable conceptions of authority, in response to the standard objection of disorder and instability, the troubled debate also in Auroville.¹⁶⁷ Mother and Sri Aurobindo’s move is a careful reconciliation, with an eye to life and practice, of these contraries.

Several discussants expressed an unease with ‘mental forms of organization’ or ‘democracy as usual’, preferring a spontaneous and free advance to this ideal. Caution of premature leapfrogging must be sounded here as well. The problems with democratic ordering, which we discuss below, are well-known, but Sri Aurobindo and Mother do not reject rational ordering of collectives through appropriate institutions and rules, or democratic forms *per se*. They are necessary steps of progress towards a collective spiritual ideal, not barriers:

... the curve of the Age of Reason *naturally* ends by *its own normal* evolution and make ready the ways of a deeper spirit.¹⁶⁸

An easy rejection of reflective mentality, or of the classical virtues, which carried a rhetorical currency in some discussions, is different from a careful and progressive illumination of mentality. The point, as Sri Aurobindo laboured in many letters, is not to ‘[get] rid of the ignorant mentality ... but the divinization of the mind,’ through the progressive opening to the

¹⁶³ See, for helpful summaries, Christiano, 2012; Peter, 2017; Raz, 1986.

¹⁶⁴ This is a complex question relevant to Auroville’s governance, which we do not enter here. It is an exciting area for future research.

¹⁶⁵ Chomsky, 2005, 178.

¹⁶⁶ Devin puts it nicely, ‘[the] question for an Ideal City goes back to the dawn of time. But whenever this ideal – evoked by Plato in his Republic, by Thomas More in his Utopia – ceased to be an (sic) utopia, that is to say as soon as men attempted to translate it into a reality, it always came up against one obstacle and one only: human nature. Those bold endeavours, be they Cabat’s in America or those of Fourier’s disciples in France or elsewhere, have generally been short-lived, as they interrupted by conflicts, schisms, and final a partial or total disintegration – even if one has to recognize that they were fertile grounds rich in various useful experimentations.’ Devin, 25-6, in Arpi (ed.), 2018. This is an exciting and needed area for comparative research in socio-political thought in Auroville. For a discussion on Plato’s utopia, see, Morrison, 2007; for a discussion on the Spanish anarchist collectives, see, Dolgoff, 1974; for Nozick’s famous defence of minarchist libertarianism, see, Nozick, 1974; for Kropotkins’ view of a socialist utopia, see, Kinna, 216, Ch. 5; for a review, see, Chrostowska and Ingram (eds.), 2016.

¹⁶⁷ For a helpful summary, see, Fiala, 2021.

¹⁶⁸ Sri Aurobindo, CWSA, 1997, Vol. 25, 207.

influence of the psychic being on the mental plane.¹⁶⁹ Care must be had then to not confuse the well-intentioned want to operate from states of supra-rationality, yet unattained in the mass, with an anti-rationality that rejects the dictates of reason or refuses to submit to the labour of its rigorous development. An expansion of logic rather than (what at times appeared to be in interviews) an emotive rejection of it requires the perfection of the intellect, a demanding task not to be cast aside easily. As Sri Aurobindo notes:

Ideal conditions [for a spiritual collective are] ... a psychological clarity, a diffused reasonableness and scientific intelligence and, above all, a moral elevation and rectitude to which neither the mass of mankind nor its leaders and rulers have yet made any approach. In their absence, not reason and justice and mutual kindness, but the trend of forces and their practical and legal adjustment must determine the working out of this as of other problems.

...

And, in sum, Science has already enlarged for good the intellectual horizons of the race and raised, sharpened and intensified powerfully the general intellectual capacity of mankind.¹⁷⁰

This means, for example, that in infra-rational modes of collective being, driven by instinct, desire and partiality (reflected in Auroville as elsewhere), a framework of rules and carefully constructed enforcement mechanisms is often necessary. Sri Aurobindo dented the claims of the 'severest school of anarchism' which 'rejects all compromise with communism' – understood here in the sense of a regulatory central authority – with a practical caveat:

difficult to see how ... [this goal] can operate on a large and complex scale necessitated by modern life. And indeed it is not clear how even a free communalism could be established or maintained without some kind of governmental force and social compulsion or how it could fail to fall away in the end either on one side into a rigorous collectivism or on the other to struggle, anarchy and disruption.¹⁷¹

For Sri Aurobindo, the need for legal compulsion ought not be to undervalued in idealistic attempts at anarchism:

For the logical mind in building its social idea takes no sufficient account of the infrarational element in man, the vital egoism to which the most active and effective part of his nature is bound: that is his most constant motive and it defeats in the end all the calculations of the idealising reason, undoes its elaborate systems or accepts only the little that it can assimilate to its own need and purpose ...¹⁷²

The necessity of rules and customs in the passage to the ideal is clear, to avoid an unregenerate liberty – Sri Aurobindo encapsulates his position in these characteristically piquant aphorisms:

The anarchic is the true divine state of man in the end as in the beginning; but in between it would lead us straight to the devil and his kingdom.

¹⁶⁹ Sri Aurobindo, CWSA, 1997, Vol. 28, 177.

¹⁷⁰ Sri Aurobindo, CWSA, 1997, Vol. 25, 77.

¹⁷¹ Sri Aurobindo, CWSA, 1997, Vol. 25, 218; *see also*, Fiala, 2021, Part IV.A.

¹⁷² Sri Aurobindo, CWSA, 1997, Vol. 25, 218.

To observe the law we have imposed on ourselves rather than the law of others is what is meant by liberty in our unregenerated condition. Only in God and by the supremacy of the spirit can we enjoy a perfect freedom.¹⁷³

Mother too is clear and notes pointedly, as a comment on the first aphorism, that a Divine anarchy is *not* the rule of all by all, but of each by herself – this perfect government is only possible when each is conscious of the Divine:

The anarchic state is the government of everyone by himself.

And it will be the perfect government when everyone is conscious of the inner Divine and obeys Him and Him alone.¹⁷⁴

In discussions during our stay, several quoted Mother’s reluctance to rule-making which seems to be in apparent contradiction with Sri Aurobindo’s thinking. For example, Mother makes her distaste for rules clear:

I do not want to make rules for Auroville as I did for the Ashram.

...

I have been asked what the rules are for life in Auroville. Thank God, as yet there are none. As long as there are none, there is hope.¹⁷⁵

The second statement, often quoted (and selectively so) in our conversations, may lead to the conclusion that Mother did not want rules for Auroville *per se*. This is a partial reading. Mother qualifies her remark as follows:

It’s like a progressive victory over all constraints. So naturally ... all the human laws ... all rules, all that grows increasingly supple and finally becomes nonexistent. Yet it is possible to keep a regular rhythm that makes action easier – it’s not contrary to this suppleness ... That may be what the sages of old meant when they spoke of his handing the power of Nature or the power of the Prakriti over to the Purusha – handing it from the Prakriti over to the Purusha.¹⁷⁶

Rules become increasingly supple and finally nonexistent as control is handed over from our desire-laden nature to the soul: outer restriction recedes *as* inner development proceeds, though with as wide as possible an ambit for experimentation, free-discovery, and error.¹⁷⁷ Thus, Mother too notes a progressive substitution of rules in lock step with inner development, and repeatedly emphasizes that people are not in Auroville ‘to do what they like’, *Savitri’s* ‘harsh autonomy’. Her aversion to rule-setting and enforcement is in equal measure to her criticism of desire-laden activity: ‘the freedom we want to realise in Auroville is not license – one doing

¹⁷³ Sri Aurobindo, CWSA, 1997, Vol. 12, 464, 442.

¹⁷⁴ Guigan, 2018, Vol. 2, 61-1.

¹⁷⁵ Guigan, 2018, Vol. 2, 162, 231.

¹⁷⁶ Guigan, 2018, Vol. 1, 227-8.

¹⁷⁷ In this regard, Mother notes: ‘It is Life itself, developing more and more in a progression towards Light, Knowledge, Power, that must little by little establish rules as general as possible, so as to be extremely supple and capable of changing according to need – of changing as rapidly as habits and needs do.’ Guigan, 2018, Vol. 1, 226.

what he pleases without concern for the well-being of the organisation of the whole.’¹⁷⁸ Similarly, She notes:

As it is now, all those who want an easy life and to do what they please as they please, say, ‘Let’s go to Auroville!’ It should be just the opposite. People should know that coming to Auroville means an almost superhuman effort for progress.¹⁷⁹

And again, Mother is clear that discipline towards the rules of a collective ought to come voluntarily – this *builds* liberty, not the opposite, and avoids ‘disorder and confusion’:

Evidently if one has chosen or agreed to live in a community, one must observe the laws of that community, otherwise one becomes an element of disorder and confusion. But a discipline willingly accepted cannot be harmful to the inner development and the growth of the higher consciousness.¹⁸⁰

Mother’s aversion to rules was with the hope that they would be *unnecessary* in Auroville. Her statement is not an argumentative sword to avoid the rigours of discipline, but a shield to preserve space for growth. This finds expression, for example, in an interesting response to an early Auroville resident who wanted to live without ‘rules and laws.’ Mother replied:

Someone from Auroville wrote to me that he thought he had come here to obey no one but himself (or words to that effect), but he noticed there are rules and laws. And he said, ‘I am not going to do any of this; I am a free man and refuse to do this.’ This was reported to me, naturally, so I wrote to him ... ‘One is free only when one is conscious of the Divine and conscious that it is the Divine who makes decisions in everyone, otherwise one is the slave of one’s desires, one’s habits, of all conventions ...’¹⁸¹

On the issue of drugs, for example, Mother is unambiguous that they are ‘prohibited’ in Auroville – the only instance, to the best of our knowledge, where She banned an activity. When pressed about whether this marked a reversal of the second statement above, She replied: ‘Perhaps the Aurovilians have not yet attained the level of consciousness expected of them’, ‘I have said, no drugs in Auroville, and I do not go back on my word. This so-called experience warps the development and damages the consciousness; on the pathway to the Divine it is fall into the rut.’¹⁸² An ideal Auroville for her will not require proscriptive rules, which is not to

¹⁷⁸ Guigan, 2018, Vol. 1, 343.

¹⁷⁹ Guigan, 2018, Vol. 2, 360.

¹⁸⁰ Guigan, 2018, Vol. 1, 413.

¹⁸¹ Guigan, 2018, Vol. 2, 61.

¹⁸² Guigan, 2018, Vol. 2, 232, 246. We have been informed anecdotally in conversations that drug usage is prevalent in Auroville, either recreationally or as part of youthful experimentation. If so, this is a breach of Mother’s words that deserves immediate and strong action. Some discussants involved in the educational sector also informed us that the issue is not of individual usage, but a culture amongst sections of the youth, with adult acquiescence or support. We were not able to locate any reports to this effect or verify the claims otherwise; if this is so, the developmental effects of such a culture on minors and young adults can be serious and ought to be addressed on priority. Fostering a facilitative public culture, as we noted above, is all important – the issue in case of the youth is not simply one of a formal ban or of imposing penalties, but a robust programme, including education, community discussions and support, with rehabilitation where necessary, to address the problem. Aside from the legal considerations, the issue is not primarily moral but of the harmful developmental effects. As Mother notes: ‘The people who live in Auroville and insist on following all the old habits – the old ones and the new ones too – which harm the consciousness, which lower the consciousness, things like smoking, drinking

say that it may not need them, unfortunate as that occurrence may be, at points for well-defined purposes.¹⁸³

b. *Perilous but Fruitful: The Move from External to Internal Authority*

Thus, the move to the Divine anarchy posits a *progressive*, rather than *immediate*, substitution of external authority – with a mix of soft and hard modes of enforcement, an open and under-researched question in Auroville today – with an inner discipline. It is only when the *sattvik* and spiritual poise develops sufficiently in the collective – a yet unrealized occurrence at scale, including in Auroville – that such external rules can be done away with. This is not a naïve rejection of legal schemes, but an ideal in which they become *unnecessary* when replaced by an even more demanding inner discipline. As we discuss in Parts III and IV, this bears on governance practices in Auroville, particularly in the anti-rule orientation common in the community that has led to a resistant centralization of executive and legislative authority.

Indeed, the move to reject external authority is reasonable and proper – it is, as Sri Aurobindo notes, a characteristic of the democratic conception of ‘age of reason,’ to be perfected in anarchist setups:

He has to rise in revolt; on every claim of authority he has to turn the eye of a resolute inquisition ... And of all you say, still I must ask, does it agree with the facts of the world, with my sense of right, with my judgment of truth, with my experience of reality?¹⁸⁴

Yet, Sri Aurobindo characterizes this subjective movement as a ‘perilous but fruitful adventure’.¹⁸⁵ The rejection of external authority does *not* guarantee the discovery of self-authenticating internal authority – to the contrary, it may result in a gross vital anarchism, unconstrained by the partially civilizing influence of social convention. As we note below, this is apparent in several fora in Auroville. A premature replacement of external compulsion without the corresponding inner development risks turning the idea of a free and spontaneous cooperation of all, the Divine anarchy, into an egoistic autarchy of many. Sri Aurobindo is explicit on this point:

Manifestly, the unrestrained use of individual illumination or judgment without either any outer standard or any generally recognisable source of truth is a perilous experiment for our imperfect race. It is likely to lead rather to a continual fluctuation and disorder of opinion than to a progressive unfolding of the truth of things ... [It] may end in an exaggerated assertion of the will in each to live his own life and to satisfy his own ideas and desires which will produce a serious malaise or a radical trouble in the social body ...¹⁸⁶

and, of course, drugs... all that, it is as if you were cutting pieces off your being. In the Ashram, naturally, I said no. We want to grow in consciousness; we do not want to descend into the pit of desires. To those who refuse to understand, I say: the aim of Auroville is to discover a new, deeper, more complete, more perfect life and to show the world that tomorrow will be better than today.’ Guigan, 2018, Vol. 2, 162.

¹⁸³ An important distinction must be made between proscriptive rules and those geared to solve coordination problems. This was often elided in our discussions in Auroville, as we discuss in Part IV.

¹⁸⁴ Sri Aurobindo, CWSA, 1997, Vol. 25, 17.

¹⁸⁵ Sri Aurobindo, CWSA, 1997, Vol. 25, 44.

¹⁸⁶ Sri Aurobindo, CWSA, 1997, Vol. 25, 19.

As we discuss in Parts III and IV, claims made to dictate collective decision-making in Auroville, through the Residents' Assembly or Working Groups, must guard against this tendency to disguise individual preference and desire in the name of self-government or participatory democracy (through the requirement of consensus, for example). This tendency is natural in any collective, but for one that is committed to a growing subjectivism like Auroville, Sri Aurobindo's distinction between true and false subjectivism is timely. A true subjectivism is a progressive expansion of the ego-self to the psychic being 'in solidarity with all of his kind,' supported by the 'ideal conditions' of a 'psychological clarity, a diffused reasonableness and scientific intelligence and, above all, a moral elevation and rectitude.'¹⁸⁷ A false subjectivism aggrandizes the egoistic will-to-be in the disguise of an inner seeking, with historically disastrous consequences in the form of irrationalism.¹⁸⁸ As Sri Aurobindo notes:

Our object is not to remove all 'limitations' on the expansion of the ego or to give a free field and make unlimited room for the fulfilment of the ideas of the human mind or the desires of the ego-centred life-force. None of us are here to 'do as we like', or to create a world in which we shall at last be able to do as we like; we are here to do what the Divine wills and to create a world in which the Divine Will can manifest its truth no longer deformed by human ignorance or perverted and mistranslated by vital desire.¹⁸⁹

By comparison, Sri Aurobindo places Auroville's ideal before us in the following summary of its discussion, worth quoting at length:

... there is a common life, a common work, a common effort and aspiration without which humanity cannot grow to its full height and wideness. To ensure coordination and prevent clash and conflict in this constant contact another power is needed than the enlightened intellect. Anarchistic thought finds this power in a natural human sympathy which, if it is given free play under the right conditions, can be relied upon to ensure natural cooperation: the appeal is to what the American poet calls the love of comrades, to the principle of fraternity, the third and most neglected term of the famous revolutionary formula. A free equality founded upon spontaneous cooperation, not on governmental force and social compulsion, is the highest anarchistic ideal.

But it is also possible that our progress has not been a development in a straight line, but in cycles, and that in those cycles there have been periods of at least partial realisation in which men did become able to live according to the high dream of philosophic Anarchism, associated by the inner law of love and light and right being, right thinking, right action and not coerced to unity by kings and parliaments, laws and policings and punishments with all that tyrant unease, petty or great oppression and repression and ugly train of selfishness and corruption which attend the forced government of man by man. It is even possible that our original state was an instinctive animal spontaneity of free and fluid association and that our final ideal

¹⁸⁷ Sri Aurobindo, CWSA, 1997, Vol. 25, 47, 396.

¹⁸⁸ See, for a review of the dangers of irrationalism, Lukács, 1952. In general, mistaking vital experiences for spiritual ones is an error Mother and Sri Aurobindo were careful to counsel against. For example, Mother noted: 'I get ten-page letters telling me "spiritual experiences" – which are completely in the vital. They don't understand a thing. Even in Auroville they're like that, they don't understand.' Guigan, 2018, Vol. 2, 234.

¹⁸⁹ Sri Aurobindo, CWSA, 1997, Vol. 30, 1313-14.

state will be an enlightened, intuitive spontaneity of free and fluid association. Our destiny may be the conversion of an original animal association into a community of the gods. Our progress may be a devious round leading from the easy and spontaneous uniformity and harmony which reflects Nature to the self-possessed unity which reflects the Divine.¹⁹⁰

He notes the ills of ‘selfishness which attend the forced government of man by man,’ the seed of the spontaneity-driven anarchist ideal outlined by Mother and reflected in Auroville’s political rhetoric at present. And yet, like Mother, he cautions that its flowering depends on a demanding inner evolution that alone can ground a solid foundation of brotherhood, yet to be achieved in Auroville today. On her part, Mother too was acutely aware of this problem:

One lives in Auroville in order to be free from moral and social conventions; but this freedom must not be a new slavery to the ego, to its desires and ambitions.¹⁹¹

It is worth remembering here that Mother often remarked that some early Aurovilians had misunderstood this distinction. For example, she noted pungently, but with characteristic humour, that ‘there’s really a subhuman group over there,’ and lamented that ‘they’re all quarrelling among themselves! And some even disobey deliberately; they refuse to recognise any authority.’¹⁹² Elsewhere, she laid particular emphasis on the fact that ‘discipline is indispensable,’ which made some ‘terribly angry,’ even mooted at one point (during a roving private conversation) a ‘drastic’ step to insist on ‘so many hours of work per day are required in order to be fed.’¹⁹³ And emphatically, she once noted:

They don’t understand a thing. Even in Auroville they’re like that, they don’t understand ... And then quarrels over nothing ... oh, a subhumanity! ... You see, they are grossly ignorant; they come here without experience, without knowledge, without preparation, and they think they are going to realise the Supermind right away ... It’s really pathetic. Some things are ... they display reactions and attitudes one would be ashamed of in ordinary life. They need something to straighten them out.¹⁹⁴

As we discuss in Part IV.E, the question of enforcement by a legitimate authority is to be carefully weighed against the competing interests to freedom to err and disagree – at any rate, in the ideal, it is the force of the spiritual atmosphere that places pressure to align or exit, with hard enforcement being the option of last resort. A chastening of action to inner authority *pro tanto* diminishes the need for external enforcement; yet, rejecting the latter while the former has not been established is a risky affair. The issue, in practical terms, will boil down to the interplay of two enforcement approaches: on one hand, a flexible, yet firm, regulatory architecture that can guide and where necessary, proscribe, without breaching the necessary latitude and space for experimentation; and on the other, a public sphere that can exert pressure in micro-environments where daily interchange occurs, to align and mould behaviour by the strength of the collective consciousness. It is ultimately the force of the atmosphere, if consecrated, that best decides whether one is compelled. Yet, till that concentration of force is

¹⁹⁰ Sri Aurobindo, CWSA, 1997, Vol. 25, 292.

¹⁹¹ Guigan, 2018, Vol. 2, 145.

¹⁹² Guigan, 2018, Vol. 2, 327.

¹⁹³ Guigan, 2018, Vol. 2, 248-254.

¹⁹⁴ Guigan, 2018, Vol. 2, 234.

built up, the twin play of outer regulation and inner compulsion will require sensitive handling to navigate the perilous but necessary shift from external to internal authority.

Thus, to sum up, we note that the route to a philosophic anarchism anticipates the progressive, but careful and timely, substitution of external authority with inner discipline, with a wise cautionary note that this turn inward (i) still requires illumined authority to which the collective voluntarily submits; (ii) must not fall foul of a false vital subjectivism or (iii) prematurely cast away the need for narrow crafted and sensitive legal compulsion and finally (iv) one that depends for its success on a spiritually vibrant and nurturing public culture that signals out licentious activity, with a wide margin for error, experimentation and plurality of life forms.

*

D. ARRANGEMENT OF PRODUCTIVE LIFE

An integral part of Mother's vision is the practical arrangement of productive life in Auroville. She notes:

Individual worth would have a far greater importance than that of material wealth and social standing. There, work would not be a way to earn one's living but a way to express oneself and to develop one's capacities and possibilities while being of service to the community as a whole, which, for its own part, would provide for each individual's subsistence and sphere of action.

Mother's vision speaks of five aspects insofar as productive life is concerned, which we discuss briefly below:

1. Work done as offering in the spirit of *karma* yoga to find and express one's higher self, rather than a transaction for wages or competitive growth.
2. The arrangement of productive life on a mutuality of need and capacity, and not on a levelling-down equality.
3. A culture of material abundance, but not excess, based on innovation-led, tertiary production.
4. A progressive substitution of individual or collective ownership and possession with 'Divine ownership.'
5. A governance model based on service, rather than right, with hierarchies based on technical and spiritual competence, rather than status.

i. Work as Aspiration and Offering

Mother's ideal of work was labour conducted in the spirit of offering to the Divine, *karma* yoga, a means of spiritual growth to one's higher self, rather than a transaction for wages for sustenance or a 'vital' aggrandizement of achievement. The alienation and self-estrangement from work and a growing means-end instrumentalism, on one hand, and a culture of competitive success and expansion, on the other – both discussed at length in Sri Aurobindo's *Human Cycle* as also other thinkers – animated Mother's mind as she spoke of rescuing labour (and as we note below, capital) as a tool for growth. Sri Aurobindo's discussion on the discovery of one's *svadharma* in his *Essays on the Gita* addresses this idea – of the link between work and self-discovery – is instructive:

At the very start it [the Gita] has spoken of the nature, rule and function of the Kshatriya as Arjuna's own law of action, *svadharma*; it has proceeded to lay it down with a striking emphasis that one's own nature, rule, function should be observed and followed, —... To follow the law of another's nature is dangerous to the soul, contradictory, as we may say, to the natural way of his evolution, a thing mechanically imposed and therefore imported, artificial and sterilising to one's growth towards the true stature of the spirit. What comes out of the being is the right and healthful thing,

the authentic movement, not what is imposed on it from outside or laid on it by life's compulsions or the mind's error.¹⁹⁵

Conceived so, work is no longer an instrument of what Sri Aurobindo calls 'economic barbarism' – concerned solely with satisfaction of vital desires, production for the sake of consumption and accumulation – but an instrument of ascension to the higher self.¹⁹⁶ Coming in the wake of the 'limits to growth' and 'return to nature' movements of the 1970s, with a continued though somewhat diminished appeal today, this reframing of the motives of work in Mother's 'Dream' – from individual desire for gain, profit and possession to a spiritual end – is radical, easily stated and difficult to practice. The placement of individual desire or self-interest in relation to productive work has been the subject of deep debate, and a constant source of worry for several thinkers, as this alleged 'vice' of the *rajasic* temper fuels activity, growth and innovation, and a 'religious' devaluation of desire is at worst a falling back into *tamas* or at best, a hypocritical disguise. Sri Aurobindo is acutely aware of this debate – he recognizes the need and necessity of the *rajasic* temper, and (as a starting point) desire-driven activity:

... the Life within us ... is the strongest kinetic motor power, but the life-power in earthly beings is possessed by the force of desire, therefore rajas turns always to action and desire; desire is the strongest human and animal initiator of most kinesis and action, predominant to such an extent that many consider it the father of all action and even the originator of our being. Moreover, rajas finding itself in a world of matter which starts from the principle of inconscience and a mechanical driven inertia, has to work against an immense contrary force; therefore its whole action takes on the nature of an effort, a struggle, a besieged and an impeded conflict for possession which is distressed in its every step by a limiting incapacity, disappointment and suffering: even its gains are precarious and limited and marred by the reaction of the effort and an aftertaste of insufficiency and transience.¹⁹⁷

The limitations of *rajas* – its turbid functioning and imperfect attempt at possession, leading to competitive conflict – are to be transcended by a purification, not rejection:

The gunas have to be transcended if we would arrive at spiritual perfection. Tamas evidently has to be overcome, inertia and ignorance and incapacity cannot be elements of a true perfection; but it can only be overcome in Nature by the force of rajas aided by an increasing force of sattwa. Rajas has to be overcome, egoism, personal desire and self-seeking passion are not elements of the true perfection; but it can only be overcome by force of sattwa enlightening the being and force of tamas limiting the action. Sattwa itself does not give the highest or the integral perfection; sattwa is always a quality of the limited nature; sattwic knowledge is the light of a limited mentality; sattwic will is the government of a limited intelligent force. Moreover, sattwa cannot act by itself in Nature, but has to rely for all action on the aid of rajas, so that even sattwic action is always liable to the imperfections of rajas; egoism, perplexity, inconsistency, a one-sided turn, a limited and exaggerated will, exaggerating itself in the intensity of its limitations, pursue the mind and action even of the saint, philosopher and sage. There is a sattwic as well as a rajasic or tamasic

¹⁹⁵ Sri Aurobindo, CWSA, 1997, Vol. 19, 508-9.

¹⁹⁶ This is now a recognized concern globally, though naturally with a varying understanding of the 'higher self'. See, Part III.F.

¹⁹⁷ Sri Aurobindo, CWSA, 1997, Vols. 23-24, 685.

egoism, at the highest an egoism of knowledge or virtue; but the mind's egoism of whatever type is incompatible with liberation. All the three gunas have to be transcended.¹⁹⁸

Sri Aurobindo and Mother's vision neither rejects desire or *rajas*, nor does it defang it by a spiritual sheen; rather, it looks to evolve or purify it – the *pranic* force that impels action, the *vāhana* or 'steed and conveyance of the embodied mind and mill' – with the promise of spiritual return through the practice of *karma* yoga.¹⁹⁹ Commenting on the transformation, not rejection, of the desire-soul, Sri Aurobindo notes:

Then again there is the ... desire soul; this too calls for its own perfection. Here too the *first necessity is a fullness of the vital capacity* in the mind, its power to do its full work, to take possession of all the impulses and energies given to our inner psychic life for fulfilment in this existence, to hold them and to be a means for carrying them out with strength, freedom, perfection. Many of the things we need for our perfection, courage, will-power effective in life, all the elements of what we now call force of character and force of personality, depend very largely for their completest strength and spring of energetic action on the fullness of the psychic prana ... [But, the] desire-soul must get rid of the clamour, insistence or inequality of its desires in order that its desires may be satisfied with justice and balance and in the right way and eventually must rid them of the character of desire altogether and change them into impulses of the divine Ananda. To that end it must make no demands nor seek to impose itself on heart, mind or spirit, but accept with a strong passive and active equality whatever impulsion and command come into it from the spirit through the channel of a still mind and a pure heart. And it must accept too whatever result of the impulse, whatever enjoyment more or less, full or nil, is given to it by the Master of our being. At the same time, possession and enjoyment are its law, function, use, swadharma. It is not intended to be a slain or mortified thing, dull in its receptive power, dreary, suppressed, maimed, inert or null.²⁰⁰

Auroville forms an experimental ground for this all-important debate, a testing field, and if it comes to pass, source of validation, for the principles of *karma* yoga in a modern city-context. No large city-wide collective has translated Sri Aurobindo's clarion call, 'all life is yoga,' into action: that task is Auroville's. As Mother notes:

Auroville is created to realise the ideal of Sri Aurobindo who taught us the Karma yoga. Auroville is for those who want to do the Yoga of work. To live in Auroville, means to do the Yoga of work. So all Aurovilians must take up a work and do it as Yoga.²⁰¹

Sri Aurobindo in turn places the ideal of the 'Yoga of work' before us thus:

A man, it goes on to say, who devotes himself to his own natural work in life acquires spiritual perfection, not indeed by the mere act itself, but if he does it with right knowledge and the right motive, if he can make it a worship of the Spirit of this creation and dedicate it sincerely to the Master of the universe from whom is all

¹⁹⁸ Sri Aurobindo, CWSA, 1997, Vols. 23-24, 687-8.

¹⁹⁹ Sri Aurobindo, CWSA, 1997, Vols. 23-24, 734.

²⁰⁰ Sri Aurobindo, CWSA, 1997, Vols. 23-24, 734-5 (emphasis ours).

²⁰¹ Guigan, 2018, Vol. 2, 467.

impulse to action. All labour, all action and function, whatever it be, can be consecrated by this dedication of works, can convert the life into a self-offering to the Godhead within and without us and is itself converted into a means of spiritual perfection. But a work not naturally one's own, even though it may be well performed, even though it may look better from the outside when judged by an external and mechanical standard or may lead to more success in life, is still inferior as a means of subjective growth precisely because it has an external motive and a mechanical impulsion. One's own natural work is better, even if it looks from some other point of view defective. One does not incur sin or stain when one acts in the true spirit of the work and in agreement with the law of one's own nature. All action in the three *gunas* is imperfect, all human work is subject to fault, defect or limitation; but that should not make us abandon our own proper work and natural function. Action should be rightly regulated action, *niyatam karma*, but intrinsically one's own, evolved from within, in harmony with the truth of one's being, regulated by the Swabhava, *svabhava-niyatam karma*.²⁰²

ii. *Mutuality and Qualified Egalitarianism*

Mother's arrangement of productive life operates on an easy to articulate, yet notoriously difficult to practice, mutuality. Echoing the communist formula ('with a twist'), 'to each is to give according to his need, from each according to his capacity', Mother notes that each person must take up productive work (later noting for five hours per day, except Sundays) that benefits the community, whilst the community provides for sustenance.²⁰³ In this, Mother conceptualizes a distributive system that supports egalitarian access to public goods – education, healthcare, civic services, etc., and aesthetic goods – required for human flourishing.²⁰⁴ Each individual is to offer voluntarily to the collective (the 'contribution' system), and the collective in return is to provide an egalitarian access to the basic goods necessary sustenance and flourishing (the 'prosperity' ideal, a form of linked social security or universal basic income, which is yet to be clearly specified in Auroville, discussed in Part III.F).

Mother's discussion emphasizes two aspects. First, that the offering to the collective is not to be standardized as far as possible, but tailored to individual circumstance (thus allowing for material diversity, which places pressure on inequality-linked solidarity concerns in the extreme), and second, that this offering should ideally be voluntary and not coerced. She notes in an important exchange in the *Agenda*:

One's participation in the welfare and existence of the whole township isn't something worked out individually: such and such an individual must give so much. It's not like that. It's worked out according to one's means, activity, possibilities of production; it's not the democratic idea, which cuts everything into small equal bits – an absurd machinery. It's worked out according to one's means: one who has much

²⁰² Sri Aurobindo, CWSA, 1997, Vol. 19, 509-10.

²⁰³ Interestingly, there is a parallel with Thomas Moore's very different utopian setup in 1516, from which comes the name: utopians work only six hours a day, where 'leisure time is spent, not in consumption (there is nothing much to consume) but in 'learning joyously, in debating, in reading, in reciting, in writing, in walking, in exercising the mind and body, and with play.' See, Skidelsky, 2012, 62 for a discussion on work, leisure and utopian ideals.

²⁰⁴ Mother, 1954 ('Beauty in all its artistic forms, painting, sculpture, music, literature, would be equally accessible to all; the ability to share in the joy it brings would be limited only by the capacities of each one and not by social or financial position.')

gives much, one who has little gives little; one who is strong works a lot, one who isn't does something else. You understand, it's something truer, deeper ... This sentence, for instance: 'All who live there will participate in its life and development ...' ... according to their capacities and means, not a mechanical 'so much per unit.' That's the point. It must be something living and true, not mechanical.²⁰⁵

The industries will participate actively, they will contribute. If they are industries producing articles that aren't in constant need – and are therefore in amounts or numbers too great for the township's own use, so that they will be sold outside – those industries must naturally participate through money. And I take the example of food: those who produce food will give the township what it needs (in proportion to what they produce, of course), and it is the township's responsibility to feed everyone. That means people won't have to buy their food with money, but they will have to earn it. It's a kind of adaptation of the Communist system, but not in a spirit of levelling: according to everyone's capacity, his position (not a psychological or intellectual one), his inner position.²⁰⁶

There will be no taxes as such but each will contribute to the collective welfare in work, kind or money. So that's clear: there will be no taxes of any kind, but everyone will have to contribute to the collective welfare through his work, in kind or with money. Those who have nothing other than money will give money.²⁰⁷

Mother's ideal bears as a close resemblance to Sri Aurobindo's description of a 'free cooperative communism':

... this would seem to lead us either towards a free cooperative communism, a unified life where the labour and property of all is there for the benefit of all, or else to what may better be called communalism, the free consent of the individual to live in a society where the just freedom of his individuality will be recognised, but the surplus of his labour and acquisitions will be used or given by him without demur for the common good under a natural cooperative impulse.²⁰⁸

Two issues are striking in Mother's words. The first is that one's sustenance is not 'free', but earned reciprocally through contributions. But the nature of these contributions must be determined according to individual capacity and not standard metrics that would create hierarchies of competitive success. If A gives more than B, yet each give according to their capacity, no difference lies in what they get. That depends on their needs, which may not necessarily be in proportion to their contributions. The big practical problem of organization here is of a mechanism to identify these capacities and needs at-scale. And the second is that such contributions should be voluntary (not coerced, as taxation systems are), ideally as an offering in the spirit of *karma* yoga, but (i) Mother here does not provide guidance on free-rider concerns and (ii) the translation of this inner offering to an outer offering under the AVF Act, 1988 that places all assets in the Foundation presents a further complication.

As Sri Aurobindo discusses at length, this simple, benign formulation of the relationship between the individual and collective presents serious difficulties in practice, as is the case in

²⁰⁵ Guigan, 2018, Vol. 1, 223.

²⁰⁶ Guigan, I 225.

²⁰⁷ Guigan, 2018, Vol. 1, 224.

²⁰⁸ Sri Aurobindo, CWSA, 1997, Vol. 25, 218.

Auroville, which we discuss in Part III.F. These include the identification of metrics for what is productive work, identification of the nature and amount of collective offering (the ‘contribution’ system), identification of the nature and amount of community support through the ‘prosperity’ scheme (the ‘maintenances’ system), mechanisms for assessing variation in needs and capacity to avoid a levelling down common to collective management enterprises (allocation of investment and housing stock, for example), enforcement, in case ‘free consent’ is not forthcoming, and the problem of free-riders (*de facto* taxation under the Code of Conduct, and voluntary compliance mechanics), the nature of bureaucratic ordering of the collective to manage affairs (the operating practices of finance-related ‘Working Groups’), the relationship between individual enterprise and collective management of finances, concentration of power in collective management, stunting enterprise and commercial freedoms common to egalitarian arrangements etc. The problem lies in evidence-led practical policy specifications and conventions, not in metaphysical debates.

Auroville’s challenge here is not exceptional – these questions are debated in a long-standing and vigorous literature. Yet its answer, with the practice of the collective yoga, may be so. A comparative historical survey is an important research need in Auroville for its own systems design.²⁰⁹ As we suggest in Part III.F, there is a felt need for an independent, empowered group with economic expertise to draft, consult and execute a phased economic plan that can translate Mother’s words, often expressed at a level of generality, into a coherent body of practices that can sustain a capital intensive, innovation-led knowledge-economy consistent with Auroville’s research aspirations. The challenge is in spiritualizing production at scale, navigating the natural ills of greed, acquisitiveness and competition, on one hand, and an egalitarian levelling-down or stunting rejection of ‘money’, on the other.

That said, the ideal – what Sri Aurobindo elsewhere calls a ‘Vedantic socialism’ – is simply stated:

The right organisation of social life on a basis of equality and comradeship ought to give each man his proper place in society, his full training and development for the common ends, his due share of work, leisure and reward, the right value of his life in relation to the collective being, society.²¹⁰

iii. Reclaiming Production and a Culture of Abundance

The economic model of Auroville lends itself to an innovation-driven collaborative exchange that generates a sufficient surplus for a ‘simply rich and beautiful life for all’, rather than a market-driven competitive order operating on an engine of unreflective gains in productivity. A natural response to the ‘gross vitalism’ of societies devoted predominantly to commercial ends and consumption-led behaviour could be a relatively quietistic return to a simpler, ascetic

²⁰⁹ See, for example, Russell, 1934; Avineri, S., and de-Shalit, A., (eds), 1992; Taylor, 1989.

²¹⁰ Sri Aurobindo, CWSA, 1997, Vol. 25, 208. Sri Aurobindo puts it simply in this aphorism, pointing to a deep overlapping consensus among various traditions, characteristic of his syncretic approach: ‘Vedanta realised is the only practicable basis for a communistic society. It is the kingdom of the saints dreamed of by Christianity, Islam and Puranic Hinduism.’ Sri Aurobindo, CWSA, 1997, Vol. 12, 465.

mode, with a distaste for money exchange (a feature common in our conversations in Auroville, though not necessarily translated into practice). Indeed, Sri Aurobindo decries

the reign of commercialism ... increase of production and interchange, this desire for commodities and markets and this piling up of a huge burden of unnecessary necessities.²¹¹

As we discuss in Part III.F, the under-development of the commercial sector in Auroville can be traced in part as a reaction to the unchecked commercialism and greed, as a reaction to predominantly profit and productivity-oriented market-systems elsewhere. This rejection – of what Mother calls ‘money relations’, where wealth dictates status – is proper but partial. In an important and broad-ranging passage in the *Human Cycle*, Sri Aurobindo notes:

His [the modern man’s] idea of civilisation is comfort, his idea of morals social respectability, his idea of politics the encouragement of industry, the opening of markets, exploitation and trade following the flag, his idea of religion at best a pietistic formalism or the satisfaction of certain vitalistic emotions. He values education for its utility in fitting a man for success in a competitive or, it may be, a socialised industrial existence, science for the useful inventions and knowledge, the comforts, conveniences, machinery of production with which it arms him, its power for organisation, regulation, stimulus to production. The opulent plutocrat and the successful mammoth capitalist and organiser of industry are the supermen of the commercial age and the true, if often occult rulers of its society. The essential barbarism of all this is its pursuit of vital success, satisfaction, productiveness, accumulation, possession, enjoyment, comfort, convenience for their own sake. The vital part of the being is an element in the integral human existence as much as the physical part; it has its place but must not exceed its place. A full and well-appointed life is desirable for man living in society, but on condition that it is also a true and beautiful life. Neither the life nor the body exist for their own sake, but as vehicle and instrument of a good higher than their own. They must be subordinated to the superior needs of the mental being, chastened and purified by a greater law of truth, good and beauty before they can take their proper place in the integrality of human perfection. Therefore in a commercial age with its deal, vulgar and barbarous, of success, vitalistic satisfaction, productiveness and possession the soul of man may linger a while for certain gains and experiences, but cannot permanently rest. If it persisted too long, Life would become clogged and perish of its own plethora or burst in its straining to a gross expansion. Like the too massive Titan it will collapse by its own mass, *mole ruet sua*.²¹²

Sri Aurobindo’s criticizes vitalism if it supports production for the sake of production, an unnecessary multiplication of desire for convenience driven by industrial growth, a vulgar utilitarianism, a competitive fight for material success and domination. As we noted above, this pattern of behaviour, which he elsewhere calls a ‘a strictly economic society,’²¹³ cramps liberty in its system of ordered production and sows the seeds for its own replacement, giving rise to anarchist impulses looking to recover that lost liberty:

²¹¹ Sri Aurobindo, CWSA, 1997, Vol. 25, 607.

²¹² Sri Aurobindo, CWSA, 1997, Vol. 25, 80.

²¹³ Sri Aurobindo, CWSA, 1997, Vol. 25, 22.

The attempt to govern and organise human life by verifiable Science by a law, a truth of things, an order and principles which all can observe and verify in their ground and fact and to which therefore all may freely and must rationally subscribe, is the culminating movement of European civilisation. It has been the fulfilment and triumph of the individualistic age of human society; it has seemed likely also to be its end, the cause of the death of individualism and its putting away and burial among the monuments of the past.²¹⁴

In this, Sri Aurobindo anticipates criticisms levelled by many in recent times against unchecked market growth – for example, as Skidelsky notes in his review of economic policy,

... the insatiability of human wants ... produce an ethic of acquisitiveness, which dooms societies to continuous, objectless, wealth-creation ...

The ideal of economic growth as an end without an end ... [where] there were no other objects of economic policy left ... survives only because we have lost a sense of what wealth is for, a language of the good life ...

What would an economic organization geared to realizing the basic goods look like? It would have to produce enough goods and services to satisfy everyone's basic needs and reasonable standards of comfort. It would furthermore have to do so with a big reduction in the amount of necessary work, so as to free up time for leisure, understood as self-directed activity.²¹⁵

In this spirit, Sri Aurobindo is categorical that commerce and production are to be re-aligned as a 'vehicle and instrument of a good higher than their own,' 'subordinated ... purified by a greater law of truth, good and beauty.' In other words, commerce is not to be shunned, but 'reconquered for the Divine', the means made to serve proper and higher ends:

Money is the visible sign of a universal force, and this force ... is indispensable to the fullness of the outer life. In its origin and its true action it belongs to the Divine. But ... it is delegated here and in the ignorance of the lower Nature can be usurped for the uses of the ego ... For this reason most spiritual disciplines insist on a complete self-control, detachment and renunciation of all bondage to wealth and of all personal and egoistic desire for its possession. Some even put a ban on money and riches and proclaim poverty and bareness of life as the only spiritual condition. But this is an error ... To reconquer it for the Divine ... is the supramental way ...²¹⁶

Production, enjoyment and mutuality are, as he notes, an essential part of a social body, the *vaishya* quality, if chastened to the spiritual ideal:

The aim of its [a spiritual society's] economics would be not to create a huge engine of production, whether of the competitive or the cooperative kind, but to give to men – not only to some but to all men each in his highest possible measure – the joy of work according to their own nature and free leisure to grow inwardly, as well as a simply rich and beautiful life for all.²¹⁷

²¹⁴ Sri Aurobindo, CWSA, 1997, Vol. 25, 20-1.

²¹⁵ Skidelsky and Skidelsky, 2013, 601.

²¹⁶ Sri Aurobindo, CWSA, 1997, Vol. 32, 10.

²¹⁷ Sri Aurobindo, CWSA, 1997, Vol. 25, 257.

In his nationalist days, which provide a practical orientation to this debate, Sri Aurobindo warned against an excessively material culture that had occupied the West in its industrialization. Yet, his *Bande Mataram* and *Karma Yogin* recorded an almost religious fervour for material progress – he wanted to modernize, set up industry, develop technology and have strong urban centres. These were imperative goals where India could learn from the West’s advance charge. The life-denying, ascetic form of religion that had marked the Indian mentality was not the ideal of the future. What he was concerned about was the greed, selfishness and feeling of alienation from one’s fellow beings that market cultures can lead to, if one succumbs to a hedonistic excess driven by an unchecked competitive market mechanism. A spiritual culture, devoted to the highest good in man beyond the insatiable desire of individual pleasure and material gain – relinquished with calculated concessions of self-interest in favour of the common good – can use the fruits of the economy, with an equitable distribution of resources anchored by an inner spiritual urge to help others, *siva jnana jiver seva* – the ethical instinct to serve one’s fellow being as a manifestation of Divinity.

As we discuss in Part II below, Mother similarly advocates a culture of production and abundance but not excess for Auroville, an economically self-sustaining city driven by industry, commerce and food production, rich in material terms. Importantly, her economic vision for Auroville is tied to its educational one. The purpose of economic production is to meet material needs and create sufficient comfort to free time for higher pursuits rather than engage in the production of ‘unnecessary necessities’:

When I was in France, I was always asking myself, ‘How can people have the time to find themselves? How can they even have the time to understand the way to free themselves?’ So I thought: a place where material needs are sufficiently satisfied, so that if you truly want to free yourself, you can do so. And it was on this idea that the Ashram was founded, not on any other: a place where people’s means of existence would be sufficient to give them the time to think of the True Thing ...

...

Ultimately, [Auroville] must be a town for studies – studies and research on how to live both in a simplified way and in a way such that the higher qualities have more time to develop.²¹⁸

Practically speaking, this important passage begs the question: what is base level of material necessities? How much is enough? How does the purification of desire for material goods and products interact with Auroville’s commercial profile? This profile, one may say, must be guided by an assessment of needs rather than wants, with measures to attract the right form of investment and talent to meet that minimum level of material necessities for all. This was a task that Mother anticipated in a 1968 letter to the Ford Foundation discussed below, but is yet to be done. As we note in Part III.F, to the extent that this reluctance to develop the commercial sector at scale relates to an unease with surplus or ‘profit’ generation in the community, it is not in keeping with this spirit of reclaiming, rather than shunning, capital.

²¹⁸ Guigan, 2018, Vol. 1, 28-9.

We may also note here that lively debates on the relationship of work, production and leisure to the broader goals of human flourishing – echoing Mother and Sri Aurobindo’s words – are to be found in recent scholarly literature.²¹⁹ These debates are had on the future of work in the wake of technology-supported increases in productivity and consumption-led market arrangements.²²⁰ Auroville’s establishment was co-terminus with these debates, or in some cases, ahead of its time. These concerns have since been the subject of cutting-edge research. Meaningful dialogue with this emerging body of thought is required in Auroville to (as the Charter notes) take ‘advantage of all discoveries,’ and to avoid a backward-looking nostalgic exceptionalism often expressed in our discussions.

iv. Renunciation as Ownership

Mother’s vision excludes ownership of property, assets or profit – ‘Auroville belongs to nobody.’ This is a bold practical expression of the idea of Vedantic socialism, where property is neither individually *nor* communally owned. Legally, all lands and other assets vest in the Auroville Foundation, and any properties, housing / other infrastructure or commercial enterprises are ‘donated’ to Auroville and managed in trust by stewards. As a consequence, there is no legal inheritance of assets. Practically, properties, assets and profits are managed through a mix of communal and individual arrangements, trusts, units and working groups., as we discuss in Part III.F.

This arrangement reflects, in its ideal, a transcendence of individual possession, ownership and capital accumulation and a voluntary offering of all one possesses or creates to the Divine. As Sri Aurobindo notes:

You must neither turn with an ascetic shrinking from the money power [expanded here to all forms of wealth, property, profit etc.], the means it gives and the objects it brings, nor cherish a rajasic attachment to them or a spirit of enslaving self-indulgence in their gratifications. Regard wealth simply as a power to be won back for the Mother and placed at her service.²²¹

Mother’s ideal marks a novel addition to the long-standing and intractable debate on the justifications for a right to private property or collective ownership. As the noted philosopher, Waldron, says in his detailed review, the question is simple:

What individual interests are served by the existence of private property as opposed to some other sort of property regime (such as communism)? Are any of these interests so important from the moral point of view that they justify holding governments [or the collective, represented in the Auroville Foundation, in this case] to be under a duty to promote, uphold, and protect property-owning? Or is it rather the case that, taken one by one, the interests which individuals have in the matter do not have this level of importance, and these interests should be dealt with in the

²¹⁹ We were often met with the use of the term ‘mainstream’ and ‘alternate’ in Auroville. While useful, it was often caricatured and led in our conversations to a reluctance to look outside for expertise or new developments. This is an unhealthy poise. We consider this briefly in Part IV.E.

²²⁰ See, for example, Skidelsky, 2020.

²²¹ Sri Aurobindo, CWSA, 1997, Vol. 32, 10.

aggregate, in the form of utilitarian arguments about property institutions, rather than treated as rights?²²²

The answers to these questions are complex and varied. Very roughly, one may trace them to five bases:

- i. the labour theory of acquisition: that which one has developed or created by individual labour and exertion belongs to one.
- ii. first occupancy: that which one has possessed first belongs to one.
- iii. the *laissez-faire*, libertarian approach: property as an extension of the self, held absolutely.
- iv. the ethical approach: property-owning leads to ethical development and inculcation of responsibility)
- v. utilitarian: an efficient system of allocation of capital to those with greater capacity to manage the property to devise appropriate incentives.

Mixed in with these are concerns of equitable distribution, capital accumulation, historical rebalancing of entrenched inequalities, among others. By comparison, Mother's ideal outlines a Divine ownership – true at the spiritual level, in Sri Aurobindo's panentheistic scheme of things where the Divine *is* all –, with individual stewardship to manifest that underlying truth. It has hints of each of the bases above, except the *laissez-faire* approach of egoistic ownership which it rejects. It is in working out means to correspond the inner truth to the outer legal and regulatory form where the challenges arise. This presents a rich field for comparative research in Auroville.

This model of 'decentralized Divine ownership', if we may call it that, stands in contrast to historical forms of Divine ownership that locate an individual or entity as possessed of the Divine right.²²³ It requires each individual to labour and create or hold property, accumulate assets and profits yet without a sense of possession, offering all to the Divine in the disinterested spirit of renunciation in *karma yoga*: *karmanṃ-evādhikāras te mā phaleṣhu kadāchana*, 'you have a right to perform your prescribed duties, but you are not entitled to the fruits of your actions'.²²⁴ An ideal Auroville resident is a transparent instrument, not the doer, possessor or owner.²²⁵ Sri Aurobindo's translation of the paradoxical verse in *Isha Upanishad*, enjoining each to enjoy all by renouncing all, provides the spiritual foundation of this ideal:

All this is for habitation by the Lord, whatsoever is individual universe of movement in the universal motion. By that renounced thou shouldst enjoy; lust not after any man's possession.²²⁶

²²² Waldron, 1990, 3.

²²³ See, for example, for a historical review of this idea in India's political history, Varma, 1974.

²²⁴ Bhagavad Gita, (Mukundananda, transl.), 2019, 2.47. For Sri Aurobindo's commentary, see, CWSA, 1997, Vol. 19, 303-4, 458.

²²⁵ The practical stages of this easily stated, yet supremely difficult to practice, ideal are detailed in Sri Aurobindo, Mother, 12-13.

²²⁶ Sri Aurobindo, CWSA, 1997, Vol. 17, 5, with the associated commentary on this verse at 16-20.

Easily stated as a spiritual truth and moral precept, this is a radically difficult idea to practice. Naturally, this surrender cannot be expected to be entire from the beginning, and a *de facto* sense of *rajasic* ownership and possession is likely and expected (as several conversants noted is the case, and the records demonstrate).²²⁷ The work required to translate this ideal is still nascent in Auroville, and one that will become all the more challenging and exciting as population numbers and densities grow. As Mother notes, the practical details of the organization of this ideal are where the challenge lies: what does the idea of Divine ownership mean? Can individual stewards use, modify and alter the property exclusively? Are profits, entirely or partially, to be kept with the individual or enterprise for growth, reinvestment, legitimate personal use or given to the collective? If offered, who manages collective assets? How are they chosen, and what are the principles of collective management? In cases of conflict between individuals, or between the individual and the collective, how does one decide absent authority? Can residents exit Auroville with a whole or portion of lands or assets developed by their labour? Are assets, including housing, developed through individual moneys brought into Auroville from elsewhere, all part of the collective? Must offering be entirely voluntary, or can it be enforced (the rate of 33% contribution in the Code of Conduct, for example)? How does one deal with free-riders? As we discuss in Part III.E, these questions have occupied centre stage in the evolution of Auroville's economic set up (in Pour Tous, Circles, Nandini, Envelopes, Central Fund, and more recently, policies of the Finance and Asset Management and Budget Coordination Committees, with the 2002 Code of Conduct),²²⁸ and will continue to do so as the economic setup matures, with a tension between centralized planning and enterprise freedom, voluntary and flat contributions, capital formation and the ideal of a no-money economy, productivity increases and inequalities in individual holdings, a self-sustaining and porous economy etc.

Practically speaking, communal regulation usually translates into a transfer of power to a minority that runs the collective.²²⁹ Unless that minority is illumined, there is a risk of social networks dictating allocation of resources, with (perhaps veiled) negotiations over power in the collective. Alternatively, individual stewardship, absent communal regulation, usually risks inequality and concentrations of wealth or power. Legally, property belongs to the Auroville Foundation; yet the Auroville Foundation, and its offer-bearers, Working Groups etc., just as individuals, are stewards, none with an exclusive claim in Mother's scheme. Mother anticipates these challenges throughout her early comments; for example, she notes:

From this point of view, take money, for example. An ideal which may be several hundred years ahead of its time, we don't know: money should be a power which belongs to nobody and which should be controlled by the most universal wisdom

²²⁷ This is reflected, for example, in the strongly worded assessment of Lt. Governor Soundaraja, ex-member of the Governing Board ('Although Auroville has always been envisaged as a city that is meant to exist without personal property, certain residents have grown attached to their work, environment ... This has gradually resulted in a landlord-like attitude and collective work has been made to run like personal businesses and is passed on as inheritances') *The Hindu*, 2022. A certain *rajasic* attachment is indeed expected and natural and a challenge to be progressively overcome in the yoga.

²²⁸ See, for example, Thomas, 1997; Guigan, 1997; Aggarwal, 1997; for a narrative summary, see Thomas and Thomas, 2013, 126-135.

²²⁹ Sri Aurobindo, CWSA, 1997, Vol. 25, 200-7, 445-450.

present. Put on the earth someone who has a vision vast enough to be able to know the needs of the earth and precise enough to be able to tell where the money should go – you understand, we are very far from that, aren't we? For the moment, the gentleman still says, 'This is mine', and when he is generous, he says, 'I give it to you'. That's not it. But there is a long way to go between what we are and what must be.²³⁰

The practical working of this model depends on the specifications and conventions by which stewardship is regulated, and faces substantial challenges in its working out. A comparative survey with the rich, complex and long-standing literature on this subject is important to ground the experiment in past and present learnings from elsewhere, again an area that requires a strong tertiary research sector embedded into the practical workings of the city. To say 'the Divine owns everything' is true, but to translate this into practice is difficult: (i) for individual residents to offer everything to the collective requires great trust in the management of that collective by those in-charge, and (ii) for the collective management to avoid centralized inefficiencies that hinder entrepreneurial activity, trust must be placed in each resident to manage and develop properties, assets and profits. This requires cooperation, goodwill and trust, on one hand, and technical expertise in economics, management, skill-development on the other. Each of these issues have naturally been vocalized in Auroville's community dialogue, as no off-the-shelf solutions are available to translate Mother's ideal. It carries the seeds for a novel and exciting experiment in ownership schemes.

v. *Service-Based Governance, Illumined Hierarchies and Qualified Democracy*

Mother anticipated a service-based governance model with natural hierarchies of competence, rather than status-based hierarchies, monetary or otherwise. In the allocation of responsibilities, cast as voluntary duties rather than as rights, Mother provides the following guidance:

... intellectual, moral and spiritual superiority would be expressed in the general organisation not by an increase in the pleasures and powers of life but by increased duties and responsibilities.

In this place, titles and positions would be replaced by opportunities to serve and organise; the bodily needs of each one would be equally provided for.²³¹

Positions of authority, necessary for the organization of a collective *even* in an anarchist setup (a point of importance in Auroville's context, as we discuss in Part III), are to be distributed based on the capacity to serve – defined as a combination of technical expertise and state of consciousness –, rather than as entitlements to power in the name of participatory governance. Mother makes this explicit in the following exchange, in the related context of distribution of work in the Ashram:

I do not give positions to the sadhaks — I give them work; and to all I give an equal opportunity. It is those who prove to be most capable and most sincere, honest and faithful that have the biggest amount of work and the greatest responsibility.

²³⁰ Guigan, 2018, Vol. 2, 71.

²³¹ Mother, 1954.

It is by the efficiency and the quality of the work that I will judge the workers.

Never forget that here it is for the perfection of the work that we are striving, not for the satisfaction of the ego.

In the actualities of life the power of a man does not depend on an official title, but on the force and the light of his inner consciousness.²³²

This marks an important ideal – a shift from interest-based governance, responding to the natural *rajasic* human instinct for expansion, possession and domination, with lobbies and group formations in tow, to one based on enlightened duty and service. This call in itself is an old ideal, but what is new is a shift from a rational to supra-rational enlightenment, backed by a defined form of practice to get the community there. This three step-progression is considered in detail in Chapter XXI of the *Life Divine* – from self-preservation, expansion and domination (leading to power-enforced hierarchies) to mutuality and reciprocal interchange (an ordered conflict) and finally love (a spontaneous brotherhood, where Mother’s ‘dream’ of a life of emulation and collaboration rather than conflict and envy manifests). We do not have the space here to enter a detailed discussion, but it is worth quoting Sri Aurobindo’s summary of this evolutionary pattern, which provides a philosophical scheme to map the development of motivational structures in Auroville’s political economy:

We have then two principles in Life, the necessity or the will of the separate ego to survive in its distinctness and guard its identity and the compulsion imposed upon it by Nature to fuse itself with others ...

The phenomenon of hunger and desire involves a struggle towards a status of satisfaction and security, since desire is only the stimulus by which Life tempts its own positive being to rise out of the negation of unfulfilled hunger towards the full possession of the delight of existence. The phenomenon of limited capacity involves a struggle towards expansion, mastery and possession, the possession of the self and the conquest of the environment.

... the principle of co-operation and mutual help, the desire of others, the desire of the wife, the child, the friend and helper, the associated group, the practice of association, of conscious joining and interchange are the seeds out of which flowers the principle of love.

[The] last stage ... can only be reached when the two principles are harmonised, when the individual is able to persist in the consciousness of his individuality and yet fuse himself with others without disturbance of preservative equilibrium and interruption of survival ...²³³

As we noted above, the key motive-force for the development of the democratic ideal was a recognition of the essential equality of all, characteristic of the second stage in Sri Aurobindo’s evolutionary scheme. This stands in contrast to hierarchies of status dominant in the ‘conventional age,’ defining characteristics of the ‘infra-rational’ stage of development, the first stage. Yet, the shift is gradual, and these systems are liable to oligarchic capture by a minority or a tyranny of the majority. We discuss the implications of this in Part III – in relation to the

²³² Mother, CWM, 2002, Vol. 13, 160.

²³³ Sri Aurobindo, CWSA, 1997, Vols. 21-22, 211-4.

working of the Residents' Assembly, Working Groups and community participation – but a brief statement is helpful here.

On one hand, the participatory democratic may bring with it a levelling-down tendency, common to egalitarian thinking, where incompetent or un-informed voices carry equal weight as competent ones – it may, as Sri Aurobindo notes, 'cheapen thought.'²³⁴ Democratic conceptions work *if* all members are well-informed and enlightened; if not, a cacophony often results. It is in this context that Sri Aurobindo emphasizes the importance of a diffused culture of broad-based education, as a supporting base for democratic political forms:

The natural remedy for the first defects of the individualistic theory in practice would seem to be education; for if man is not by nature, we may hope at least that he can be made by education and training something like a rational being. Universal education, therefore, is the inevitable second step of the democratic movement in its attempt to rationalise human society. But a rational education means necessarily three things, first, to teach men how to observe and know rightly the facts on which they have to form a judgment; secondly, to train them to think fruitfully and soundly; thirdly, to fit them to use their knowledge and their thought effectively for their own and the common good. Capacity of observation and knowledge, capacity of intelligence and judgment, capacity of action and high character are required for the citizenship of a rational order of society; a general deficiency in any of these difficult requisites is a sure source of failure. Unfortunately, — even if we suppose that any training made available to the millions can ever be of this rare character, — the actual education given in the most advanced countries has not had the least relation to these necessities.²³⁵

As we consider in Part IV, initiatives like the Auroville Campus Initiative, Integral Education Lab, the Citizens' Assembly, Aware Auroville, Working Group updates in News and Notes, Auroville Today, exhibitions / commentaries produced by the Auroville Archives, regular Youtube updates from Office of the Secretary to the Foundation, public fora like AuroNet and others that look to generate greater awareness on matters of public concern and train the necessary skill-sets for informed, unprejudiced decision-making, are important attempts in this direction that can be strengthened and organized – in our proposal in Part III.E in a city-wide embedded digital learning platform – to generate an enlightened participation 'from below'. Absent these, a 'more democratic democracy,' the ideal of the Residents' Assembly and other collective fora runs the risk of an

... immense waste of time and energy and confused, swaying and uncertain action that 'muddles out' in the end some tolerable result.²³⁶

On the other hand, the concentration of decision-making powers in a technocratic body, which may be more efficient and ordered, carries the risk of translating conventional social hierarchies into bureaucratic forms. As Sri Aurobindo notes:

²³⁴ Sri Aurobindo, CWSA, 1997, Vol. 25, 90. Mother's exchange in the *Agenda* on this makes for interesting reading: 'Satprem: In democracies and with the Communists, there's a levelling down: everyone is pulled down to the same level. Mother: Yes, that's just the point.' Guigan, 2018, Vol. 1, 226.

²³⁵ Sri Aurobindo, CWSA, 1997, Vol. 25, 198.

²³⁶ Sri Aurobindo, CWSA, 1997, Vol. 25, 473.

... instead of the Brahmin Shastrakara the scientific, administrative and economic expert ... Instead of a hierarchical arrangement of classes each with its powers, privileges and duties there will be established an initial equality of education and opportunity, ultimately perhaps with a subsequent determination of function by experts who shall know us better than ourselves and choose for us our work and quality. In the place of the King himself ... there will stand the collectivist State similarly guided and empowered.²³⁷

This is a marked tension that manifests itself in Auroville today, between the Working Groups and the community, the perceived technocratic ‘elite’ and the *demos*, often leading to a decision-making paralysis. This is reflected, for example, in points 6 and 16-19 of the ‘elephants in the room’ in the Full Report of the 2015 Auroville Retreat, which we discuss in the context of current governance practices in Part IV.²³⁸

Sri Aurobindo and Mother resolve this tension by pointing to a form of government that balances the twin interests of equality and liberty, of participation and technocratic competence: that of an *illuminated hierarchy*, backed by a collective discipline born of trust. Mother notes:

[Q. What should be the nature of this organization, in the present and in the future?]

A. Organization is the discipline of action, but for Auroville, we aspire to go beyond arbitrary and artificial organizations. We want an organization which is the expression of a higher consciousness working to manifest the truth of the future.

[Q. Until this group consciousness appears, and until we can work collectively in the true and right way, what should we do?]

A. A hierarchical organization grouped around the most enlightened centre and obeying a collective discipline.²³⁹

Mother’s antidote to participatory disorder, all ruling all turning into none ruling effectively (a complaint often made by Working Groups) and technocratic capture (a complaint often made against Working Groups) is a ‘hierarchic organisation grouped around the most enlightened centre and submitting to a collective discipline’ – an essential equality of all does not translate *ipso facto* into a functional equality in matters of decision-making. This distinction between natural – illumined or competence-based – hierarchies, rather than status or entitlement-based ones, is central to the organization of Auroville’s collective decision-making processes, in its anarchist aspirations, such that participatory models of governance – with each resident having a voice, but perhaps not a vote – operate in tandem with a hierarchical authority comprising those of an ‘illuminated will ... and [an] unerring leadership.’ The ‘evil’ of democracy, a ‘decline in greatness’ in the name of equality, is thus sought to be avoided.²⁴⁰

²³⁷ Sri Aurobindo, CWSA, 1997, Vol. 25, 22.

²³⁸ Full Report, Auroville Retreat, 2015, Annexure 5, 64-5, 67.

²³⁹ Guigan, 2018, Vol. 1, 327-8. This is an old ideal. *See*, for example, Plato’s famous discussion on this point, summarized in Lange, 1939; Kraut, 2018; for a review of modern literature, *see*, Berstou and Caramani, 2020. This is an important and under-researched area in Auroville, to inform its political practices from lessons elsewhere.

²⁴⁰ Sri Aurobindo, CWSA, 1997, Vol. 12, 467.

Whilst Mother's view is not incompatible with majority decision-making processes aspiring to consensus, it does not lean in that direction. In this passage, absent consensus, aggregative preferences represented by a majority vote, the democratic route, are substituted by a submission to the 'most enlightened centre' available at the time, albeit imperfect. This is an important shift, both in philosophical and practical terms. Her view invites strong participation, a valid democratic, egalitarian imperative, yet she advocates the legitimate authority of an illumined minority in decision-making when disagreements arise. As with many before, she was a qualified votary of democratic processes.²⁴¹ As indeed of assemblies:

Because men still imagine that in order to do anything useful, they must gather together in groups. It is the caricature of organisation.²⁴²

While none can replace Mother's leadership (really speaking, the nub of all governance problems in Auroville), the collective organized along illumined hierarchies can aspire to it. This is naturally easier said than done: (i) locating these illumined individuals may be difficult as an epistemic matter, even if impartiality and goodwill are assumed, or (ii) as a practical matter, it may result in residents picking such experts / illumined individuals on interest-based preferences, thus not solving the problem but introducing another one, that of representative capture. Appropriate organizational choices have thus to be made in Auroville responsive to this dynamic. We consider this in Part IV in light of past practices of the Residents' Assembly and Working Groups.

A floor-level egalitarianism, if we may call it that, to accord equal concern and respect to all, in material and social terms, across the board is consistent with a hierarchy of powers to some for their domains of expertise. This hierarchy follows the development of *capacities*, particularly the state of illumination of consciousness, and does not level down participatory rights to dictate collective movement, with its inevitable interest-based pulls and pushes, to all. Ideally, Mother envisages a dual movement: the collective discipline of all recognizes the authority of the illumined in their field, and the illumined serve the collective regardless of their own preferences.

Indeed, the reason for Sri Aurobindo and Mother's constant emphasis on brotherhood and unity as the cement on which polities effectively organize is manifest here: it serves to counteract on one hand the natural tendencies to envy (a common criticism of egalitarian systems) and on the other, competition to vie for power or impose preferences on the collective, even if well-intentioned (a common criticism of liberal systems). Concluding his discussion in the *Human Cycle*, Sri Aurobindo points to the future along these lines:

But if both equality and liberty disappear from the human scene, there is left only one member of the democratic trinity, brotherhood or, as it is now called, comradeship, that has some chance of survival as part of the social basis. ...

Yet is brotherhood the real key to the triple gospel of the idea of humanity. The union of liberty and equality can only be achieved by the power of human brotherhood and it cannot be founded on anything else. But brotherhood exists only in the soul and by

²⁴¹ We discuss this in Part IV.B in relation to the place and limit of the Residents' Assembly.

²⁴² Guigan, 2018, Vol. 1, 215.

the soul; it can exist by nothing else. For this brotherhood is not a matter either of physical kinship or of vital association or of intellectual agreement.

A deeper brotherhood, a yet unfound law of love is the only sure foundation possible for a perfect social evolution, no other can replace it. But this brotherhood and love will not proceed by the vital instincts or the reason where they can be met, baffled or deflected by opposite reasonings and other discordant instincts. Nor will it found itself in the natural heart of man where there are plenty of other passions to combat it. It is in the soul that it must find its roots; the love which is founded upon a deeper truth of our being, the brotherhood or, let us say, for this is another feeling than any vital or mental sense of brotherhood, a calmer more durable motive-force, the spiritual comradeship which is the expression of an inner realisation of oneness. For so only can egoism disappear and the true individualism of the unique godhead in each man found itself on the true communism of the equal godhead in the race; for the Spirit, the inmost self, the universal Godhead in every being is that whose very nature of diverse oneness it is to realise the perfection of its individual life and nature in the existence of all, in the universal life and nature.²⁴³

Thus, Auroville's ideal is to perfect the democratic form, leading to the nebulous (because ineffable) state of Divine anarchy, with the principle of illumined hierarchies as the interim vehicle. This is to be done by the combination of an assembly (with qualified majoritarian practices) and a system of efficient administration – a separation of legislative and executive powers – on the principle of enlightened hierarchies with (as far as possible, voluntary) collective discipline. In doing so, Mother and Sri Aurobindo's careful detailing of the practical path to spiritual anarchism looks to progressively dent the standard problems attendant to such utopian projects – disorder, instability, abstract 'toothless' ideal theory divorced from practice, self-defeating incoherence.²⁴⁴ The difficult, and yet unsolved, problem to be worked out in Auroville – a 'great task', in Mother's words – is to translate the ideal of spiritual anarchism, through progressively illumined democratic forms, into the daily rhythms of collective life:

What is the use of only knowing? I say to thee, Act and be, for therefore God sent thee into this human body.²⁴⁵

But even when they see it, they have no power to enforce it. So between blind power and seeing impotence the world moves, achieving destiny through a mental muddle.²⁴⁶

As we propose in Part IV, this needs to be translated into clearly defined processes for the working of the Residents' Assembly and selection of Working Groups, with (i) a bicameral, representative and federated restructuring of the Residents' Assembly, with (ii) rules for ordered and informed deliberation and (iii) a restructuring of Working Group selection, execution and monitoring processes. Proposals, variously worded but common in substance, for a 'Unity Committee', 'Dynamic Residents' Assembly', 'Active Residents' Assembly', 'Functional Residents' Assembly', 'Council of the Wise', 'City Council', 'Council of Sages', 'Steering Group', 'Supreme Council', 'Vision Task Force', 'Citizens' Assembly' etc. –

²⁴³ Sri Aurobindo, CWSA, 1997, Vol. 25, 203-4.

²⁴⁴ See, for an overview of standard objections and replies, Fiala, 2021, Section 4.

²⁴⁵ Sri Aurobindo, CWSA, 1997, Vol. 12, 471.

²⁴⁶ Sri Aurobindo (eds., Nahar et. al.), 2003, 32.

discussed at several points since 1999, but not implemented – are efforts in this direction to streamline collective decision-making processes that merit attention.

*

E. A COMMITMENT TO RESEARCH, INNOVATION AND FREE PROGRESS EDUCATION

Education, understood not simply in its formal sense, but as a complement to life in the movement from *avidya*, Ignorance to *vidya*, Knowledge, was central to Sri Aurobindo and Mother's life and works. This vision – the growth of the 'sleepless Flame' of the spirit – occupies prime place in Auroville's charter: 'Auroville will be the place of an unending education, of constant progress, and a youth that never ages.' In a sense, the first and last marker of education in Auroville is the move to spiritual experience, a progressive knowledge by identity of the inner parts of one's being. This supra-rational search for knowledge, in and through life, is the path of the Integral Yoga. 'Ultimately', said Mother, Auroville 'must be a town for studies – studies and research on how to live both in a simplified way and in a way such that the higher qualities have more time to develop'.²⁴⁷

This yields a singularly important pillar of Auroville's founding ideal, indeed one that envelops all the rest: a city dedicated to research across disciplines and orientations, cultures and languages, within and without. In Mother's ideal, Auroville was a confluence, a *sangama* of all streams of knowledge mingling in its rich and diverse atmosphere, a 'brilliant passage for the infallible Flame',²⁴⁸ pushing forward to future realizations:

Auroville wants to be the bridge between the past and the future. Taking advantage of all discoveries ... All discoveries, you know: philosophical, spiritual, moral, scientific, all – taking advantage of the past ... of all discoveries from without and from within, it wants to boldly spring towards future realisations.²⁴⁹

The constitutional imprint of this seeking orientation is the driving force to all sectors of life in Auroville, from the sublime to the instrumental, the Divine and human, the arts to the sciences, commerce to politics, from food production to waste management. A city dedicated to this ideal, indeed consecrated so with the living presence of the Matrimandir, is pregnant with potential for an innovation-driven research infrastructure supported by forms of community living that act as a playground for discovery. The Charter proclaims:

Auroville will be a site of material and spiritual researches for a living embodiment of an actual human unity.²⁵⁰

Casting his glance forward, Sri Aurobindo's words are a commentary on Mother's Charter:

The thing to be done is as large as human life, and therefore the individuals who lead the way will take all human life for their province. These pioneers will consider nothing as alien to them, nothing as outside their scope. For every part of human life has to be taken up by the spiritual, not only the intellectual, the aesthetic, the ethical, but the dynamic, the vital, the physical; therefore for none of these things or the activities that spring from them will they have contempt or aversion, however they may insist on a change of the spirit and a transmutation of the form.

²⁴⁷ Guigan, 2018, Vol. 1, 29.

²⁴⁸ Sri Aurobindo, CWSA, 1997, Vols. 33-4, 108.

²⁴⁹ Guigan, 2018, Vol. 1, 241.

²⁵⁰ Guigan, 2018, Vol. 1, 256.

A revolutionary reconstruction of religion, philosophy, science, art and society is the last inevitable outcome.²⁵¹

The reach of this ideal is, in the final analysis, infinite. Writing in the backdrop of the triumph of science, albeit in its warring avatar, the placement of Auroville as a meeting point of the two seemingly irreconcilable streams of human exploration, Mother envisioned the city as a site for tertiary or advanced research not only the spiritual but the temporal disciplines. Science, technology, commerce, politics too are cast within Auroville's net as part of its integral and life-affirming orientation. Speaking of the future of science and spirituality, Sri Aurobindo writes, for example, of the 'remarkable and suggestive' discoveries, now pushed even farther, that Auroville is to ground to 'reveal the full significance' of each:

Not only in the one final conception, but in the great line of its general results Knowledge, by whatever path it is followed, tends to become one. Nothing can be more remarkable and suggestive than the extent to which modern Science confirms in the domain of Matter the conceptions and even the very formulae of language which were arrived at, by a very different method, in the Vedanta... And these, on the other hand, often reveal their full significance, their richer contents only when they are viewed in the new light shed by the discoveries of modern Science, — for instance, that Vedantic expression which describes things in the Cosmos as one seed arranged by the universal Energy in multitudinous forms.²⁵²

Synthesizing the 'denial of the ascetic' and the 'refusal of the materialist', in its fundamental and applied forms, Auroville was founded as open to all streams of knowledge – no seeking orientation was rejected, all was welcome. This attitude of openness and syncretic assimilation is, as he notes, the 'true sense and spirit' of Indian culture, a microcosm of the world, as is Auroville in Mother's founding vision.²⁵³ Sri Aurobindo's description of this spirit yields an exquisite research agenda for Auroville:

... she has been creating abundantly and incessantly, lavishly, with an inexhaustible many-sidedness ... philosophies and cosmogonies and sciences and creeds and arts and poems and all kinds of monuments, palaces and temples and public works, communities and societies and religious orders, laws and codes and rituals, physical sciences, psychic sciences, systems of Yoga, systems of politics and administration, arts spiritual, arts worldly, trades, industries, fine crafts, — the list is endless and in each item there is almost a plethora of activity. She creates and creates and is not satisfied and is not tired; she will not have an end of it, seems hardly to need a space for rest, a time for inertia and lying fallow.²⁵⁴

Nor does this endeavour exclude the intellectually oriented disciplines of the modern age, a pointer for Auroville's research future:

For the third power of the ancient Indian spirit was a strong intellectuality, at once austere and rich, robust and minute, powerful and delicate, massive in principle and curious in detail. Its chief impulse was that of order and arrangement, but an order

²⁵¹ Sri Aurobindo, CWSA, 1997, Vol. 25, 226, 28.

²⁵² Sri Aurobindo, CWSA, 1997, Vols. 21-2, 16.

²⁵³ We discuss Mother's views on India and Auroville as concentrated microcosm in Part II.

²⁵⁴ Sri Aurobindo, CWSA, 1997, Vol. 20, 7-8.

founded upon a seeking for the inner law and truth of things and having in view always the possibility of conscientious practice ...

Nor was all this colossal literature confined to philosophy and theology, religion and Yoga, logic and rhetoric and grammar and linguistics, poetry and drama, medicine and astronomy and the sciences; it embraced all life, politics and society, all the arts from painting to dancing, all the sixty-four accomplishments, everything then known that could be useful to life or interesting to the mind, even, for instance, to such practical side minutiae as the breeding and training of horses and elephants, each of which had its Shastra and its art, its apparatus of technical terms, its copious literature. In each subject from the largest and most momentous to the smallest and most trivial there was expended the same all-embracing, opulent, minute and thorough intellectuality. On one side there is an insatiable curiosity, the desire of life to know itself in every detail, on the other a spirit of organisation and scrupulous order, the desire of the mind to tread through life with a harmonised knowledge and in the right rhythm and measure. Thus an ingrained and dominant spirituality, an inexhaustible vital creativeness and gust of life and, mediating between them, a powerful, penetrating and scrupulous intelligence combined of the rational, ethical and aesthetic mind each at a high intensity of action, created the harmony of the ancient Indian culture.²⁵⁵

Mother's terse encapsulation of Auroville's research aspirations in the Charter thus carries a world of possibilities, indeed an *imperative* of exploration across disciplines, assimilating the vast labours and learnings of past traditions as a step, indeed a necessary one, to future realizations. The integrality of this ideal, both deep and wide, bears on Auroville's research landscape, which must be open to the outside and yet settled in its own soul, embodied in the Matrimandir. Here, Mother's casting of all activities of life into the spatial form of each zone of the city gives a *practical* orientation to the research landscape – as we suggest in Part III.D, the institution of a multi-disciplinary free-progress research university *embedded* into each sector of activity in the city across disciplines of knowledge offers one way to secure the material foundations for Auroville's future aspirations and yet unimagined possibilities in tertiary research, for it grow as Mother imagined as 'the greatest sweat of knowledge upon Earth'.²⁵⁶

Key also to this movement is Mother's reference to a '*living* embodiment of an actual human unity', a reference to the spiritual researches of the collective yoga. Auroville is here tasked with developing and practising forms of governance and collective organization that may respond to the persistent ills of our communal becoming, those of disharmony, injustice and unfreedom. Sri Aurobindo again expands on Mother's formulation to lay out what can be considered Auroville's goal, a benchmark to measure its progress, against which much is yet to be done:

A society that lives not by its men but by its institutions, is not a collective soul, but a machine; its life becomes a mechanical product and ceases to be a living growth. Therefore the coming of a spiritual age must be preceded by the appearance of an increasing number of individuals who are no longer satisfied with the normal

²⁵⁵ Sri Aurobindo, CWSA, 1997, Vol. 20, 9-10.

²⁵⁶ Guigan, 2018, Vol. 1, 45.

intellectual, vital and physical existence of man, but perceive that a greater evolution is the real goal of humanity and attempt to effect it in themselves, to lead others to it and to make it the recognised goal of the race. [The goal being] a deeper brotherhood, a yet unbound law of love.²⁵⁷

In this, the ‘schooling’ of children, was a singularly important task for Mother for the new world to be born. She emphasizes, in the Charter, Dream and On Education, the need for a progressive system of education – one that keeps alive contact with the soul, or as Sri Aurobindo encapsulated in his ‘first principle of education’, nothing can be taught from without, yet all can be learnt from within.

In this place, children would be able to grow and develop integrally without losing contact with their souls; education would be given not for passing examinations or obtaining certificates and posts but to enrich existing faculties and bring forth new ones.²⁵⁸

Mother here was responding to the instrumentalization of education to commercial ends, a substitution of the joy of learning natural to children for the enforced drain of securing narrowly defined metrics of success. Sri Aurobindo notes the contrast between the two and the changing tides of the time in which Auroville was found, pointing to future work that remains to be done:

Behind it all the hope of the race lies in those infant and as yet subordinate tendencies which carry in them the seed of a new subjective and psychic dealing of man with his own being, with his fellow-men and with the ordering of his individual and social life. The characteristic note of these tendencies may be seen in the new ideas about the education and upbringing of the child that became strongly current in the pre-war era. Formerly, education was merely a mechanical forcing of the child’s nature into arbitrary grooves of training and knowledge in which his individual subjectivity was the last thing considered, and his family upbringing was a constant repression and compulsory shaping of his habits, his thoughts, his character into the mould fixed for them by the conventional ideas or individual interests and ideals of the teachers and parents. The discovery that education must be a bringing out of the child’s own intellectual and moral capacities to their highest possible value and must be based on the psychology of the child-nature was a step forward towards a more healthy because a more subjective system; but it still fell short because it still regarded him as an object to be handled and moulded by the teacher, to be educated. But at least there was a glimmering of the realisation that each human being is a self-developing soul and that the business of both parent and teacher is to enable and to help the child to educate himself, to develop his own intellectual, moral, aesthetic and practical capacities and to grow freely as an organic being, not to be kneaded and pressured into form like an inert plastic material. It is not yet realised what this soul is or that the true secret, whether with child or man, is to help him to find his deeper self, the real psychic entity within. That, if we ever give it a chance to come forward, and still more if we call it into the foreground as ‘the leader of the march set in our front’, will itself take up most of the business of education out of our hands and develop the capacity of the psychological being towards a realisation of its potentialities of which our present mechanical view of life and man and external routine methods of dealing

²⁵⁷ Sri Aurobindo, CWSA, Vol. 25, 263, 220.

²⁵⁸ Mother, 1954.

with them prevent us from having any experience or forming any conception. These new educational methods are on the straight way to this truer dealing.²⁵⁹

Auroville is thus tasked with the development and propagation of these ‘new educational methods.’ One manifestation of it – the ‘free progress’ system, detailed in Mother’s ‘On Education’ and Sri Aurobindo’s ‘System for National Education,’ and practiced in their lifetimes in the Sri Aurobindo International Centre of Education – provides the foundations for this work.²⁶⁰ It bears noting here that the call to the future that Sri Aurobindo outlined is also a call back to the eternal traditions of the past. Looking at the civilizational exploits of India, he asks, for example:

What was the secret of that gigantic intellectuality, spirituality and superhuman moral force which we see pulsating in the Ramayana and Mahabharata, in the ancient philosophy, in the supreme poetry, art, sculpture and architecture of India? What was at the basis of the incomparable public works and engineering achievements, the opulent and exquisite industries, the great triumphs of science, scholarship, jurisprudence, logic, metaphysics, the unique social structure? What supported the heroism and self-abandonment of the Kshatriya [warrior], the Sikh and the Rajput, the unconquerable national vitality and endurance? What was it that stood behind that civilisation second to none in the massiveness of its outlines or the perfection of its details? Without a great and unique discipline involving a perfect education of soul and mind, a result so immense and persistent would have been impossible. It would be an error to look for the secret of Aryan success in the details of the instruction given in the old ashrams and universities so far as they have come down to us. We must know what was the principle and basis on which the details were founded. We shall find the secret of their success in a profound knowledge of human psychology and its subtle application to the methods of intellectual training and instruction.²⁶¹

The marriage of the psychological insights of the educational disciplines of the past to the vistas of exploration opened up in the modern age was his ideal, as indeed that of the Mother in her ‘On Education’, the work to be accomplished in the fulness of its details in Auroville:

It is not our contention that the actual system of ancient instruction should be restored in its outward features, — a demand often made by fervid lovers of the past. Many of them are not suited to modern requirements. But its fundamental principles are for all time and its discipline can only be replaced by the discovery of a still more effective discipline, such as European education does not offer us. The object of these articles has been to indicate the nature and psychological ideas of the old system and point out its essential relation of cause and effect to the splendid achievement of our ancestors. How its principles can be reapplied or be completed and to some extent replaced by a still deeper psychology and a still more effective discipline is a subject fit for separate treatment.²⁶²

²⁵⁹ Sri Aurobindo, CWSA, Vol. 25, 263, 32.

²⁶⁰ As the literature on the free progress method has been discussed elsewhere, we will limit our discussion here. Mother, CWM, 2002, Vol. 12, contains a series of six essays outlining the core principles. For expositions, *see*, Joshi, 1999a; Partho, 2021.

²⁶¹ Sri Aurobindo, CWSA, 1997, Vol. 1, 369.

²⁶² Sri Aurobindo, CWSA, 1997, Vol. 1, 378.

A survey of Mother and Sri Aurobindo's educational thought, or the possibilities of its varied manifestation in Auroville, is beyond our scope.²⁶³ Briefly, Auroville, in Mother's ideal, is a site for concentrated experimentation on the free progress method, across age-groups and disciplines of learning, cross-fertilization with other systems of progressive education in a spirit of collaborative exchange and importantly, research documentation and sharing, to build a body of pedagogical and psychological knowledge that may sustain the educational future of the coming generations. This is both for Auroville's youth – building of the next generation that can secure its ideals, in governance and elsewhere – and as an alternate to existing Boards of Education to serve India and the world. The flowering of the new consciousness begins at an early age, and as such, the Auroville school – or more appropriately in Sanskrit *vidyālaya*, a place to discover 'the Knowledge of Oneness' – is ground zero, the foundation on which the edifice of Auroville's future aspiration rests.²⁶⁴

*

²⁶³ See, for a perceptive essay on schooling in Auroville, Tiwari, 2002. See also, Sri Aurobindo Institute of International Education Research, 2018 for short, insightful reflections by teachers in Auroville schools.

²⁶⁴ Sri Aurobindo, CWSA, 1997, Vols. 21-22, 39. In a beautiful remark in the *Agenda*, Mother notes that 'almost all' children born in Auroville at the time were souls with a conscious being, having chosen this environment for spiritual growth. Guigan, 2018, Vol. 2, 184.

PART II THE VISION OF THE CITY

A Form from far beatitudes seemed to near.

Sri Aurobindo, *Savitri*

This Part outlines Mother's account of spiritual urbanism to suggest that the urban environment provides an evolutionary spatial form in which the concentrated evolution, leading to the emergence of a gnostic society, occurs: developing a spiritual 'city' or township, therefore, is part of the material *raison d'être* of Auroville and not simply a coincidental, or supplementary, occurrence. **Section A** discusses Mother's spatial arrangement of the city and early conceptualization. **Section B** outlines the history of the Galaxy concept and its relevance to Auroville today. **Section C** relates Mother's vision of Auroville as 'the city the Earth needs' and Sri Aurobindo's views on 'the advent and progress of the spiritual age' to contemporary problems of urbanism, against the background of the Perspective Masterplan 2025. It outlines Auroville's aspirations to a 'spiritual urbanism'. **Section D** reflects, in this light, on two 'elephants in the room,' namely the city-versus-consciousness and organic-versus-planned development debates. **Section E** sets the stage for Part II, which considers Auroville's empirical development across eight sectors as against the vision.

A. THE QUARTET-CITY SKETCH AND CITY CONCEPT

Mother gave a material manifestation to these four principles in the quartet-city, translated into a conceptual design – the Galaxy – by her primary instrument for the purpose, Roger Anger. As there exists a body of literature discussing Mother’s plan, we provide a succinct brief of the early conceptualization.

i. *The Constituent Zones*

In Mother’s design, the city has four zones representing the four Powers of the Supreme Mother, or the creative Force of the Divine, each centripetally represented in the Matrimandir, the soul of the city, and a surrounding Park of Unity. These are the Industrial Zone (*mahakali*), Residential Zone (*maheshwari*), Cultural Zone (*mahalakshmi*) and International Zone (*mahasaraswati*). These zones are surrounded by a Green Belt and between them lie four ‘intermediary zones.’ We lay out Mother’s vision for each zone in this section, and consider their progress across the seven sectors in Part III.

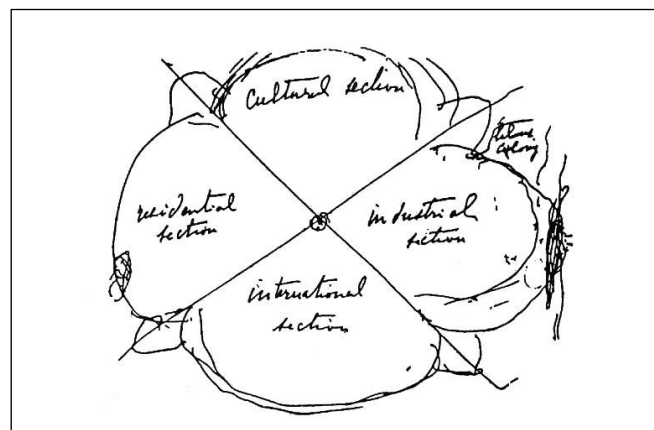

(Early sketch of the city plan, dated June 23, 1965. *Source*: Guigan, 2018, Vol. 1, 102)

The Industrial Zone is to develop an economically self-sustaining township, with ‘big factories, godowns, stores and sheds ... to export goods.’ It is to comprise small scale industries and large-scale manufacturing. This zone represents the force of strength, and is meant to actualize the principles of productive life outlined in Part I.B. She detailed the Industrial Zone further into five sectors as follows:

There will be five Industrial zones. Some are on the sea-side where the big factories, godowns, stores and sheds, will be built to export goods. [NR] Small scale industries like handicrafts, bakeries, potteries and other workshops will be built for things of immediate need. Also there will be showrooms, manufacturing and displaying things and guiding people where things can be obtained and bought. Also there will be schools to learn handicrafts, offices, and this zone will be surrounded by trees and gardens.¹

[Elsewhere, She mentions:]

¹ Guigan, 2018, Vol. 2, 244-45.

So right at the very end, in Indian territory, in Madras State, we'll have a large ceramics industry. On the other side, we'll have a little factory for firing clay. All this is huge. A tremendous program.

So this industrial section would slope down to the sea, and, if it is possible, there would be a sort of 'landing place' (not exactly a harbour, but a place where ships can berth), and all those industries with the necessary internal means of transport would have a direct possibility of export. And here, there would be a big hotel ... to receive visitors from outside.²

It won't be a 'harbour', but anyway. Yes, the hotel for visitors with a yacht club next to it ...³

Technological advances of the second half of the 20th century – in communications, computing, manufacturing, automation, services, energy and allied fields – had not yet occurred at scale, and naturally economic opportunities and systems today open different avenues from what were available at the time. The underlying import of Mother's vision, however, is clear: a surplus generating commercial setup, rich and abundant yet not excessive, contributing to the township either through goods and services or in case of exports or sales outside Auroville, through money. This is an area in which Auroville has far to go. As we discuss in Part III.F, it is an important and yet undecided question as to what Auroville's economic profile in the Industrial Zone will look like.

The Residential Zone is 'for people who wish to stay in a collectivity, that is to say as neighbours.'⁴ It comprises 'independent houses with gardens', higher-density collective housing and other forms suited to purpose, old age homes, 'management houses' with facilities etc.⁵ This zone represents the force of Wisdom, and is meant to actualize the principles of progressive fraternity in close quarters, achieving high-living standards with 'full creature comforts and conveniences,' a refined aesthetic sense and communal warmth in density – a marriage of form and function as a response to the problems of urbanism discussed below, i.e., alienation, sprawl, ugliness etc.⁶ As Mother noted, houses were to be of various types, apartments, individual dwelling units, both low and high-rise – 'I am in favour of some diversity in the types, in accordance with the types of residents' – with the *mantra*: 'Beauty in simplicity – comfortable but without luxury for luxury, harmony in usefulness.'⁷

The Cultural Zone is to host cultural activities, ranging broadly from the arts and sciences to other disciplines of human endeavour. It represents the force of harmony and is meant to actualize the spiritual ideal of the Integral Yoga, in arts and aesthetics, research and education, providing new forms to the spirit. It comprises

... art galleries, studios, museums, exhibitions halls, an auditorium, schools, colleges and so on. Musicians, dancers, painters, sculptors and other artists will have their

² Guigan, 2018, Vol. 1, 105.

³ Guigan, 2018, Vol. 1, 113.

⁴ Guigan, 2018, Vol. 1, 245.

⁵ Guigan, 2018, Vol. 1, 245.

⁶ Guigan, 2018, Vol. 1, 207.

⁷ Guigan, 2018, Vol. 1, 123.

houses surrounded by natural beauties. The artists will be undisturbed and free to create new things.⁸

... a school of photography, television and film.⁹ ... to provide every facility to talented youth from all parts of the world particularly from India, who aspire to film careers. As the most effective means of achieving this, our program includes a comprehensive series of courses in every phase of motion picture production and management ... To provide the material setting and the inspirational atmosphere for this great venture, the plan calls for a self-contained New Horizon world extensive enough to include all the multiple activities and requirements of large-scale film production; to house all of the permanent staff, cast and other employees; to accommodate guest personnel and visitors, and to supply the entire community with food, health, educational, recreational and other essentials.¹⁰

There is also a gliding club ... It will be in the cultural section, on top of the hill.¹¹

... an auditorium (the auditorium I have dreamed of doing for a long time: plans had already been made), an auditorium with a concert hall and grand organ, the best you find now (it seems they make wonderful things). I want a grand organ. There will also be a theatre stage with wings (a revolving stage and so on, the very best you can find). So, here, a magnificent auditorium. There will be a library, there will be a museum, exhibition rooms (not in the auditorium: in addition to it), there will be a cinema studio, a cinema school; there will be 'a gliding club'.¹²

And a stadium that we want to be the most modern and the most perfect possible, with the idea (an idea I've had for a long time) that ... twelve years after 1968 ... we would have the Olympic games in India, here. So we need space.

...

The sports are planned more for a possibility of the Olympic Games than for the physical education of the children.¹³

The International Zone is to act as a symbolic microcosm of the major civilizations and cultures of the world, a concentrated experimental ground for the problems of international unity in diversity. It represents the force of perfection, and is meant to actualize Sri Aurobindo's vision for international comity in the *Ideal of Human Unity*. One may consult here Mother's conceptualization of 'An International University Centre' in the Sri Aurobindo Ashram, which was a precursor to the ideal of the International Zone. She describes it as follows:

... the cultures of the various parts of the world will be represented here so as to be accessible to all, not merely intellectually in ideas, theories, principles and language, but also vitally in habits and customs, art in all its forms—painting, sculpture, music, architecture, decoration—and physically through natural scenery, dress, games, sports, industries and food. A kind of permanent world-exhibition should be organised

⁸ Guigan, 2018, Vol. 1, 116.

⁹ Guigan, 2018, Vol. 2, 56. Mother mentions this in an earlier attempt to establish a township, but it fits in to the plan for the Cultural Zone.

¹⁰ Guigan, 2018, Vol. 2, 57-9. These are not Mother's words, but from a brochure entitled 'New Horizon International – motion pictures dedicated to a greater tomorrow', to which Mother gave her blessings.

¹¹ Guigan, 2018, Vol. 1, 113.

¹² Guigan, 2018, Vol. 1, 106.

¹³ Guigan, 2018, Vol. 1, 124.

in which all countries will be represented in a concrete and living way. The ideal would be for every nation with a well-defined culture to have a pavilion representing that culture, built in a style that is most expressive of the customs of the country; it will exhibit the nation's most representative products, natural as well as manufactured, and also the best expressions of its intellectual and artistic genius and its spiritual tendencies. Each nation would thus have a very practical and concrete interest in this cultural synthesis and could collaborate in the work by taking responsibility for the pavilion that represents it. Living accommodation, large or small according to the need, could be attached, where students of the same nationality could stay and thus enjoy the true culture of their native country and at the same time receive at the university centre the education which will introduce them to all the other cultures that exist on earth. In this way, international education will not be merely theoretical, in the classroom, but practical in all the details of life.¹⁴

Beyond the four primary zones, the four intermediary ones, intersecting the quartet, are described thus:

one [zone] for public services (the post, etc.); one zone for transportation (railway station and if possible an airfield); one zone for food supplies (that one would be near the [Osudu] lake and would include dairies, poultry farms, orchards, cultivation, etc. – it would spread to incorporate the Lake Estate [a large Ashram farm at the south end of Osudu Lake]: what they wanted to do separately will be done as part of Auroville.) Then a fourth zone (I've said: public services, transportation, food supplies) and the fourth zone: shops. We do not need many shops, but a few are necessary to get what we don't produce. They are like neighbourhoods, you see.¹⁵

... [In response to the question, 'will there be modern shops like supermarkets, where to find whatever one needs,' Mother replied] There will be a special neighbourhood reserved for shops.¹⁶

... in the Lake Estate project, there was already an airfield ... There has already been a lot of talk about this, there have been talks between Air India and another company, but then they didn't agree – all sorts of silly little difficulties. But all that will fall off naturally with Auroville's growth – people will be only too glad to have an airfield.¹⁷

Finally, the Green Belt surrounding the city, approximately 15 square kilometres, or 75% of the current plan area, offers a buffer. The first reference to the belt is found in the April 1966 brochure entitled 'Auroville – Report on a Township to be constructed in South India,' which mentions an 'isolating zone of great natural beauty will be maintained around the city ...'¹⁸ Elsewhere, Mother mentions:

a school of agriculture, a modern dairy with grazing land – there's a lot of agriculture, really a lot – fruit orchards, large rice fields, many things.¹⁹

¹⁴ Guigan, 2018, Vol. 1, 44.

¹⁵ Guigan, 2018, Vol. 1, 107. The inline additions and comments are Guigan's.

¹⁶ Guigan, 2018, Vol. 1, 133.

¹⁷ Guigan, 2018, Vol. 1, 114.

¹⁸ Guigan, 2018, Vol. 2, 149-50.

¹⁹ Guigan, 2018, Vol. 2, 56. Mother mentions this in an earlier formation, but it fits in to the plan for the Green Belt.

... fields, farms, etc., that were to supply the city.²⁰

We were not able to locate any at-length descriptions of Mother's vision for the Green Belt,²¹ but it appears that the space is meant to serve three functions: first, production of foodstuffs for the city with the aim of agricultural self-sustenance, with the remainder exported outside; second, to provide a protective green buffer for the four urban zones of the city to ensure a close-to-nature, ecologically vibrant and rejuvenating urban landscape; and third, to support research, innovation and education in forestry, agriculture, environmental regeneration and cyclical energy flows, with waste recycling and other ecological services.

ii. *Matrimandir and the Park of Unity*

Closer to the centre, the Park of Unity surrounding the Matrimandir is described as follows:

The Park of Unity will be divided into twelve gardens, which will represent the Twelve Attributes of the Supreme Mother and her Four Powers. In these gardens, I would like to have varieties of flowers – especially the different kinds of hibiscus – the Divine Consciousness. On the other side, towards the boundary of the gardens, I wish to have a lake, huge trees like palms, pines, various types of ferns, neem, Indian cork trees, eucalyptus and many other beautiful big trees. They all represent Unity and Aspiration. When the lake will be dug, all the soil will be collected on one side in order to make it look like a small mountain where there will be fir trees. You see, in future there will be snow. Beneath each tall tree around the Mother's Pavilion there would be small carved marble seats. People will meditate in the open and be one with the vastness of Mother Nature – the Mother of the multitude and Her Creation.²²

... the surroundings will be the same [as a photo of Kyoto's Garden Temple] – lake, flowers, trees, rockeries, small waterfalls and so on.²³

And finally, as the spiritual and material centre and soul of the city, the Matrimandir, a 'symbol of the future realization.' Several volumes have been written on the Matrimandir – on Mother's vision, specifications and stewardship of the early design and planning, and later phases of its construction, each inspiring in their own way – and it would take several more to do justice to the marvel that it is. Indeed, the power and ineffability of the experience one has in the Matrimandir is hard to capture in words; it needs a greater language than we possess:

Our human words can only shadow her.
To thought she is an unthinkable rapture of light,
To speech a marvel inexpressible.²⁴

We will therefore be brief, and note two points that bear on our discussion later:

²⁰ Guigan, 2018, Vol. 2, 109.

²¹ Given our time constraints, it is likely that we have missed some sources.

²² Mother's statement that there will be snow in Auroville is astounding. One can speculate if this was in anticipation of climate change, but only time will tell.

²³ Guigan, 2018, Vol. 2, 41, fn 1.

²⁴ Sri Aurobindo, CWSA, 1997, Vols. 33-4, 662.

First, the Matrimandir is a symbol in every sense. Its architectural form is a symbol of the sunlit path – the walk to the Inner Chamber represents effort and ascension to the spiritual ideal,²⁵ marked by the twelve Petal Rooms, and the Gardens, representing the twelve virtues one must practice in that journey.²⁶ The guided descent of light and illumination outwards represents the descent of Grace. The symbolism of a lotus, in the spherical structure with twelve petals, represents the blooming of the soul as in Sri Aurobindo’s symbol. The golden colour of the outer skin represents the Divine Truth. The four pillars represent the four powers of the Divine Mother – its aesthetic elegance, subtle opulence and irresistible charm represent *mahalakshmi*, its grandeur and beholding power represent *mahakali*, its illumination, calm wideness and stillness represent *maheshwari*, and the intricate perfection of its execution represent *mahasaraswati*. Its construction, from 1971 to 2008, was a symbol of the ‘fraternity of collaboration’ between an inspiring host of dedicated and daring Aurovilians with financial, architectural, engineering and organizational problems and disagreements aplenty, faced and resolved over time in the ‘aspiration towards unity.’²⁷ The massive excavation work, often done manually, by intrepid Aurovilians and others of all temperaments, was a symbol of working with matter. Its conceptualization was a symbol of the Truth ‘to teach people that it is not by escaping from the world or ignoring it that they will realise the Divine in life.’²⁸ Its trajectory from the humble origins of a degraded, barren and hard landscape to its glorious presence today is a symbol of the possibilities of work. Its physical space is a symbol of consecration, of a concentrated Force embodied in a material object. Its substitution of rituals, ceremonies and credal adornments with a practice of concentration is a symbol of a spirituality leading to experience rather than a credal religion. Its active and vibrant presence in a zone of stillness and solitude is a symbol of dynamism in silence. Its (original) policy of entry was a symbol of work and dedication as a qualification for entry into Auroville.²⁹ The urn, in its vicinity, carrying the soil of various nations and cultures is a symbol of unity in diversity. The water held in its surroundings, still under construction, represents a receptacle to hold the descending power of Grace. As Amal Kiran, a trusted disciple of the early days, notes:

Each zone must be in relation to the spiritual centre of the town which would dominate the architectural ensemble and serve as a constant reminder of the very reason of Auroville’s existence. This ‘Sanctuary of Truth’ and ‘Shrine of the Mother’, amidst gardens surrounded by a lake, would be the point of Unity upon which the four fundamental aspects of activity would converge.³⁰

²⁵ As Professor Joshi said, access to the Chamber is the ‘description of a process of yoga’; as Guigan notes, in the concept that has been implemented, one does go down before starting to climb up. Guigan, 2018, Vol. 2, 27.

²⁶ See, for example, Professor Joshi’s insightful discussion on these lines. Joshi, Twelve Gardens of Matrimandir, n.d.

²⁷ This was Mother’s message at the start of excavation work. Guigan, 2018, Vol. 1, 235. As we note in Part III, the engineering and architectural disagreements amongst those involved in early design is reminiscent of those today. See, for example, Guigan, 2018, Vol. 2, 43-45.

²⁸ Guigan, 2018, Vol. 2, 260.

²⁹ As Mother noted: ‘In principle not for visitors, reserved for Aurovilians; but not everyone will be admitted. The first condition for those who want to go there is to ask. Those who have contributed to the construction will be admitted in the first place. If there are doubtful cases, they should be referred to me. All those who have a doubtful presence should not go. If there is the slightest doubt, the case should be presented to me. People must be known for their qualifications.’ Guigan, 2018, Vol. 2, 389.

³⁰ Sethna, 1992, 10.

Matrimandir is thus a complete symbol of Auroville. As Mother noted:

Let the Matrimandir be the living symbol of Auroville's aspiration for the Divine.³¹

It is like the Force, the central Force of Auroville, the cohesive Force of Auroville.³²

Second, this symbolism can guide the development of the city today. The design was worked out amidst divergent architectural models attempting to materialize Mother's vision; the acquisition of land was a challenge overcome; the raising of funding was difficult yet achieved; the physical labour involved individuals of all persuasion – Aurovilians and villagers, resident engineers, architects and external experts,³³ contractors and volunteers, children and adults, men and women of various nationalities, intellectuals and labourers – unified even amidst disagreements in a common endeavour; the organization of work, including the delays in construction (as discussants informed us) was a symbol of how collectives can work together and the problems that can derail them.³⁴

In that spirit, as one discussant insightfully noted, 'Matrimandir is a code. All our current problems of city-building were solved there, if only we know how to read that code.' Not only its history, but the continuing Presence and Guidance of the Mother, which can be felt in its atmosphere, can resolve problems Auroville faces presently. As Mother said,

I take it upon myself to make it into a very strong centre.³⁵

The Matrimandir is directly under the influence of the Divine.³⁶

iii. A Symbol for the Future

The description of the physical manifestation of Mother's vision above is summed up in her symbol for Auroville, also a quartet.³⁷ Mother explains the significance:

The dot at the centre represents the Unity, the Supreme.
The inner circle represents the creation, the conception of the city.
The petals represent the power of expression, realisation.³⁸

³¹ Guigan, 2018, Vol. 2, 221.

³² Guigan, 2018, Vol. 2, 154.

³³ As Mother noted: 'The building of the Matrimandir now requires the support of all men of goodwill, both inside and outside Auroville. The help of specialised and qualified contractors, backed and supported by the enthusiasm and faith of the Aurovilians, is necessary for its rapid construction.' As we note in Part III, the reluctance towards external expertise in several key areas may be informed by this message. Guigan, 2018, Vol. 2, 282.

³⁴ See, Lohman, 1986, for an inspiring account; Majumdar, 2017, 156-8.

³⁵ Guigan, 2018, Vol. 2, 261.

³⁶ Guigan, 2018, Vol. 2, 280.

³⁷ In a generous gesture, the Government of India accorded special protection in July 1999 to the name 'Auroville' and its emblem under the Emblems and Names (Prevention of Improper Use) Act 1950. This, as we note below, is one of many instances of Government support for Auroville. In general, Central Government grants account for approximately 12% of external grants and donations from 1992-2022.

³⁸ Guigan, 2018, Vol. 2, 273.



Let Auroville be the symbol of a progressive Unity. And the best way to realise this is a unity of aspiration towards the Divine Perfection in work and in feeling, in a consecration of the entire life.³⁹

In summary, Mother's vision is:

- (i) *Constitutional*: it provides the basic architecture of Auroville, spiritually and spatially.
- (ii) *Vast*: it is comprehensive across all sectors of human activity, commerce and industry, farming and ecology, arts and sciences, research and education, urban planning and rural outreach, politics and organization. Nothing is left out, all is transformed.
- (iii) *Integral*: it is aesthetically inspired, in wise anticipation of governance, industrial and urban problems, life-affirming and powerful, and attentive to details of execution – representing the four powers of the Mother. It is powerful – more than a city, but a collective action to manifest and radiate the New Creation against all opposition. It is beautiful – an aesthetically enlivening, rich manifestation of a higher form, the suprarational beauty. It is research oriented – a city dedicated to the descent of Knowledge. It is balanced – a harmonious arrangement of complexity.
- (iv) *Urban*: it is a high-density project, with all the trappings of modernity chastened to an evolutionary spiritual ideal to lead urban reform.
- (v) *Cosmopolitan*: it is a uniquely international enterprise, at a time of rising nationalisms, a melting pot of diversity, not only in name but in living practice.
- (vi) *Specified*: it is detailed and specified to a high degree (insofar as conceptualizations go), with a range of projects clearly identified (which can serve as benchmarks to measure progress today, as we do in Part III).
- (vii) *Execution-oriented*: as Mother's handling of the early execution shows, it is a blend of spiritual idealism and pragmatism. It is charged with hope and energy for a new

³⁹ Guigan, 2018, Vol. 2, 319.

world, *with* a practical discipline for its realization, pushing to create something unique, a forerunner for mid-sized aggregates elsewhere.

- (viii) *Playful and experimental*: it is pushing for innovation and creativity, for new solutions, without arbitrarily rejecting those from the past. Importantly (especially given discussions during our research), it is playful, a *līlā*, without unnecessary ‘solemnities.’⁴⁰ As Mother remarked in the early design process, a timely reminder today perhaps, it is ‘a pity, men have too little sense of humour! Otherwise we could have great fun. It’s a wonderful remedy.’⁴¹

It is, in essence, a manifestation of Sri Aurobindo’s ideal:

We do not want to rule out any activity of the world as beyond our province. Politics, industry, society, poetry, literature, art will all remain, but we must give them a new soul and a new form.⁴²

A city dedicated to the realization of the Divine in Matter, through the practice of a world-affirming and communal yoga, is without parallel. One conceptualized, consecrated, planned and overseen in its early execution by the Divine incarnation, an embodiment of *shakti*, even more so. Auroville is the Divine Mother’s spiritual gift to the world:

Sri Aurobindo and I have concentrated this Force on the whole town; it is palpable, perceptible as a very concrete perfume which penetrates, but one must be able to feel it, to receive it.⁴³

*

⁴⁰ Guigan, 2018, Vol. 1, 240.

⁴¹ Guigan, 2018, Vol. 1, 186.

⁴² Sri Aurobindo, CWSA, 1997, Vol. 4, 362.

⁴³ Guigan, 2018, Vol. 2, 261.

B. THE GALAXY PLAN

Mother's plan – the quartet-city sketch and allied specifications – were translated into an architectural and urban planning concept by the French architect Roger Anger at her invitation. She noted:

I always felt [he was] the man for this project.⁴⁴

Now I have my plan of Auroville; I am waiting for Roger to make the plans because since the beginning I have said, 'Roger will be the architect', and I have written to Roger ... And when he comes, I'll show him my plan, then he will build the city.⁴⁵

In this section, we outline Mother and Anger's early collaboration, leading to the Galaxy concept.

i. Early Planning and the Galaxy

Anger was appointed in March 1965, and first visited the proposed site for Auroville, then barren and unproductive, in September of that year. In that visit, he presented Mother with an eight-page report outlining his preliminary proposals.⁴⁶ She approved of his proposal for the phased development of the city, with 10,000, 20,000, 50,000 and 100,000 inhabitants in 5, 15, 20 and 30 years respectively, with a residential density of 4 inhabitants per 100 sq. metres of accommodation and an average of 75 accommodations per hectare (or 7500 per sq. km.), a 'very reasonable figure.' This figure was changed three months later in December 1965 to a maximum ceiling of 50,000 inhabitants. On this, Mother noted:

The town is planned to reach gradually a maximum population of 50,000 inhabitants.⁴⁷

Similarly, the 'first masterplan' of 1968 makes clear:

At its final stage of stability, Auroville will have 50,000 citizens. This population should permit a harmonious functioning of the town. This number has been fixed from the outset.⁴⁸

We consider the question of densities below. The archival records show that the work at the time was focussed on the identification and acquisition of lands (which we discuss in Part III.B), the design and construction of the Matrimandir (which is beyond our scope here) and the concept or design of the city itself (which we consider presently).

⁴⁴ Guigan, 2018, Vol. 1, 97.

⁴⁵ Guigan, 2018, Vol. 1, 101.

⁴⁶ Guigan, 2018, Vol. 1, 2018, 120-4. We rely on Guigan's translation of the original French.

⁴⁷ Guigan, 2018, Vol. 1, 130; II, 388. There is some historical uncertainty on who first proposed this number, Mother or Anger. *See*, Majumdar, 2017, 236: 'Fifty thousand, it has always been 50,000. I don't know why I would have given a number. If she had told me 10,000, I would have 10,000; 20,000 I would have taken 20,000'. Recollections may vary with time, and as not all conversations were recorded, it may not be possible to verify this fact with certainty. In any case, this is a moot point as Mother proposed the number expressly twice. Guigan notes that the conversation of July 27, 1972 is 'the only record of Mother speaking of 50,000 inhabitants in Auroville. Though it seems obvious that she mentioned this figure to Roger (and others) in September 1965, there is no record of it.' This does not seem to be correct, as she approves it earlier in December, 1965 in a questionnaire with proposed answers sent to her by Gilbert Gauché. We have not had the benefit of studying the original documents in their entirety, so this may require further study.

⁴⁸ First Masterplan, 1968, 2.

On March 8, 1966, a year after his appointment, and on his second visit to Pondicherry, Anger presented to Mother two concepts or models for the city – the ‘rectangular’ and ‘nebula’ concepts. As Guigan reports,

Mother rejects a ‘Rectangular’ concept, which is not based on her own sketch of the town, and accepts wholeheartedly the ‘Nebula’ concept, which is based on her sketch of the town and whose road network is based on her symbol. The diameter of the town is 3 km.⁴⁹



The Nebula plan is Mother’s symbol translated into an urban design. With the Matrimandir at the centre, radiating out from which are four lines / paths that join an encompassing circular line / path (the ring). From the ring further radiated out twelve lines / path to an outer circle on the periphery of the city. The four inner quadrants represent Her, the Divine Mother’s, powers, and the twelve outside represent the twelve aspects or virtues for the work.⁵⁰ Mother recorded her appreciation for the Nebula model two days after:

Yesterday, I saw only the plans and models of the town that are simply wonderful, just as I wanted them to be ... I talked with Roger only this afternoon and he told me all his plans of action and work which are excellent.⁵¹

A month later, on April 23, 1966, Mother interestingly notes:

And the remarkable thing is that I simply told Roger the broad outlines, asking him if he was interested. Then he went back to France and he received my formation (my old formation, which I myself had left asleep); he received it there. I found that very

⁴⁹ Guigan, 2018, Vol. 1, 144.

⁵⁰ See, Mother, CWM, 2002, Vol. 6, 39.

⁵¹ Guigan, 2018, Vol. 1, 145.

interesting. He received it, he said to me, ‘It came all at once, I seemed to be possessed by something, and in one night the whole thing was done.’⁵²

Mother here is referring to a formation of an ideal collective she had conceived while residing in Paris. This was not manifested but recorded in a subtle plane. This channelling of the old formation into Anger’s ‘Nebula’ concept, and the associated road networks, demonstrate Anger’s receptivity (which Mother explicitly accepts, as is not always the case with several others who report in such inspired experiences) and his alignment with her vision. He was not alone – Mother also notes the contributions of Anger’s friend, Pierre Braslawski.⁵³ As Guigan notes, contemporary testimony indicates that it was Braslawski who had the vision of the Nebula and ‘it is very possible that Roger then came up with the idea of basing the city’s road network on Mother’s symbol.’ In either case, Mother’s approval of both the vision and the road network, and thus Anger’s alignment with her ideal, is clear in the passages quoted above.

Anger, however, found the straight-line geometry of the Nebula plan too static, reminiscent of ‘military cities.’⁵⁴ This dissatisfaction led to a more dynamic model, with a ‘spin’ added to it. In early 1967, Anger presented Mother with a revised model for the city – the ‘Macrostructure’ Model. This is an iteration of the Nebula (working around the existing villages of Kottakarai and Edayanchavadi), with the curvature of the road network, still Mother’s symbol, modified to match the more dynamic curvature of the model. While the design is different, the symbolism of the circulation network is similar: an inner circle with the Matrimandir, four curved radiating lines between the primary zones, then a circle in the middle (the ring) and twelve radials spiralling out to the circle on the periphery. The Macrostructure gave a dynamic spin to the Nebula. Anger also reduced the diameter of the future town in this model from 3 km to 2.5 km ‘so that the future city doesn’t have to develop on top of these two villages.’⁵⁵ Considerations of displacement of the villages seem to have motivated in part Anger’s planning, which seems to bring into doubt Guigan’s remark that ‘Roger’s Galaxy concept/model was entirely conceived in Paris, France without any consideration for any of the site’s feature.’⁵⁶ At any rate, as we note below, Mother’s approval of the Galaxy Model is not subject to the same objection.

⁵² Guigan, 2018, Vol. 1, 152.

⁵³ In commenting on Braslawski, an architect with connections to the USSR, Mother hopes for a coming together of the American and Soviet factions in Auroville amidst rising tensions (now resurgent in Ukraine). The representative character of Auroville – a microcosm to solve the world’s problems – occupied much of Mother’s thinking, and it is interesting to consider Auroville’s potential today.

⁵⁴ We rely here on the Auroville Archives’ summary. Auroville Archives, 2022.

⁵⁵ Guigan, 2018, Vol. 1, 182.

⁵⁶ Guigan, 2018, Vol. 1, 168. Similarly, Mario Heymann’s presentation to UNESCO in November, 1966 also records some limited features of the site. Heymann, 1966.

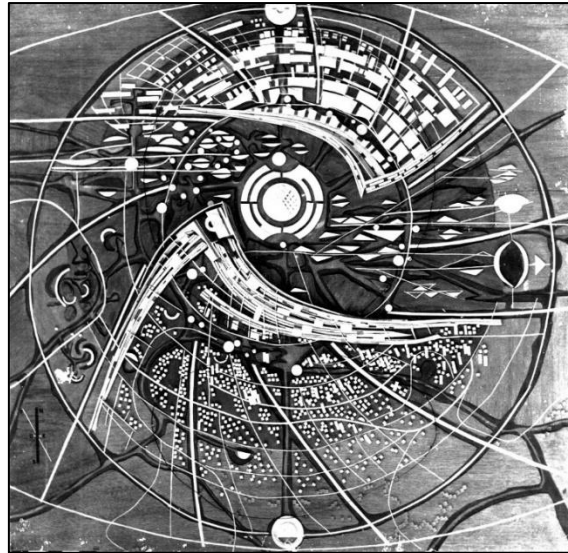

We could not locate any records that speak to whether this model was shown to the Mother. In any case, as the Auroville Archives note:

Finding that the two massive building masses of the Macrostructure design [precursors to the Lines of Force] were ‘enclosing the Matrimandir’ a bit too much, Anger and his team continued developing the design for the township.⁵⁷

Finally, in early 1968 (before the inauguration ceremony), with the centre of the city, the Banyan Tree, having been identified but the precise location of the Matrimandir yet to be decided (which would happen in 1970) – Anger presented Mother with the Galaxy Model. This model is a further iteration of the Macrostructure concept, though seemingly without the road network, which was received enthusiastically by the Mother.⁵⁸



(An early model of the Galaxy Plan, 1968. *Source*: Auroville Archives, 2022)

⁵⁷ Auroville Archives, 2022.

⁵⁸ Nightingale notes this point an interview with *Auroville Today*, available on the Auroville webpage, ‘Auroville Planning and Architecture’, 2020.

It conceives a spiralling, circular movement of the galaxy, divided into four zones, with the uniquely curved lines of force – high to low rise density buildings streaming out – accentuating the galactic movement, with the Matrimandir at its centre.⁵⁹ Mother signed the Galaxy Model to signify her approval, with the additional comment that it is a ‘movement of nebula which already exists in the cosmos,’⁶⁰ which seems to indicate that the Galaxy Model is in alignment with the natural movement of the cosmos.

Ciconesi and Ciconesi, who played an important role in the construction of the Matrimandir, reflect back on that time:

The foundation stone of Auroville was laid on 28 February 1968, in the presence of some 5,000 delegates. Youth from 23 states of India and 124 countries of the world placed a handful of soil from their state/country into a marble-clad urn shaped like a lotus bud ‘to mingle in it without manmade divisions’ in a symbolic gesture. It was during this ceremony that Auroville’s Charter was read in different languages: foreign and Indian. There was great expectation of building ‘The City of Dawn’, ‘The City of the Future’. The ground reality was a barren plateau of red laterite earth with a few palm trees, peanut fields, deep canyons caused by erosion over the years, hardly any skilled construction labour, sleepy little villages, where bullock carts, sheep and goats lived amiably, braving dust storms, the blazing scorching sun in the summer and monsoons where the sea became red from the water runoffs.

For Roger Anger (1923–2008), the French architect, was invited to design this city sometime in 1965. Having been trained in the final post-war era of the original *École des Beaux-Arts* system, an understanding of architecture as a plastic art had been instilled in him. It was this penchant for formalist composition that would come to define the iconic vision for Auroville.

The extraordinary Galaxy masterplan of Auroville that evolved from a sketch made by The Mother in 1965 has been an inspiration for many. It came at the right time: the youthful idealism of the 1960s was strong and change was in the air: the hippie movement, the students’ revolution and the heroic period of the Modern Movement was coming to an end. Young people were searching for new forms to embody a new consciousness ... [It] reflected the zeitgeist of the time.⁶¹

The following was Mother’s inaugural message, in French and English, read out at the Inauguration on 28th February, 1968. The ceremony started with Mother reading in French a welcome message and then the Charter. She was in her room in Pondicherry at the time and the message and the Charter were broadcast to Auroville by All India Radio. Thereafter, the Charter was read in sixteen languages. During this reading the soil from 124 countries and 23 Indian states was placed by chosen youth representing each culture in a raised marble urn, next

⁵⁹ Ciconesi and Ciconesi, 2012.

⁶⁰ Majumdar, 2017, 236.

⁶¹ Ciconesi and Ciconesi, 2012.

to the site for the Matrimandir, as a symbol of human unity. The vitality, hope and promise in the photos from the inauguration shine through.⁶²

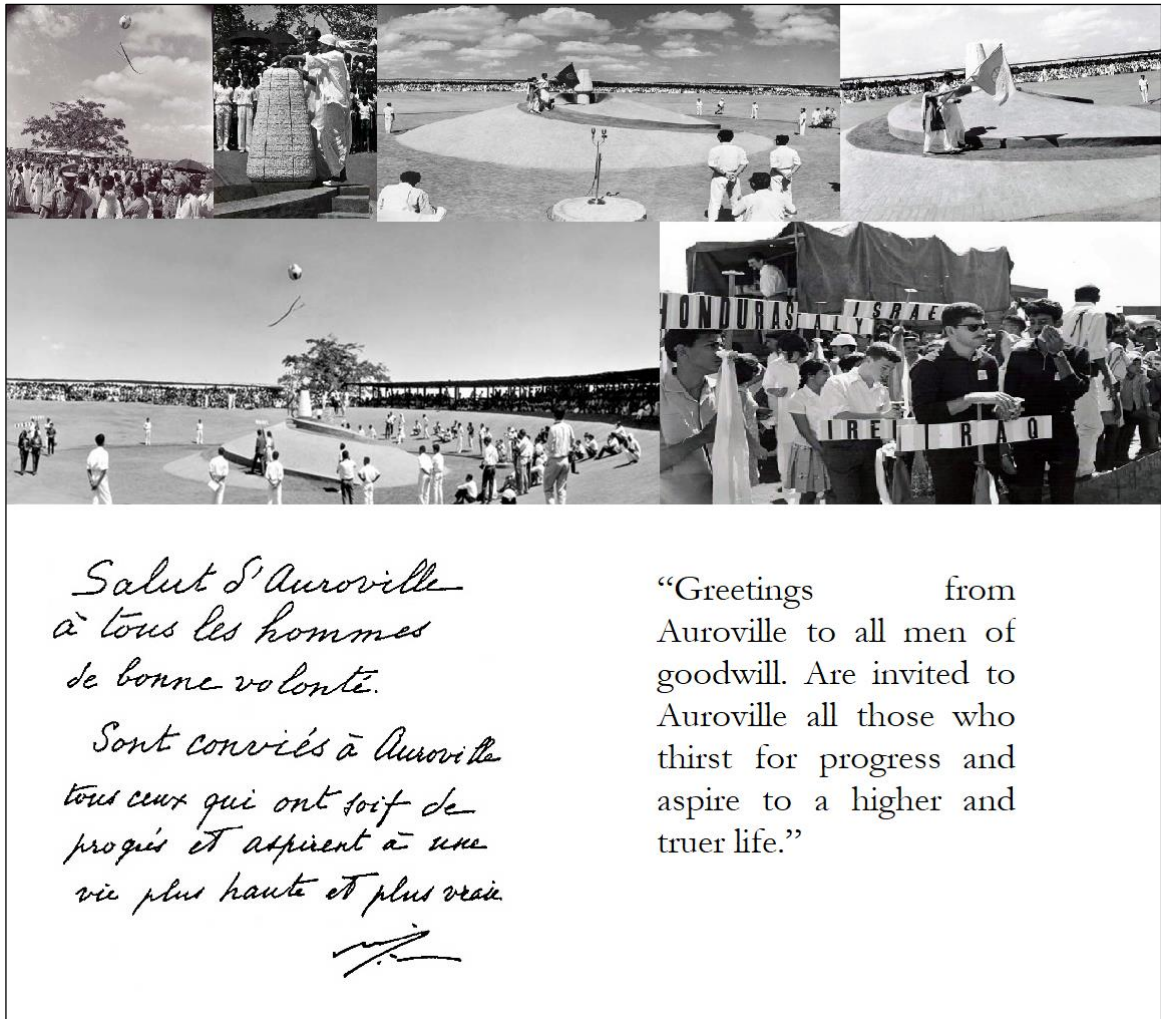

(Source: photos and copy of Mother’s message from <<https://sri-aurobindo.co.in/workings/audio/auroville/index.htm>>)

The Galaxy Model was thus fixed, with – to the best of our knowledge – only one change in July 1971, when Mother rotated the Galaxy by 50 degrees counterclockwise on Anger’s suggestion. This was done to accommodate the construction of Bharat Nivas in the International Zone, as money for the project had been sanctioned by the Government of India yet the land for it in the original formulation of the Galaxy Model had yet to be acquired.

We may note here Mother’s and Anger’s collaborative ethic, speed of work and sense of urgency (completing the work, with four iterations in three years, alongside other proposals and work on the Matrimandir), whilst maintaining a high spiritual and aesthetic ideal – a point which we consider in Part III.A, in relation to the slow growth of the urban environment and planning disagreements since. Indeed, we note that Mother’s trust in Anger (‘the man for this project’), whilst naturally not a marker of infallibility, requires us to accord great weight to his

⁶² For a beautiful record of the Inauguration Ceremony, see, Majumdar, 2017, 62-9.

views as her chosen instrument for the work.⁶³ At various points, she admires, supports and in some cases, on the issue of the design of Matrimandir, provisionally defers to his views. For example, she notes:

I told you already that I am waiting for the architect of Auroville who is coming at the beginning of September and we shall do together the plan of the town. I shall explain to him what I want and things will be done accordingly ...⁶⁴

Now I have my plan of Auroville; I am waiting for Roger to make the plans because since the beginning I have said, 'Roger will be the architect', and I have written to Roger ... And when he comes, I'll show him my plan, then he will build the city.⁶⁵

And it will be a small building, not a big one, with just a meditation room downstairs, with columns and probably a circular shape (I say 'probably' because I am leaving it for Roger to decide).⁶⁶

It is Roger who will lay the first stone of the Pavilion [of the Mother] ...⁶⁷

[When asked, 'When is the beginning of the construction planned to be?', Mother replied:] Nothing can be said without consulting Roger.⁶⁸

ii. *Features of the Galaxy*

As basic constituents of the Galaxy Model have been discussed in detail elsewhere, we will keep our discussion brief. In interviews with *Auroville Today* in 1988 and 1992, Anger explained the concept as follows:

Mother had given a couple of parameters: the division of the city into four areas, or zones, and the number of people for whom the city is envisaged (50,000). The division into those four zones (industrial, residential, international and cultural) is unique and has no precedent in town planning. On the basis of this scheme, we, the architects and town planners, started to make suggestions to her. This was done in several stages, and finally, the Galaxy came out and was presented as a model to Mother, and accepted by her as a plan that answered her parameters. She inspired and guided the work. When I talked to Mother one day about Auroville, she said that the city already exists in a subtle level, that it is already constructed, that it is only necessary to pull it down, to make it descend on earth. The galaxy plan shows the four zones, which are interconnected through the 'Crown,' the second circular road around the Matrimandir. From the Crown, twelve roads radiate outwards as part of the infrastructure. Some of them are accompanied by a succession of high-rise buildings, which constitute the so-called 'Lines of Force', essential for the framework of the city and for the integration of all access to the city centre. But the plan is not finished. On the contrary, the city is still to be invented, everything has still to be done through the daily experience and rhythm of the Aurovilians. Apart from these lines of force, everything is flexible, nothing is fixed.⁶⁹

⁶³ Again, we did not study Anger's personal archives, which may lead to further reflections.

⁶⁴ Guigan, 2018, Vol. 1, 119.

⁶⁵ Guigan, 2018, Vol. 1, 101.

⁶⁶ Guigan, 2018, Vol. 1, 103.

⁶⁷ Guigan, 2018, Vol. 1, 125.

⁶⁸ Guigan, 2018, Vol. 1, 130.

⁶⁹ We could not locate originals of the interview. See, Auroville webpage, 'Galaxy Concept of the City', n.d.

Insofar as the basic constituents of the Galaxy Model go, two points can be noted: Mother's unambiguous approval and natural flexibility within the model.

a. Mother's Approval of the Galaxy Model

The Galaxy concept translates Mother's quartet-city plan into physical form, with clearly identified zoning. Mother's enthusiastic reception of the Nebula Model, her signed approval of the Galaxy Model and appreciative comments subsequently demonstrate an unambiguous 'yes.' Some have argued that Mother's signature, and short comment, need not necessarily signify an approval cast in stone today. This is unconvincing, and three short comments are in order.

First, as Anger points out, and the Mother repeatedly notes, the city already exists on a subtle plane, waiting to descend: her approval for the Galaxy Model then indicates that it is aligned with (perhaps even inspired by) that subtle creation. This is important because it signifies that the *form* of the Galaxy Model carries spiritual significance – Mother's vision and will represents in this key area is not just one creative choice out of many, that can be revised, even with the best of intentions, by individuals today, but one that carries a significance of the descent of a higher form *as defined* by her. Tellingly, Anger's self-testimony describes the design process that led to the Galaxy Model in these terms as well:

If the Galaxy has a force, it is because she inspired it. To conclude I can affirm, that this Galaxy is in fact Her realization, Her will ... I did not bring anything to it personally – only being a kind of instrument.⁷⁰

While dogmatism is to be avoided and plasticity is necessary to adapt to changing circumstances, adherence to the core structure approved by Mother – which we must consider to be thorough and well-thought out, not a choice made lightly, especially as it concerns the all-important architectural mould of Her city – is neither dogmatic, nor does it preclude plasticity. Rather, as we discuss below, it pushes to find creative solutions to manifest her vision for the future.

Second, shortly after Anger's presentation of the plan, on 20 April, 1968, Mother noted that a photo of the galaxy (of stars, not the Model) sent to her is 'identical to Auroville's plan' and represents the 'future.' Commenting on the photo, Mother remarks that it – and by extension the identical Model – is 'lovely.'⁷¹ We may note here that some argued that Mother's age at the time of approving the Galaxy Model must be kept in mind, as She was relying entirely on her advisors and instruments rather than making independent decisions or inquiries. This objection does not hold water – Mother's attention to detail and precise oversight, including a rejection of earlier models, is amply demonstrated in the *Agenda*. Indeed, Mother anticipated and mischievously replied to this objection at the time:

⁷⁰ Majumdar, 2017, 238.

⁷¹ Guigan, 2018, Vol. 1, 282.

You see, they say, ‘Mother is old, she doesn’t go out any more, she can’t see any more, she doesn’t know what’s going on.’ But I know what’s going on – I have other ways of seeing! (laughter).⁷²

Third, as the figures below demonstrate, the Galaxy Model was an iteration of the Nebula, which Mother admired in no uncertain terms. Her signature on the Galaxy Model is to be read with earlier comments on the Nebula concept. As such, her approval is clear.

⁷² Guigan, 2018, Vol. 2, 270.

Iterations of the Nebula Concept, leading to the Galaxy Model:

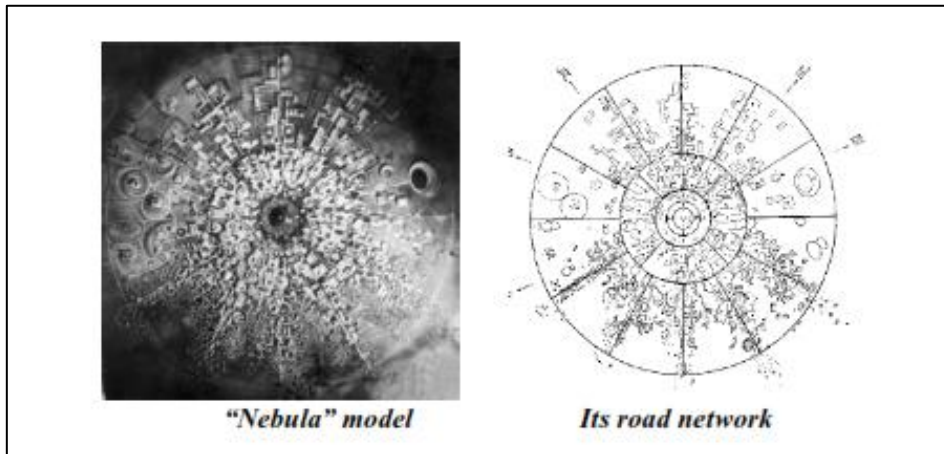

(Model of the Nebula plan. *Source:* Guigan, 2018, Vol. 1, 144)

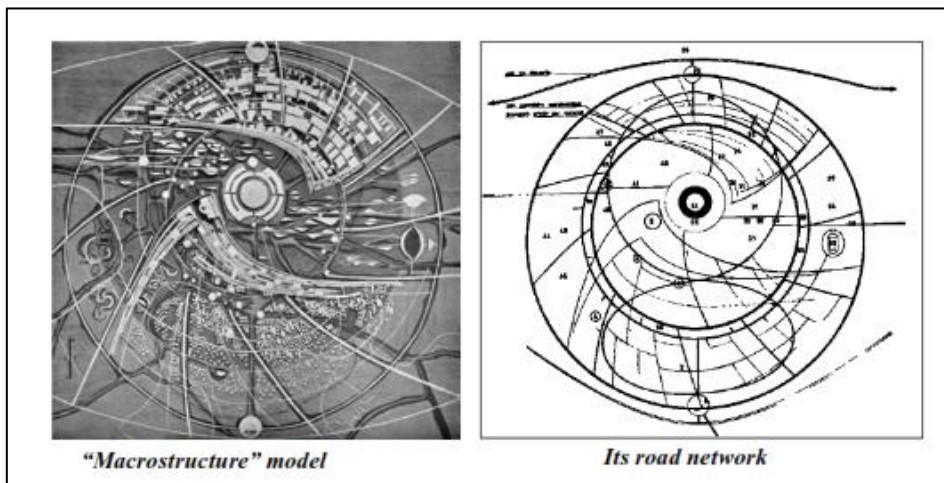

(Model of the Macrostructure Model, with its road network. *Source:* Guigan, 2018, Vol. 1, 181)

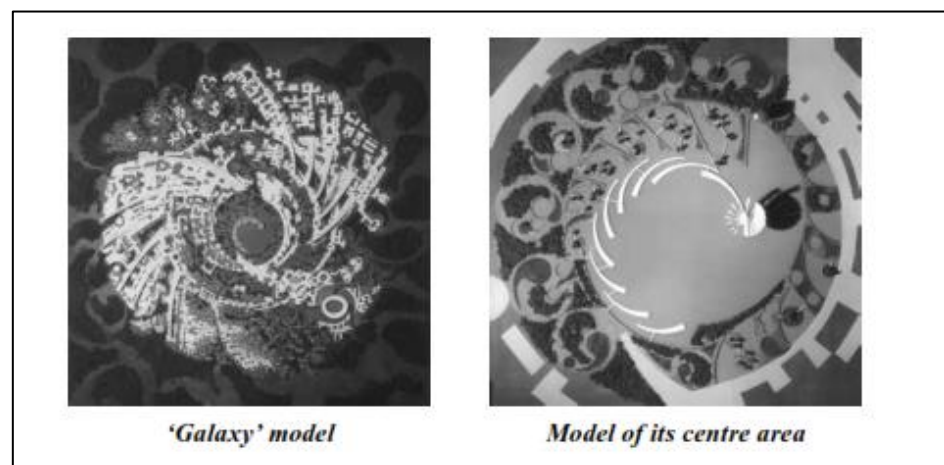

(The Galaxy Model, and a model of the centre. *Source:* Guigan, 2018, Vol. 1, 282)

Some doubt was raised during our research that the absence of the road or circulation network in the Galaxy model in contrast with the Nebula concept indicates that this was a later inclusion without Mother's express approval. We were not able to access Anger's personal archives to clarify whether the road network of the Nebula concept is to be read as part of the Galaxy Model, or if this was an express departure. However, this conclusion seems unmerited from the records we were able to study. As the Auroville Archies' helpful and lucid summary of the design process notes:

Models made of the Galaxy Plan in the first few years of its existence do not show any road network at all. This is because the models are massing models, showing the general massing and layout of buildings. Even though photographs of these models are what have made the Galaxy Plan so iconic, and in many cases have compelled people from all over the world to come here and dedicate their lives to Auroville, these models do not have the detailing to show things like road networks. However, as soon as Anger and his team started to develop the road network for the Galaxy, it became obvious that the Galaxy's circulation network is descendant from the Nebula and Macrostructure Plans. Seeing this progression of the circulation network of the Nebula, Macrostructure and Galaxy Plans [see figures below], it becomes clear that the Galaxy Plan's circulation network is based on the Mother's Symbol, with a dynamic 'spin' to it!⁷³

Iterations of the Circulation network, demonstrating the continuity from the Nebula plan to the Galaxy Model, with no roads or paths in the first models of the latter:



⁷³ Auroville Archives, 2022.

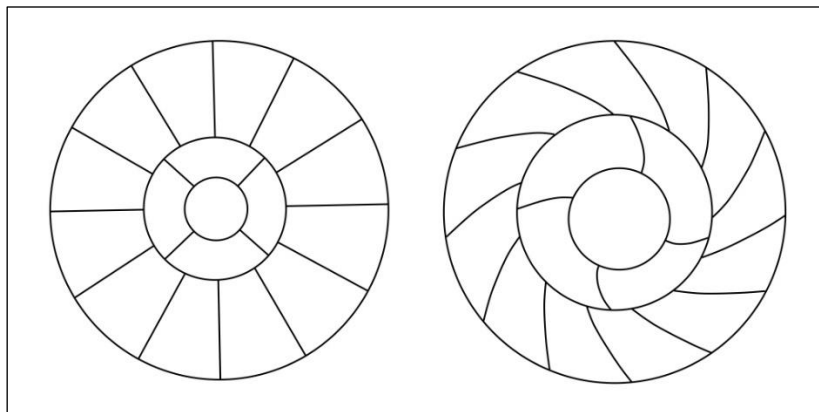
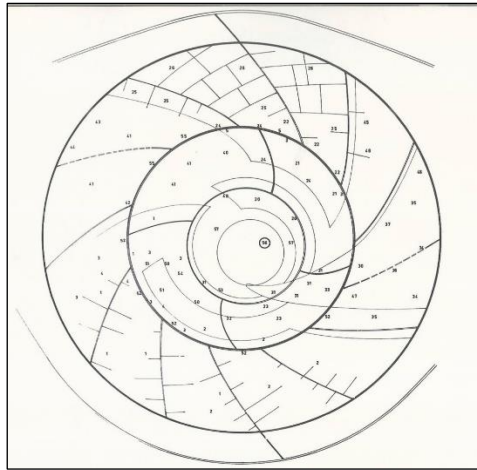

(*Top*, transition from Macrostructure to Galaxy designs, emphasizing the circulation network. *Middle*, layout of the circulation network of Galaxy Plan, 1968, emphasizing the circulation network. *Bottom*, comparison of the basic circulation network of Nebula Plan (1966, *left*) and Galaxy Plan (1969, *right*). *Source*: Auroville Archives, 2022)

The continuity between the models, and successive iterations of the symbol approved by the Mother, lead to the reasonable conclusion that she approved the circulation network (three circles, including the Crown, with four plus twelve) in the later Galaxy models. Her approval of the first Galaxy model and subsequent detailing work by Anger is best seen in light of the approval of the circulation in the Nebula.⁷⁴

⁷⁴ We can note here that Anger's discussion with Mother on the need to replace cars came after the approval of the Galaxy Model: Anger suggested 'another ... more healthy, less clumsy and noisy and aesthetical' alternative, to which Mother pointedly replied, 'small size electrically powered vehicles, capable of transporting about 200 kg at a speed of 15 km/hour'. Guigan, 2018, Vol. 1, 121. This seems to indicate that roads with a mobility function are part of the Galaxy Model, but as with other elements, the form must avoid the pitfalls of bad mobility planning, and travel beyond 'just a road' in keeping with the aesthetic and spiritual ideal. The debate seems to be whether the Crown and Radials are roads only, or something more than roads, an 'urban artery' (roads +). As various architects, planners and mobility experts we discussed the issue with notes, the mobility provided by a road network and the urban artery are not mutually exclusive. This harmonizing position seems to be in line with the limited comments by Anger we have studied. Nightingale seems to suggest this – 'the Galaxy Model is a concept model, it's not meant to answer all the questions straight away ... it's our task to tease out solutions from it.' As we note below, it demands creative solutions for its manifestation, and Nightingale's caution that one must not 'down complex aspects into lowest common denominator solutions' is important. *See*, Auroville webpage, 'Raising the bar on mobility and urban planning', 2020.

b. A Framework with Flexibility: the Galaxy Today

The Galaxy Model specifies three ‘essential’ aspects, in addition to the primary zones – the Crown, twelve Radials and the Lines of Force.⁷⁵ It consciously leaves open all else to future decisions. It marries – in a dynamic and aesthetically inviting vision – the need for flexibility and organic development, which the Masterplan later translates into a planned and systematic approach embodied in the core framework of the concept approved by the Mother.

The relevance of the Galaxy Model has always been at the centre of debates around Auroville’s development. For example, Mr. Denino, member of the International Advisory Council, notes:

Several respected experts and groups within and outside Auroville have worked hard to prepare this DDP over the years, and have proposed solutions to adapt the Master Plan to ground realities ... This will therefore require integration of the ground situation along with the projection of future scenarios ... Instead of welcoming these initiatives, my understanding ... is that a due process of dialogue, consultation and adaptation was discouraged and eventually scuttled, apparently under the belief that the original Galaxy plan must stand unaltered in every respect. Such a dogmatic line takes no account of the five decades that have elapsed since the Galaxy plan was formulated.⁷⁶

Over the years, some have creative objections to the model and have proposed alternate conceptualizations. Others have pointed out practical difficulties with its manifestation – particularly as regards to existing developments on the ground, village settlements in the plan area, environmental hotspots and other constructions, both housing and communal buildings – suggesting suitable modifications or changes to the 1968 Model. Yet others have insisted on an exact translation. The divides are often blurry, with a range of views falling within this spectrum.

c. A Middle Ground

Resolving the long, fractious debate on the Galaxy concept is key to planned developments going forward – to work towards some semblance of unity and fraternity in action – to avoid further delays. We consider this issue in Part III.A with reference to planning studies on the point. Unfortunately, in our conversations, the unhelpful rhetorical extremes of ‘rigid planning’ and ‘entirely organic development,’ which seemed to carry currency in the community, tended to obfuscate the deeper agreement. In this, the Final Report of the 2015 Retreat, offers a helpful reconciliation in the following terms. We consider this point, the so-called ‘elephant on the room,’ in Section D below.

⁷⁵ It is worth noting here that the Lines of Force offer an interesting ground for experiment on energy efficiencies, social cohesion and density management in high-rise versus low-rise buildings.

⁷⁶ Danino, 2021, 2; *see also*, Majumdar, 2021.

Milestone I:	
Develop a connection between the galaxy plan and ground reality.	
Most critical challenge	Enabling conditions for this to happen
1. Willingness to have a flexible approach from all sides and the various stakeholders.	1. Identify the essential features of the galaxy, categorize the topographical features to be retained.

(Source: Full Report, Auroville Retreat, 2015, 51)

The two positions are not antagonistic: the Galaxy plan provides, to the best of our understanding, a flexible mould, that can be creatively interpreted but not broken. Challenges in that enterprise are naturally aplenty (as experts agreed across the spectrum): yet, viewing the Galaxy as an invitation to create, rather than an imposing constraint to somehow build, seems to be in the spirit of Mother’s *līlā*, a laboratory of experimentation. This harmonizing and creative sentiment is reflected, with a varying emphasis, across the board in the available literature and in our discussions: the *framework* is firmly decided, not the *precise details* of its manifestation, which require expertise and imagination today to work *with* the ground realities in a spirit of *play*. The Full Report of the 2015 Retreat too suggests this approach:

3	We must built Auroville as per the galaxy plan.	The galaxy is outdated and we need a new plan.	<i>We build Auroville with the galaxy as an urban design concept while ensuring sustainable development that takes into account the natural resources and environment, contemporary insights in building technologies with low levels of embodied energy and urban plans that create a regenerative town.</i>
---	---	--	---

(Source: Full Report, Auroville Retreat, 2015, Annexure 5, 64)

This integrative approach has been a consistent refrain in planning discussions in Auroville – given our disciplinary limitations in urban planning and architecture, we quote a selection of five voices involved at various points and capacities in Auroville’s planning, Anger, Legrand, Revi, Doshi, Nightingale and Heymann, who point along these lines.

First, this seems to be Anger’s understanding of the Galaxy.

We could situate Auroville at the opposite end of the traditional approach of contemporary urbanism: in our urban conceptions, we conceive of a city on paper, however intelligent the conception may be, then we ask people to come and inhabit the city. Here, the approach is reversed: people live the experience, and from that experience, their living conditions and environment will be created and established.⁷⁷

⁷⁷ Danino, 2021 (translation is Danino’s).

Speaking in 1968, when the Macrostructure model was in play, Anger emphasized the need for ‘the most plastic formula’, ‘the evolution of the town in time’, within the body of the macrostructure:

Auroville will be a totally unprecedented psychological, social, educational and architectural experiment which, as with all experiments, might reveal errors. In truth not errors, but lacunae in man's urban consciousness. We would like Auroville to be a progressive, an evolving town, full of meaning, never to be ‘finished’. This continual growth does not refer to the number of inhabitants, which will not exceed fifty thousand, but to an evolution of the physical body, of the life of Auroville, of its society and also of its genius. This is why the most plastic formula will be the best from the urbanist's viewpoint. Here, by the way, we come to what will be the principle of tomorrow's urbanism: giving the town basic lines of power, main penetration channels, through a macrostructure that shapes the outlook and facilitates an inner direction. Then, just as with a bottle-rack, a mobile macrostructure is fitted in, and can be changed, modified according to the needs of the town, the zone, as well as the individuals. Urbanism cannot be separated from plastic, open-ended architectural vision. Both are striving after an environment where man can live and evolve with joy. A macrostructure, like a mountain, cannot easily be changed. The macrostructure is an arrangement of space involving an underworld of sewage pipes, of water and electricity connections, main circulation ways wandering through the surface relief, natural or artificial climatic conditions bathing the whole complex. Once the macrostructure is positioned, everything becomes possible. On this structure is laid an outer skin, changeable and plastic so that it may be stretched, so that its color may suddenly be altered all along an avenue by a play, let us say, of revolving panels. Such an approach is the only one that will allow an evolution of the town in time and within a given space. The clothing of the town may be changed, renewed without drastic destruction.⁷⁸

Second, Nightingale playfully notes:

If she'd [Mother] wanted us to build something easy, she could have simply chosen the first Grid Model. It would have been finished years ago ... The Galaxy Model is a nightmare from a planning point of view, and that's exactly the point. It has amazing qualities and amazing depth to it, which is what we're being asked to explore. We should be collectively going as high and as wide as we can, to work out how that would look today, including all the ecological and technological advances that have been made in the meantime.⁷⁹

Similarly, Majumdar quotes Legrand, a member of the early Town Planning Group:

The Galaxy can't be understood just as another functional architectural plan ... [the] plan has to be understood as life and as a tool to create a culture for the future. Without that, even the best plan will become a series of row housing and practical buildings but not the city of the future that the Galaxy meant when Roger worked on it.⁸⁰

Next, at a presentation given to UNESCO in the early design stage on November, 1966, eight months after Anger presented the Nebula plan to Mother, his associate, Mario Heymann

⁷⁸ Anger, ‘=1’, 1968.

⁷⁹ Auroville webpage, ‘Raising the bar on mobility and urban planning’, 2020.

⁸⁰ Majumdar, 2017, 226.

welcomed architectural diversity, and attempted to resolve the problem of divergent conceptions whilst maintaining the original idea:

We are working on a second version now based on the same programme:

Here the four zones are expressed more clearly. The intention of creating a more supple and dynamic plan has dominated this study at the expense of a multiplicity of architectural forms. The project has the *ability to ensure for the town a very characteristic shape*. Parallely, we have made architectural research with the aim of defining different forms of construction and atmospheres that we will have to create ... To integrate the buildings with the ground ... Set the two essential qualities to Auroville – Unity, Diversity. I want to insist on the last point. Ancient cities found their variety naturally, through hundreds of builders who built and by the centuries of construction. Their unity was assured by materials, traditions and ignorance of other styles. For Auroville, the application of a simple guideline for urbanism will permit variety but can lead to *chaos without a lack of coordination* (as in Parisian suburbs). Alternately, the construction of the whole town by a single team of architects will bring a strong risk of the opposite: a uniformity that is mistaken for unity. The difficulty consists in *integrating as many brains as possible without losing the original ideas*.

For problems in general we propose the following solutions: creation of a macrostructure constituting artificial floors, supported by a very large web of anchoring points. It is on these hanging floors the building could be integrated in a frame already structured and could be built by many architects. This macrostructure should minimize the cost on transportation.

Here are some advantages of this system: 1. The urbanist as an organizer of life is free to use 3 dimensions and can think in volume, even regarding circulations. 2. The silhouette of the town can be sketched on this artificial site. 3. This macro-structure *suggests ideas to architects for their building yet gives them suppleness* and freedom of expression. The urbanist will have to essentially ensure the *coordination between architects by a dialogue* based on sensitivities and not by the application of rigid regulations.

Auroville is destined to shelter men and women who seek to evolve and realize themselves. For Auroville to be a worthy example of this aspiration it is essential that its creation be a model without precedent of cooperation between people.⁸¹

Similarly, Revi incisively locates the problem in the context of urban planning, with a call to raise the bar in Auroville to intuit forms that can hold the power of the galactic symbol with movements in time:

Very few settlements have been created to serve as vehicles for evolution. Auroville is one of them. It is therefore, both a living system and an evolving one. A new language of building will therefore need to be intuited to articulate this journey. The galactic symbol; the material celebration of the emergence of the supramental from the subconscious; the four aspects of the Mother; her crown and lines of force provide an arena in which many forms of this music of transcreation will be played over this

⁸¹ Heymann, 1966 (we were not able to verify the contents as against the original; emphasis ours).

century. Our challenge will be to find the appropriate human instruments, the aspiration and lucidity to express them truthfully in material form.⁸²

Finally, commenting on this debate, and the delays in manifesting the Galaxy model, BV Doshi, the celebrated architect and former member of the Governing Board implored – in his last interview on 2 September 2020 before his passing – a return to idealism, innovation and the big picture beyond individual complaints, echoing again the same sentiment that the Galaxy concept is sufficiently plastic within its basic framework. Given his eminence and long-time involvement with Auroville’s planning, we quote his words at length:

The thing that I found was that Roger’s plan of the Galaxy ... to me it suggests a whole lot of visions. Visions of connectivity, potentials, diversities, huge amount of choices – including the potentials of getting a place for everybody. It was really the city of the universe. And why it is not happening, why it is not moving, I have no idea at all. So the question is: should we talk of it as a city, or should we talk about ‘galaxy’? There’s a big difference between the words ‘city’ and ‘galaxy’. I think we are talking about very small, micro level – and we are talking about Mother. It’s a big paradox, a huge difference between the two statements.

So when you look at the Galaxy – and I remember, often when I saw the model, and when I had been thinking there, and when there was a discussion going on – first thing is, ‘what is galaxy?’ Galaxy is the magnet of the universe in which things move, and they move in a dynamic balance. That is what I know. And I’m just guessing. And everything can be absorbed, and everything can manifest, and everything adds its own value and ability to regenerate, revitalize. And I think that is ‘galaxy’. Galaxy is not a small house with a compound wall. It’s a fluid thing, it has interconnections. It has many levels, it goes up and down, etc.

When the model was made, the model was not really representing the kind of galaxy that I had seen in Roger’s plan. And I think the first thing we should know is: are we really talking about a building? Or are we talking about celebration of life? That’s what I think Mother was talking about. How do you charge the souls to manifest their subtle existence and the purpose of their existence. Do we talk about this at all? Or are we talking about ‘my kitchen is not working,’ or ‘the costs are like this,’ or ‘I have no road,’ or ‘I have no water supply’... I think the issue is first, we should remove these words of architecture and building. We should talk about how do we celebrate life on this planet, and make a model.

So when you talk about celebration, you are talking about total sustainability relationships, potentials, expanding our ideas, expanding our horizons. And I think this is not happening. So we start talking about little things ... What Mother must be thinking!

And I think that plan shows you the micro, macro, all the levels of housing etc., can be built there. ... when I saw the Auromodèle houses which he had done in the beginning... you could see how this person who comes from Paris to be here [Anger], who had a large practice, gives away everything and does these little things here... and he talks about climate, he talks about fluidity, he talks about visions, and he talks about lightness. And I think those are the things which are pioneering works.

⁸² Revi, 2007, 7.

Earlier photographs which I had seen, from Piero and others, thatched buildings and thatched houses, when the land was absolutely dry, barren land – there was an aspiration. There was a vision. And there was an idealism. And it was not talked about, ‘what is the population’. We always look at it as if it is a part of the universe. We are global. We are not local, we are not regional. We are not small people. I think this is where the first difference to me is.

And that should be removed. And we should talk about saying, ‘how do we understand what galaxies are’. We don’t even know (I don’t know at all), but when I imagine, when I think about it, there is a dynamic balance, and that balance generates energies, and those energies help the whole cosmic order of the universe. In this, health and hygiene things come – but more than that, the inner sensitivities which Mother is talking about, come out.⁸³

In this understanding, one may suggest a relationship between manifesting the Galaxy and the yoga: manifesting the complex and dynamic features of Mother’s vision in a challenging and resistant terrain, with varying architectural and planning viewpoints, is an instrument (not just a pleasing metaphor) for spiritual growth, to overcome similar psychological challenges of that nature that present themselves in the process of the collective yoga. Manifesting the Galaxy is an outer reflection of the inner process. Anger captures this sentiment:

Auroville will undertake a perpetual search for the future with beings of high quality who will have, for a great deal, overcome their limitations, achieved a true communication, a true fraternity, based on openness, and an understanding of the other in a beautiful and harmonious environment within the context of an exceptional city ... I believe Auroville will finally become reunited to an inner law and then it will be like a lighthouse – an unbelievable fire.⁸⁴

We approach this subject with caution as we are not urban planners. Errors in our understanding are possible. We consider this issue in light of Mother’s words, and insights provided by those trained in these fields in Auroville and outside, who largely, but not uniformly, agreed that there are no insuperable difficulties and the Galaxy Model presents a creative challenge that is capable of manifestation today. Manifesting the Galaxy is not an easy task – as Ciconesi and Ciconesi beautifully put it, echoing a common sentiment:

Not surprisingly, every architect, town planner—every Aurovilian, in fact—begins at some point to ask themselves: ‘How does one merge the Galaxy concept with the ground realities without losing its essence? What should the process of its building be? Are we going in the right direction? What is our role in the region, India and the world? What is in fact the *raison d’être* of Auroville? Is this why I came here?’ And there are as many answers as there are Aurovilians, and each one has a place in the total puzzle that is Auroville.

Finally, it is not only the ‘finished product’ but also the ‘process’ followed, both within and without, that is most important in Auroville. It is about living in the present and yet aiming towards a future that seems impossible. Ideally then, the process of building becomes a means of learning and experience wherein all aspects of man’s

⁸³ Auroville City Conversations, 2020.

⁸⁴ Aware Auroville, 2023.

nature— physical, vital, mental as well as the spiritual—are developed and perfected.⁸⁵

It stands to reason that – the Galaxy concept having been approved by Mother in her wisdom – all efforts must be made to bring, as far as possible, the higher manifestation down, rather than to alter the manifestation itself. The descent of higher forms into the physical is a constitutive part of the spiritual process – this is naturally met with resistance and difficulties in the physical (in this case challenging parts of the terrain), but they have to be progressively and creatively overcome. Mother’s approval of the Galaxy plan read with the contemporaneous remark that the ‘city *already* exists’ in the subtle plans, waiting to descend, is probative evidence that supports the view that the form of the Galaxy is central to the planning mould of Auroville: if the Galaxy plan *existed* (i.e., already ‘built’) in the subtle in 1968, waiting to descend (slowly or quickly), that naturally forecasts its future mould relevant for us in the present. The logic of Mother’s statement indicates that we must bring it down now (unless the subtle creation is itself modified, a point on which argument is near impossible). Anger recounts Mother’s view on this point:

She always said that the city existed already and that it only needed to be brought down on the material plane. She kept saying, her face, I remember, with her face turned upwards with her two arms raised, She said: ‘but the city, my child, it is made, it exists, one has to bring it down.’⁸⁶

Elsewhere, Anger emphasizes this point, locating the Galaxy plan as an expression of Mother’s vision, not an architectural imposition of his own:

I strongly wish that we would stop referring to the Galaxy plan as Roger Anger’s plan. I would like to clarify this once and for all. It is not my vision, but the logical result of the research of a whole team over many months, and of the Mother’s presence in particular. Her inspiration and influence gave birth to the concept of the Galaxy. You cannot shake it off. I’d say it is not the image of the Galaxy that imposes itself on Auroville; it is the necessity of the city corresponding to Mother’s guidelines that leads us to the Galaxy.⁸⁷

It is natural for creative differences to exist in architectural, planning and aesthetic visions – indeed, each may want to plan a city, or particular zones, in their own way. But with Mother’s backing and approval, it is apparent from the archival record that the Galaxy Plan is central to *her* spatial constitution of the city, which is authoritative. As Anger astutely notes:

Is it for *us* to plan the city? Does the concept of this city refer to her vision or to *our* will? This the whole question.⁸⁸

⁸⁵ Ciconesi and Ciconesi, 2012.

⁸⁶ Aware Auroville, 2023.

⁸⁷ Aware Auroville, 2023.

⁸⁸ Majumdar, 2017, 237 (emphasis ours).

d. Ecology versus Geometry Debate

The ‘ecology versus geometry’ debate, ‘the big issue now in Auroville’, invited much debate in our interviews.⁸⁹ Briefly, the outstanding issue, from the 2003 Direction for Growth Report onwards, has been on detailing urban development guidelines to marry the Galaxy plan with ground realities:

The urban form for the City will generally correspond to the original galaxy plan shape. If it has to be modified in order to suit topography or to overcome unforeseen constraints, it will be through wide-ranging discussion. Within this framework, further detailing has to be carried out.

One of the most important aspects of this detailing process is to prepare urban design guidelines with special emphasis on the features which carry the essence and spirit of the galaxy plan, namely the Lines of Force, the Crown area, and the development along major roads to achieve a harmonious built environment.⁹⁰

On the issue of the sacred geometry of the Galaxy, there are good though not conclusive reasons to believe so. Mother’s exchange with Anger points in this direction – particularly, the channelling of Mother’s inspiration on Anger’s part, the alignment of the model with the natural, dynamic movement in the cosmos and the manifest power of Mother’s symbol, which she spoke of on several occasions. Symbols hold a living power, and though the Infinite Divine is not bound by them, they are helpful tools for ascension.⁹¹ Some have thus cogently argued that the Galaxy plan is an instrument or *yantra* – a geometric form to invoke the descent of higher grades of consciousness – that should not be distorted at human hands. That said, as we do not have any direct textual evidence in Mother’s words to that effect, divining her latent intentions or occult truths (especially claiming Divine truth to end debates) is a risky exercise that demands caution as we do not have privileged access to her vision. For example, we may confuse imagination for true inspiration or revelation, or read meaning into uncertain signs. Here, in line with the principle of ‘illuminated hierarchies’ outlined in Part I above, if there are members of the community who do speak to this issue from interiorized states of experience, their opinion should be accorded the greatest weight. At a minimum, all else being equal, every effort ought to be made to manifest Mother’s symbol in the urban design, which both Anger and Heymann recognized as the ideal.

Contrary to this view, some conversants argued along the lines that ‘if Mother was here, She would have changed the concept ...’ and noted that the Galaxy Concept is dated, reflective of the architectural and planning vision of the time when other grand city projects were being conceived (Chandigarh, Brasilia etc.). As we noted above, Mother’s approval of the planning mould of the city was not lightly made, subject to *basic* revision later, as opposed to flexibility with particular areas of implementation that were left open, which are abundant. She accepted the concept with *foresight*, addressing problems of village relations and resettlement, energy

⁸⁹ See, for example, Auroville Today, May, 2023; see also, Residents’ Assembly, General Meeting, August, 2022 for community discussion on this point.

⁹⁰ Masterplan Directions for Growth, 2003, 28.

⁹¹ This requires a fuller discussion which is beyond our scope here.

and water shortages, regional development, property speculation etc., and as such, anticipated future problems. One naturally cannot prove a negative, i.e., rule out the possibility that she would have changed the concept, but as all available textual evidence points otherwise, such a conclusion, *argumentum ex silentio*, seems unmerited. Mother's response in relation to a proposal for re-zoning may equally apply to revising other primary features of Galaxy Model:

Well I am not an architect or an engineer, I wrote what I saw. Now *it is up to you people to realise that*.⁹²

I have written what I saw; now it is *for you to realise*.⁹³

The Masterplan pre-empts such objections as well, noting the continued appeal of the Galaxy plan today:

This concept is as practical as it is visionary. The way in which this concept lends itself to international, national and local thinking is extraordinary. It is as modern today as it was innovative when it was expounded some thirty years ago. (Refer sketches) The concept envisions close interaction between Auroville and its surroundings to create a holistic model of development in which urban and rural settlements will complement each other and are not seen as separate. This concept is now being widely recommended to move towards balanced sustainable development.⁹⁴

In reflecting on this debate, we were not able to identify reasons that exist today that were not factored in at the time of Mother's approval, nor do the records contain an indication that she anticipated a basic revision. Quite the contrary – as Mother emphatically said, we may suppose anticipating delays through quarrelling:

To the architects and engineers – you are not here to discuss the project. You are here to build the city.⁹⁵

Naturally, circumstances on the ground have changed in the last fifty years (with socio-economic developments in the bio-region, a greened landscape with sensitive environmental hotspots etc.), but these are part of the anticipated process of development and not constitutional changes. In relation to the geometric form of the Crown and environmentally sensitive areas that overlap, all possibilities to explore the natural width designed in the Crown corridor (not just as a road, but more) can be explored for creative design solutions to maintain the overall geometry whilst weaving in environmental concerns – Nightingale, for example, points to such an approach.⁹⁶ As we discuss in Part III.A, several studies – the Land Suitability

⁹² Guigan, 2018, Vol. 2, 351 (emphasis ours).

⁹³ Guigan, 2018, Vol. 2, 352 (emphasis ours).

⁹⁴ Perspective Masterplan, 2001, para. 2.4.1.

⁹⁵ We were not able to locate this message in the Auroville Archives. We were informed that it was found in the Archives of the Sri Aurobindo Ashram. A photo of the original is available online, though without a date or reference. See, Auroville, the City the Earth Needs, 2019. It is also referenced by Majumdar, 2022.

⁹⁶ Auroville website, 2020. Again, our understanding in this area is limited, and as such, our discussion is informed by available documents and conversations with experts in Auroville well versed in the matter. Many of these conversants noted that the Crown can accommodate environmental concerns whilst preserving the symbolism encoded in the Galaxy if the natural width of the Crown is used as a design lever and the imagination of the Crown is expanded beyond a road-mobility network, which seems to be in line with Anger's proposal.

and Land Use Study, Crownway Study, Dreamweavers forum, Feduchi's Draft Proposal for Residential Zone Sectors 1 and 2, International Zone Strategic Plan etc. – offer solutions to integrate the Galaxy concept with ground realities.

At any rate, there will naturally be some loss of green cover in the area designated for the Crown in particular sectors (though the Masterplan zoning for the Crown covers less than 2% of the plan area). However, as long the overall ecosystem of the entire plan area (which stands at more than 50% green cover) is maintained, the important ecological imperative to work with nature can be preserved. As the Full Report of the 2015 Retreat notes, several plantations and constructions were made in earlier years with a view to land regeneration and servicing immediate needs of time, necessary at the point given the denuded condition of the land. If some of these need to give way to the needs of today for the next stage of growth, with appropriate relocation and alternate plantations to maintain the overall green-cover in a spirit of mutual accommodation for a shared city to develop, then that is part of the anticipated process. As such, the model of stewardship does not generate exclusive use or ownership rights over lands inhabited or worked upon, but equally, respect for those who laboured to develop and green the land, or have generated close links to it through long association, is important. The Terms of Reference of the Town Development Council, adopted by the Residents' Assembly in 2017, clarifies this point:

Relocation / rehabilitation can be offered in cases where there is a requirement to displace people in case of a conflict of land use. The extent of this needs to be defined. e.g. in which cases can it considered not necessary (for example, when someone has signed an agreement accepting temporary stewardship of the space). In all such cases, the wider interest of Auroville as an evolving township will override personal preferences or attachments.⁹⁷

The records show that a similar situation arose in Auroville's early days, when residents of the Silence community were requested to vacate for the development of other, collective projects. Mother's guidance at the time suggests that constructions legitimately made earlier, when plans were not at hand, may need to give way to 'suit the overall program' stewarded by those in-charge of organization (today the Working Groups), as long as it is done sensitively and with reason. This naturally involves discomfort and some sacrifice, but if dealt with in a spirit of fraternity, with alternates provided to them, it in the interests of the whole:

The residents of Silence will go on vacating their places for Bharat Nivas without causing any delay in the work. They will help in the quicker construction of the Matrimandir Workers Camp so that some of them can shift there and some will be accommodated in the huts on the border of Silence not immediately required for Bharat Nivas. These too will be vacated as soon as needed. The residents of Silence wish to set up some cottage industry like ceramics and tiles and live near Kottakarai village and work for the development of this village and better relations with the people of this village. A concrete scheme will be made by them in such a way as to

⁹⁷ TDC, Terms of Reference, 2017, para. 2.2.1.1.

suit the overall Auroville program in consultation with Shyam Sunder and Roger and placed before the Mother for approval and blessings.⁹⁸

Resolving this long-standing dispute – the ‘ecology versus geometry’ debate – to draft a common action plan is essential for city-development. We consider this in more detail in Part III.A. This will require a flexible, expert-driven and consultative (yet time-bound) process for the Detailed Development Plan for the City Centre / Crown (still lacking today, despite draft proposals by Kundoo, the Crownweaving and Dreamweaving initiatives among others) that *all* involved are ready to contribute to and abide by once decided. This is a priority task. As part of this process, an environmental audit to clearly determine which areas can be developed / replaced / rehabilitated through interventions elsewhere, and which are essential, can allow for this exercise to take place in an informed and time-bound manner.

In some cases, as we were informed by several discussants, there have been deliberate constructions and plantations to avoid the manifestation of the Galaxy.⁹⁹ If so, this naturally does not give reasons to modify the Galaxy Model but to state these facts publicly and remove those constructions urgently, sensitively (as time as passed since the original event, with a changed institutional and community memory) and peacefully, with community buy-in on all sides. Designated common spaces, such as those for the Cown, must be recognized as such:

All project holders will have the freedom to try out innovative developments as long as the basic parameters of the Master Plan (Perspective: 2025) are met. The Planning Group envisaged under the Master Plan (Perspective: 2025) will be in charge of ensuring that all future projects conform to these regulations.¹⁰⁰

In sum, as it appears from Mother’s words, the Galaxy concept – with the four primary (or five, including the Peace Area) zones, four intermediary zones and three essential integrative elements – forms part of the basic, non-negotiable spatial architecture of Auroville, within which the space for technical creativity, innovative design-thinking and flexibility is provided and indeed required. By all assessments, Ciconesi and Ciconesi, Anger, Doshi and others, this is a difficult task given complex ground realities – yet, that is, as Nightingale playfully suggests, the challenge Mother has set. The following remark by Mother, though made in a different context, seems to encapsulate the matter:

I am blaming nothing, nor anybody and know that each one does the best he can. It is evident that the job is very difficult. But are we not here to conquer difficulties?¹⁰¹

Records show that the debate on the Galaxy goes back at least thirty years and been a constant hindrance to decisive action. As such, as a practical matter, (i) given Mother’s express approval, and the absence of countervailing reasons today, and (ii) the flexibility and openness of the Galaxy concept, its acceptance and urgent work to manifest it can emerge from an overlapping consensus on particular projects to start with and need not be held hostage to agreement on all

⁹⁸ Guigan, 2018, Vol. 1, 268-9.

⁹⁹ See, for example, Auroville Tomorrow, 2022, 4. (‘It has become clear that a few people wanted to block the implementation of the master plan of Auroville. This was done by placing the Youth Center kitchen in the way of the Crown road.’)

¹⁰⁰ Masterplan, 3.1.2.

¹⁰¹ Mother, CWM, 2002, Vol. 13, 159.

counts.¹⁰² As we discuss in Part III.A, slew of studies commissioned by the TDC to blend the Galaxy plan with geophysical ground realities, with the latest Dreamweaving process in 2022 which attracted participation from all quarters and the encouragement of the Governing Board, have proceeded on this integrative basis with what appears to be a significant overlapping consensus.

*

¹⁰² See, Sunstein, 1995. Such ‘incompletely theorized agreements’ allow for decision-making and action amidst disagreement, preserving plurality and respect for opposing views, whilst building common ground through a network of small actions.

C. 'THE CITY THE EARTH NEEDS': AUROVILLE'S SPIRITUAL URBANISM

i. *The Urban Question*

Mother's vision of the New Creation, progressively realized and culminating with a gnostic society guided by the descent of the exalted Supramental, is Auroville's ideal. The question is of the spatial form within which this ideal is to embodied. Mother's view is not rural or ascetic, but urban and rich. Her response is clear:

The step which is being added now Sri Aurobindo has called the Supramental. It is a work in the consciousness, a work of connection between the Supermind and the material being ... Once however, the connection is made, it must have its effect in the outward world in the form of a new creation, *beginning with a model town and ending with a perfect world*.¹⁰³

The 'model town,' a precursor to a perfect world, must accept and transform in a microcosm all extant problems of human aggregates: 'a model for those who aspire for a better and higher collective life everywhere.'¹⁰⁴ Thus, Auroville's ideal must define its *problems* from what is happening elsewhere – it cannot avoid them, even if it presents an easier route. Its uniqueness lies in devising *solutions* to those problems, as a living research laboratory. This follows from Auroville's representative character – that it is symbolic of world-movements and their difficulties:

India has become the symbol representing of all the difficulties of modern humanity. India will be the land of its resurrection, the resurrection of a higher and truer life

And the clear vision: the same thing which in the history of the universe has made the earth the symbolic representation of the universe so as to be able to concentrate the work at one point, the same phenomenon is occurring now: India is the representation of all human difficulties on earth, and it is in India that there will be the ... cure. And it is for that – it is FOR THAT that I was made to create Auroville.¹⁰⁵

[Q: Is Auroville the only solution to the misery of mankind and the disorders of society?] Not the only solution. It is a centre of transformation, a small nucleus of men who are transforming themselves and setting an example to the world. This is what Auroville hopes to be.¹⁰⁶

This requires all challenges, including urban ones, to be faced in this microcosm. It is only so that Auroville can become the 'city the Earth *needs*,' and not necessarily one its residents may (legitimately) want as a matter of personal preference.¹⁰⁷ The purpose of Auroville is not defined by individual will or interest, but by the Divine's Will manifest through Mother's words.¹⁰⁸ As Mother noted:

¹⁰³ Mother, CWM, 2002, Vol. 3, 178 (emphasis ours).

¹⁰⁴ Guigan, 2018, Vol. 1, 228.

¹⁰⁵ Guigan, 2018, 1, 237.

¹⁰⁶ Guigan, 2018, Vol. 2, 433.

¹⁰⁷ Guigan, 2018, Vol. 2, 433.

¹⁰⁸ This sentiment was often expressed in our conversations. As one early resident noted, representative of debates at the time: 'we can't change the whole master plan [referring to the Galaxy Model] can we? The chief-

None of us are here to ‘do as we like’, or to create a world in which we shall at last be able to do as we like; we are here to do what the Divine wills and to create a world in which the Divine Will can manifest its truth.¹⁰⁹

Put another way, Auroville’s spiritual mission – the Divine Will manifest through Mother’s vision – is cast into a concrete spatial form, an urban environment or ‘city,’ which is its material mission. This reflects a synthesis of the material and the spiritual which, as we noted above, is the centrepiece of Mother and Sri Aurobindo’s work. This view is reflected in the context of Auroville, for example, in Mother’s letter to the Ford Foundation dated 13th March 1969, which we discuss below. Mother sets out Auroville’s urban mission thus:

In a way at Auroville all the problems of urbanization will be faced *at the very outset* ... Similarly, over time as industrialization progresses with the development of the country, urbanization will also continue increasingly within the country – presenting complex town planning problems, which have to be resolved. It is here that the researches and applications of systems engineering at Auroville *can contribute* a wealth of material in *solution of problems* related to the development of complete townships, and partly to the existing towns.¹¹⁰

This passage makes it clear that Mother’s vision of Auroville came amidst an inflexion point in urbanism, and must therefore, be understood within that context. The letter situates Auroville as an exemplar of an urban environment, not as an exception to it, such that other townships can learn from it. Equally, the letter emphasizes the urgency of the task, noting that urban issues are to be dealt with *at the very outset*, anticipating problems that were to arise during India’s development. This raises the question: what are defining features of an urban environment?

ii. *A Sketch of Auroville’s Urbanist Aspirations: Harmony in Density*

We can reconstruct an answer to this question from three sources: Sri Aurobindo’s *Ideal of Human Unity*, Anger’s interactions with Mother and a brief overview of contemporary urban studies literature, read with the Perspective Masterplan 2025 and the ‘first master plan’ of 1968.

a. *Dense City-States in Sri Aurobindo’s Thought*

Though Sri Aurobindo does not discuss urbanism by name, the *Ideal of Human Unity* discusses the question of agglomeration and association of human aggregates, which bears on this question. He notes:

... in this organisation of nations and kingdoms those which have had the most vigorous life have gained it by a sort of artificial concentration of the vitality into some head, centre or capital, London, Paris, Rome. By this device Nature, while acquiring the benefits of a larger organisation and more perfect unity, preserves to

architect, Roger, has done it in consultation with the Mother. After Mother’s approval he has done it. The execution has been decided. Now the whole thing can’t change.’ Guigan, 2018, Vol. 1, 168-9. That said, while the essential purpose, the constitutional cast, of Auroville is defined by Mother’s words, the details of the manifestation and crucially, evolution within that broad framework are not only required but anticipated. This requires significant choices to be made where direct guidance is *not* to be had in the text, but in the continuing, if veiled, presence of the Mother, if the collective yoga can access it.

¹⁰⁹ Guigan, 2018, Vol. 1, 139.

¹¹⁰ Mother, 1969 (emphasis ours).

some extent that equally precious power of fruitful concentration in a small space and into a closely packed activity which she had possessed in her more primitive system of the city state or petty kingdom. But this advantage was purchased by the condemnation of the rest of the organisation, the district, the provincial town, the village to a dull, petty and somnolent life in strange contrast with the vital intensity of the *urbs* or metropolis.¹¹¹

This ‘vital intensity’ of the *urbs*, reflected in early city-states, reflects an urban concentration, ‘closely packed with activity.’¹¹² Nature’s experiment, which forms the ideal of Auroville, is an attempt at synthesizing two opposites, the urge to unite distinct and sporadic elements whilst retaining their diversity and creativity, all within a ‘small space.’ The question, one may infer, is one of managing population densities. As Sri Aurobindo notes, though in a different context of the Roman empire, this organization must navigate the conflicting impulses of individualism and collectivism:

The advantages are admirable organisation, peace, widespread security, order and material well-being; the disadvantage is that the individual, the city, the region sacrifice their independent life and become mechanical parts of a machine; life loses its colour, richness, variety, freedom and victorious impulse towards creation.¹¹³

This vitality of city-states is an experiment in living intimacy, subject to the hazards of congestion and uniformity, and free variation, subject to the dangers of an urban sprawl and disorder. Sri Aurobindo’s thought recognizes this play of integration and dissipation at several points, both ontologically in the *Life Divine* and socially in *Ideal of Human Unity*. He notes:

In life also the Consciousness-Force begins with infinitesimal forms of vegetable life and infinitesimal animalcules; it creates an original plasm and multiplies it, creates the living cell as a unit, creates other kinds of minute biological apparatus like the seed or the gene, uses always the same method of grouping and association so as to build by a various operation living organisms ...¹¹⁴

As Life here establishes and maintains its operations with difficulty on a foundation and in an environment of general Death, first in infinitesimal points of life, in quanta

¹¹¹ Sri Aurobindo, CWSA, 1997, Vol. 25, 283.

¹¹² This discussion is not to be confused with the idea that Auroville will have an extra-territorial status, a proposition floated by Mother, yet never worked upon seriously. Interestingly, as Sri Aurobindo discusses Paris and London, rough estimates indicate that the population density of London and Paris in 1921 (right after the publication of the *Arya*) was 380 and 276 persons per hectare respectively, far higher than averages today. He also discusses at length the Greek city-states and Italian collectives: estimates vary, but range between 150-200 persons per hectare. As a matter of historical interest, Bairoch notes that in Greek city-states ‘as a general rule, as soon as a city approached a population of 20,000 – 30,000, it decided to found a new city rather than to continue the original city’s development.’ He quotes Plato’s discussion on this point, for whom ‘the ideal republic would have 5,040 citizens. If one interprets citizen as being equivalent to head of household, this implies a population on the order of twenty thousand people ... He argues, then, for cities of very restricted size. But his concept of the city remains ambiguous in that the ideal republic in his system depends on the integration of the rural and the urban, thus blurring the distinction between them. In any event, for Plato and Aristotle, by far the most important criterion for determining the size of cities is political in character, and it is intimately linked with the problem of communication. The city must remain sufficiently small to permit the holding of public meetings with all of the citizens present.’ Bairoch 1991, 74-6. Studying historical urbanization practices is an interesting historical research task for Auroville’s research landscape.

¹¹³ Sri Aurobindo, CWSA, 1997, Vol. 25, 283.

¹¹⁴ Sri Aurobindo, CWSA, 1997, Vols. 21-22, 862.

of life-form and life-energy, in increasing aggregates that create more and more complex organisms, an intricate life-machinery ...¹¹⁵

The administrative, political, economic organisation of mankind in aggregates of smaller or greater size is a work which belongs at its basis to the same order of phenomena as the creation of vital organisms in physical Nature ... To build a strong and durable body and vital functioning for a distinct, powerful, well-centred and well-diffused corporate ego is its whole aim and method. In this process, as we have seen, first smaller distinct units in a larger loose unity are formed; these have a strong psychological existence and a well-developed body and vital functioning, but in the larger mass the psychological sense and the vital energy are present but unorganised and without power of definite functioning, and the body is a fluid quantity or a half-nebulous or at most a half-fluid, half-solidified massed plasm rather than a body. This has in its turn to be formed and organised; a firm physical shape has to be made for it, a well-defined vital functioning and a clear psychological reality, self-consciousness and mental will-to-be.¹¹⁶

In building collectives, there is, as Sri Aurobindo notes, a *progression* from small, discrete units coming together in time in a ‘larger loose unity’ – a nebulous arrangement to begin with – leading to a firm shaped through an organized process of integration. Spatially, this translates into a ‘firm physical shape’ for this vital concentration, i.e., urban environment with a critical density. Sri Aurobindo in fact notes that had the old city-states endured to ‘create larger free aggregates without losing their own life in the new mass’ – a challenge they could not meet – many problems ‘might have been solved with a greater simplicity ... which we have now to settled in a complex and cumbrous fashion ...’ Auroville, the modern *avatar* of the city-state, is tasked with solving this problem.

As we discuss in Part IV.A, an important governance issue in Auroville today is how to bring together the loosely organized mass of customs developed over its early years as a response to the needs of the time into a ‘carefully thought-out law and ordered regulation,’ a question of unified living in a high-density framework: in short, how ‘intelligent organisation replaces natural organism.’¹¹⁷

b. Mother’s Consideration of the Urban Challenge

Mother’s description, particularly in conversations with Anger, bear a close resemblance to Sri Aurobindo’s discussion on city-states and emphasizes the urban element, explicitly affirming the need for high population densities.

In a 1965 document sent by Anger to Mother, he had suggested that Auroville should avoid ‘the trap of a city cold (sic) because it feels like a desert due of excessive separation,’ and address this ‘difficult problem of urban grouping’. To this, Mother tellingly replied, ‘very important.’ Similarly, Anger noted:

.... [what should] also be avoided the trap of a city cold because it feels like a desert due of excessive separation. It is indeed essential very important not to create a city

¹¹⁵ Sri Aurobindo, CWSA, 1997, Vols. 21-22, 310.

¹¹⁶ Sri Aurobindo, CWSA, 1997, Vol. 25, 366-7.

¹¹⁷ Sri Aurobindo, CWSA, 1997, Vol. 25, 462.

that would be too scattered. What one has to reflect on and succeed in dealing with it is the difficult problem of urban grouping and thus avoid falling into the trap of ‘dormitory-towns,’ of known new towns and of large American ‘individual’ housings areas.¹¹⁸

Here, the Mother underlined the phrase ‘avoid falling into the trap,’ marked the last two sentences and commented: ‘Very important.’ Elsewhere, Anger remarked on the play of integration and independence for Auroville’s residential areas:

The manner in which the homes will be treated plays an essential role in the image of Auroville ... It is therefore necessary to re-discover urban warmth by creating contacts as permanent as possible between residents, while still making it possible for them to withdraw completely.¹¹⁹

In an interview given at around that time, where Anger’s creative inspiration is on display, he paints an unmistakably urban environment – with a concentration of commerce, markets, public spaces, both silent and with recreational activity, hotels, sports grounds, all blended in an aesthetic exquisiteness, in which ‘redensification is today’s necessity’:

The ring [later the Crown] – itself encircled by a hundred metre-wide canal where artificial islands will provide a rhythm, a dwelling place for various aquatic birds, where 21st century gondolas will leisurely circumnavigate – will be the intersection of all sectors, the town’s centripetal focus. This is where, in addition to the fairy-like charm of canals, the main commercial centre will be located. Here one will find theatres, sports grounds, recreation halls, gardens for meditation, forums for meetings, hotels ... visitors galore, of course, since Auroville is not a closed town, but a town open to the world and the urbanist [town planners] must never forget this essential openness.

...

We are approaching the ring and the canal of the Great Curve where thousands of waterfowl play freely, and we go over one of the town’s few bridges. As in a fairy-tale, we start climbing intriguing staircases rising and turning so softly and capriciously against the sharp edges of great terraces that one may promenade for hours, contemplating all the faces of the town. Strolling along covered passages we discover handicraft makers and artists holding continual exhibitions; we play hide-and-seek with light and shadows, with activity and tranquillity, stopping at last at the edge of a sculptured open space. At the foot of this regal balcony, on the inner side of the ring, stretches the Garden of Unity, encircling a shining lake whose running waters supply Auroville’s canals, waterfalls, fountains and paddy-fields. From this lake rises a symbol of all manifestation, the intersection of all intersections, an unattainable white and golden island, burning like a high flame. This is the centre of Auroville, not a geometrical centre, but the core around which the ring gravitates in two waves, two helicoid movements trying to catch each other like Yin and Yang, like two facing complementary galaxies, a symbol of Auroville’s deepest dynamism.¹²⁰

¹¹⁸ Anger, 1969.

¹¹⁹ Anger, 1969.

¹²⁰ ‘=1’, 1968.

Similarly, we may look to the 1956 brochure for the ‘New Horizon International’, which was part of the Sri Aurobindo International University Centre, a precursor to Auroville, that had Mother’s blessings. Here, the idea was to be ‘modern in every respect’, with provisions for urban amenities:

Designed and landscaped with an eye to the aesthetic, this residential community will be modern in every respect, including among other amenities: a non-sectarian temple for worship; recreation areas for swimming and other sports; playgrounds for children; indoor recreation and dining halls; community administration offices; health facilities; schools and grounds; a cinema; a modern shopping centre; cold storage and food processing plants; bakery; community laundry; water works; electric power plant; maintenance buildings; sewage disposal plant; general air conditioning.¹²¹

Finally, and importantly, Anger’s density proposal of September 1965, which Mother approved, envisaged approximately 40000 inhabitants per square kilometer and 7500 accommodations per square kilometer, with an average house plot size of 300 square meters, in the Residential Zone.¹²² As we note below in comparison with other cities, these are relatively high-density figures that point again to Mother’s core vision for a lively and bustling urban environment, not a semi-urban or rural settlement: population density is an all-important urban marker, and a major problem to be solved insofar as Auroville is to serve as a model for others. As we note in Parts II.A and B, the question of densities has been a major hurdle in planning discussions that needs urgent attention.

c. Characteristic Markers of Urbanism: Benchmarks for Auroville

Six key features emerge defining an urban environment in contemporary urban studies literature: (i) population density, (ii) increased productivity and agglomeration benefits, (iii) scarcity of resources and distributional conflict, (iv) migration, plurality and heterogeneity, (v) rural-urban linkages, and (vi) sustainable development, ecological and aesthetic concerns.¹²³ Each of these is explicitly mentioned by Mother, in wise anticipation of characteristically urban problems.

A nascent and insightful literature on urbanism in Auroville has emerged in the last few years.¹²⁴ A fuller examination of this literature and urban studies scholarship in general is necessary, but beyond our scope here. We enter a brief discussion to mark some important features to understand Auroville’s urban future.

1. Population Size and Density

¹²¹ Guigan, 2018, Vol. 1, 59. Two years earlier, in 1954, Mother referred to an ideal city with two thousand residents, which would be ‘built according to the most modern plans.’ Guigan, 2018, Vol. 1, 48.

¹²² Guigan, 2018, Vol. 1, 122, fns 1, 4. *See*, Part III.C below for some discrepancies on these figures.

¹²³ We do not mean to enter the debate on the criteria for defining urbanism, but simply to identify some characteristic features. *See*, for a fuller discussion, Bairoch, 8 *et. seq.*; at p. 21, the discussion on the important comment that ‘the chief distinguishing feature of cities, and especially of cities in traditional societies, is their individuality.’ This is particularly true for Auroville. The Masterplan recognizes this. *See*, Masterplan, para. 1.6.1.

¹²⁴ *See*, for example, Woiwode C and Bhati, 2018; Venkataraman et. al., 2022; Walsky, et. al., 2013. We may note here that the ‘eco-village’ characterization in some literature is worrying.

First, rapid urbanization is a clear and defined trend globally, as the letter to the Ford Foundation anticipated in defining Auroville’s ideal.¹²⁵ Urban populations across the world have increased from 36% in 1968, the year of Auroville’s founding, to 55% in 2017,¹²⁶ with projected increases to 67% by 2050. This translates to a 340% increase in absolute numbers in urban residents over the last half century. In India, as a proximate example, the number of towns grew from 5161 in 2001 to 7935 in 2011, accounting for a 50% urban growth rate. Similarly, the urban demographic grew in China from 17.9% in 1978 to 58.52% in 2017.¹²⁷

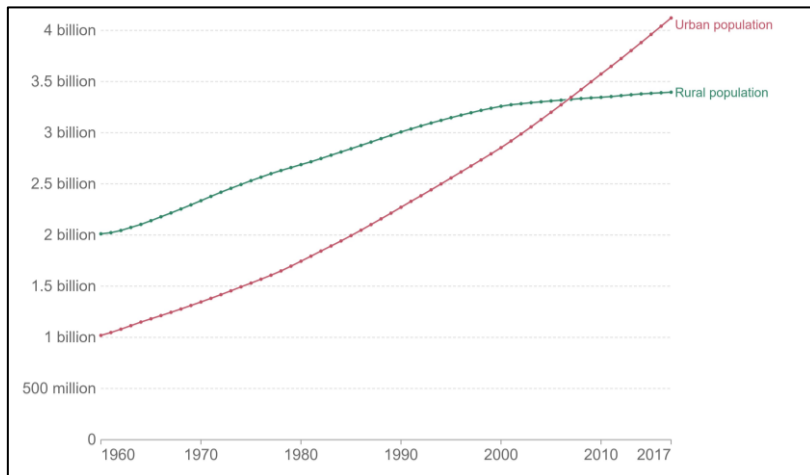

(Urban population trends. *Source:* Our World in Data, 2019)

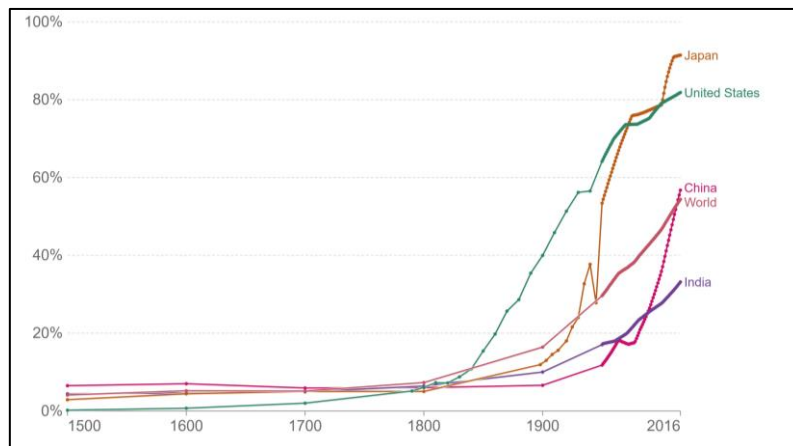

(Share of Total population living in urban areas. *Source:* Our World in Data, 2019)

¹²⁵ Mother, 1968.

¹²⁶ Ritchie and Roder, 2019.

¹²⁷ Jiang et. al., 2019, 652; *see also*, Fang et. al., 2016.

This trend is likely to continue, particularly in Asia and Africa, in Fragkias’ synthesis of global urbanization projections:

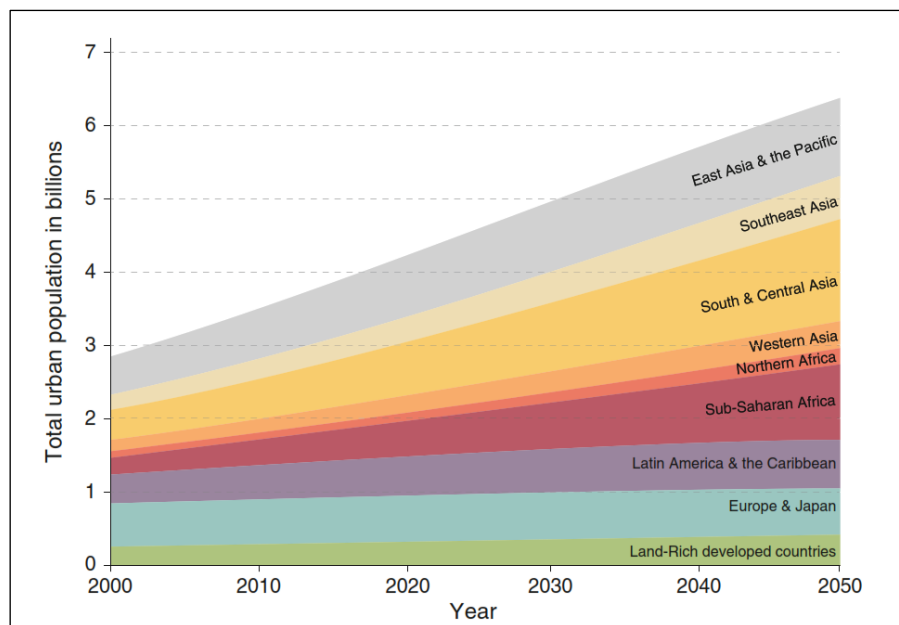

(Urban population projections for different world regions. *Source:* Fragkias et. al., 412)

Second, this shift is marked by a rise in population densities. As Bairoch notes in his examination of urban evolution, cities are defined by a ‘population of sufficient size and, above all, density.’¹²⁸ The United Nations ‘World Urbanization Prospects’ programme similarly defines the term ‘urban agglomeration’ as a

population contained within the contours of a contiguous territory inhabited at urban density levels without regard to administrative boundaries.¹²⁹

The Organization for Economic Co-operation and Development (‘OECD’) divides the causes of increasing urbanization into three buckets, each demonstrating increasing densification given data since 1975: growth of existing townships into cities, lateral growth of existing cities and increased densities within existing cities. Interestingly, the OECD considers 50,000 as the threshold for this occurrence, placing Auroville’s maximum population at the city threshold.

Globally, the population density of cities has grown since 2000 practically everywhere, due to widespread population growth. In general, the growth of the city population can occur in three ways. First, new cities can emerge from towns and other smaller settlements by reaching a population of at least 50 000 inhabitants. Second, cities can expand through the emergence of new dense neighbourhoods at their edge. Finally, city population can grow through densification within existing city boundaries (i.e., densification). Over the last decades, the city densification has gained further importance as the main source of city population growth [see figure

¹²⁸ Bairoch, 1991, 24, 454.

¹²⁹ Department of Social and Economic Affairs, United Nations, 2018.

below]. Between 1975 and 1990, densification accounted for 50% of the global city population growth, while its contribution increased to 60% in 2000-15.¹³⁰

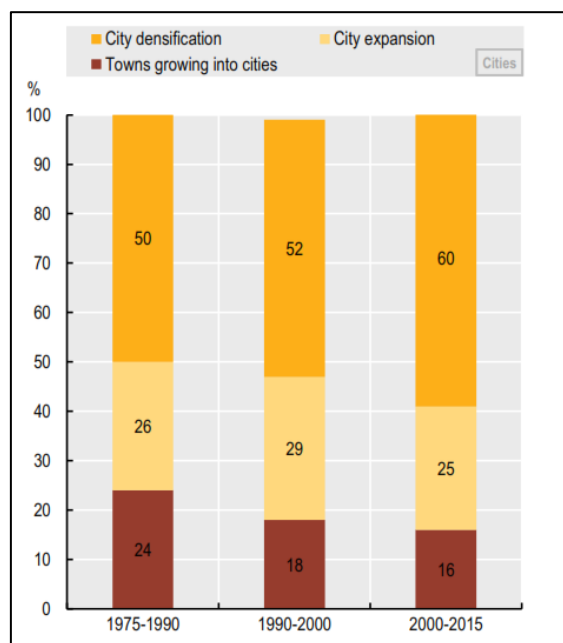

(Sources of Population Growth, 1975-2015. *Source*: OECD 2020b, 103)

In terms of absolute numbers, 16% of the population in India lives in agglomerations of more than 1 million, up from 8% in 1960. Globally, this figure has increased by approximately 9% from 14.13% in 1960 to 24.62% in 2021 – the increase being markedly higher in low to middle income countries. The average population density of the hundred most prominent urban settlements across the world in 2014 was 74.5 persons per hectare, with a median of 61 persons per hectare.¹³¹ In India, again as an example, taking the 2011 National Census, the average population density of an urban settlement was 35 persons per hectare (a relatively low figure), with more than two-thirds living in towns with over 100,000 residents.¹³² As the OECD notes, as of 2020,

On average, cities in low-income countries have the highest densities in the world, close to 10000 inhabitants per km² compared to 7200 in lower-middle-income countries, 5300 in upper-middle-income and only 2800 in high-income countries [100, 72, 53 and 28 persons per hectare, respectively]. These differences in population density are also noticeable by world regions. In North America, the world region with the lowest density, cities have on average 1700 inhabitants per square kilometre, which is significantly lower than in the second least densely populated region, Europe, where cities have close to 4000 inhabitants per square kilometre [17 and 40 persons per hectare, respectively]. In contrast, cities in South Asia and Sub-Saharan

¹³⁰ OECD, 2020b, 102.

¹³¹ We have calculated the average from datasets available at Our World in Data, 2014.

¹³² We take the average of ‘census’ and ‘statutory’ towns. *See*, Population Finder, Office of Registrar General and Census Commissioner, Ministry of Home Affairs, Government of India, 2011.

Africa are the most densely populated, with an average of 8000 inhabitants per square kilometre.¹³³

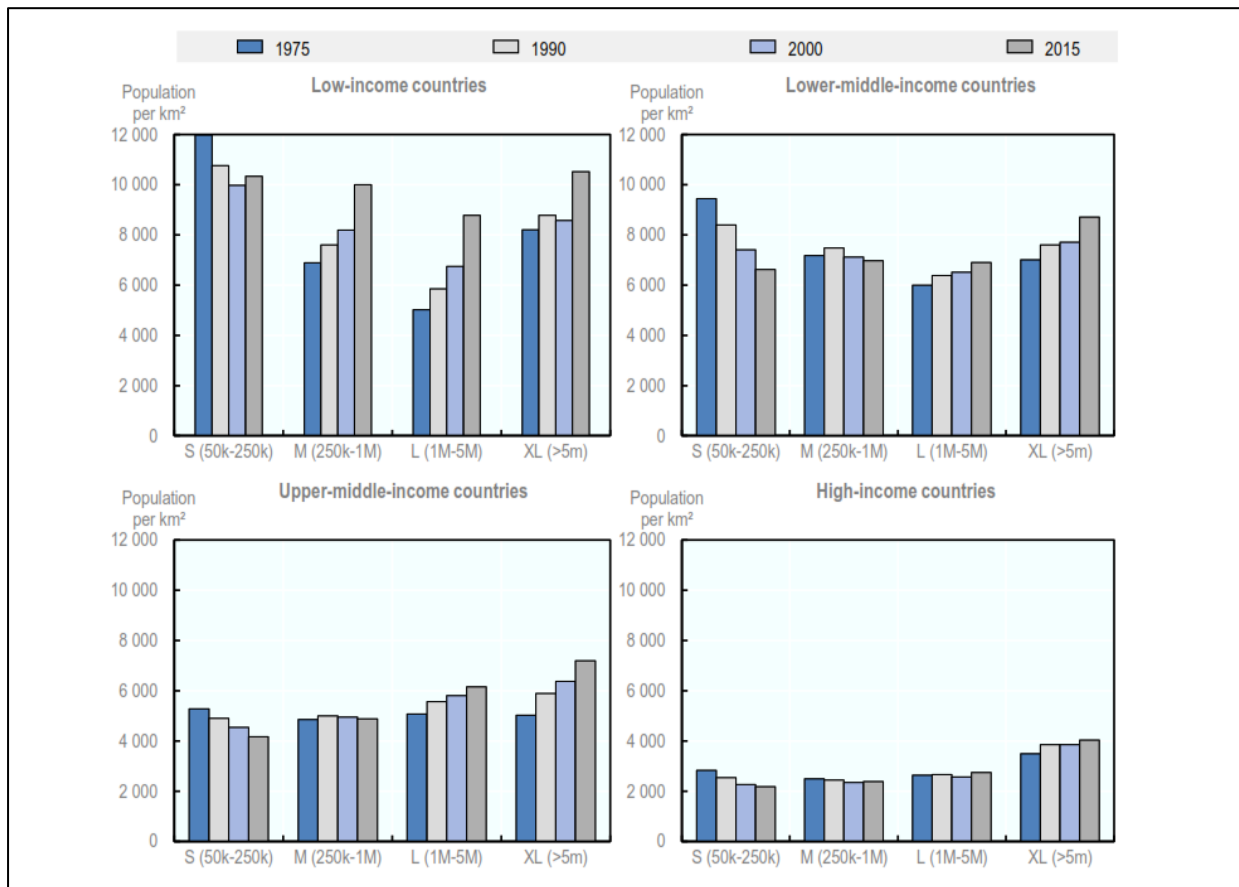

(Population Density by City Size and Income. *Source: OECD, 2020a, 141*)

In comparison, Auroville’s maximum population density at 50,000 residents will be 33 persons per hectare (including the Green Belt), and its current population density is 1.4 persons per hectare.¹³⁴ We consider the question of slow population growth rates, and their impact on Auroville’s urban aspiration, in Parts III.A and IV.E below. The regional context of Auroville, available as of 2001, records the density contrast.

¹³³ OECD, 2022b, 102 (inline comments ours).

¹³⁴ The updated Register of Residents was not available to us at the time of writing – we have guesstimated a population of 2750 as the average of the ranges communicated to us, though Suhasini et. al., estimate it at 3073 for 2019. The density figures can be re-calculated accordingly. Neither figure includes the population of the villages within the Masterplan area. These ought to be added, but we were unable to locate reliable data. Ideally, for reasons we note below, it would be helpful to calculate densities separately for the city area, the Auroville urban agglomeration (including the Green Belt and villages in the plan area) and neighbouring bio-regions (to be defined), to get a more textured understanding of the urban demographics, which will assist in appropriate planning policies. As we note in Part III, the quality of demographic data in Auroville appears to be poor, which affects proper assessment and planning – we propose an Auroville and bio-regional survey, to be conducted by the proposed Data Services group in Part III.

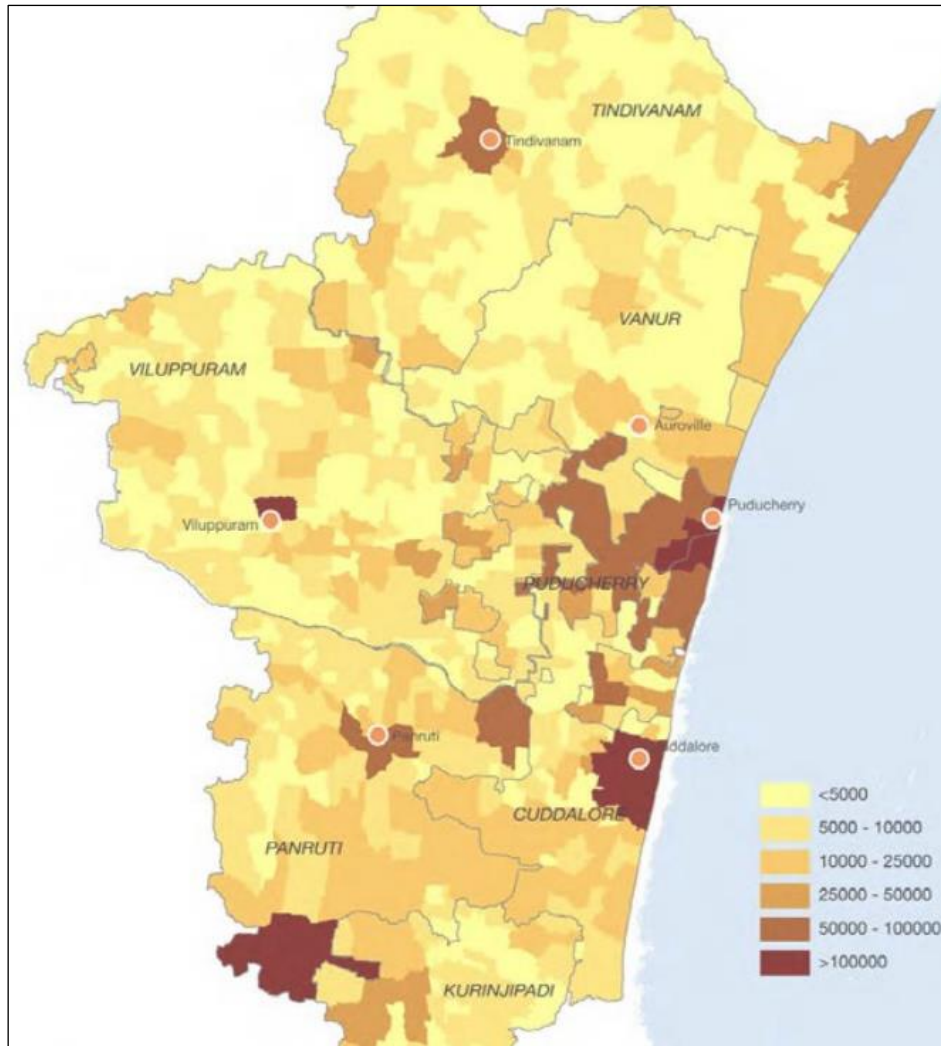

(Population distribution, 2001. *Source:* Kalra et. al., 2012, 39. As of 2011, Pondicherry and Cuddalore, the two closest urban agglomerations, operate at 2900 and 704 persons per sq. km. as of 2011, and the Villupuram District, predominantly rural, has 481 persons per sq. km.)

For Auroville to develop a new urban archetype, population density is a constitutive feature. This is important because consequences flow both in terms of benefits and challenges that urban environments characteristically face. The idea is not to increase density for its own sake, or to invite problems, but rather, to be representative of urban settlements for which Auroville is to serve as a model.¹³⁵ At its current density, Auroville is a proto-urban settlement, that does not admit of problems faced by other mid-sized urban aggregates identified below. As such, it cannot be a model for them in this regard. The maximum density of 33 persons per hectare will be in the average range of urban settlements – this does not include the local village or peri-urban population, which will drive up the figure fairly close to the median by our guesstimate.

National definitions of what constitutes an ‘urban’ area are divergent:

¹³⁵ See, Majumdar, 2017, 229-230 for a short discussion on this point.

There is currently no universal definition of what ‘urban’ means. The UN reports figures based on nationally-defined urban shares. The problem, however, is that countries adopt very different definitions of urbanization. Not only do the thresholds of urban versus rural vary, but the *types* of metrics used also differ. Some countries use minimum population thresholds, others use population density, infrastructure development, employment type, or simply the population of pre-defined cities.¹³⁶

That said, if we take three reasonably representative and well-articulated definitions, (i) the definition of a ‘census town’ in the Indian National Census of 2011 (5000 inhabitants or more with at least 4 inhabitants per hectare), (ii) the OECD’s 2020 definition of a ‘functional urban area’ (a cluster of contiguous high-density grid cells with a population above the population threshold of 50,000 with more than 15 persons per hectare), (iii) the United Nations Habitat Project’s 2020 definition of a ‘city’ using built up area density,¹³⁷ Auroville does not yet classify as a city. Applying the OECD’s regional typology chart, Auroville will qualify at its current levels as a ‘predominantly rural area’ (and not ‘intermediate’ or ‘semi-dense’), unless it is considered part of the Pondicherry urban agglomeration.¹³⁸ The precise definitional threshold may not be as relevant here as the core point that Auroville does not yet possess urban characteristics per the OECD’s definition (or others). As we note below, this is not a target to be achieved without reflection, but a reasonable standard to assess whether agglomeration benefits and challenges that flow from this minimum density threshold are in play, given Auroville’s representative character.

The early vision, interestingly, anticipated greater densities and was fairly detailed in this respect – the ‘first masterplan’ of 1968 outlined the following.¹³⁹

<i>Zone</i>	<i>Area in Hectares</i>	<i>Residing Population</i>	<i>Density (persons per hectare)</i>
Residential Zone A	31	17672	570
Residential Zone B	26	10107	388
Residential Zone C	26	8020	308
Residential Zone D	25	4486	179
Residential Zone E	28	2800	100
Residential Service Zone	17	1400 (*working population figure)	82
Average residential density: 281 Average working population density: 82			
Cultural Zone – University and Research	67	5000	75

¹³⁶ Ritchie, 2018.

¹³⁷ UN Habitat, 2020, 3.

¹³⁸ OECD, 2021. This is will require information on links between Auroville and Pondicherry; from our understanding that there is a limited flow of people, services and goods between the two at this point, this seems unlikely. In any case, this points to the importance of bio-regional planning with neighbouring urban centres, as discussed in the INTACH-PondyCan Report. *See*, Part III.C below.

¹³⁹ The drafting history of this document, and whether it was approved by Mother, is unclear. In any case, it is a useful historical benchmark.

Cultural Service Zone	5	700 (*working population figure)	140
Average residential density: 75 Average working population density: 140			
Economic Low Zone	64	5000 (*working population figure)	78
Economic High Zone	10	5600 (*working population figure)	56
Economic – Technical College	11	-	-
Economic Service Zone	9	700 (*working population figure)	78
Average residential density: NA Average working population density: 120			
International Display Zone	67	2000	30
International Zone University of Peace	6	3000 (*working population figure)	500
International Service Zone	8	700 (*working population figure)	87
Average residential density: 30 Average working population density: 264			
Administration	8	1500 (*working population figure)	187
Green Area – Residential – Cultural	30	- (green buffer)	-
Green Area – Cultural – Economic	34	- (green buffer)	-
Matrimandir Complex	30	- (zone of silence)	-
Green Area - International	8	- (green buffer)	-

(Population spread and densities under the 1968 Masterplan. *Source*: First Masterplan, 1968, 12-3)

Interestingly, in Heymann’s aptly titled talk ‘the Urbanism of Auroville’ at UNESCO at the time, he notes that ‘4 zones – two of high and two of lesser density’ are ‘*givens*.’¹⁴⁰ He references Varanasi as a ‘good example of the compact ... urbanism,’ and then says in unambiguous terms:

It should be noted that the notion of density in cities seems to be an *essential factor* of urban life in all climates.

¹⁴⁰ Heymann, 1966 (emphasis ours).

...

From our research we have identified general urban principles that can serve as a base to study this project of synthesis. 1. Structure of the urban fabric at a high density following traditional cities ...¹⁴¹

The density ranges in (i) Anger's proposal approved by Mother, (ii) the 1968 masterplan plan and (iii) contemporaneous testimony are thus far higher than current levels. Anger's caution to avoid an urban sprawl that Mother specifically underlined and approved is reflected in Auroville today – this issue of sub-optimal utilization of land is now recognized across the board,¹⁴² and is a major concern for Auroville, as we discuss in Part III.A. The question of optimal (and quality) density is one for deliberate planning policy on Auroville's appropriate demographic future, informed by developments elsewhere.

Interestingly, the United Nations Report of the International Conference on Population and Development in 1994 noted a trend towards *smaller* collectives:

... there are already signs of a changing pattern of population distribution, in the sense that the trend towards concentration in a few large cities is giving way to a more widespread distribution in medium-sized urban centres. ... This movement is also found in some developed countries, with people indicating preference for living in smaller places.¹⁴³

Some estimates support this view today:

In addition to these megacities [with a projected population of 630 million], about 400 million people will live in cities of 5-10 million people, and just over 1 billion people are expected to be living in cities of 1-5 million. However, most of the world's urban population will still live in cities of less than 1 million people.¹⁴⁴

While we expect increasing numbers of megacities (i.e., cities with population of over ten million people), they are expected to contain approximately the same proportion of the world's urban population – around 15 %. The majority of future urbanites will live in rapidly growing medium-sized or small developing-world cities, subject to many present-day urban pathologies.¹⁴⁵

If these projections hold, Auroville will be well positioned with its maximum population and density to serve as a model for these cities in the future. Interestingly, Anger hints at this view – 'I think it [50,000] was the number required for the experiment to have a complete reality.'¹⁴⁶

¹⁴¹ Heymann, 1966 (emphasis ours).

¹⁴² See, for example, Niti Aayog, 2021, 10; Quito Declaration, 2016, para. 13: 'Inadequate planning practices: ... Difficulties in regulating the growing demand for land in a fast-urbanizing world create urban sprawl and uncontrolled peri-urbanization processes. A common reaction among municipal governments has been to attempt to regulate peri-urban areas with traditional urban planning instruments. However, such tools have proved incapable of dealing with the complexity of fragmented space distribution processes, which in turn affect socioeconomic and environmental sustainability. The result is uneven development between centrally located urban spaces and those positioned in peri-urban interfaces.'

¹⁴³ Report on the International Conference on Population and Development, 1995, para. 9.1.

¹⁴⁴ ESPAS Ideas Paper Series, 2020, 1.

¹⁴⁵ Seto et al., 2011, 412-3.

¹⁴⁶ Majumdar, 2017, 236.

2. *Agglomeration Dynamics*

Urban settlements are usually accompanied by agglomeration benefits and challenges, both in cultural and economic terms. Economically, the dynamism of urban centres is well-recorded, with urban economies generating more than 90% of global Gross Value Added.¹⁴⁷ This including high-density economic activity on the back of productivity increases due to technological and scientific innovation, in turn driven by the specialization of labour, shorter trade and transit links and better utilization of human capital and shared infrastructure.¹⁴⁸ The literature on the effects of high density clustering is complex, and as Auroville proceeds, its systems design and experience presents a fertile area for research and innovation. We discuss this in the context of Auroville's housing and economic setup in Parts IV.D and F, where these dynamics are not yet activated with a relatively dissipated organization.

These issues were discussed, albeit briefly, by Mother, who refers to the benefits of scale at one point and Sri Aurobindo, who addresses the importance of the proper organization and coordinated economic growth to avoid the pitfalls of being too small.¹⁴⁹ He also hints at the evolutionary mechanics of the division of labour, and the need for specialization, key to the urban political economy, but does not consider the issue in detail:

The settled state of society and the expansion of the community which a more prosperous and stable life brings with it, involve an increasing complexity of the social organization. Specialization of function becomes pronounced, for the larger needs of the community demand an increasing division of labour. Rank and private property begin to emerge; inequality has begun. The more various activities, the more varied experience, the less primitive range of desires and the need of a wider knowledge of things and men create a greater mental alertness and increased mental differentiation. This in its turn means the growth of individuality.¹⁵⁰

The complex links between economic productivity and urban development have been discussed at length in the literature. Whilst increasing productivity generally leads to urbanization, the causality does not necessarily run the other way; nor is urbanization necessarily an unmitigated good.¹⁵¹ Chen et. al. identify the problematic, relevant to Auroville's own urban design and as importantly, to regional planning, insofar as policies for conscious urbanization / development of spatial form must proceed apace with quality productivity increases:

Industrialization leads to the direct output of economic growth, which further gives impetus to a vigorous process of urbanization in both developed countries and newly industrialized ones, mainly via a specialization of labor and the unprecedented development of non-agricultural sectors ... Numerous studies have previously found that the level of urbanization is closely correlated with the level of GDP per capita. It is generally accepted that economic growth promotes the expansion of modern

¹⁴⁷ Fragkias, in Elmqvist et al. (eds.), 2013, 409.

¹⁴⁸ See, for example, Lehman, 2019, 79.

¹⁴⁹ See, Guigan, 2018, Vol. 2, 72. ('Well, now there are thirty of you, it is difficult, isn't it? When there are thirty thousand of you, it will be easier because, naturally, there will be many more possibilities.'). See generally, Sri Aurobindo, CWSA, 1997, Vol. 25, 445-50.

¹⁵⁰ Sri Aurobindo, CWSA, 1997, Vol. 17, 288.

¹⁵¹ See, for example, Zhang, 2016.

industries and an increase in the urban population; in turn, urbanization also promotes economic growth to some extent.

Much of the literature on the urbanization process and the pronouncements of policy-makers have both hailed growing urbanization as a sign of progress. However, the essence of this interaction is something quite different and more complex. Our understanding of cities is being transformed and, via the new disciplines of complexity science and self-organization theory we now see them as biological systems rather than as mechanical systems. Cities have a strong sense of order and pattern, and are no longer regarded as being disordered systems beneath the apparent chaos and diversity of urban spatial form. Urbanization and urban concentration have a positive impact on economic growth while urban primacy has a negative impact. The argument that urbanization promotes economic growth has recently been challenged by a report showing that there is no evidence that urbanization level affects economic growth rate. This research highlights the importance of re-examining the relationship between urbanization and economic growth, and makes us rethink profoundly the popular ideas and practice of accelerated urbanization in developing countries. More recently, Turok and McGranahan have also argued that it is not urbanization or city size *per se* that induces economic growth, but rather infrastructure and institutional settings. Compelling evidence is still currently lacking, however, and needs to be compiled.¹⁵²

Based on their findings, they report that urban concentration may not by themselves be sufficient for productivity increases, unless supported by an appropriate institutional and cultural infrastructure sensitive to Auroville's cultural and research profile:

In the long run, the increasing level of urbanization is a natural consequence of economic development as many rural populations flow to non-agricultural sectors and urban areas. Reasonable urbanization generally also has a positive impact on economic growth ... In the medium to short term, urbanization speed has little effect on economic growth rate ... It is interesting and noteworthy that a higher speed of urbanization does not, as a rule, lead to more rapid economic growth ... Previously, it has been reported that there is no simple linear relationship between urbanization and economic growth. We argue that the result is robust. While urbanization *per se* may not lead to economic development, relative or other factors have played an important role in inducing economic growth and raising living standards. For example, urban concentration, agglomeration economies, and expansion of built-up areas related to urbanization may help to stimulate economic growth and development. Recent cross-country evidence also shows that the potential of urbanization to promote growth is likely to depend on removing barriers to rural-urban mobility, supportive policies, markets and infrastructure investments. To explain the between-country differences, on the other hand, more factors need to be considered, and these may be summarized as geography, history, cultural tradition, governmental management, and institutional setting, which vary between nations. Different countries have aggregated a diverse set of properties.¹⁵³

These complex links between growth and sustainability, density and productivity follow from characteristically urban agglomeration dynamics – an area in which Auroville's movements are

¹⁵² Chen et. al., 2014, 1-2.

¹⁵³ Chen et. al., 2014, 1-2 ('Discussions and Conclusion').

yet incipient, and where its experiments and experience holds potential for the future, to guide other collectives.¹⁵⁴ This is important because it resonates with Mother's vision for an appropriately-developed economy in an appropriately-managed urbanization process for a mid-sized aggregate, infused with the evolutionary drive of Auroville's spiritual mission. However, Auroville's current demographics, and institutional limitations, do not seem to allow for a sufficient division of labour, specialization-based innovation, productivity increases or capital surplus for growth. The benefits and challenges of scale, key to the urban environment, are not represented in Auroville. Insofar as Auroville's urban aspirations go, a thorough comparative study with the rich and insightful literature on the dynamics of urbanization – social, economic, political and environmental – is important to identify causes and consequences of demographic planning strategies appropriate to its spiritual aspiration.

3. *Distributional Questions and Spatial Justice*

Increased densities lead naturally to distributional conflicts in resource scarce environments. The scarcity of resources, as Rawls notes, is one of the preconditions of the problem of politics (understood in its refined sense, a constituent element of the collective yoga): this requires a society to identify just and stable arrangements for the distribution of material resources, including land, housing, water, food etc.¹⁵⁵ As the literature demonstrates, urban densities intensify that concern, the 'wicked problems of urban planning', with widening wealth and income inequality, socio-economic exclusion, gentrification and variable standards of living.¹⁵⁶ Critically, urban environments require special attention to be paid to problem of spatial justice that arise due to agglomeration dynamics:

[We] need to assert the status of the city as a concrete, localized, scalar articulation within the space economy ... identifiable by reason of ... its specialized land uses, its relatively dense networks of interaction (including its daily and weekly rhythms of life), and the ways in which it shapes not just economic processes (such as the formation of land, housing and labor prices) but also socialization dynamics, mentalities and cultures.

The discussion ... identifies a major aspect of the urbanization process as being rooted in the spatial concentration of production and ... cumulative dynamic of clustering and sorting ... This is because the supply of space at any given point in the city is always strongly inelastic so that preferences in regard to access and separation (or, alternatively, proximity and avoidance) can almost never be fully satisfied, a predicament that is magnified by differences in ability to pay and the locational rigidities that are intrinsic elements of the built forms of the urban land nexus.

Firms and households represent the foundational elements of two broad divisions of the urban land nexus, identifiable respectively as the production space of the city where work and employment are concentrated, and the social space of the city as manifest in residential neighborhoods, typically differentiated by variables such as income, race and class. In addition, a third space can be detected, namely, the

¹⁵⁴ There is a vigorous literature on the subject. *See*, for example, Peak Urban, 2023.

¹⁵⁵ Rawls, 1997, 110, 126, 226.

¹⁵⁶ *See*, for example, Soja, 2010; Soja, 2009; Manjeya et. al., 2023; Bibri et. al., 2020, for a review of opportunities and challenges of 'compact cities'.

circulation space of the city, which is represented by the infrastructures and arterial connections that facilitate intra-urban flows of people, goods and information.

...

The overarching conditions of political authority and power leave deep traces on urban development in any given society. These conditions typically define the scope of local government and urban planning activities, and hence influence the detailed spatial functioning of the urban land nexus, just as they almost always have strong implications for the dynamics of local political contestation.¹⁵⁷

At its current density, Auroville does not represent these problems and as such, cannot be a model town in that regard. As many have noted, Auroville's image as an elite bubble relates, and not without reason, to this factor.¹⁵⁸ An increased density – leading to 33 persons per hectare – will bring into play the important issue of spatial justice for deliberation and resolution.¹⁵⁹ This experiment will become all the richer given the plurality and heterogeneity of Auroville's demographic make-up. Indeed, it is interesting to query how the growth of consciousness and transcendence of material desire relates to Auroville's urban planning choices, in terms of the nature and amount of production of food, goods and services, the kinds of social infrastructure that one would find in the city, particularly on the Crown, and the social calculus of distribution of scarce resources, including housing, water, maintenances, employment, educational and other opportunities.

4. *Migration and Heterogeneity*

Fifth, urban centres are defined by migration, plurality and heterogeneity. As Scott and Storper note:

Agglomeration as process and outcome goes far beyond the narrow question of the technical foundations of economic geography, for it is a quasi-universal feature of human existence. Agglomeration touches many social, cultural and political/administrative dimensions of human life; and as a result, it has powerful feedback effects not only on economic development, but also on society as a whole.¹⁶⁰

This presents both challenges and opportunities.¹⁶¹ Cultural heterogeneity allows ethnic, cultural, linguistic, class and in Auroville's context, national barriers to be broken, generating tolerance and mutual understanding while aspiring to the spiritual ideal of human unity in diversity, the keynote of Sri Aurobindo's discussion in the *Ideal of Human Unity* and Mother's vision for Auroville. We discuss this utopian ideal of a rooted cosmopolitanism in Part III.A. On the flipside, anonymity and fragmentation of social interactions increase with size and density, secondary contacts are substituted for primary ones, traditional bases of social solidarity are strained, pressure is put on closely-knit and intimate neighbourhoods, increasing the chances of cultural conflict and driving competition. As we note in Parts III and IV, each of these are reflected in Auroville's rich social dynamics given its uniquely international composition. Today Auroville has residents of approximately 58 nationalities. However,

¹⁵⁷ Scott and Storper, 2015; 7-8, 10; *see generally*, Soja, 2010.

¹⁵⁸ *See*, for example, Kundoo's remarks in Majumdar, 230; Revi, 2007, 2.

¹⁵⁹ *See*, for example, Dikec, 2001.

¹⁶⁰ Scott and Storper, 2015, 6.

¹⁶¹ *See*, for example, Umemoto and Zambonelli, 2012; Morris, 2013; Wirth, 1938.

critical density and representation are yet to be reached. This was a nascent trend in 2001, and still so today – as the Masterplan noted:

The population growth till now has been rather slow. However, it may be observed that since a critical mass has already been formed and the development activities are picking up, Auroville will attract a large number of people from various countries in the years to come.¹⁶²

In this regard, Auroville presents exciting possibilities, realized in seed-form today, that can serve as a model if cultural unity in diversity is developed. But to manifest a living unity in the vital intensity of the Auroville *urbs*, contrasted with an eco-village setting, Auroville must take on and resolve this problem – unity in intimate quarters – at a critical density. In this regard, we note here that (in 2008, with guestimates today in the same range) 68% of the population was concentrated in three nationalities – Indian, French and German – and 80% in six nationalities – adding the Italian, Dutch and American residents, with 25 of 43 nationalities having 10 or less representatives.¹⁶³ For Auroville to be a living manifestation of the ideal, and particularly for the robust development of the yet-underdeveloped International Zone, a critical mass of diversity across nationalities and cultures is important in planning for future population increases.¹⁶⁴

5. *Rural and Urban Linkages*

A common concern across urbanization processes is the link between rural and urban centres. Urban transformations are helpful for rural development, poverty reduction, employment generation, capital extension and technology transfer, provision of tertiary education, healthcare and civic facilities etc. (an area in which Auroville has done substantial work through its outreach programmes, as we note in Part III.C), while rural development benefits the urban system through ecosystem services, provision of material resources and agriculture, natural beauty and connectedness and rich, local cultural traditions (an area in which Auroville's Green Belt has recorded remarkable work, as we note in Part III.G, with work to be done in agriculture and rural integration). At the same time, urban environments can impoverish neighbouring rural regions through extractive practices and uneven migration flows, a point Sri Aurobindo mentions in his short discussion on metropolitan settlements. There is a deep literature on the subject, which is beyond our scope. Tacoli's review of literature is helpful to place Mother's ideal of the Green Belt and integrated rural development in perspective:

Rural-urban linkages include flows of agricultural and other commodities from rural-based producers to urban markets, both for local consumers and for forwarding to

¹⁶² Perspective Masterplan, 2001, para. 1.6.4.

¹⁶³ Thomas and Thomas, 2013, 331-2.

¹⁶⁴ Revi, 2007, 3 had raised this concern earlier ('While there is wide international representation, there are few Arab, East Asian Aurovilians and no Chinese.') See also, Auroville Today, January, 2014, 294 ('Which bring me to the question of whether Auroville is truly 'international'. If we assume that you need at least ten members of a nationality for critical mass - and ten is setting the bar low as some of those may be babes in arms - we can only claim that 17 nationalities are genuinely represented in Auroville today. No less than 12 nations have only one representative at present, not enough to share a cup of tea and chat about the old days back in, say, Ecuador or Ireland. As to the nationalities we have lost this year, according to the figures we have been given there are no more Estonians, Greeks, or Taiwanese. Where have they gone? And why? The weather? The food? More casualties of the housing crisis?')

regional, national and international markets; and, in the opposite direction, flows of manufactured and imported goods from urban centres to rural settlements. They also include flows of people moving between rural and urban settlements, either commuting on a regular basis, for occasional visits to urban-based services and administrative centres, or migrating temporarily or permanently. Flows of information between rural and urban areas include information on market mechanisms – from price fluctuations to consumer preferences – and information on employment opportunities for potential migrants. Financial flows include, primarily, remittances from migrants to relatives and communities in sending areas, and transfers such as pensions to migrants returning to their rural homes, and also investments and credit from urban-based institutions. These spatial flows overlap with inter linkages between sectors both at the household level and at the level of local economies. They include back-ward and forward linkages between agriculture and manufacturing and services, such as production inputs and the processing of agricultural raw materials. Most urban centres, especially small and intermediate ones, rely on broad-based demand for basic goods and services from surrounding populations to develop their secondary and tertiary sectors. Overall, synergy between agricultural production and urban-based enterprises is often key to the development of more vibrant local economies and, on a wider level, to less unequal and more ‘pro-poor’ regional economic growth.

...

Increased access to information on different and often distant places has an important role in younger generations’ desire to migrate to experience the wider world, and to move out of farming in favour of more ‘modern’ types of employment in services and – albeit less so – manufacturing. Changing employment opportunities can have a profound impact on traditional social structure ... In South India, young men from landless low castes, who find employment in urban centres, openly defy the caste system as they are no longer dependent on their upper caste, land-owning employers for a living. Whilst these transformations clearly encourage individual independence, and should be welcomed for breaking up social relations based on power imbalances, their economic and social consequences are far reaching and still not sufficiently understood ...

Several papers ... point to a process of increasing social polarization, whereby wealthier households use both rural and urban resources as part of an accumulation strategy, whereas poor and vulnerable households and individuals negotiate the rural–urban continuum for survival.

Indeed, one of the main reasons for the failure of many policies that, since the 1960s, have attempted to draw on rural–urban linkages to promote regional development, is that they were based mainly on assumptions which did not necessarily reflect the real circumstances of specific locations and the people living and working there. By contrast [the literature] show the importance of tailoring interventions to the specific environmental, social, economic and institutional context of each urban centre and its surrounds ... [a] decentralized approach that is driven by local demands and priorities with the participation of a wide range of stakeholders in planning and implementing

initiatives. Put differently, policies that support the positive aspects of rural–urban linkages need to be based on strengthening local democracy and civil society ...¹⁶⁵

This characteristically urban concern resonates with Mother’s repeated emphasis on integrated rural development. As we note in Part III.E, these factors are variously at play in Auroville’s regional context, and will be placed in sharp relief as population numbers grow (as also by local speculation and socio-economic growth in the bioregion). The Green Belt offers an opportunity to engage rural-urban linkages in a Rurban setting to develop a sustainable model for other cities. In this vein, the Masterplan places Auroville as a site for experimentation at this intersection:

Till recently, urban growth was considered undesirable and all policies emphasized preventing migration from rural areas. However, these policies have not succeeded and urban areas are growing rapidly and becoming more and more degraded. Presently, both national and international opinions are in favour of urbanisation, as they have become engines of development, and emphasise policies that promote urbanisation. Taken too far, these policies may also become untenable, because of the heavy toll urban areas impose on limited natural resources and their unbridled growth is liable to disrupt the food security of the entire nation. This is why planners today are talking of establishing strong rural-urban linkages.¹⁶⁶

6. *Ecological and Aesthetic Concerns*

Finally, urbanization processes have strained ecological limits, in some cases to a breaking point. There is a dense literature on the topic, that considers impacts in terms of deforestation, habitat loss, biodiversity harms, climate effects, land erosion and decreases in soil quality, modification of hydrologic and biogeochemical cycles, with degradation of water resources, including overextraction of freshwater, pollution, congestion and associated medical effects, inflation of energy demands driven by unsustainable consumption and production habits and a range of other concerns.¹⁶⁷ As the Quito Declaration summarizes:

Sustainable urban development, as framed under Sustainable Development Goal 11, involves rethinking urban development patterns and introducing the means to make urban settlements more inclusive, productive and environmentally friendly.¹⁶⁸

This has led to a widespread recognition for sustainable development both nationally and globally, with massive investments to course-correct, and in some cases, a more radical realignment with our natural roots. Aesthetic concerns too have been prominent in criticisms of urbanization, with a loss of beauty and harmony to unchecked utility. This drive to sustainability and aesthetic sense, and indeed even more, a deep reconnect with our spiritual roots to nature and form, is intricately connected to Mother and Sri Aurobindo’s vision. It is widely reflected in Auroville’s community discourse today, and as the Perspective Masterplan notes, the ideal is ‘to make Auroville the most eco-friendly city.’¹⁶⁹ It is in reconciling, or synthesizing, the urban and ecological imperatives that Auroville’s challenge lies, and where its success will be measured, neither in an idyllic ruralism or eco-village setting nor an

¹⁶⁵ Tacoli, 2003, 4-5.

¹⁶⁶ Masterplan, 2001, para. 2.4.3.

¹⁶⁷ See, for example, Quito Declaration, 2016; Seto et al, 2011.

¹⁶⁸ Quito Declaration, 2016, para. 5.

¹⁶⁹ Masterplan, 2001, para. 1.1.2.

unreflective, congested urbanism.¹⁷⁰ The current density levels and sprawl dent Auroville's aspirations to sustainability, denting the benefits of the exemplary green works undertaken. As Kundoo pungently notes:

We need to understand that Auroville is more sustainable than sustainability. In sustainability the most important thing is an integral thinking. As a term sustainability is newer than Auroville but that doesn't mean that Auroville, as envisioned, is less sustainable. As a living experiment of integral yoga, no aspect is left out in its vision or its city plan. The most important thing that environmentalists and others must realize is that the sprawl and lack of density we now have is the most unsustainable model according to all international standards, specially in the Indian context, where many people often live on little land, and the agricultural space is diminishing. Today, Auroville can absolutely not be considered a sustainable model no matter how many buildings are made with earth blocks, or how much we treat our waste water. It is an elitist model. We need to support many more people on the land.¹⁷¹

Sustainability concerns have been a key concern, and often a fault-line, in Auroville's development debate, particularly in relation to the preparation of the Detailed Development Plan. Auroville has thus witnessed a resistant and slow phase shift from the first phase of environment regeneration to the second phase, post 2001 – at the level of the ideal, it is clear that Auroville was envisioned to be an ecologically vibrant city, a relatively dense yet rejuvenating, ecologically rich living environment. The practical challenge of Mother's vision is precisely to transcend the polarities. The Full Report of the 2015 Retreat, which we consider below, offers a helpful, practical integration:

	Belief / view / stand	Counter belief / view / stand	Example of Integration that may take us beyond polarities
7	Not a single tree must be cut in Auroville.	All trees that have been planted in areas that are earmarked for urban development need to be cut.	<i>Many trees were planted to arrest top soil erosion with the knowledge that at some point in the future these trees will have to be transplanted or cut. Respect the built-up / open and green ratio of the city (48% / 52%) and of the green belt (5% / 95%).</i>

(Source: Full Report, Auroville Retreat, 2015, Annexure 5, 65)

In sum, our short and summary discussion of the characteristic markers of the urbanization process maps on to Mother's vision for Auroville – it indicates quite clearly that her vision anticipated characteristically urban problems and planned for Auroville's development on the lines of urban reform. This account of spiritual urbanism, if we may call it that, suggests that the urban environment provides an evolutionary *spatial form* in which concentrated evolution occurs, leading to the emergence of a gnostic society: developing a spiritual 'city' or township, therefore, is part of the material *raison d'être* of Auroville and not simply a coincidental, or supplementary, occurrence. If Auroville is to lead the evolution, and hasten the advent of a

¹⁷⁰ Masterplan, para. 1.1.2.

¹⁷¹ Majumdar, 2017, 230.

spiritualized city, it must accept and solve urban density problems in their fulness.¹⁷² Adapting this to Sri Aurobindo's schema, we may suggest that each individual resident and the Auroville group-soul collectively is a 'consenting agent' – though the consent of the inner being is hidden from our view – to this creative task, not despite but *because* of the challenges it brings for a fuller realization.

iii. *What the Earth Needs: Auroville's Urban Future*

Casting a quick historical glance, Auroville founding came at the head of a nascent shift in urban thinking, years ahead of its time. It was co-terminus with the United Nations Conference on Human Settlements in Canada in 1976 (Habitat I), which recognized the problems of 'uncontrolled urbanization' and associated 'social, economic, ecological and environmental deterioration.'¹⁷³ This was reiterated in Turkey in 1996 (Habitat II) and the New Urban Agenda of the Quito Declaration on Sustainable Cities and Human Settlements in 2017 (Habitat III), adopted unanimously by the General Assembly in 2018, signalled a growing recognition of urbanization as 'one of the twenty-first century's most transformative trends'.¹⁷⁴ It notes in response:

We commit ourselves to working towards an urban paradigm shift for a New Urban Agenda that will

(a) Readdress the way we plan, finance, develop, govern and manage cities and human settlements, recognizing sustainable urban and territorial development as essential to the achievement of sustainable development and prosperity for all;

(b) Recognize the leading role of national Governments, as appropriate, in the definition and implementation of inclusive and effective urban policies and legislation for sustainable urban development, and the equally important contributions of subnational and local governments, as well as civil society and other relevant stakeholders, in a transparent and accountable manner;

(c) Adopt sustainable, people-centred, age- and gender-responsive and integrated approaches to urban and territorial development by implementing policies, strategies, capacity development and actions at all levels, based on fundamental drivers of change, including:

(i) Developing and implementing urban policies at the appropriate level, including in local-national and multi-stakeholder partnerships, building integrated systems of cities and human settlements and promoting cooperation among all levels of government to enable the achievement of sustainable integrated urban development;

(ii) Strengthening urban governance, with sound institutions and mechanisms that empower and include urban stakeholders, as well as appropriate checks and balances, providing predictability and coherence in urban development.¹⁷⁵

¹⁷² Sri Aurobindo's biting humour, speaking to the vitality of the Prophet Muhammad's spiritual enterprise, resonates here: 'Mahomed's mission was necessary, else we might have ended by thinking, in the exaggeration of our efforts at self-purification, that earth was meant only for the monk and the city created as a vestibule for the desert.' CWSA, 1997, Vol. 12, 443.

¹⁷³ Habitat I.

¹⁷⁴ Habitat II; Quito Declaration, 2016.

¹⁷⁵ New Urban Agenda, 2017, 8.

In the past few decades, these concerns have occupied national and global fora, with a host of ‘smart city’ and urban redesign programmes aggressively addressing problems identified above, backed by a vigorous academic literature on the ‘new urban science’.¹⁷⁶ We may reference, in India and Tamil Nadu as proximate examples, the 2015 Smart Cities Mission and the 2021 Report on Reforms in Urban Planning Capacity by the Niti Aayog, the New Jawaharlal Nehru National Urban Renewal Mission and the G-Square Integrated Smart City project in Tamil Nadu; Singapore’s 2021 announcement of an ‘eco-smart-city’, ‘smart city’ proposals in New York, Chicago, London, Barcelona, Singapore, Hong Kong, Dublin San Francisco and Seoul between 2013-15, and a host of other projects focussing on urban innovation and reform across sectors that speak to substantial developments globally. Very broadly, these include matters of central concern to Auroville: urban governance restructuring, environmental solutions, including climate mitigation and adaption, investment flows to sustain energy transitions with autonomous green energy production that do not unfairly externalize costs to rural areas, inter-disciplinary and decentralized approaches to urban planning, improved mobility frameworks with electrification of urban transportation systems, efficiency gains in land use arrangements, low-cost and high-density housing, with improved energy efficiency in building and construction strategies, addressing migration flows through rural and semi-urban capacity development, leveraging technology, incentivizing innovation and entrepreneurship through appropriate policies, developing circular waste economies, localizing food production with efficient supply chains etc.)¹⁷⁷ Despite these movements, the Quito Declaration Notes:

We are still far from adequately addressing these and other existing and emerging challenges ... there is a need to take advantage of the opportunities presented by urbanization as an engine of sustained and inclusive economic growth.¹⁷⁸

This background is relevant because it provides today’s context for Auroville – it tells us what ‘the Earth needs,’ a living laboratory, an experimental ground for other mid-sized aggregates to follow. As Mother noted, ‘people should want Auroville’. As such, Auroville is tasked with developing a new urban archetype, a unique form and solution to problems faced elsewhere, to lead the New Urban Agenda for a ‘well-managed urbanization’.¹⁷⁹ Arpi’s beautiful introduction to *Auroville: Smart City of Another Kind* which maps the ‘smart city’ idea to Auroville’s founding:

Like the famous Bourgeois Gentilhomme of Molière, who marvelled when he discovered that without even knowing it he had always been speaking in ‘prose’, it dawned upon me that being a smart city is what Auroville, in its own unique way, has been attempting to realize since 50 years. Whether in the field of environment, alternative energy, a ‘free progress’ education, a more collective economy, organic agriculture, industries respecting the environment, sustainable individual consumerism [and other areas] ... or, most importantly, an integral development of the individual, are we not endeavouring to be ‘different’, if not smart? ... Probably the Mother would not have liked the expression ‘smart city’; she would have preferred a ‘conscious city’ ... conscious of the future of the planet, conscious of the importance

¹⁷⁶ See, for example, Keith et. al., 2020.

¹⁷⁷ See, for example, Joss et. al.; Yin et. al.; United Nations Global Smart Cities, 2020; Almihat et. al., 2022.

¹⁷⁸ Quito Declaration, 2016, para. 4.

¹⁷⁹ New Urban Agenda, 2017, iv.

to be a model that could be replicated elsewhere: ‘There should be somewhere on earth ...’ It is still the dream which attempts to take shape. An integrally different city. A city which at least tries ... That could be a better definition of ‘smart’.¹⁸⁰

In addition to Arpi’s mapping of the smart city idea to Mother’s *Dream*, this also flows from Mother’s conception of Auroville as a microcosm of India, which itself is the ‘representation of all human difficulties on earth ... [and] it is in India that there will be the ... cure.’¹⁸¹ It for *that* – the resolution of difficulties faced elsewhere – that Auroville was created. For Auroville to meet these expectations, to be an urban model, it must address the six concerns identified above at critical size and density, sooner than later.

Needless to say, this ideal of spiritual urbanism presents a challenging task. But as Sri Aurobindo notes, an individual devoted to spiritual ends in the path of the Integral Yoga must take on *additional* problems – a collective like Auroville even more so:

Accepting life, he has to bear not only his own burden, but a great part of the world’s burden too along with it, as a continuation of his own sufficiently heavy load. Therefore his Yoga has much more of the nature of a battle than others; but this is not only an individual battle, it is a collective war waged over a considerable country.

...

The hope of an integral transformation forbids us to take a short cut or to make ourselves light for the race by throwing away our impedimenta ... Life then we must accept in our Yoga in order utterly to transmute it; we are forbidden to shrink from the difficulties that this acceptance may add to our struggle. Our compensation is that even if the path is more rugged, the effort more complex and bafflingly arduous, yet after a certain point we gain an immense advantage.¹⁸²

This sentiment is writ large in Sri Aurobindo’s thought. In the passage below, he outlines a call to arms to face the ‘revolvings of the great wheel’, to ‘stay firm in the storm and the race and the battle’ in the attempt to harmonize the ills of life with the transmuting touch of the spirit in the fulness of their opposition, not to reject them. Whether for the ‘lower’ reason of ‘weakness that shrinks from the struggle, the disgust and disappointment of the soul baffled by the great cosmic labour, the selfishness that cares not what becomes of those left behind us so long as we personally can be free from the monstrous ever-circling wheel ...’, or the ‘higher’ reason of wanting personal salvation ‘untroubled by the labour and the struggle’ of the world, a world which Auroville was formed to lead, he notes:

For the sadhaka of an integral Yoga none of these reasons are valid. With weakness and selfishness, however spiritual in their guise or trend, he can have no dealings; a divine strength and courage and a divine compassion and helpfulness are the very stuff of that which he would be, they are that very nature of the Divine which he would take upon himself as a robe of spiritual light and beauty. The revolvings of the great wheel bring to him no sense of terror or giddiness; he rises above it in his soul and knows from above their divine law and their divine purpose. The difficulty of harmonising the divine life with human living, of being in God and yet living in man

¹⁸⁰ Arpi, in Arpi (eds.), 2018, 14.

¹⁸¹ Guigan, 2018, Vol. 1, 71, 237, 259.

¹⁸² Sri Aurobindo, CWSA, 1997, Vols. 23-4, 77, 74. For a fuller discussion, see, Sri Aurobindo, CWSA, 1997, Vol. 31, Part IV.

is the *very difficulty* that he is set here to solve and not to shun. He has learned that the joy, the peace and the deliverance are an imperfect crown and no real possession if they do not form a state secure in itself, inalienable to the soul, not dependent on aloofness and inaction but firm in the storm and the race and the battle, unsullied whether by the joy of the world or by its suffering.¹⁸³

As a vehicle of collective evolution, synthesizing the elevated spiritual with the routine material, Auroville is to ground the ideal human settlement, an arena to which others can look for guidance and inspiration. Mr. Menon, the Minister of Human Resources Development, echoed this sentiment during the passage of the AVF Act, 1988, whilst securing Auroville's autonomy:

Auroville is to be looked upon as a vision which has a great potentiality, and this can be of tremendous service to India and the world at large.¹⁸⁴

Dr. Jagmohan, Minister of Urban Development and Poverty Alleviation highlights this vision in his foreword to the Masterplan: 'Its [Auroville's] development may provide a good model for emulation in other towns and cities as well.'¹⁸⁵ The text of the Perspective Masterplan too places this idea at the front:

The relevance of Auroville to the country as a whole is to use all the researches carried out here diligently and with commitment, individually and collectively, in order to raise the overall quality of life.¹⁸⁶

And back in 1920, after the publication of the *Arya*, Sri Aurobindo anticipated Auroville, then an unnamed Divine *sangha*, with the following letter to his brother:

What I am aiming at is not a society like the present rooted in division. What I have in view is a Sangha [community] founded in the spirit and in the image of its oneness. It is with this idea that the name Deva Sangha has been given – the commune of those who want the divine life is the Deva Sangha. Such a Sangha will have to be established in one place at first and then spread all over the country.¹⁸⁷

In Mother's vision, the key to the riddle is an elevation of consciousness – this spiritual aim married to practical problems of urbanization is where Auroville can be an exemplar. As Woiwode and Bhati note, insofar as contemporary models of urban planning and sustainability are 'largely of a socio-technical nature,' looking to resolve problems through technological or managerial machinery, the inward-turn and spiritual emphasis here offers a unique and much-needed platform for a deeper resolution.¹⁸⁸ French planner Gastebois similarly locates the smart city mission not only in technology driven improvements, where innovations have to be adopted or made through an appropriate scientific research infrastructure (an area yet to develop in Auroville), but beyond:

¹⁸³ Sri Aurobindo, CWSA, 1997, Vols. 23-24, 327 (emphasis ours); *see also*, the important discussion on this point in his *Essays on the Gita*. Sri Aurobindo, CWSA, 1997, Vol. 19, 54-5.

¹⁸⁴ Lok Sabha Debates, 1988, 477-8.

¹⁸⁵ Masterplan, 2001, 3.

¹⁸⁶ Masterplan, para. 1.2.10.

¹⁸⁷ Guigan, 2018, Vol. 1, 27.

¹⁸⁸ Woiwode and Bhati, 2018. They also float the interesting thesis – following Patrick Geddes – that urbanization itself is an evolutionary feature, creatively translating Sri Aurobindo and Mother's schema to an applied urbanism. Exploring this issue further is an exciting research area for Auroville.

Today, there is real pressure for India to find itself. If this smart city programme succeeds, it will be others who come to India looking for ideas. This is the challenge.¹⁸⁹

Auroville has marked a beginning in this direction. As Doctor-Pingel poignantly notes, the inspiring and exemplary early efforts of the pioneers that have led to the creation of a hospitable and enriching environment deserve recognition and gratitude:

Gratitude towards Auroville, that it exists even after 50 years, through all its struggles and limitations, and continues to be an ideal, a concept, a city in the making, nurturing the lives of those who converge here from all over the world. Gratitude also towards those pioneers who came to the barren red plateau and had the conviction to follow a dream, who gave their youth to make it what it is today: a green haven with opportunities for all.

...

These pioneering architects [and this may be extended to other professionals] have chosen different ways to express themselves ... their commitment and dedication to Auroville for a major part of their lives and careers is a common thread. Those works ... have created a sufficient body of works in Auroville ... [which] demands serious documentation, analysis of highlights and failures, and assessment of areas of replicability and relevance; not only for Auroville's own further development but also for India and the rest of the world.

...

Over many years of living and building in Auroville, I have come to appreciate the foundation that these pioneers have laid for us ... The spirit these pioneers had in those years, of not accepting 'no' for an answer and persevering against all odds to achieve a perfection that is a critical part of the 'Integral Yoga' of The Mother and Sri Aurobindo has made it possible for us to enjoy today the benefits of the seeds they sowed so many years ago.¹⁹⁰

Similarly, Thomas and Thomas' historical overview of the early years records the exemplary work done – often in a spirit of joyful innocence and enthusiasm – in face of back-breaking constraints.¹⁹¹ Building on these past efforts, *Auroville: Smart City of Another Kind*, for example, contains a series of interviews across sectors that give a sense of incipient movements in the direction of urban development today.¹⁹² This includes several noteworthy activities and enterprises in intelligent grid development, solar energy, mobility solutions, water management strategies, agriculture, education etc., with potential for scaling and future research. However, as we consider in our sector-wise overviews in Part III, the need for *collective* planning and policy action for major pushes in investment, infrastructure and population numbers is still lacking, without which individual enterprise is hindered in its growth. At its current size and scale, Auroville is yet to take up the urban challenge in its earnest, with persistent institutional concerns, delayed implementation of development plans and slow growth. For Auroville to become a smart city, however one defines the term, it must become a *city*. The phase shift from

¹⁸⁹ Arpi (ed.), 2018, 16.

¹⁹⁰ Doctor-Pingel, 2012, 3-4.

¹⁹¹ Thomas and Thomas, 2013.

¹⁹² Arpi (ed.), 2018.

the environmental concerns that predominated the first phase must now be met with an urbanist frame, with its attendant challenges and opportunities.

In several interviews, conversants noted that there is a reluctance to urbanize precisely *because* of the problems attendant to that process identified above: increasing densities and infrastructure development place resource and population pressures, invite greater construction and industrial activity. For example, Majumdar quotes Kundoo to reflect this sentiment:

... for many the future is to avoided just because it is inconvenient or uncomfortable to adapt to ... [This is due to] ignorance ... or a lack of interest. There has to be a curiosity, an openness to understand the city plan. People carry fears of the cities they left behind, or the kind of industrial urban development after the second World War. But so many urban environmental innovations and solutions are being tried now. There seems to be an unwillingness, a lack of courage to experiment.¹⁹³

It appears this fear has led, as Ayer. et. al. identify, to a governance concern, with negative incentive structures for Working Groups: ‘policy planning undertaken by nominated working group members, leading to a systemic bias against development for growth ...’¹⁹⁴ This fear with urbanization is understandable, but misplaced. The usual problems that accompany urbanization, particularly in industrial settlements, were well known to Mother. Her vision for Auroville, with the Galaxy Model as a base, was precisely to tackle these problems *head-on* and *early-on* (‘if you run away from difficulties, you will have to run away from life’), to innovate and create an urban settlement that is modern, economically and industrially dynamic while also aesthetically inviting and communally warm. Anger’s interview quoted above in the early stage of planning is a case in point. His close exchanges with Mother point unmistakably to a spiritual transformation of the urban landscape:

She explained her plan to me in detail. She explained that building the city would be an experiment – a spiritual research would be carried out: in the work of the town, in matter, through the friction of relationships with people – and the difficulties ... a collective adventure.¹⁹⁵

As Kundoo notes, while innovations in urban design are being attempted elsewhere, records indicate that there is an extended reluctance to enter that game in Auroville. In doing so, it risks being left behind, rather than leading the movement, as indeed is already the case in several key sectors. Naturally, this process will involve change, temporary discomfort and creative friction generated by city-building both materially (with increased construction, access ways, lesser space and material resources per resident etc.) and otherwise (with conflicting ideas and social pressures due to greater density and plurality) – yet, that is where the urban experiment lies. A rejection of city-life and infrastructure elsewhere may be necessary to begin with but it is insufficient until filled with something positive, just as sometimes a difficult, vacant (but not inert) intermediate state intervenes between the rejection of the old and the welcoming of the new in the yoga¹⁹⁶ – this is the spirit in the which the first masterplan of 1968 – which we gather was not formalized – remarks:

¹⁹³ Majumdar, 2017, 230-1.

¹⁹⁴ Ayer et. al., 2019, 28. This raises serious issues, as we discuss in Part IV.

¹⁹⁵ Majumdar, 2017, 235.

¹⁹⁶ Sri Aurobindo, CWSA, 1997, Vol. 31, 286-7.

This show how inadequate are the standard techniques and vocabulary of Town planning. But this inadequacy *should not exempt us* from carrying out a research on the leading principles of organization and working of the urban space.¹⁹⁷ ... principal function of the town is to promote [in contrast with planning techniques extant at the time] a new culture by creating a *novel urban civilization*.¹⁹⁸

In this vein, the establishment of the Centre for Urban Research, the Integral Sustainability Institute, Centre for Building Energy Research & Development,¹⁹⁹ the Centre for Scientific Research and the Auroville Earth Institute were notable early initiatives in this direction to anchor the research and experimentation process.²⁰⁰ Their work has since been internationally acclaimed, and they require robust support to develop and expand their work (though we were unable to locate the Centre for Urban Research's current projects or find out whether it is operational).²⁰¹

The recent approval by the Governing Board in its 60th meeting of an Auroville Smart City proposal, jointly with the Centre for Development of Advanced Computing, the Ministry of Electronics and Information Technology and faculty from IIT Tiruchirapalli, is also a significant and timely move towards the ideal:

This collaboration would lead to a new wave of infrastructure development in the city that would amalgamate the aspirations of the citizens with the benefits of technology to open up a new window of services & technological capabilities including supercomputing facilities, modelling and simulation, pollution monitoring, IoT, cyber security as well as language technologies.²⁰²

It is in this context that the Perspective Masterplan (or any subsequent master planning document), which we discuss in Part III, 'serves as an important instrument to guide the process of urban development' in line with Mother's vision.²⁰³ Twenty-two years since its adoption, however, most development proposals have witnessed a delayed implementation. We address these issues sector-wise in Part III, but as an exercise in ground-clearing, we address two overarching debates which entered several conversations during our research and have historically hampered decisive action.

¹⁹⁷ First Masterplan, 1968, 1.

¹⁹⁸ First Masterplan, 1968, 1 (emphasis ours)

¹⁹⁹ See, Auroville Foundation Annual Report, 2016-17, 30.

²⁰⁰ The work of the Auroville Earth Institute in particular, with active research, training, and consultancy, has been widely acclaimed. Notably, it hosts the representative for Asia of the UNESCO *Chair* on Earthen Architecture, Constructive Cultures and Sustainable Development. See, Thomas and Thomas, 2013, 161-165. The pioneering role of the Centre for Scientific Research in energy and environmental work, including for the construction of the Solar Kitchen, waste water recycling, building technology and solar installations is recorded in Thomas and Thomas, 2013, 88-9. The Centre also anchored Thomas and Thomas' comprehensive review of Auroville's economy. See, Auroville Foundation Annual Report, 2019-20, 41-2, for recent works on Kinisi and Humanscapes.

²⁰¹ 'Studies and Research', Auroville Centre for Urban Research. Auroville Architecture, 2004, 113.

²⁰² Minutes of 60th Meeting of the Governing Board, 2022, Item 60.10. We were not able to access this proposal, which limits our discussion. The proposal does not seem to include the TDC, and awareness of it in the community was limited. The challenge in smart city initiatives as this will be in marrying community participation with internal and external technical expertise, to allow for the swift, yet shared, development of the city as an expression of those resident with technology-leveraged and data-driven decision-making, a missing component today. We discuss this briefly in Part III.A.

²⁰³ Masterplan, 2001, paras. 1.1.1, 2.11.1.

D. ‘THE ELEPHANTS IN THE ROOM’: FALSE DICHOTOMIES

In discussions on city-building, we often encountered three debates: first, whether the purpose of Auroville is to build a city or to build a new man and second, whether Auroville’s growth must be organic or planned. We consider a related third ‘elephant’ – whether population growth to the number of 50,000 residents should be slow or fast – in Part IV.E. As the 2015 Retreat Report notes, these are persistent debates that

... regularly undermine progress, promote stagnation and result in frustration. These blockages, which may be polarities, are often deeply rooted in personal frames of reference and are rarely openly discussed (‘elephants in the room’). A list of opposing viewpoints was read on the second day together with possible syntheses that could transcend these polarities ...²⁰⁴

We agree that these polarities ought to be reconciled, in the spirit of Mother’s following remark:

Each one has good reasons to support his own opinion, and I am no expert to judge between them. But from the spiritual point of view I know that with true goodwill all opinions can be harmonised in a more comprehensive and truer solution.

Not that some give way to others, but that on the contrary all should combine their efforts to achieve a more comprehensive and perfect result.²⁰⁵

In this section, we briefly explain this position: Auroville’s task is to build a new man *and* a new city, in a way that is organic and measured *as well as* planned and urgent.

i. The First Elephant: A New City or a New Man

On the first debate, the question is whether the purpose of Auroville is to build a new city or a new man.²⁰⁶ The Full Report of the 2015 Auroville Retreat, a robust exercise for community-wide reflection and realignment conducted at the behest of the Governing Board and International Advisory Council, notes:

	Belief / view / stand	Counter belief / view / stand	Example of Integration that may take us beyond polarities
1	We are here not to build a city but a society.	We are here to build a city, not a society.	<i>We are here to build a city and a society, a society manifested in the form of a city.</i>

(Source: Full Report, Auroville Retreat, 2015, Annexure 5, 64)

The question, in other words, is whether the spiritual task of the descent of higher grades of consciousness precedes or predominates the material task of city-building. This debate is not simply a matter of mechanics – rather, it concerns the *raison d’etre* of Auroville’s founding and has significant impact, as we note in Part III.A on implementation of the Masterplan. Particularly, if consciousness-raising precedes city-building, concrete decisions on the development of urban infrastructure and planning must await a general raising of consciousness

²⁰⁴ Full Report, Auroville Retreat, 2015, 63.

²⁰⁵ Guigan, 2018, Vol. 2, 294.

²⁰⁶ See, for example, Danino, 2021, 1-2, quoting Anger’s comment that what ‘matters is not to build a city, but to build new men.’

(notwithstanding the insuperable difficulty in identifying a measure for this occurrence). The Retreat Report notes:

14	We should first reach the level of consciousness that the Mother wanted in Auroville and only then can we build the town and attract more people.	We have to first build the town and the town will attract more people who will collectively develop the consciousness that seeks to manifest in Auroville.	<i>The building of the town and the growth of consciousness will go together. The physical growth of the town will attract people and activities. People and activities will attract physical development. The town with its people is the "laboratory of evolution."</i>
----	---	--	---

(Source: Full Report, Auroville Retreat, 2015, Annexure 5, 66)

As the Report outlines, this is a false dichotomy: the task of spiritual evolution, Auroville’s central concern, is accomplished through the *instrument* of city-building. The dichotomy between the material (city-building) and spiritual (consciousness-raising) imperatives is one that is belied by the synthetic philosophy and method of practice of the Integral Yoga. Sri Aurobindo’s life-affirming approach addresses this debate:

The thing to be done is as large as human life, and therefore the individuals who lead the way will take all human life for their province. These pioneers will consider nothing as alien to them, nothing as outside their scope. For every part of human life has to be taken up by the spiritual, – not only the intellectual, the aesthetic, the ethical, but the dynamic, the vital, the physical; therefore for none of these things or the activities that spring from them will they have contempt or aversion, however they may insist on a change of the spirit and a transmutation of the form. In each power of our nature they will seek for its own proper means of conversion; knowing that the Divine is concealed in all, they will hold that all can be made the spirit’s means of self-finding and all can be converted into its instruments of divine living ...

There are many who perceive the necessity of the religious and moral regeneration, who are inclined to turn from the prosaic details of politics and commerce and regret that any guide and teacher of the nation should stoop to mingle in them. That is a grievous error.²⁰⁷

In the context of Auroville, Mother pointedly notes:

The opposition between spirituality and material life, the division between the two, has no sense for me as, in truth, life and the spirit are one and it is in and by the physical work that the highest Spirit must be manifested ... The important thing is to make the experiment.²⁰⁸

The idea is not to increase population for the sake of it, or to build the city first and then call people to inhabit it – as Anger notes:

If people who come to make this profession of faith are unable to *build their own environment*, it would mean that their city is a failure. It’s essential that is being built at the level of the individual experience ... In our urban conceptions, we make a city on paper, the conception is as intelligent as it can be, and *then* we ask people to live

²⁰⁷ Sri Aurobindo, CWSA, 1997, Vol. 8, 249.

²⁰⁸ Guigan, 2018, Vol. 1, 281, 298.

in it. Here the process is inverted, people live an experience and it is *from this experience* that their environment is created.²⁰⁹

The development of Auroville must be in lock step with the development of consciousness of its residents – the two progress *together*: ‘Auroville is not merely a city but also a way of life.’²¹⁰ As the Full Report of the Retreat notes:

14	We should first reach the level of consciousness that the Mother wanted in Auroville and only then can we build the town and attract more people.	We have to first build the town and the town will attract more people who will collectively develop the consciousness that seeks to manifest in Auroville.	<i>The building of the town and the growth of consciousness will go together. The physical growth of the town will attract people and activities. People and activities will attract physical development. The town with its people is the “laboratory of evolution.”</i>
----	---	--	---

(Source: Full Report, Auroville Retreat, 2015, Annexure 5, 66)

Building a robust material infrastructure, with a margin of excess capacity (say, 10-20%, particularly in housing, schooling / tertiary research, entrepreneurial incubation) to accommodate new residents, and an inviting culture of spiritual living, will attract those aligned with the vision. This will further spur development and so on. This is a mutually reinforcing process, a snowball effect, which will build scale incrementally. The Perspective Masterplan outlines this strategy for growth:

Today Auroville has such a work force of over 1,000 persons, who have assiduously built up its base and infrastructure, which may now attract more such dedicated people. A systematic further development of infrastructure will attract a working population to Auroville from all over the world ...²¹¹

Just as it is unwise to build the city before inviting people to live in it, so is waiting for people to come before taking steps to build. One may otherwise wait a long time for Godot. The energy and enthusiasm of new residents will bring in fresh possibilities and problems, add more reactants to the spiritual experiment, as it were, and avoid the issues of minority capture, repeat players and entrenched deadlocks that are longstanding concerns in Auroville’s governance landscape as we discuss in Part IV. It will push the city forward. The idea that we must wait for the higher consciousness to descend before we grow is, to adapt Unger’s influential idea, a false necessity: for us to change, move forward and imagine newer ways of being at the micro-level, we need not wait for a macro-level event. This illusion – common to our thinking in Unger’s explanation – paralyses the will to act, ‘to see how the something else could arise out of the here and now.’²¹² In this vein, asked the astute question in an interview, will ‘Auroville and New Men create each other?’, Anger pointedly replied: ‘Without a doubt, it is obvious’.²¹³

²⁰⁹ Anger, YouTube, n.d. (emphasis ours; we have relied on the translations provided in the video).

²¹⁰ Guigan, 2018, Vol. 2, 177.

²¹¹ Masterplan, para. 2.1.1.

²¹² Unger, 2001, xx.

²¹³ Anger, YouTube, n.d.

The allied concern that increasing population numbers and fast-paced development may dilute the general state of consciousness and add difficult, or perhaps unwanted, elements is reasonable. Three points may be made here.

First, as we discuss in Part IV.E, the task of increasing population numbers, particularly the entry and acculturation process, must be handled carefully to ensure that newcomers are aligned with the vision. Appropriate strategies can be devised, through careful public messaging, positive outreach and robust research partnerships with select institutions, without engaging crude or wanton publicity. Greater awareness of the activities of Auroville and an invitation to participate in that process are preferable to a silent wait.

Second, while it is important to ensure that newcomers are aligned with the vision, it is unreasonable to place placing unduly high entry barriers. Those currently resident in Auroville arrived with imperfect, aspiring states of consciousness. To apply a different standard to others aligned or interested in the vision (or potentially interested, provided the right kind of outreach and public information reaches them) is inappropriate – ‘... as a general rule, never ask from others the virtues you do not possess yourself.’²¹⁴ As Mother repeatedly noted, it is ultimately the pressure of the public spiritual environment prevailing in Auroville that will determine entries and exits through a process of self-selection. Sitting in judgment over others’ capacities is a task reserved for the illumined within the community and even then, ought to undertaken with great caution and a wide margin of appreciation. Sri Aurobindo considers the question of fitness in detail in *Letters on Yoga* – whilst a certain core alignment is needed (a ‘call’), with basic capacities and qualities, he counsels that it

... is useless to raise the question of fitness. No one is fit — for all human beings are full of faults and incapacities — even the greatest sadhaks are not free.²¹⁵

On these lines, Mother asked only sincerity and goodwill, with a mix of plasticity and discipline, from candidates.²¹⁶ Illumination is not a pre-condition to work in Auroville, but the result of it:

If men had to stop work when they are not perfect, everybody would stop working. It is in the work that we must progress and purify ourselves.²¹⁷

Third, a collective yoga demands variety, fullness and density in the population to be representative of other collectives – part of Mother’s founding ideal – to act as a spiritual research and development centre, as it were, ‘in the midst of all of this chaos.’ The perceived dilution is compensated by the integrality of the work:

... if we take the example of what is happening here, where the individual remains right in the midst of all this chaos... That’s the difficulty! Doesn’t this very fact make a certain perfection in realisation impossible to attain? But the other case, the individual isolated in the forest, is always the same thing – an example giving no proof that the rest will be able to follow; while what’s happening here should already

²¹⁴ Mother, CWM, 2002, Vol. 13, 155.

²¹⁵ Sri Aurobindo, CWSA, 199, Vol. 29, 33.

²¹⁶ See, Mother’s remark: It goes without saying that for admission to live in this ideal place the essential conditions that need to be fulfilled are good character, good conduct, honest, regular and efficient work and a general goodwill. Guigan, 2018, Vol. 1, 49; this is in relation to an early precursor to Auroville, which was not realized.

²¹⁷ Guigan, 2018, Vol. 2, 299.

have a much broader radiating influence. At some point this has to happen – it must happen. But the problem still remains: can it happen simultaneously with or even before the supramentalisation of the single individual? (silence) The realisation under community or group conditions would clearly be far more complete, integral, total and probably more perfect than any individual realisation.²¹⁸

It is worth noting here that a similar question – whether to realize first and then expand, or to progress with a wider base – was considered by Mother and Sri Aurobindo in the context of the expansion of the Sri Aurobindo Ashram in the 1940s to accommodate refugees fleeing from the war. They noted that the increase in numbers would lead to a dilution of the general level of consciousness, but that the consequent realization would be wider. If this reasoning applied to the Ashram, a relatively more concentrated field of work, in their presence, then *a fortiori*, it can apply to Auroville today.

It is trite to say that Auroville’s approach to city-building is unique, and ought not to necessarily follow in the footsteps of other urban collectives. The development of physical infrastructure divorced of its spiritual goal is contrary to the vision. Yet, as a ground for *karma* yoga, it is precisely the task of city-building, in its tangible and intangible elements, that places pressure on the individual and collective to manifest that consciousness. Work, as Sri Aurobindo noted, is a ‘*means* of self-dedication through Karma,’ and not, at least in the early progression of our evolution, its result:

There is a period, more or less prolonged, of internal effort and struggle in which the individual will has to reject the darkness and distortions of the lower nature and to put itself resolutely or vehemently on the side of the divine Light. But there is still a sort of gulf or distance which necessitates an obscure process of transit, not always accurate, sometimes even very distorting, between the divine Origin and the emerging human current. At the end of the process, with the progressive disappearance of egoism and impurity and ignorance, this last separation is removed; all in the individual becomes the divine working.²¹⁹

In this progressive scheme of development, the work of city-building acts as an instrument for purification and aspiration. Woiwode and Bhati translate this point in the context of urban planning:

Spatial and urban planning in particular is concerned with understanding, organizing and structuring our built environment in relation to and the context of social, cultural, political, geographical and historical issues, among many other spheres. Problem solution and conflict resolution capacity is thus central to planning practice and theory. This said, any set of problems or crises leads or should lead toward a rethinking of our planning concepts, approaches and instruments.²²⁰

In sum, the enterprise of city-planning presents the ground for attending to the problems of collective organization that are at the heart of Mother’s founding vision:

²¹⁸ Guigan, 2018, Vol. 1, 75.

²¹⁹ Sri Aurobindo, CWSA, 199, Vols. 23-4, 60-1. Mother similarly notes, ‘When I give work to someone it is not only for the sake of the but also as the best *means* to advance on the path of Yoga.’ CWM, Vol. 13, 159 (emphasis ours).

²²⁰ Woiwode and Bhati, 2018, 46.

It may even be said that the supraphysical can only be really mastered in its fullness — to its heights we can always reach — when we keep our feet firmly on the physical. ‘Earth is His footing,’ says the Upanishad whenever it images the Self that manifests in the universe. And it is certainly the fact that the wider we extend and the surer we make our knowledge of the physical world, the wider and surer becomes our foundation for the higher knowledge, even for the highest, even for the Brahmaildyia.²²¹

In this context, many registered a fear of path-dependency generated by definitive action today – in other words, the idea that urgent and decisive actions to grow today may lead to unalterable mistakes *now* due to our relative state of ignorance that could be avoided if those decisions were made from an illumined state of consciousness *later*. As an interviewer asked Anger:

There is a formation which says, ‘Fortunately the city was not build in twenty years because huge and colossal mistakes would have been made.’²²²

This is an understandable fear, but it is in the nature of experimentation and progress that errors will be made. Sincere errors are preferable to delayed action: ‘... it is by great & noble failures that humanity advances.’²²³ Swiftmess in action does not necessarily mean error, just as slowness does not guarantee truth. The corrective, as we consider in Part IV, is to incorporate strong, independent processes for decision-making and information-rich, high-frequency evaluation and feedback loops in execution to correct mistakes quickly and iteratively, assisted by the wisdom of the collective (with a voluntary preference for the views of the wise) and Mother’s words, if not yet her direct guidance through the inner being.²²⁴ In short, a strong and decisive pace of growth with quick learning loops to hasten the progress. Development plans are not cast-in-stone and will evolve, yet that evolution must take place through real-time execution of a large net of micro-projects (a strategy that builds system resilience against the spillover risk of failure or mistakes) with a unified intention to manifest the vision. As Mother notes:

If they can agree, the work will go faster! So there. Objections of detail don’t matter because you start with one idea and end with another – you progress a lot in between. So it doesn’t need discussion, it’s only ... Only, try to put your energies together so as to start sooner, that’s all!²²⁵

To sum up, to the extent that this dichotomy has acted as a block to the material development of the city and resulted in inaction, with missed opportunities for growth, this elephant in the room is both unhelpful and unnecessary.

²²¹ Sri Aurobindo, CWSA, 199, Vols. 21-22, 13-4.

²²² Majumdar, 2017, 237.

²²³ Sri Aurobindo, CWSA, 1997, Vol. 12, 455. In general, we note that Mother’s view – demonstrated across the board in her *Agenda*, and even before, in her handling of the organization of the Sri Aurobindo Ashram, was to accept problems and difficulties, not to recede. Nirodbaran’s description, as an early and trusted disciple, of Mother’s attitude is a useful insider’s account with insights for these debates – a fear of urbanization, taking definitive action, increasing numbers etc. – in Auroville. He makes the interesting observation, for example, while he himself was a little worried about the risks of several new ventures undertaken by Mother, he ‘knew that the Mother’s very nature is to face danger.’ Nirodbaran, 1973, 117-8.

²²⁴ The Full Report of the 2015 Auroville Retreat suggests changes along this line, with a conative-doxative loop to allow for quick institutional reform. See, Full Report, Auroville Retreat, 2015, 70. This was not put into practice. We discuss this in Parts III and IV.

²²⁵ Guigan, 2018, Vol. 2, 58.

ii. *The Second Elephant: Planned or Organic Development*

A similar analysis flows for the related debate on ‘planned versus organic development.’ As we discuss in Parts III and IV, a raft of planning proposals for the ordered development of the city since 2001 have remained on paper, with on-ground developments proceeding unsystematically outside of a policy framework. In part, this is because traditional planning instruments, such as the Masterplan and its proposed hierarchy of plans, are viewed with disfavour, in preference for ‘organic’, i.e. non-planned, growth. Development is naturally neither entirely fixed nor completely fluid, yet what seems to have resulted in the demand for organicity is inefficiency and disorganization. It is thus important to clarify the place of planning and organicity in Auroville’s development.

This debate between the two planning approaches is not new. Lohman’s account of the first meeting of the Auroville Planning Group in October, 1971 notes:

In the discussion which followed an interesting problem regarding Auroville and the group arose, in which Roger is very much aware of. The problem centres around the integration of the existing Tamil population and whether we are not too concerned with imposing – both on them and on ourselves – a prefabricated plan into which everybody has to fit, and if it is not better to let the city and each one’s participation in it grow spontaneously. Roger explained the two methods open to us: the first with which he would like to agree, is, no designs, no plans, no committees. Just let it happen, give it a chance and all the time it needs, and we’ll see what comes out of it. For, after all, it is a spiritual and evolutionary experiment in which unknown forces play a role and it will happen anyhow, with us or without us. The second possibility is, to decide how Auroville is to be built, in which case we can do nothing but project a model and keep on evaluating and correcting it. We have to remain supple, yet work from a preconceived base. He said he did not see a third solution, but he invited the group to come up with one, for he would be happy with it. And yet, I have the feeling that a third solution is precisely what we are looking for, because Auroville is meant to find that third way.²²⁶

The third way, it appears to us, is the desire for a spontaneous, or inspired, emergence of harmonious actions responsive to changing circumstance without a dimming through distorted mental translations – ‘God’s spontaneities tied with formal strings / And packed into drawers of reason’s trim bureau.’²²⁷ This was Mother’s mode of operation, the ideal of the spiritual anarchist in Sri Aurobindo’s view applied to urban planning. As such, Auroville *is* meant to find that third way:

Where Will is one with Truth and Good with Power;
Impoverished not by earth-mind’s indigence,
They keep God’s natural breath of mightiness,
His bare spontaneous swift intensities.

...

Compelled to a spontaneous servitude,
The ever-changing incalculable steps,

²²⁶ Guigan, 2018, Vol. 2, 279.

²²⁷ Sri Aurobindo, CWSA, 1997, Vols. 33-4, 285.

The seeming-reckless dance's subtle plan
Of immense world-forces in their perfect play.²²⁸

The route to that ideal and elevated state of spontaneity in city planning is concomitant with the arduous step-wise ascension from the vital-mentality of the ego to the psychic being, spiritual and finally, supramental realizations. As is the state, so is the method: given that these spiritual states are yet unattained in the collective, the labour of a long and persistent work of disciplined planning and execution with the best mental lights at our disposal, offered to the Divine in the spirit of *karma* yoga for progressive purification, is in our view an appropriate process for development activity in the city. Disciplined work, mindful of time-bound actions and attentive monitoring, leads to the Divine anarchy (and conversely, any 'relaxation of this discipline produces [collective] illness', in this context, development blockages and conflict).²²⁹ Relating this to our discussion, rejecting the mental scaffolding of planning instruments, absent a sufficient inner purification, risks a free play to false vital subjectivism under the disguise of organicity. In this context, three practical points can be made:

First, some constitutional features of Auroville, defined in Mother's vision discussed above, and associated programmes approved by her, are naturally to be carried out as planned as quickly as matters allow. These include the national pavilions, technical colleges, university frame, the Lines of Force etc.

Second, the Masterplan provides a broad policy framework that concretizes some aspects of the Galaxy Model, and retains space for future decisions, innovations and creativity with time – it is 'neither rigid nor static' and yet allows for 'systematic development and expansion of activities and population' for a progressive manifestation of the city.²³⁰ We discuss specific proposals, as also the consultative process that led to its drafting, in Part III.A, but briefly: the Masterplan lays down broad policies and directions for growth in the primary zones, determines the hierarchy of roads and access ways, identifies land use zones, determines standards for common facilities of education, health and social needs, identifies basic physical infrastructure requirements, presents a roadmap for land acquisition and outlines investment requirements for these activities.²³¹ In doing so, it envisages a seven-stage waterfall of development plans – from the Masterplan to the Plan of Projects – to manifest the general concept of the Galaxy Model and Mother's vision into progressively concrete and particular plans for development.

Third, plans need not be either rigid or entirely without form. While the diametrically opposed frames of 'free and organic growth' and 'rigid planning' may be useful as a matter of defining the intellectual extremes, a common tact for framing debates, it is unhelpful to deploy it as a rhetorical argument-ender, as we often witnessed in archival material and conversations. We remember here Sri Aurobindo's remark:

The capital period in my intellectual development was when I could see clearly that what the intellect said might be at once correct and not correct; that what the intellect

²²⁸ Sri Aurobindo, CWSA, 1997, Vols. 33-34, 281, 324.

²²⁹ Guigan, 2018, Vol. 1, 327.

²³⁰ Masterplan, 2001, para. 2.11.1.

²³¹ Masterplan, 2001, para. 2.3.1.

justified was true and its opposite was also true ... As you go higher up, a wider movement develops which reconciles all contraries.²³²

In that vein, an important archival document to reflect on this debate is the letter signed by the Mother to the Ford Foundation on 13th March 1969 requesting funds for Auroville ('the Ford Foundation letter').²³³ This is one of the few documents of the Mother that contain a detailed articulation of the planning approach to Auroville, and as such, we take it to a guiding blueprint that ought to inform planning debates and serve as a benchmark for evaluation today. We were informed in discussions that the letter was drafted by Suresh Hindocha, a Pondicherry based industrialist whom Mother had put in charge of the Industrial Zone, and signed by the her. While we could not locate any textual evidence in the archives to support this fact, both the narrative style of the letter and the reference to 'the Mother' in the third person on page 13 support this reading. That does not however diminish the importance of the letter, given Mother's express approval of its contents.

In general, several conversants brought up the issue of the appropriate interpretive principles to be adopted whilst reading Mother's guidance, to remain sensitive to context and avoid dogmatism. The Full Report of the 2015 Retreat notes the opposing viewpoints, with a helpful reconciliation:

15	"Mother said..." so we should follow this.	'Mother clarified that the truth is evolutionary'	<i>Clarify when Mother is speaking of fundamental principles and when she is indicating an area where knowledge will develop according to the developing consciousness of the Aurovillians</i>
----	--	---	--

(Source: Full Report, Auroville Retreat, 2015, Annexure 5, 67)

We thus propose and adopt the following interpretive principles for understanding Mother's words in this study:

- i. Mother's words must be read in the context in which they were spoken, to the particular conversant in relation to the issue at hand. A distinction must be drawn between decisions relevant for the time in which they were made, and permanent guidance which is relevant today.
- ii. In case of an apparent inconsistency or change of opinion in Mother's words, a harmonious interpretation that gives effect to the underlying purpose manifest in those documents, ought to guide the interpretation.

²³² Purani, 2017, 79.

²³³ The Ford Foundation replied to this letter indicating that it would not be able to fund Auroville as it was already involved in other projects in India. As a matter of historical interest, there is debate on why the funding did not materialize, indicating early divisions that surfaced after Mother's passing. See, Letter, 'SAS Refusing Ford Foundation Offer to Fund and Weary of Hindocha Family Taking Control of Auroville', n.d. In general, disagreements in the Committee on Administrative Affairs constituted by the Mother and led by Anger persisted at the time. See, for example, Guigan, 2018, Vol. 2, 182.

- iii. Caution must be had in divining the purpose, or ‘hidden intent,’ behind Mother’s words where it is not manifest.
- iv. Mother’s words are to be read in light of Sri Aurobindo’s thought, particularly in resolving interpretive issues.
- v. Documents signed or initialled by Mother are authoritative, even if initially authored by a disciple.
- vi. Views expressed by Mother’s chosen instruments for the work of Auroville bear weight, yet are not final.

Given the relevance of the Ford Foundation letter, and our understanding that it has not been widely read, we provide here a summary commentary on it to reflect on the issue of planning approaches. The letter begins by outlining ‘the systems engineering approach to the planning of Auroville,’ with a particular emphasis on town planning. With Auroville still in its nascence, and several streams of work yet undefined, Mother’s approach (i) is systematic, planned and highly specified, (ii) is comprehensive across sectors, (iii) places a strong emphasis on timely execution, regular evaluation and monitoring and (iv) presents a blend of idealism and pragmatism.

The letter identifies four reasons for the systems planning approach, each relevant today. The first is to ‘achieve maximum results from the least expenditure of resources and time’, and avoid an inefficient method of implementation that results in waste of resources ‘necessitating further expenditure to rectify mistakes’. The second, to support a ‘multidisciplinary approach’ to town planning. The third is to monitor and evaluate the spending of funds donated by third parties, which it terms a ‘major responsibility’. The fourth is the need for a clear execution strategy. Here, the letter notes:

... so far progress at Auroville has been, quite frankly, of a slow and unsystematic nature when compared to the possibilities that exist with the use of the systems engineering approach, which is a highly goal-oriented planning and implementation approach – a process which is efficient and directed. Hence the development of Auroville has reached a stage where the systems engineering approach for the work at hand is a necessity.²³⁴

Two points are striking in this passage. The first is the self-reflective note that progress has been slow and unsystematic (absent any exaggerations or spiritual rhetoric) particularly in a letter to an external funding agency, and the second is the clear orientation towards an efficient, goal-oriented and as the letter later notes, time sensitive approach to the planning of Auroville. A ‘directional approach,’ if we may call it that, is the central concern. The letter defines the ‘systems engineering approach’ as

being concerned with planning, developing and implementing a town in a manner that achieves the goals for which the town is established with the least expenditure of resources ... [This] approach is a relatively new technique employed in the solution of complex problems.²³⁵

²³⁴ Ford Foundation Letter, 1969, 2.

²³⁵ Ford Foundation Letter, 1969, 2.

This approach is then detailed out in the following words:

The systems engineering approach ... involves ... a phased development plan, which covers the project from the beginning until its construction is completed. This preliminary phased development plan was the outcome of our meetings ... with Dr. S. I. Firstman of the Planning Research Corporation, Los Angeles ...²³⁶

These phases were identified with precision, going from ‘town concept, functional analysis, conceptual design, preliminary design, detail design, construction [to] implementation.’ The first three phases – to be completed on a war footing in fifteen months – are then detailed out with the following key points:

First, the town concept phase is to establish the ‘economic, social and physical goals for the town and determine for them a time sequence.’ For this,

- i. ‘performance goals’ are to be set up – identifying both ‘budgetary constraints’ and ‘time limits.
- ii. ‘a fund acquisition plan’ is to be drawn up identifying public and private sources of funding.
- iii. ‘a town feasibility analysis’ is to be conducted that would identify the ‘types of industry, commerce, agriculture and other economic activities’ – on this basis, a ‘preliminary economic plan’ is to be prepared.
- iv. strict monitoring protocols are to be established. The letter anticipates that establishment of ‘effectiveness measures’, ‘so that the goals of the town can be compared against these measures in a quantitative manner at a later stage of development.’
- v. an ‘organization that would do the town design, development and planning ... with positions, communications, documentation’ is to be created.
- vi. a ‘anticipated population profile’ is to be prepared, with a ‘plan to draw the preferred population’.
- vii. detailed ‘blue-printed time chart[s] covering the time limits for each phase’ are already developed, and annexed to the letter, specifying in great detail the personnel requirement and the precise ‘man-years’ required for each area of activity – for the first eleven months, Sri Aurobindo Society is slated to provide 27 man-years, with 8.5 man-years being solicited from experts; for the next four months, the Society is to provide 11.3 man-years, with 4.8 man-years from experts.

Second, in the town analysis phase, the ‘objectives’ for ‘transportation, education, communication, housing, industry, agriculture’, including the relationship between ‘transportation and industry, housing and pollution’, are to be defined.

Third, in the conceptual design phase, all within fifteen months still, the above areas of activity are to be ‘split into sub-systems, that is each function would have its own set of subsystems.’ For this,

²³⁶ Ford Foundation Letter, 1969, 3.

- i. 'trade off studies' are to be conducted to 'determine the most suitable subsystem from a host of alternatives'.
- ii. 'objectives and constraints' of each sub-system are to be identified.
- iii. 'relationship between different subsystems have also to be determined' – for example, 'in case of transportation relationships between the subsystems freight transport, and factory site and housing are important'.
- iv. 'inducements to attract specific economic activities (factories, stores etc.) have to be determined'.
- v. the 'transport network' is to be detailed.
- vi. a 'regional integration plan with its design and planning requirements' is to be detailed.

In what follows, the letter sets out in bullet points detailed points of action, each with a specified outcome. Some notable entries require the specification of a 'detailed town plan', 'pedestrian safety requirements', 'overall project cost', 'preliminary and then detailed financial plan with plan for minimum cash flow', 'development time requirements', 'effectiveness analysis', 'procurements and construction specifications', 'coordinated investment in public facilities (hospitals, schools etc)', 'plan for training social and service activity personnel', 'integrated staffing and training plan', 'measure performance of all town sub-systems', 'orderly sequence of implementation activities' and lastly, several years ahead of its time, the preparation of 'software for integrated data systems' and a 'data system collection and processing plan.'

In terms of the execution, while Mother is to 'guide the work of the whole organization', the 'overall responsibility for the execution of the project lies with the Project Director, who has a Project Management Team.' Indicating the need for a centralized coordination, a corrective required in Auroville today as we discuss in Part IV, the letter stresses the 'importance of the Project Director's role especially in providing leadership and making the project work.'²³⁷ As the work proceeds, the letter anticipates that the institutional structure will adapt itself. Equally, at the end of each phase, it outlines a review process – reflecting on the 'planning data' harvested from the work done – is outlined such that learnings can be quickly incorporated to keep the organism plastic. In this, the letter confirms the attempted reconciliation at the 2015 Retreat, which is again helpful to quote:

21	Auroville should keep experimenting with new structures / approaches.	We should rely upon old ways until we have the consciousness to use new ones	<i>Encourage widespread experimentation on alternative methods of governance in small groups. When something seems scalable, try it for a probation period in a larger work group with a fallback option to resume 'normal service' if it doesn't work out.</i>
----	---	--	---

(Source: Full Report, Auroville Retreat, 2015, Annexure 5, 67)

²³⁷ As we discuss in Part III, leadership and central direction are necessary even in aspiring for the ideal of anarchist spontaneity.

Thus, the Ford Foundation letter envisages a planning approach that is (i) cutting-edge and innovative; (ii) disciplined and time-bound, (iii) fine-tuned and execution-oriented and that incorporates, without hesitation, the best learnings from elsewhere whilst pushing to novel experiments. It provides clear benchmarks, both in terms of process and outcomes, by which to evaluate Auroville's progress and current state, as we discuss in Part III.

What emerges from this important document insofar as the debate on this 'elephant in the room' is concerned is a recognition of the false dichotomy between organic growth and planning-based approaches. The letter is clear that Auroville's development must be directional and planned, with (i) systematic phasing, precision as to goals, timelines and personnel requirements, (ii) including plans for internal capacity building and identification of external expertise, (iii) with an *ex-ante* organizational structuring with clearly defined sub-systems, and importantly, (iv) a responsive and quick feedback loop through rich and detailed data collection and well-leveraged technology to adapt to changing needs, thus maintaining flexibility. As we note in Parts III and IV, each of these are chronic governance concerns that require reform in Auroville today.

Without planning or form, an organism, if we take Auroville to be one, risks death by dissipation, and without the space for flexibility or organic growth, it risks death by inelasticity. Organisms grow according to well-developed, and iteratively evolving, plans: adaptive mutations aspiring to the light. As DP Chattopadhyay, former member of the Governing Board and a distinguished philosopher and commentator on Sri Aurobindo, notes: 'the internal dialectics of organicism without reductionism allows fuzziness, discontinuity and discreteness within limits.'²³⁸ It is in this vigilant play, responding to excesses in either direction with an appropriate corrective, that Auroville's aspiration for a spontaneous ordering may arise.

Indeed, Mother notes at various points the limitations of the intellect, mental calculations and operations in planning, and prefers spontaneity. Yet, she also makes this clear in the following pungent exchange, when presented with a desire to avoid planned organization, that this is not to be done prematurely:

Shyam Sunder: Many in Auroville say that an organised working is not desirable in Auroville; they are for spontaneous working.

[Mother replies:] Spontaneous work can be done only by a man of genius. Is there anyone claiming to be a genius?²³⁹

As we discussed above, Sri Aurobindo counsels that a premature anarchism risks disorder. In the context of planning, impulsive activity absent a cohesive overall plan risks giving a free play to a vital subjectivism in the name of something higher. The desire for spontaneity is to be progressively realized, or prefigured, *through* a disciplined, directional approach identifying precise outcomes with a clear plan to get there (one must, to roughly translate *Savitri* here, travel the world-stair). As Mother says:

²³⁸ Chattopadhyaya, xix, in Joshi (ed.), 2011. For a broad-ranging discussion on this subject, see, Rangaswamy (ed.), 2011.

²³⁹ Guigan, 2018, Vol. 2, 281.

A clear and precise vision of what is to be done and a steady, calm and firm will to have it done are the essential conditions for an organisation to be run properly.²⁴⁰

As Sri Aurobindo details in his *Synthesis of Yoga*, once a sufficient purification at the collective level is attained on the path, through the complex affair of aspiration and rejection, prayer and effort, contemplation and work, such that all is surrendered to Her, *then* organization can and will naturally become spontaneous by the force of previous effort:

I am very fond of proper organisation—if those who organise want sincerely to do it—I require only clear and precise information. When this is given and there is sufficient trust in the Organising Power it is sufficient. The rest will be done.²⁴¹

A premature demand for spontaneity, with an accompanying rejection of planned development, likely results in *tamas* or inertia (as reflected in the records, discussed in Part III.A). Sri Aurobindo sounds a clear caution on this front:

But still, in the practical development, each of the three stages has its necessity and utility and must be given its time or its place. It will not do, it cannot be safe or effective to begin with the last and highest alone. It would not be the right course, either, to leap prematurely from one to another. For even if from the beginning we recognise in mind and heart the Supreme, there are elements of the nature which long prevent the recognition from becoming realisation ... And even if realisation has begun, it may be dangerous to imagine or to assume too soon that we are altogether in the hands of the Supreme or are acting as his instrument. That assumption may introduce a calamitous falsity; it may produce a helpless inertia or, magnifying the movements of the ego with the Divine Name, it may disastrously distort and ruin the whole course of the Yoga. There is a period, more or less prolonged, of internal effort and struggle in which the individual will has to reject the darkness and distortions of the lower nature and to put itself resolutely or vehemently on the side of the divine Light. The mental energies, the heart's emotions, the vital desires, the very physical being have to be compelled into the right attitude or trained to admit and answer to the right influences. It is only then, only when this has been truly done, that the surrender of the lower to the higher can be effected, because the sacrifice has become acceptable.²⁴²

A rejection of 'ordinary' planning practices in preference for spontaneous activities, can be dangerous, if spontaneity is conflated with disordered or patchwork activity ('there is a lot of goodwill, but it is ... it does not seem to be organised'),²⁴³ or an easy rejection of learnings from the past or from developments elsewhere. Sri Aurobindo advises against pulling the carpet from under our feet:

In emerging, therefore, out of the materialistic period of human Knowledge we must be careful that we do not rashly condemn what we are leaving or throw away even one tittle of its gains, before we can summon perceptions and powers that are well grasped and secure, to occupy their place.²⁴⁴

²⁴⁰ Mother, CWM, 2002, Vol. 13, 155.

²⁴¹ Mother, CWM, 2002, Vol. 13, 155.

²⁴² Sri Aurobindo, CWSA, 1997, Vols. 23-4, 60.

²⁴³ Guigan, 2018, Vol. 2, 132.

²⁴⁴ Sri Aurobindo, CWSA, 1997, Vols. 23-24, 14.

As the Ford Foundation letter demonstrates, an activity as complex as city-building requires a planned and directional approach to avoid the pitfalls of dissipation, waste and disorganization, a timely caution given Auroville's historical record as we discuss in Part III.A – in Sri Aurobindo's words, without 'shape and form, life has no effective movement.' An effective and defined planning strategy, of the kind outlined in the Masterplan and the Urban and Regional Development Plans Formulation and Implementation Guidelines, is thus necessary. This intellectual polarity between organicity and planning must be integrated through a culture of process-based thinking at the level of practical day-to-day decisions, in the synthetic tenor of Sri Aurobindo and Mother's approach in the letter. The devil lies in the details of execution. This is naturally easier said than done, but the response to this challenge is what planning approaches in Auroville can contribute to the global debate.

We may also address here a related matter. In several conversations and in the records, we encountered the idea that the Divine will develop Auroville, as Mother noted, and as such, 'we should not get ahead with our mental plans.'²⁴⁵ This seems to be reflected also in the Masterplan prepared by the Residents' Assembly in 1999, which notes:

When the Mother was asked in early 1965 who will participate in the financing of Auroville, She replied 'The Supreme Lord'. In essence, this reply expresses two important realities about Auroville's development. One is that the physical manifestation of Auroville is in the hands of a higher Force and is consequently, bound to happen sooner or later. Second, that any planning and projection on financing Auroville's development has its limitations.²⁴⁶

This sentiment is true from the exalted perspective of theological determinism – from which Mother was speaking – articulated in Sri Aurobindo's *Life Divine*: ultimately, all, including error, is determined and sanctioned by the Divine. In Auroville, as a concentrated centre, perhaps particularly so. Yet, without further qualification, this is a partial statement that may incentivize laxity, or even worse:

The development of the experience in its rapidity, its amplitude, the intensity and power of its results, depends primarily, in the beginning of the path and long after, on the aspiration and personal effort of the sadhaka ... But still, in the practical development, each of the three stages [personal effort leading finally to a state of surrender where the Divine does all] has its necessity and utility and must be given its time or its place. It will not do, it cannot be safe or effective to begin with the last and highest alone. It would not be the right course, either, to leap prematurely from one to another.

... [It] may introduce a calamitous falsity; it may produce a helpless inertia or, magnifying the movements of the ego with the Divine Name, it may disastrously distort and ruin the whole course of the Yoga.²⁴⁷

²⁴⁵ See, for example, Mother's response to 'fundamental questions about Auroville, particularly answers two and three. Elsewhere, Mother notes: 'It [the city] will be built by what is invisible to you. The men who have to act as instruments will do so despite themselves. They are only puppets in the hands of larger Forces. Nothing depends on human beings – neither the planning nor the execution – nothing! That is why one can laugh.' Guigan, 2018, Vol. 1, 408-9.

²⁴⁶ Residents' Assembly Draft Masterplan, 1999.

²⁴⁷ Sri Aurobindo, CWSA, 1997, Vols. 23-24, 60.

As Mother and Sri Aurobindo counselled, faith generated by reliance on the Divine Will is not a substitute for individual effort and aspiration. The distinction between a *sattvic* surrender that aspires with an energetic intensity to manifest the Divine Will, and a *tamasic* surrender that awaits it, is central. Sri Aurobindo emphatically notes:

Reject too the false and indolent expectation that the divine Power will do even the surrender for you. The Supreme demands your surrender to her, but does not impose it: you are free at every moment, till the irrevocable transformation comes, to deny and to reject the Divine or to recall your self-giving, if you are willing to suffer the spiritual consequence.

...

An inert passivity is constantly confused with the real surrender, but out of an inert passivity nothing true and powerful can come. It is the inert passivity of physical Nature that leaves it at the mercy of every obscure or undivine influence. A glad and strong and helpful submission is demanded to the working of the Divine Force, the obedience of the illumined disciple of the Truth, of the inner Warrior who fights against obscurity and falsehood, of the faithful servant of the Divine.²⁴⁸

Sri Aurobindo further reminds us that intense and persistent individual effort is key to the descent of Mother's ever-present grace, to 'render impotent ... by our own choice' all movements contrary to the truth:

... the supreme Grace will act only in the conditions of the Light and the Truth; it will not act in conditions laid upon it by the Falsehood and the Ignorance. For if it were to yield to the demands of the Falsehood, it would defeat its own purpose.

The development of the experience in its rapidity, its amplitude, the intensity and power of its results, depends primarily, in the beginning of the path and long after, on the aspiration and personal effort of the sadhaka.²⁴⁹

But the entire substitution of the divine for the human personal action is not at once entirely possible. All interference from below that would falsify the truth of the superior action must first be inhibited or rendered impotent and it must be done by our own free choice. A continual and always repeated refusal of the impulses and falsehoods of the lower nature is asked from us and an insistent support to the Truth as it grows in our parts.²⁵⁰

To sum up, we note that Auroville's true plan – as also Mother and Sri Aurobindo's vision and words – can only be understood by the soul, in a spontaneous recognition of the truth. Yet, on the long path to that realization, a disciplined planning approach highlighted in the Perspective Masterplan, Ford Foundation letter and elsewhere provide a helpful roadmap – '. So long as the contact with the Divine is not in some considerable degree established, so long as there is not some measure of sustained identity, *sāyujya*, the element of personal effort must normally predominate.'²⁵¹ It is in this way that approaches to development planning ('mentally

²⁴⁸ Sri Aurobindo, CWSA, 1997, Vol. 32, 3-4.

²⁴⁹ Sri Aurobindo, CWSA, 1997, Vols. 23-24, 58. Similarly, as Mother repeatedly said: 'My help is with you always as complete as it can be; *it is up to you* to open yourself and receive it.' Mother, 1977, 13 (emphasis ours).

²⁵⁰ Sri Aurobindo, CWSA, Vol. 23, 86-7.

²⁵¹ Sri Aurobindo, CWSA, Vol. 23, 58-9.

conceived,’ and so limited in their assessment) can be dynamized, and yet retain a secure foundation to avoid disorderly development which the records indicate, a caution sounded repeatedly in Mother’s words:

That’s what is needed: to coordinate the efforts and create a unity with the parts ...
The atmosphere is dislocated; it has lost the cohesive power it had.²⁵²

In this light, the reticence to planned development requires reconsideration. The integration attempted on these issues in the 2015 Retreat, yet not resolved given continuing debates, stands on good ground. The Retreat Report notes that ‘old antagonisms and polarities are softening and a third space is emerging that everybody can support. Individual healing at a micro level was happening around the room.’²⁵³ Unfortunately, this momentum generated over the two days seems to have dissipated as we were met with these polarities often in our conversations. This indicates the need for more permanent fora for micro-level interactions on these issues in the community to build a lasting consensus. That said, these conversations must translate into action. As we note in Part IV, a constant and valid complaint of several has been interminable and repeated conversations on these issues, without follow-up action. For example, the ‘post-retreat’ processes outlined in the Full Report, for the relevant working groups act on the agreed outcomes within a period of three years, did not take place.²⁵⁴

This sentiment is not new – for example, Anger expresses this dissatisfaction bluntly:

Everything in Auroville can be contested now ... the attitude towards education, the responsibility towards children, the problems with money, human relationships, philanthropic falsehood. All these have become false arguments which lead to us a dead end ... She told us ‘Come and build a city’ ... if there was the slightest goodwill, what a scale the experience of Auroville could take! What shared knowledge! What perception of things! What knowledge of the other – and of oneself!!! It is fabulous experiment ... One has to come together [to] remove these veils so that the light becomes and more transparent.²⁵⁵

This requires a clear and strong executive mandate to move matters forward, and engage in these debates practically with concrete plans (funding, personnel responsible, defined outcomes with monitoring) and time-bound projects at hand – a settled public culture of decisive action to move the city forward. For this, as we consider in Part III.A, Auroville needs to make appropriate and urgent planning choices, given delays in implementing the Masterplan, preparing of the Detailed Development Plan etc., to galvanize cohesive growth.

Thus, to sum up, we note that Auroville needs to be an exemplar of the new urban agenda – for this, as we consider in Parts III and IV, a shift in organizational structures, processes and mindsets is required to reenergise the next stage of progress.

*

²⁵² Guigan, 2018, Vol. 2, 331.

²⁵³ Auroville Retreat, Full Report, 2015, 14.

²⁵⁴ Auroville Retreat, Full Report, 2015, Annexure 6, 68-70.

²⁵⁵ Majumdar, 2017, 238.

E. SECTOR-WISE MAPPING OF AUROVILLE'S GROWTH: TANGIBLES AND INTANGIBLES

Mother and Sri Aurobindo's ideal for Auroville places upon its residents a great and difficult responsibility. To be a true Aurovilian, as Mother defines it, is an ideal to progressively aspire for, rather than a status achieved. As She notes, '[it] is in writing: what an Aurovilian must be. Not easy.' This work is both within and without, though the defining inner movement is not necessarily visible to the eye. This presents us with a problem of evaluation for this study, and as several conversants noted, for internal assessment within the community: by what metrics can this progress be judged? It is naturally difficult to measure inner growth on quantifiable measures, and indeed, judgments on spiritual progress ought to be made with great caution. Nor is it helpful, as we have noted, to measure Auroville's progress in purely material terms. That said, certain markers are helpful in an assessment of progress:

Material progress in relation to Mother's ideals and specific programmes outlined.

Material progress in relation to programmes and policies adopted by the residents, particularly the Perspective Masterplan 2025 and other Working Group plans since, in relation to measurement of time and goal-oriented actions.

Demonstrable metrics of unity and harmony, or lack thereof, in the collective vision, planning and execution of such projects.

Standards of transparency, efficiency and accountability in the functioning of Working Groups, measured as against their own mandates.

Relevance to collective problems elsewhere in the world.

Compliance with legal norms.

In Part III, we provide a synoptic sector-wise summary along these markers, to identify challenges and development priorities. In Part IV, we study this empirical picture in light of Mother and Sri Aurobindo's guidance on collective organization outlined in Part I, to identify qualitative, 'subjective' challenges and suggest governance reforms.

*

PART III
SECTORAL OVERVIEW

All life is yoga.

Sri Aurobindo, *Synthesis of Yoga*

It is necessary, too, that she should correct her errors sometimes by a return to the restraint of sensible fact, the concrete realities of the physical world. The touch of Earth is always reinvigorating to the son of Earth, even when he seeks a supraphysical Knowledge ... 'Earth is His footing,' says the Upanishad ...

Sri Aurobindo, *Life Divine*

In this part, we review developments in Auroville together with Mother's vision and community planning documents across seven sectors to identify governance challenges and development priorities. Our attempt here is to offer a representative and thematic, rather than comprehensive, overview to identify salient points in the growth trajectory that may inform future planning choices. **Section A** examines city-planning and urban infrastructure development, particularly since the 2001 Masterplan (Perspective: 2025). **Section B** reviews land acquisition for the city. **Section C** considers regional and outreach planning frameworks. **Section D** examines the housing sector. **Section E** reviews the education and tertiary research landscape. **Section F** analyses the economic and commercial sector. **Section G** addresses agriculture and food security. We draw on the empirical picture outlined in this part to suggest governance reforms in Part IV.

A. URBAN PLANNING AND INFRASTRUCTURE DEVELOPMENT

As a ‘city’ in the slow making, Auroville’s ‘urban’ ideal englobes, in a sense, all movements. A complete review of urban planning and infrastructure development would encompass the entire catalogue of developments in Auroville since 1968, in both their tangible and intangible elements, materially and spiritually: if ‘all life is yoga’, the urban space of the ‘city of the future’ becomes a ground to manifest that ideal spatially in all sectors. The issue then is not simply to review the development of material infrastructure, though that is a key component, but rather, of the outer expression of an inner evolution across all streams of life. As such, Auroville becomes a testing ground for experiments in how dense, plural and productive collectives can thrive. In this, one may hazard to say that Mother anticipated, in seed-form, the ‘new urban science’: in its deepest aspiration, it is not only a series of problem-solving tweaks to improve urban settlements, but a paradigmatic shift in how one conceives the urban space. Manifesting this form, yet invisible, requires an understanding of the past and a bold aspiration for the future, a robust mix of technical excellence and spiritual aspiration, a play of imagination and realism, to allow for the progressive descent of the New Creation. As knowledge systems from across disciplines and geographies mingle in this emerging and pressing global conversation, Auroville stands uniquely placed to contribute its experience, if it indeed is to be ‘the city the earth needs’. Seen from this lens, an ‘overview’ of Auroville’s urban planning and infrastructure development becomes a layered, complex and fascinating avenue for inquiry.

Our aim however is far more modest: we outline the more tangible and quantifiable movements in city-planning – with a focus on developments post the Perspective Masterplan in 2001 – to better understand the governance challenges that present themselves. How the collective organizes its energies to allow for individual ingenuity and enterprise to manifest is the key concern. As the community nears the twenty-five-year mark for the review of the Perspective Masterplan, it is useful to reflect on the patterns of the past to design an effective move to the future. It is with this aim that Sections (i) – (ix) review the catalogue of planning strategies, studies and proposals, and their implementation that have followed. Section (i) briefly looks to movements in the early years from 1968-1999, (ii) reviews the process between 1999-2001 that led to the Masterplan and provides an annotated summary of the final document to benchmark development since, (iii) considers planning work on population numbers and targets, (iv) briefly reviews the implementation of planning strategies in the Masterplan, (v), (vi) and (vii) discuss efforts between 2001-2010, 2010-2015 and 2015-2019 respectively, each with a distinct push, and (ix) considers the issue of development of the Crown and mobility networks that were the focus of 2022. To conclude, Section (x) reviews this landscape to draw out governance and development priorities.

i. Movement in the Early Years, 1968-1999

The years between 1961 and 1968 saw consecutive plans drawn up by Roger Anger to materialize the vision of an ideal urban centre embodying human unity. After Mother’s approval of the concept, the Galaxy plan underwent further development by Anger in 1969, envisioning four zones representing key aspects of life, the Lines of Force (accommodating

housing and offices) and a ‘service ring’ (the Crown) to nurture community life at the intersections of the zones, all organized around the Matrimandir.¹

As the ambitious project to regenerate these infertile lands began, indeed one seed at a time, the early community developed relationships with the neighboring villages of Kuyilapalayam, Kottakari and Edayanchavadi, a meeting of two vastly different worlds, both culturally and materially, one aspiring to ‘the city of the future’, the other consumed by survival concerns.² Between 1970 and the late 1990s, developments came in the form of the first settlements at Aspiration and Auromodèle – ‘advance colonies’ to mark Auroville’s permanent presence and experiment with ways of living that may serve as a model for the ‘city’ to come.³ Ryckaert records the first movements:

The first plot of land was bought on 8th October 1964, almost three and a half years before Auroville’s inauguration. Between 1964 and 1973 about 2,000 acres (816 hectares), spread over an area of 24 sq. km and interspersed between privately owned land and government land, were bought. The land looked desolate in those early days and its inhabitants poor and uneducated. A district officer visiting the area at that time official declared it an ‘advanced stage of desertification’ and increasingly ‘unfit for human habitation’ if nothing would be done to reverse the ongoing severe erosion.

...

The first phase from the inauguration of Auroville in 1968 till the late 1970s saw mainly the construction of experimental huts and simple shelters by the early pioneers. Aspiration, Auroville’s largest settlement at that time and still existing today, showcased the possibility of simple homes made of mud walls, wood panels and thatched roofs. However, already then several residences built with steel and cement dotted the Auroville landscape.

Early records speak of the pioneering work to construct houses with palm leaf, thatch, *keet* and other vernacular building materials (later the famous ‘capsules’), small-scale workshops and production units in tailoring, crochet, handloom and handicrafts, subsistence farming, community kitchens, a publishing press and much more, as the early residents began to settle the land and accustom themselves to the rhythms of this new life. Slowly, gravel roads were shaped and a city imagined.⁴ A narrative history of the time, to piece together the hundreds of written accounts, oral histories, planning documents and photographs, is waiting to be written – a fascinating exercise to understand the motivations, hopes and aspirations with which this motley crew responded to Mother’s call, from seasoned businessmen and architects to young idealists, from hippies to scholars, many looking to escape the world but some with a fire to build the new. The story is perhaps best told through photographs, painstakingly curated by the Auroville Archives – we extract four that give a glimpse.

¹ See, Part II.A-B.

² See, for example, Majumdar, 2017; Savitra, 1980; History of Auroville, n.d.; Thomas and Thomas, 2013.

³ See, Mother’s early message for Auromodèle and Aspiration. Guigan, 2018, Vol. 2, 122, 194.

⁴ See, the Auroville Archives’ photo exhibition. History of Auroville, n.d.

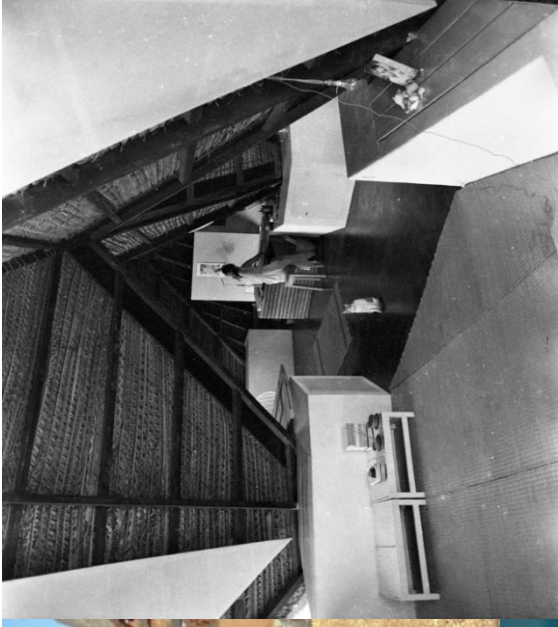

(*Top left*, Aspiration community *Top right*, inside a hut in Aspiration. *Bottom left*, gravel road near Aspiration. *Bottom right*, huts at Fraternity. *Source*: Auroville Archives, 2023)

Whilst the Galaxy concept served as the ideal – with Anger in regular correspondence with Mother till 1972 – in practice, Auroville’s development followed a trajectory defined by practical considerations of land acquisition, acculturation to the local climate and people, land and ecological regeneration, slow population growth, and capital and human resource availability. Land acquisition in the early decades was slow, with only 200 acres purchased between 1974 and 1992, which impeded ‘any serious progress towards designing and building the city.’⁵ Financial constraints too were severe – on November 11, 1970, Anger wrote to Mother:

The lack of financial means makes it indeed impossible to build enough individual accommodations, and to provide Auroville with both a concrete economic infrastructure and an effective organisation.⁶

Early economic experiments to develop a gift or sharing economy – Pour Tous, Circles, Nandini and Envelopes, which we discuss in Part III.F – ran into resource constraints, with ‘no real prospect of providing adequate living conditions – let alone developing with some harmony an ever larger ‘township’.⁷ Developments were, as with the demanding circumstances of the time, scattered and piece-meal, unfolding wherever land, capital and human resource infrastructure was available – as we narrate sectorally in Sections B-G, early records speak to a motley catalogue of works, spread across the sparse terrain, with vibrant educational initiatives, spurts in construction of housing, assisted by a period of economic growth in the early 80s, the construction of Bharat Nivas and the beginnings of village outreach. By 1977, there were already twenty communities with an average size of twenty residents, each operating more or less independently in a loosely organized collective setup.⁸ Thomas and Thomas paint a picture of the newly christened collective at the time:

... new residents on that barren land received what was necessary to meet their minimum needs, including some cash, from the Beach Office in Pondicherry, operated by the Sri Aurobindo Society (SAS). Collective housing began in a settlement called ‘Aspiration’, while other communities were being established more informally in the centre and at ‘Forecomers’. Auro Food and Auroshikha were two industrial activities among several established during the early years. Auro Food, for instance, was established by the SAS well outside the envisioned city and green belt area in order to generate sustained income for the growth of the township; Auroshikha was first established in Auroville and later relocated to Pondicherry. From the earliest days extensive records are available as a result of the involvement of the Sri Aurobindo Society, as well as the minutes that were kept and are still available in the Auroville Archives. Records are also available of the weekly community meetings, in which collective decision-making was practiced. One obtains an impression of ad-hoc community formation in a rather large area, leading to a widely dispersed grouping of very small settlements.

...

⁵ Thomas and Thomas, 2013, 88.

⁶ Guigan, 2018, Vol, 2, 182.

⁷ Thomas and Thomas, 2013, 289.

⁸ Thomas and Thomas, 2013, 69.

At the same time, people began to move onto other areas of land, providing their own simple structures in which to live. Interestingly, in that early pioneering phase already some large homes of a permanent nature were built in what was called ‘Auroson’s Home’ but is now named ‘Certitude’, as well as the ‘Auromodèle’ settlement ... In this period, inter- national associations, commercial units, project funding for the villages, small-scale agriculture, reforestation, and collective projects (such as the Matrimandir) started in a modest small-scale manner. It is the phase of designing ‘projects’, purchasing land (on the part of the SAS), establishing farms and settlements, and creating wells, kitchens, schools, production workshops and roads. The inspiration and leadership of the Mother through her presence in nearby Pondicherry enabled the Auroville project to get off the ground, at times under harsh conditions ...⁹

Majumdar gives an insider’s account, worth remembering today, of the freshness and hope, variety and eccentricity, an air of something different, in an environment that seemed to be its very opposite – a living metaphor for the synthesis of the elevated spiritual with the hard material:

Already, there was a mix of nationalities and genders, but a fascinating variety of personality types from different social, educational and economic backgrounds, of different age groups and a wide variety of interests – just enough to get an experiment going ... So off they went in a jeep ... across the red, bumpy roads, to a vast barren place with a few huts and the Last School building overlooking the sea. Nothing else ... It was also an innocent time. We lived and died for Auroville.

...

The land was open, a wide soul space. Everything seemed possible. It was an age of the Kata Vandis (bullock carts with wooden wheels). Tyre Vandis were deluxe. It was an exciting time, the future seemed close ... A lone capsule in the middle of nowhere besides a windmill was also emblematic of the times. People settling in parts of the Greenbelt were more pragmatic. They planted trees, made bunds to control soil and water erosion, started orchards, and a dairy farm. But apart from the collective cluster in Aspiration, settlements were few, small and far in between.¹⁰

During this period, the community’s energies were predominantly channelized towards the ambitious task of land regeneration, now internationally acclaimed and part as it were of Auroville’s *itihasa*, and the all-important task of building the Matrimandir. Records from the time – particularly =1, *Auroville News, Contributions*, early planning documents housed in the Auroville Archives and a range of autobiographical works – document the extraordinary resilience and ambition of the pioneering work in the first decade.¹¹ The spartan living conditions at the time, chronicled in various photo exhibitions, serve as reminders of the remarkable transformation of the landscape and the audacity of the first Aurovilians whose work laid the foundations for the city to come.

⁹ Thomas and Thomas, 2013, 62-3.

¹⁰ Majumdar, 2017, 68-9.

¹¹ See, for example, *Contributions*, 1980; Savitra, 1980; Lohman, 1972.



(Photographs of Auroville lands, undated, late 60s, early 70s. *Source: left, AVI USA, right, Auroville Archives, 2023*)

Major disruptions came however in the conflict with the Sri Aurobindo Society, which we discuss in Part V.¹² This derailed several development plans, and led, among other things, to the exit of close to 20% of the population, including Anger – Mother’s chief instrument for city-building from 1975 to 1987. Ciconesi and Ciconesi recount the movements in the early years:

However, the land designated for the city and the surrounding green belt needed to be purchased. The vast funding required, both for land and construction of the City, did not materialize immediately. As the first Aurovilians began to trickle in and settle down on the land, they learned about the rhythms and culture of the people around them in the villages, who were impoverished and mostly uneducated. Millions of saplings were planted simply as a measure of self-survival from the dust storms and the heat of the barren vast plateau. Slowly, the Galaxy plan – with its huge multistoreyed buildings, monorails and moving sidewalks – appeared more like a distant dream that would take its own time and course in manifesting. Other problems and awakenings at the global level led to further awareness; the oil crisis of the early seventies and the accelerating environmental movement brought new insights into such idealistic city-planning. Thus, inevitably Auroville began to grow slowly, organically, in a piecemeal manner. Small-scale, labour-intensive construction along with cultivation, reforestation and various specialized cottage industries seemed more appropriate and sustainable. The Mother passed away in November 1973, and that became another milestone for Auroville.

Roger Anger, faced with the responsibility of manifesting the City as envisaged, became increasingly frustrated with the situation. To avoid getting drawn into the power struggle that was then enveloping the township and its residents, he resigned from the main organizing committee in 1975 and ultimately left for France in 1976, returning eventually in 1987 to play an active role again. In the interim, many difficulties arose, sometimes questioning the very existence of Auroville. Nevertheless it has managed to survive in its spirit and grow on a material level.¹³

We review these varied developments – in land acquisition, regional and outreach planning, housing development education and research, commerce and economy, and forestry and

¹² See, for example, Contributions, Matrimandir Agenda, 1980, 14.

¹³ Ciconesi and Ciconesi, 2012, ii-vi.

agriculture – in Sections B to G. In terms of urban infrastructure development, the drive to build the ‘city’ was catalyzed from the late 90s, post the passing of the Auroville Foundation Act, 1988 (‘AVF Act, 1988’) when dedicated Central Government Plan Grants for town planning began to flow into Auroville. Another impetus at this time was the growing concern to consolidate and safeguard acquired lands that were scattered across Auroville’s broader ‘bio-region’. Consequently, in 1999, Aurovilians – organized now as the Residents Assembly under the AVF Act, 1988 – drafted and published a Masterplan which was formalized through inputs by the Town and Country Planning Organization, Government of India (‘TCPO’) in 2001 and published in the Gazette in 2010. We consider the process that led to the adoption of the Masterplan, and its place in Auroville’s planning landscape in detail in section (iii). The publication of the Masterplan in 2001 set into motion the creation of a multitude of planning bodies, community participation endeavours, commissioned studies and plans to realize varied parts of the envisioned city, a process that continues till today. Before we review the Masterplan and effort towards its implementation, it is useful to outline the major approaches to planning, the ideological canvass as it were, that underlie this period.

ii. Four Orientations to Planning

Through these attempts at city-building from the 2000s to the present, the central challenge has been materializing key elements of the Galaxy plan while respecting the ecosystem built through the first wave of green works and developments pre-dating the existence of Auroville. As a result, the literature shows varied, and not necessarily mutually exclusive, approaches to the development of Auroville. Some cohere strictly to the Galaxy model, others consider it outdated and most are located on the spectrum in between advocating minor to major alterations. In general, four distinct sets of priorities emerge from the records, which have vied for planning attention. These may be roughly summarized, indeed caricatured, as follows:

Following the Galaxy plan, with an urban design focus: this first approach argues that Anger’s Galaxy concept concretizes Mother’s vision for Auroville – every element is carefully thought through by the Mother and is symbolic of the higher aspiration of collectively manifesting the Divine. A practice of urban design preserving the shape of the Galaxy is therefore key to kickstarting Auroville’s development, and must be the first port of call for Auroville. Many argue also that manifesting the Galaxy, which embodies the sacred geometry of Mother’s symbol, will attract the necessary financial capital and human resources.

Following the Galaxy framework, with a move from visually exciting to environmentally sustainable practices to accommodate ground realities: this approach argues that the Galaxy Plan is to be read as a guide and not as an instruction or diktat. Accordingly, there must be flexibility to modify it to suit environmental and geospatial concerns such as the preservation of environmental hotspots, ground and surface water collection, archeological finds, green cover, human settlements and so on. In some versions, this also includes the belief that Mother’s Galaxy vision is distinct from Anger’s 1969 Galaxy model. An understanding and preservation of the Mother’s ideals and vision underlying the Galaxy vision should thus be prioritized over replicating the model. For example, the Land Suitability and Land Use Proposal Study

commissioned by the Town Development Council (TDC) in 2014 details how the technique of building the Galaxy Model created a pronounced visual and aesthetic characteristic:

A model of this concept was presented to the Mother for her blessings. The galaxy proposal was built into a model that was to scale in terms of the horizontal plane or x-axis, but in order to create a visual/tactile experience, the built volumes were exaggerated on the y-axis; tweaked to 3-4 times the actual scale, providing a visual appeal that a real-scale model could not have captured. This animation, with visual enhancement, uses cultural-spiritual-mental imprinting to connect through association, in the minds of most people, the celestial imagery of the skies, stars and galaxies with vastness and movement, communicating a sense of the ‘future’ and ‘spiritual’ at the same time. Thus, this model as a concept for the city was a success in visual branding and promotion.¹⁴

Since 2001, various calls have been made along these lines to shift from development that is ‘visually exciting’, i.e., from the visual enhancement and appeal of the Galaxy Model, to ‘environmentally responsible’, where some of these features are reinterpreted or replaced to account for realistic urban planning.¹⁵ A series of debates thus ensue on the appropriate method to integrate the geometry of the Galaxy with ground realities, with proposals across the spectrum, some ‘tweaking’ the Galaxy model, whilst others substantially reinterpreting its framework. As the Town Development Council’s 2013 Development Plan notes, the key challenge in urban planning in Auroville is as follows: ‘the urban design with a Galaxy shape is a symbolic aspect of this vision and need to be integrated with the geophysical reality and the socio-economic development aligned with the original vision of the Mother.’¹⁶

Following the Galaxy plan, with a focus on socio-economic development: the approach shifts focus from the urban form to socio-economic concerns, particularly as the economic stagnation and housing shortage became chronic in the mid to late 2000s. This shift in emphasis means that the first port of call for the development of the ‘city’ is to be economically self-sufficient and to achieve cultural growth in quality, not quantity.¹⁷ In this, some argue that Auroville must perfect its socio-economic system at its current, small scale, whilst others locate the challenge in reaching sufficient economies of scale. In either approach, whilst the Galaxy plan is central to Auroville, it is not the immediate focus – its manifestation must be preceded by a stable socio-economic base. This includes a focus on promoting new economic enterprises, increasing capitalization etc., which is urgent given the financial dependence on donations and grants, contributions being limited by the small-scale industry. An aligned set of views look to developing the necessary social architecture organically, rather than front-ending the manifestation of the Galaxy with time-bound / ‘rigid’ plans, with the long arc of community processes and consciousness raising of the population dictating future development. These views supplement the thrust towards economic self-sustenance with streamlining the organizational structure, deepening participatory processes along with setting targets (of variable ambition, usually low) to bolster population growth, leading in time to the

¹⁴ Land Suitability and Land Use Study, 2013, 8.

¹⁵ Land Suitability and Land Use Study, 2013, 8.

¹⁶ TDC, Annual Development Plan, 2013, 3.

¹⁷ TDC, Annual Development Plan, 2013, 3-4.

manifestation of the Galaxy. The socio-economic settlement of Auroville, as an organic expression of the community, precedes – a pre-defined architectural vision to be built immediately, or as soon as possible.

Replacing the vision for a city with that of an eco-village: finally, a fourth approach, standing somewhat separate from the rest, focusses on the historic efforts at land regeneration have led to the growth of a flourishing ecology, which hold several environmental and health benefits for Aurovilians and the larger bioregion. The environmental concern, voiced across the board, including in the earlier approaches, predominates in this articulation: some have argued that as the lands of Auroville have been diligently cultivated, nurtured and protected over decades by appointed stewards, any attempt at at-scale urbanization would involve letting go of some of this green cover and may result in an unmanageable influx of population. This, some argue, would threaten the ecological and stewardship realities on the ground, as the ecology of the region cannot support a population to the tune of 50,000. Accordingly, the thrust of the argument appears to be that spiritual imperative of environmental conservation, particularly given global ecological crises, the range of socio-economic concerns that accompany high-density urban environment and the sensitive ecological balance of Auroville's geography, must take precedence over the fifty-year-old Galaxy concept that was drafted with minimal consideration of ground realities. While it reflects the architectural imagination of the time, some argue that it is now outdated. Proponents of this view resist at-scale urbanization and infrastructure development along these lines, though views are often on a spectrum, proposing instead – in some versions – a vision for Auroville as a sustainable eco-village, with low population density and built-up area, absent characteristically urban features.

Naturally, these short descriptions do not reflect the depth and texture of the planning dialogue. In most cases, views are held along a spectrum. Yet, the various phases of development since 2001 have seen each of these orientations to planning interface with others, clashing and collaborating to reveal challenges and opportunities in the process of planning Auroville. We consider the relative weight of each of these approaches for urban planning in Sections (iv)-(ix). Before addressing that issue, we the process that led to the 2001 Masterplan, which forms the framework within which these planning conversations are to be had.

iii. Review of the Perspective Masterplan, 1999-2001

Prior to the 2000s, populations numbers being limited (less than 1500), community reflection and decision-making unfolded in small, informal and unstructured groups, with weekly 'general meetings.' Participation in these groups was relatively high given the closely-knit ethic of the community based largely on personal contact and the absence of electronic devices, which made physical gatherings the only mode of social interaction. Interest groups had already taken shape by point this, lobbying for certain developments over others, but given the sparsely populated landscape and the uniting ecological imperative of the times, developments appear

to have proceeded independently in a semi-autarchic ordering of the collective without much of a shared ‘urban’ vision.¹⁸

By the turn of the century, economic liberalization reforms had begun manifesting their effects in India and in nearby Pondicherry. By many accounts, a distinct shift in demographics followed. The newer residents’ motivations set them apart from their predecessors who had tilled the land and rejuvenated it, by then, into a massive green forest, and many of whom had experienced a different Auroville guided by the physical presence of the Mother. Residents entering Auroville after the 2000s, in this view, were products of an economically liberalized age which had deepened problems of urbanization in distinct ways: many saw Auroville as a means of escaping the cacophony and clutter of cities, with a variable pull to the ideals of Auroville, often not defined in characteristically urban terms. Whilst a more robust survey would be required, anecdotally, it appears that this altered the push-pull dynamics that regulated earlier migration in subtle yet distinct ways. The first-hand experience of the philosophy and ideals of the Mother and Sri Aurobindo, many older conversants noted, remained concentrated in a stronger sense with the ‘pioneers’, a perhaps unsurprising phase in the evolution of any collective as time and distance from the original inspiration increases. Interestingly, as a result, participation in community affairs began reflecting the values of this new community with different motivations and aspirations: the records from the mid-1990s onwards exhibit a constant refrain that Auroville is ‘moving away from its ideals’, with calls for a realignment with the vision. Some also argued, as we discuss in Part III.F, that Auroville took an insular turn post the 1990s, particularly in the post-liberalized India that offered new opportunities and challenges, many of which landed at Auroville’s doorstep with the growth of Pondicherry with a pressing urgency to respond or be engulfed in the tide: one can see this in the slow population growth rates – a marker, as we discuss below not of the absence of aligned individuals in India or globally, but an insufficient pull from Auroville – and a distinct shift in the planning documents at the time from an integrated approach characteristic of the early years to a more defensive or disconnected one, both in relation to the region and the world at large. The emphasis on manifesting the urban form of the Galaxy, though reflected sporadically in the archival records, was not a priority at this time. Indeed, not un-often one encounters a marked indifference, or resistance, to it. As the AVF Act came into being in 1988, a new push to institutionalization came, particularly in the statutory mandate of the Governing Board in Section 17(e) to ‘to prepare a master-plan of Auroville in consultation with the Residents’ Assembly and to ensure development of Auroville as so planned.’

We discuss the AVF Act, 1988 particularly the relationship between the Governing Board and the Residents’ Assembly, in Part IV, but a brief note is relevant here insofar as early planning dynamics are concerned. The Residents’ Assembly, comprising all adult residents of Auroville, was tasked under Section 19 with envisioning and coordinating all activities in Auroville including the preparation of the Masterplan for approval by the Governing Board. The Act brought a fresh, and much needed, wave of institutionalization amidst the loosely organized collective, with an incipient organizational framework for legislating and executing key decisions, hitherto undertaken in a culture of small-group democracy within relatively

¹⁸ See, for example, Shinn, 1984.

unstructured frameworks and serious human resource constraints, particularly in professional fields under-represented in the migration or entry patterns from the early days till today. The earlier informal ‘community meetings’ came now to be formalized under the Residents’ Assembly, with its Working Groups. This spurred action in the community, not so much it seems to self-organize in new ways, but to prepare for the arrival of the Governing Board, a new and unknown entity. Unsurprisingly perhaps, it was an external stimulus, rather than an internal one, that moved the community to action with a spate of planning seminars and conferences in the early 1990s.

Coupled with the slow rise in population, the altered dynamics of the community and by many accounts, a hibernation of the urgency of the urban ideal or of growth, planning conversations began to reflect a divide between those who insisted on a push to urbanize, build and densify and others who either cautioned against unchecked growth or in some cases, seemed content with the trajectory. A resistant and slow shift began from the first phase – that of the environmental imperative – to the second one – that of a sustainable urbanism. That which was sought to be left behind – the urban – now came calling. The environmental works of the early years allowed, indeed necessitated in some sense, a focus on non-urban concerns to build the material base; yet as these monumental efforts yielded fruit, the need to push to the next stage emerged. The call for this shift intensifies in later years and, as we see below, defines Auroville’s contemporary governance concerns.

As the complexity and full force of the urban and socio-political tasks started coming, slowly but surely, to the fore, the organizational structure and ethic of the early years, valuable for its time, was placed under pressure. The Residents’ Assembly began acquiring political characteristics. While we were unable to locate reliable attendance numbers for the early years, conversants noted that complex coordination and reporting processes disincentivized participation, with a common complaint that the result was dominated by a select few community members who had the interest, capability or technical expertise to influence matters of community life. This led to a perceived exclusivism that further disincentivized participation as there was no value seen in a process where decisions already seemed to be pre-determined. The archival records show, at this early stage, signs of group-based lobbying dynamics and a democratic-technocratic divide. Insofar as planning is concerned, this meant that a cohesive vision for the ‘city’, let alone a concrete development plan, was yet a tall order. This pattern has, as we discuss below, intensified over the years, manifesting itself in a strong resistance to centralization of authority, professionalization of Working Groups, a popular under-appreciation of the Masterplan, the inability or unwillingness to produce a Detailed Development Plan and, in general, a fairly unsystematic approach to city-development absent a unified vision.

It is against this backdrop that the process of the development of the Masterplan process unfolded from 1999 to 2001, with a first plan developed by the Residents’ Assembly in 1999, subsequently modified at the request of the Governing Board with the help of planning experts in the Central Government, and approved in 2001.

a. Residents' Assembly Integrated Master Plan, 1999

In 1999, the Residents Assembly produced the 'Auroville Universal Township Integrated Master Plan – Phase 1'. This was primarily done as an 'appeal to the Government of India, to take all possible steps to safeguard ... the lands of Auroville', rather than as a move to urban planning.¹⁹ The Minutes of the Residents' Assembly meeting on July 28th, 1999, where the draft document was considered, provide an insight into the thinking of the time.²⁰

At the time, the Masterplan was labelled a 'land use plan' with 'land protection processes.' Then, and surprisingly now as well, the Masterplan was seen not as a planning instrument but simply a document that would help secure and protect acquired lands from encroachment and non-congruent development given the pace of economic growth and urbanization in Pondicherry and the bio-region. The minutes of the July 1999 meeting clarify the intention:

Guy also explained how the proposed document came to be called a 'Masterplan' as opposed to a 'Land Use Plan', as originally intended. First, this is the terminology accepted and understood by planners for whom a land use plan is already the first stage of a master plan. Second, the Auroville Foundation Act refers specifically to the adoption of a Master Plan. And third ... in order to be able to use the document as a basis for any kind of protective mechanism for the designated Auroville Township area, it has to be ratified as Master Plan. It was also clarified that the document actually is aimed more at protection of the Green Belt and, apart from zoning, does not give any detailed proposals for the development of the City Area. A more detailed planning will be an ongoing process [in which] ... all interested are encouraged wholeheartedly to participate.²¹

Securing the Auroville lands required a formal plan for the 'city' to activate government channels. Since community members did not see it as a planning instrument to collectively steer Auroville's development, it was not, despite the name, a masterplan proper. The plan at this stage reflects environmental concerns and bio-region outreach/ employment generation as priorities, without consideration of city-building or urban infrastructure itself. It encoded the key elements of the Galaxy Model discussed above (four zones, the Crown, Lines of Force and the radials), with associated plans for the bio-region, but did not propose development regulations, land use proposals, zoning regulations etc. In this, key development decisions were deferred to a later date. It was seen as a 'preliminary document – a tool to start', 'a refinement of the original plan of February 1968 approved by the Mother'.²² In brief, the 1999 Masterplan provides for the following concerns:

- i. It emphasizes a regional focus in a bid to validate 'legal protection of the designated Auroville area from speculation and real estate development ...' and therefore

¹⁹ Minutes of the Residents' Assembly Meeting on July 28th, 1999, 2-3.

²⁰ We note here also that there was no practice at the time for a formal transcription of the debates or a record of attendance. These are yet to be implemented today, to the best of our knowledge – this is an important and easily achieved procedural requirement for the smooth conduct of debates in the Assembly, and for reflection and accountability of views. We consider this, and other suggested changes for the effective operation of the Residents' Assembly, in Part IV.B.

²¹ Minutes of the Residents' Assembly Meeting on July 28th, 1999, 1.

²² Minutes of the Residents' Assembly Meeting on July 28th, 1999, 2; Minutes of the 20th Meeting of the Governing Board, 1999, 2.

proposes to create in collaboration with the Government of India a masterplan for Auroville, an Extended Area Partnership Plan ('EAPP') and a Bioregional Partnership Plan ('BPP'). The EAPP proposes the development of 40 sq. km. of villages within and around the Auroville township 'identified as critical ground water re-charge areas', to assist socio-economic development and 'maximize ground water re-charge', reflecting the priority of environmental concerns of the time. The BPP is proposed for the economic and environmental development (watershed management) of the bio-region that covers 800 sq. km. around the Auroville Township.²³

- ii. For the most part, the plan documents the progress made in Auroville as of 1998-99 in relation to infrastructure development in the four zones, Matrimandir, housing, land regeneration and bio-region village development.
- iii. Along with the regional plans it proposes an investment of Rs. 200 crores over a ten-year period to be made in infrastructure development (water, sanitation, energy/power, telecommunication, solid waste management, etc.) across all four zones, with special focus on the Industrial Zone.
- iv. There is a recognition of the challenges and opportunities of economic self-sufficiency in Auroville given the absence of 'normal self-financing mechanisms through taxation', no ownership of land and the 'important role' commercial units can play in becoming 'a self-supporting town'. However, the plan does not elaborate proposals to expand and optimize the participation of commercial units in income-generation. There is also, as we discussed in Part I with our cautionary comments, a sense that the financing of Auroville will be taken care of by a higher force and that 'any planning and projection on financing has its limitations.' The estimated Rs. 200 Cr. investment is proposed to be met by the 'future growth of Auroville and its population, attract[ing] increased funding from varied sources'.²⁴
- v. The plan discusses funding expected under the European Commission's Asia Urbs Programme by the end of 1999, which aimed to improve urban management and service delivery in Auroville through a 'combination of buildings, equipment and human resources' and proposed a centre of urban affairs (services, management, development, and planning). Funding under the Asia Urbs Programme lasted till about the mid-late 2000s.
- vi. A concern for development in the bio-region, with the clear understanding that the villages in the plan area are to develop collaboratively, and that 'no displacement is intended ... [We] have no intention to govern or force any particular action or restriction in these villages.' In this, an important point is registered for a

²³ Auroville News, July 1999, 1; Minutes of the Residents' Assembly Meeting on July 28th, 1999, 1-3.

²⁴ Auroville News, July 1999, 2.

bioregional planning framework or a ‘partnership plan’ (still undeveloped today, despite multiple attempts): ‘It was pointed out that it is much more complicated than it sounds to ‘involve the villages’ in the planning process, as local politics and economic factors create conditions that are far less than optimal. The villagers will welcome, simply for economic reasons, many types of development that, for Auroville, are undesirable. We will have to find ways to meet both sets of needs. However, that it is neither healthy nor possible for Auroville to develop in isolation, is something that more and more of us understand, and this, at least for those working in the field, represents a historic turning point in Auroville’s development consciousness.’²⁵

- vii. A recognition that a *collective* process to secure the lands, and build the city, is required (a constant refrain in planning documents since, given persistent legislative disagreements and slow, to no, implementation of collective measures, as opposed to individual initiatives): ‘it is very much time, perhaps critical, to demonstrate that we are capable of taking a collective step towards conscious development. For whatever reasons, Auroville’s history to date has failed to secure the land ...’; ‘Perhaps at this time we could manifest a collective will to succeed.’²⁶ It seems also that this point, as the minutes of the subsequent meeting of 7th August, 1999 note, that an amount of Rs. 40 crores had already been requested from the Government for land purchase (NB: this amount did not materialize, but we were unable to locate archival documents or testimony on why this was the case.)
- viii. A proposed suggestion to the Governing Board to set up a local municipal authority for Auroville.

With this limited understanding, the 1999 Masterplan was approved on 28th July, 1999. Interestingly, this meeting was attended by ‘about 100 people’, or approximately 7% of the population at the time (with all but one voting in favour).²⁷ This indicates a low rate of community participation within the Residents’ Assembly’s own planning process at the time, key to the development of the shared city. Interestingly, a call was also made at this meeting for residents to provide feedback to the ‘Functional Residents’ Assembly Meeting’ proposal, given low rates of participation. As we discuss in Part IV.B, the pressures of a direct democratic setup at scale were apparent at that point, and have intensified since, rendering the functioning of the Residents’ Assembly problematic. Anecdotally, it appears that this lack of engagement extends today as well to the Perspective Masterplan, which we discuss below. Only a few residents seem to have read the document. This is a worrying sign if a model of deliberative democracy – which demands an informed collective, as we discussed in Part I – is to be operationalized with some regard to efficiency. As we discuss in Part IV, decentralized, direct

²⁵ Auroville News, July 1999, 2-3.

²⁶ Residents’ Assembly Masterplan, 1999, 3.

²⁷ Auroville News, July 1999, 2.

democratic systems absent collective engagement have led to dissipation and ineffective decision-making in Auroville's planning process.

Alongside the passage of the draft Masterplan, two 'executive' bodies were constituted.²⁸ It appears that the Residents' Assembly was, at this time, as indeed today, both a legislative and executive body. As we consider below, and in Part IV, this conflation requires reconsideration today for a wise distribution of governance labour and effective implementation of policies. The two bodies were:

- i. A 'task force', or the Land Use Plan and Land Co-Ordination Group, comprising those who prepared the masterplan to 'continue the work'. The community was requested to 'trust that this group, on the basis of its experience of working together, is capable of knowing and selecting the right people for the necessary tasks'. It seems that no formal criterion or process for the selection of Working Groups had been established at this point. This executive authority, however, was constituted with the caveat that 'nothing will be agreed to by the members of this group that has not been agreed to by the Residents' Assembly.'
- ii. A 'Committee' comprising 18 residents (or approximately one-fifth of those present and voting), constituted to liaison with government authorities, secure funding, etc. Again, this overlap between executive and legislative domains indicates a nascent stage of governance structuring, owing to low population numbers.

b. Masterplan 2001 (Perspective: 2025) and Planning Hierarchy

The 1999 draft Masterplan was subsequently forwarded to the Governing Board for its approval under Section 17(e) of the AVF Act, 1988. The Governing Board (comprising notably Dr. Joshi, the architect of the AVF Act, 1988 and Anger), at its 20th meeting on the eve of Sri Aurobindo's 127th birth anniversary, 14th August, 1999 considered the Residents' Assembly plan. It noted:

While the Governing Board approved the Master Plan proposed by the Residents' Assembly in principle, the Board felt that comments and views of practising town planners in Chennai and Delhi should be obtained and incorporated in the document, before the Central Government is approached for notifying the same ...²⁹

Accordingly, the Governing Board approved the following two action-points:

Finalise detailed Master Plan in consultation with Delhi/Chennai Town Planning Authority [and] Attempts should be made to get the Governing Board of Auroville Foundation declared as the local development authority vested with the authority for planning permission [which we discuss in Part III.C below in the context of the long-standing proposal for a New Town Development Authority].³⁰

²⁸ Auroville News, July 1999, 23.

²⁹ Minutes of the 20th Meeting of the Governing Board, 1999, 6.

³⁰ Minutes of the 20th Meeting of the Governing Board, 1999, 6.

Subsequent to this suggestion by the Governing Board – a good example of mutuality in practice between the statutory bodies, key to the operation of the AVF Act, 1988, as we discuss in Part V – the Land Use Plan and Land Co-Ordination Group consulted various town planners and incorporated their comments in what came to be the 2001 Perspective Masterplan 2025.³¹ Again, this is a good example of an open interface with external experts, an area of concern in Auroville today in the context of the preparation of the Detailed Development Plan, as we discuss below. This is understandable as, as far as we are aware, the group tasked with preparation of the masterplan had one formally trained urban planner. Shoring up internal capacity constraints with the support of trained experts outside was welcomed, and indeed, the role of the Town and Country Planning Organization.

In a meeting of the Residents' Assembly on 18th December 1999, the amended draft Masterplan was discussed. It is worth reflecting on key points discussed then, as most are still unresolved today. The 1999 meeting provides historical context to the planning dialogue today:

- i. *On designation as the planning authority:* It was asserted that Auroville 'can rightfully ask to control [its] own destiny', including a proposal to designate the Auroville Foundation as the planning authority instead of the village panchayats, *only* if a masterplan proper is prepared, demonstrating planning capacity within Auroville. This debate on whether Auroville has the internal capacity to plan developments in the region, given chronic internal governance concerns and limited expertise in urban planning, continues to this day. We consider this below in our review of developments post 2001.
- ii. *On village relations:* There was a concern that villages in the plan area should not be isolated, or their residents treated as second-hand citizens. (The circles drawn around the villages in the first draft were accordingly removed.) This reflects a continuing concern today, with a notable outreach architecture in place, yet persistent concerns with integrated development and local relations.
- iii. *On securing the land:* The problem of increasing land prices owing to speculation was raised again, indicating that legal protection (for which a detailed masterplan is necessary) can disincentivize such activity. As we discuss in Part III.B, movement on land acquisition since 1974 was slow, and continues to remain a serious concern today.
- iv. *A shift from zoning / land protection to development goals, strategies and timelines:* A detailed introduction to development works conducted in Auroville till that time was introduced in the new draft, importantly now with development projections for the future. This was the primary change between the draft Masterplan approved on

³¹ The support of planners from the TCPO was publicly expressed in an open document circulated to the community dated November 27th, 1999, when the second meeting of the Residents' Assembly to discuss the amended Masterplan was called. *See*, Auroville News, November, 1999 ('We were also gifted with another visit by a retired Chief Town Planner with over 40 years experience and a lot of goodwill for the Auroville experiment, who gave us 2 full days of his time and very focussed attention.')

28th July and the second iteration, one that appears to have escaped the attention of many at the time: the plan was no longer only a skeletal articulation of the primary zones, with a view to protect the lands of the Auroville, but also a policy document indicating the development goals for the future, along with planning strategies to achieve them. This shift, though clearly articulated by the architect, Anupama Kundoo, who presented the amended document, does not seem to have registered in the public perception of the plan at that point, nor indeed at the time our research. It appears, amongst other things, to be the cause of much disagreement in Auroville's current planning conversation. At the time, Kundoo noted: 'information has been included on what has taken place in each area and how we see development continuing over the next 10 years (specifically requested by the consulting town planners). Section 3 attempts to outline a development strategy, describe our management capacity ... It was made clear to us that we had to include population projects, densities and a timeline, otherwise why should so much land be reserved for Auroville, given the increasing demands that are surrounding us.' This last concern, of under-utilization of land with low densities and an urban sprawl, is key: as we discuss below, it dents Auroville's aspiration to sustainability, hinders efforts to negotiate formal protection for its lands, disallows sufficient economies of scale and renders Auroville unrepresentative of other urban settlements which it is meant to guide.

- v. *On organizational structures:* A body called the Development and Planning Group was proposed at the time, as a semi-executive authority, still under the control of the Residents' Assembly, to take the development of the city forward according to the Masterplan, with an invitation to all interested to 'focalize' the discussion in that forum. This demonstrates an incipient recognition that the Residents' Assembly is a legislative body, and implementation and detailing of policy documents accepted by it must be located in appropriate executive bodies to allow for efficient management.
- vi. *On rigidity / organic growth:* It was understood that the Masterplan becomes a legal document and once finalised, 'we can't do something completely different than what's included in it. On the other hand, it's still pretty vague in most areas. It is understood that the details will be worked out 'as the underlying truth of the township emerges.' As we noted in Part I.D, this careful balancing of planned and organic development detailed in the seven-stage hierarchy of plans provides a systematic frame for creative growth, recognized right from the drafting stage. Unfortunately, no subsequent plans have materialized owing to this 'elephant in the room', effectively halting development works.
- vii. *Integrated development with Pondicherry:* A recognition that integrated development with the nearest major urban centre of Pondicherry is necessary, as both goodwill and money are available in that relationship. As we discuss in Part III.C, little to no movement has been registered on this front since.

Thus, the amended Masterplan was passed by the Residents' Assembly by unanimous vote. Unfortunately, the participation numbers ('around 60 people') *fell* to approximately 4% of the resident population, indicating again either a general lack of interest or ability to participate in the planning process. Perhaps owing to this, the amended plan was not widely read then (as now), leading to delays in the implementation of most development proposals and projections with debates uninformed by the document itself. Indeed, some conversants considered the Masterplan 'illegitimate', owing to the absence of community participation or the approval of the amended plan in 2001. This issue was discussed at the Residents' Assembly General Meeting in August 2022, with views expressed along these lines:

In 1999-2000, the community over a period of a year and a half drafted a Master Plan. Within a few months, that Master Plan, which is so important in the life of the community, was unceremoniously set aside. It was not set aside by any due process ... It was set aside by a group of four or five people in liaison with bureaucrats in Delhi who know nothing whatsoever about Auroville. And between them, they drafted a second master plan. That Master Plan is what (sic) hold today as the one that was gazetted. This community has never ratified that Master Plan. That was a lie ... So I think the first job, among others, for this RA is again, not to leave the Master Plan and its efficacy, which we had 20 years ago.³²

This sentiment is understandable, given the low participation rate of 4% – yet, the facts do not support this view. The assistance of the TCPO in amending the Masterplan was publicly stated at the Residents' Assembly meeting by members of the Land Use Plan and Land Co-Ordination Group tasked with drafting the document, and again in the public call for the second meeting on 7th December, later pushed to the 18th. A meeting with the relevant officials who visited Auroville that week was also announced as per the records. The public call in *Auroville News* dated 27th November, 1999 to discuss the amended Masterplan also noted that members of the Group will be 'very available to answer questions about it in the week before the RA' and solicited opinions from the community:

... if there's anything there you don't understand or think won't work, *tell us about it*, so that we can address your concerns and questions prior to the RA. We appreciate any enabling energy you can send us in the next days ... We strongly request your participation on the 7th. The more the community is behind the Master Plan, the better it will serve us, both inside and out.³³

The amended Masterplan was thus circulated, debated and agreed upon at the 18th December meeting. As such, the Residents' Assembly approved the plan after due process. That said, the renewed interest today to 'reclaim the Masterplan', given low participation and awareness of its amended contents at the time, is no doubt valuable, if delayed. As we discussed above, it is important to recognize that the Masterplan concretized key elements of the Galaxy, with development goals for social and physical infrastructure – it is *not* a development plan, but a policy document that retains flexibility in most areas, some of which are the bone of contention

³² Residents' Assembly, General Meeting, 2022, 34-5.

³³ Auroville News, November, 1999 (emphasis in original).

today. It requires further specification in all respect and as such, community participation today to define Auroville's urban future can operate within its broad parameters.

In sum, the Auroville Universal Township Masterplan, Perspective: 2025 ('the Masterplan') translated Mother's vision and the Galaxy Model into a planning frame. It was prepared by the Residents' Assembly, assisted by an executive body in consultation with external experts. It was approved by the Governing Board and the Residents' Assembly, which also approved the document, and subsequently by the Ministry of Human Resource Development, the nodal Ministry for the Auroville Foundation, on 12th April, 2001.³⁴ It was notified subsequently in Part III of the Gazette on 16th August 2010. The delay in publication appears to be related to legal concerns over the power and jurisdiction of the Ministry of Human Resource Development to notify the Masterplan. There is accordingly an open question as to whether the 'start-date' of the Masterplan was 2001 or 2010. Section 32(3) of AVF Act, 1988 notes that 'no regulation made by the Governing Board shall have effect until it has been approved by the Central Government and published in the official gazette, and the Central Government, in approving the regulation, may make necessary changes therein which appear to it to be necessary.' However, it is unclear whether this requirement – which pertains to regulations made under Section 32 – applies to the Masterplan, approved under Section 17(e). In any case, the publication was in Part III of the Gazette, which serves the requirement for public notice of decisions made. Insofar as the Masterplan was discussed in the community, approved by the Residents' Assembly, Governing Board and the Central Government, and publicly disseminated and available for access in Auroville, the notice function was served. Procedure serves substance, unless compelling reasons are presented otherwise. This legal technicality raised during some discussions – whether the clock on the Masterplan started running from 2001 or 2010 – is minor. The spirit of urgency to manifest would dictate that such considerations remain secondary.

c. Annotated Summary of Part I of the Masterplan

The Masterplan is divided into three sections. Part I outlines the existing scenario, Part II provides development proposals and Part III identifies zoning and development promotion guidelines. The structure of the plan reflects developments at the time: in 1996, the Central Government had commissioned the Institute of Town Planners to prepare the Urban Development Plan Formulation and Implementation ('UDPFI') Guidelines to improve the structures and processes concerning master-planning in India. The Governing Board's suggestion thus presented a timely case for the TCPO to assist the Residents' Assembly to draft a masterplan for Auroville in line with the UDPFI Guidelines. Importantly, the Masterplan prepared was a *perspective* plan which meant that it was to lay down *directions* for growth and development: it was a broad policy document, rather than an urban development plan. It therefore provided basic development proposals for population and economic growth and physical and social infrastructure, along with development control regulations (a guide to zoning), leaving all else, indeed the entirety of development detailing and planning work, open for Detailed Development Plans to be prepared in the future. Prof. Joshi's Preface to the

³⁴ See, Minutes of the 20th Meeting of the Governing Board, 1999, 6 ('The Governing Board felt that no purpose be served unless the Master Plan is notified by the Central Government.')

Masterplan, in his capacity as Chairman of the Governing Board, outlines the five keynotes of the document.³⁵ There are:

- i. The centrality of the Galaxy Model (discussed in Part II, and *in passim* below).
- ii. The need for orderly, planned and systematic development of Auroville (discussed in Part I, and address *in passim* below).
- iii. Prevention of any non-conforming developments in the bio-region and integrating the neighbouring rural regions (discussed in section (vii) below, and in Part III.C).
- iv. The need for sustainable urban development, maintaining an overall green cover of 50% with the Green Belt (discussed in Part II and *in passim* below).
- v. The defining character of Auroville as a ‘Centre for Advanced Research’ (discussed in Part III.E).

The Masterplan is an important document that serves, first, as a framework for city-development, second, as an overview of urban development activities till 2001, and third, as benchmark to measure progress since, which we consider across sectors in this Part. Accordingly, we provide an annotated summary of Part I of the Masterplan here, to understand developments as of 2001 and flag issues of relevance alongside that serve to assess progress since.

In the ‘Preamble’ and ‘Origin of the Township’:

- i. the Masterplan is important to regulating and channelising the growth of Auroville. (para. 1.1.1) [**NB:** The need for structured and planned processes to organize the growth processes, an emergent concern in the 80s and 90s, is clear and repeatedly emphasized. It continues to be a matter of concern in Auroville today. We discuss the practical implications of the debate between planning and organicity on governance practices in Part IV.A, to allow for flexibility yet avoid dissipation.]
- ii. it was prepared on the lines of the UDPFI Guidelines, with four inter-related plans envisaged – Perspective Plan, Development Plan, Annual Plan and Plan of Projects, in descending order of particularity. (para. 1.1.1) [**NB:** The development plan, annual plan and plan of projects have not been not drafted till date, leaving the UDPFI guidelines and proposed planning strategy unmet.]
- iii. it is a policy framework, and not a detailed guide to development itself. (para. 1.1.2) [**NB:** The Masterplan is a land use plan and a policy guide, not a masterplan proper or a detailed development plan that can guide actual construction or implementation – this is an important and under-appreciated concern.]

³⁵ Masterplan, 2001, 5-6.

- iv. the town is dedicated to the vision of Mother and Sri Aurobindo. (paras. 1.2.1-10) [NB: Being a broad policy document, the Masterplan naturally does not go into details here. Yet, as we outlined in Parts I and II, it is the translation of their vision, often articulated in abstract or general terms, into concrete forms where the challenge lies. We discuss the place of Mother and Sri Aurobindo's thought in Auroville in Part IV.E]

In 'Location and Regional Setting' and 'Climate and Physical Characteristics':

- i. that initially 'the site was a barren plateau traversed by dry canyons and gullied land with hardly any vegetation', the 'land is generally of poor quality for agriculture and the entire area was identified as a backward area.' (paras. 1.3.1-2), and the 'soil is not suitable for productive agriculture with traditional methods. This was also assessed by the District Officer in 1976, who concluded that 'the entire area is exposed to wind and water. If this is allowed to continue, then agriculture will be impossible ...' (para. 1.4.3) [NB: The pioneering ecological work to lay the foundations for the city is now internationally acclaimed. We discuss this in Part III.G. The developmental effects in the bio-region too are substantial, though much work remains to be done. We discuss this in Part III.C]
- ii. the village settlements of Edayanchavadi, Irumbai, Kottakarai, Rayapudupakkam, Pettai and Alankuppam, with a population of 8000 in 2001, are in the plan area, and those of Kuyilapalayam, Acharampattu and Oddampalayam, with 3000 persons, on the periphery. (para. 1.3.3) [NB: A regular population census and socio-economic mapping are required to update these figures for structured regional planning. We consider the need for evidence-led regional and outreach planning below, *in passim*, and in Part III.C.]
- iii. the proximity to the urban centres of Pondicherry, Tindivanam and Cuddalore, with whose development 'Auroville's development is closely linked' and that, given existing developments in Auroville, 'the development models evolved in Auroville township, be it plantation, regeneration of land, water harvesting, building technology, etc., are benefitting the entire region.' (paras. 1.3.3-4) [NB: The INTACH-PondyCan report, and others, point to the need for a robust regional planning framework, which is yet to be operationalized. Failing this, unstructured growth is inevitable, bringing unmanaged urban pressures into Auroville. This is a neglected concern in Auroville's planning efforts.]
- iv. the 'inhospitable site' is being turned into a 'hospitable environment for the development of a human settlement in harmony with nature', and that 'constraints, in the form of gullied, windswept barren lands generally considered unsuitable for urban development, have been used as opportunities for evolving the form of the township.' (para. 1.4.5) [NB: This points to an early indication of the need for creative ways to develop the terrain with the Galaxy plan. We consider this in the context of the Crown below in section (ix) below.]

In 'Existing Land Use':

- i. that the barren and marginal lands purchased in 1968 have since been turned productive, 'entirely through the efforts of Aurovilians.' (para. 1.5.1) It notes that the 'early residents with their hard work in collaboration with villagers' have regenerated the land for urban and green uses, with check dams and bunds to build the soil and over 32 million trees planted. (para. 1.5.2) [NB: Again, the exemplary early work is recorded, and the notable collaboration with surrounding villages. As we discuss in Part III.C, the existing outreach and regional planning architectures requires systematic and evidence-led planning going ward, particularly as bio-regional demographics respond to Auroville's development and that of surrounding areas.]
- ii. that, as of 2000, 12% of the land (232 hectares) is developed for urban use, and 88% is under agriculture, plantation and non-urban uses (1731 hectares, of which approximately 1000 hectares, or 57%, is dedicated to agriculture and 600 hectares, or 35%, to land regeneration / forestry). [NB: This reflects the priority in the early years for ecological restoration. The phase shift to sustainable urbanism, necessary and inevitable, requires a conscious recalibration of governance frameworks and community dialogue. This is a long-standing fault-line in Auroville's development debate, as we discuss *in passim* below.]
- iii. in terms of the urban area,
 - a. for housing, it identifies 95 residential communities (with the smallest at 3 and largest at 80 units), some outside the plan area occupying 100 hectares, or approximately 43% of the urban area (para. 1.5.3(b)) [NB: A large resident population outside the plan area is worrying, then as now. Moreover, spread out residential communities can, and have in subsequent, years led to a sprawl. We consider this in Part III.D.]
 - b. for commerce, manufacturing, public and semi-public (such as schools, health facilities etc.), administrative and institutional, and recreational uses, short descriptions are provided. (paras. 1.5.4-8) [NB: These indicate a nascent development of urban services and a proto-urban environment. The growth of these activities since has been slow and unsystematic, as we consider below *in passim*.]
 - c. for roads, it notes that there are temporary gravel and mud roads providing access to various facilities/settlements in Auroville, some of which will be replaced once the planned roads are built.' (para. 1.5.9) [NB: The replacement off temporary gravel and mud roads with permanent and planned ones, including the preliminary step of marking the right of way, has witnessed delays and resistance, despite several attempts by the Governing Board, TDC, Working Committee and Infrastructure Co-ordination Group. We discuss this below in section (ix).]

- iv. in terms of the non-urban area,
 - a. it notes the exemplary land regeneration work done by Aurovilians, which ‘have modified the stark landscape ... [and have] restored the land for productive agriculture by preventing soil erosion. (para. 1.5.10) [NB: As above, this is a singularly important achievement.]
 - b. short descriptions of the agricultural activity (without numbers on production or nature) are provided, with reference to Auro-Orchard and Pitchanidkulam. (paras. 1.5.11) [NB: This indicates, based on supporting testimony, a basic agricultural setup, but absent data, it is hard to evaluate the sector at that point. Some testimony also indicates that not all farms followed organic growing methods due to local pressures. We discuss agricultural and food security concerns, now pressing given a rapid change of land use patterns in the bio-region and a largely import-dependent food sector, in Part III.G]
 - c. the local environmental resources are identified, and the need for planned development is emphasized given the sensitive environmental balance of the area. (para. 1.5.15) [NB: Given the sensitive ecological environment, and the changed landscape developed through green works, this is an important consideration which requires a thorough environmental audit to be conducted to map energy flows, biomass utilization techniques, ground-water recharge and protection etc. We do not review energy and water concerns in this study. However, as we noted above, an audit can allow for an environmentally-sensitive development and avoid sporadic, local actions. Naturally, the green cover in some areas will necessarily reduce: as long as this is done to maintain the overall green cover, and protect essential ecology flows through a planned approach, this is inevitable in the next stage of Auroville’s growth. As we discussed in Part II, an ecologically sensitive urbanism is the ideal, for which conscious and careful planning is necessary as urbanization picks up pace in Auroville and unchecked development in the region places pressure on shared ecological resources.]

In ‘Demographic Characteristics’:

- i. it notes that ‘the normal process of demographic growth does not apply to Auroville’ as only those who aspire to be willing servitors of the Divine consciousness can be admitted. (para. 1.6.1) [NB: This is a critical point, given slow rates of population growth since. Alignment with the vision should not translate into unduly high entry barriers. This requires strategic outreach and upon entry, a robust network of acculturation practices. We discuss in Part IV.E.]
- ii. it notes a 374% increase in the population from 1972 – 2001, from 320 to 1519 (with 2.5 lakh casual visitors a year) with a 12% increase from 1998-99 (para. 1.6.3). The gender ratio is low at 881 women to 1000 men. 70% of the population is in the active age group, with 20% school-going children and 6% above 60 years.

42 nationalities are represented, with 12 nationalities above 20 residents and 67% concentrated amongst Indian, French and German residents. It notes, however, that the ‘population growth till now has been rather slow.’ However, it anticipates that ‘since a critical mass has already been formed and the development activities are picking up, Auroville will attract a large number of people from various countries in the years to come. In this context, it may also be mentioned that a number of international centres have been set up in different countries, and it is proposed to set up similar centres in the different states of India. These centres will disseminate information about Auroville, thereby raising awareness and attracting resource persons in larger numbers for the expansion of the present activities of Auroville.’ (para. 1.6.4) **[NB: Growth rates are chronic concern, with diseconomies of scale, lagging intensity and diversity in the collective etc. We discuss these in section (iv) below and in Part IV.E.]**

- iii. it estimates approximately 1200 researchers annually. (para. 1.6.5) **[NB: this is a high and notable figure; however, details are not provided. Our guestimate of numbers today is much lower. The research landscape requires a fresh impetus, as we discuss in Part III.E.]**
- iv. it estimates 850 working residents, with 85% in services and manufacturing and 15% in rural and agricultural work, with 5000 day-workers from nearby villages (a 1:5 ratio of Aurovilians to day-workers), with a higher than usual participation of women in the workforce at 48%. (para. 1.6.6) **[NB: as we discuss in Part III.C, work on women’s empowerment and employment in the bio-region has been a great achievement, though poverty, employment and socio-economic concerns remain. As we discuss in Part III.F, evidence-led planning to develop the local socio-economic infrastructure is a difficult and long-term task that requires a fresh impetus and defined organization, not only through private enterprise but in liaison with the Tamil Nadu State Planning Commission and local administration.]**
- v. it notes the absence of specific data on occupational structure (para. 1.6.9) **[NB: this continues to be a concern, with the last survey conducted in 2000. We discuss this briefly in Part III. F.]**

In ‘Economy of the Township’:

- i. the priority of agriculture and land regeneration efforts, with the economy comprising approximately 100 small to medium scale manufacturing units and services, with marginal employment in the commercial sector. (para. 1.7.1) **[NB: as today, the commercial profile of the time comprised labour-intensive, small-scale units. This raises structural concerns that we discuss in Part III.F.]**
- ii. the production comprises computer software, electronic and engineering products, equipment used in alternate and appropriate technologies such as windmills, solar lanterns and heaters, and biogas systems, with cottage type industries producing

garments, candle and incense products etc., whilst services comprise construction and architectural services, research and training in various sectors related to efficient resource management. The overall turnover at the time is Rs. 25.5 crores. (para. 1.7.2-3) [NB: This reflects a modest turnover at the time, with low capitalization, insufficient for growth and re-investment. Auroville exempted itself, in a sense, from the post-liberalization benefits and challenges. We discuss this in Part III.F in relation to structuring Auroville's productive sector as a research-intensive knowledge economy. The development of alternate energy systems, early entry in software, electronics and engineering was a notable movement, yet the trend has not continued. Seven of the ten enterprises listed by name, do not seem to be surplus generating enterprises. We are unsure of the reason behind their inclusion.]

In 'Housing':

- i. there are 767 housing units, comprising individual dwellings, community housing, apartments and youth hostels, with an average household size of two (adding up to 1534 residents plus minors) (para. 1.8.1). [NB: Detailed housing figures are not provided. Pioneering works in architecture – individual and community housing, and apartments – are well-documented and internationally acclaimed. Particularly given the absence of a supporting infrastructure, local expertise or labour at the time, this is a great credit to those in the sector.]
- ii. Other documents indicate early signs of a sprawl, with approximately 30 communities with an average of 20-30 residents, which has intensified today. The Masterplan records experiments made in appropriate construction elements, including stabilized earth blocks, rammed earth, fire bricks etc., which 'will have far-reaching implications in terms of design and materials, of reduction in energy consumption.' (para. 1.8.2). [NB: These again are notable developments in the sector, which placed Auroville's architecture and construction practices in a leading space, with projects and consultancy services undertaken in other parts of the country. An expansion of the research infrastructure to leverage existing the knowledge-base for growth carries great potential, to offer services to the world, generate revenue and attract aligned newcomers. We discuss these in Part III.D.]

In 'Physical and Social Infrastructure':

- i. a limited road infrastructure, of 23.7 kms, which are tarred but narrow, not well maintained and mostly of a temporary nature. The road network comprises an inner and outer road, connected by radial roads, with the surface of most roads kept as gravel to allow percolation of rainwater. Apart from missing links in the outer circular road in the eastern part of the township, the road network in the township is devoid of street furniture, signage and indicators, which need to be improved. The roads are maintained for pedestrian usage, but increasing slow moving traffic, including tourists, is pointed out as a concern. (para. 1.9.1). [NB: the mobility network is chronically under-developed today, with limited permanent road

networks, the rights of way unmarked, delays in laying down the service corridors on the Crown, increased and unmanaged vehicular usage. A city-wide mobility plan is key, as we discuss in section (ix) below.]

- ii. water supply is dependent on underground sources, with sixty wells of 3800 cubic metres per day. The groundwater situation is described as critical, with need for water management research and application. Pumping capacity for water is adequate to meet the demands of population growth, with one large overhead reservoir has a capacity of 1.5 lakh litres and 8 medium-size low-level tanks range in capacity from 10,000 litres to 40,000 litres. (para. 1.9.2). [NB: As we discuss briefly in Part III.G, the early afforestation work resuscitated the ground water table through check dams, percolation pits, afforestation, etc., Water management concerns, for household, industrial and agricultural use, are critical today, with over-usage in the region and the need for enhanced recharge. Several studies and proposals are available, yet a systematic approach to internal and regional water management is necessary.]
- iii. the drinking water usage is recorded at 4.5 million litres/day, which is considered excessive and measures are proposed to bring it down to ‘reasonable urban standards.’ (para. 1.9.3). [NB: We were unable to verify the implementation of these measures, or locate figures or studies on current water usage. This requires attention for future planning efforts, especially an anticipation of increased population numbers.]
- iv. all residential units have their own system for sewage disposal, with about 20 community-level treatment facilities (for residential as well as industrial and commercial units) consisting of septic tanks, Imhoff tanks, baffle reactors, and root zone and lagooning systems (the last being experimental, with tests for their efficacy underway). (para. 1.9.4). [NB: Considerable work was done in the early years on developing appropriate sewage systems. This is beyond the scope of our study. Naturally, as numbers grow, this will require a collective planning effort to organize sewage systems, and continue active research and documentation. This must ideally precede and guide new housing and industrial development.]
- v. for waste management, about 2000 kgs is organic and generally composted at the site itself, about 1000 kgs is recycled and the balance of 500 kgs is incinerated. The non-recyclable wastes of 400 to 500 kgs, are stored in a temporary storage facility until an acceptable disposal solution is found. (para. 1.9.5). [NB: We are not aware of whether solutions to this problem were found, though we have been informed that the local waste dump in Kuyilapalayam has been used with greater frequency. This is beyond the scope of our study. We can note the obvious: a city-wide waste management strategy is needed, with appropriate measures at the house, ward, zone and city-levels. This again requires prior planning, to avoid *ad hoc* solutions.]

- vi. for power generation, a consumption of 1.75 kilowatts / year is recorded from two Tamil Nadu Electricity Board feeders, with an approximately equal spread for residential and commercial purposes. In addition, about 150 houses (or 20%) use solar energy, with 140 solar water-pumping systems and 30 wind-driven pumps. (paras. 1.9.6-7). [**NB:** A review of Auroville’s energy systems is beyond the scope of our study. It appears that Auroville’s solar and wind energy systems seem robust with excess capacity for population projection, with an Intelligent Grid system piloted and plans for a citywide roll-out. We are informed that a city-wide energy systems analysis, including a yearly GHG emissions accounting system, is in progress. This is naturally key for planned urban developments.]
- vii. for outreach, two English-language (Auroville Today and Auroville Outreach), one Tamil (Kaliveli Nilam) newsletters are identified, with the note that ‘Auroville is equipped to handle its information and outreach through well-established printing and multimedia resource units.’ (para. 1.9.9). [**NB:** As we discuss in Parts III.C and IV.E, Auroville’s local, national and international outreach, with AV Media, newsletters, AVI Centres etc., are well-placed but need a systematic and strategic expansion to create targeted awareness of Auroville as a centre for multi-disciplinary advanced research and invite aligned individuals to increase population numbers.]
- viii. for education, two crèches (Transition and Deepanam), three high schools (Last School, Centre for Further Learning and After School), and four outreach schools (New Creation, Isaiambalam, Arul Vazhi and Ilaingarkal, serving 700 children) are identified. The Sri Aurobindo International Institute for Educational Research (‘SAIIER’) is identified as the nodal body for co-ordinating the schooling system. (paras. 1.9.11-12). [**NB:** We discuss developments in the educational sector since in Part III.E, particularly in relation to the loosely cast organizational setup.]
- ix. for health, the Auroville Health Centre is recognised as a mini health centre by the Tamil Nadu State Government, is equipped with basic medical facilities, with six sub-centres for serving the village population. No emergency or tertiary facilities are available, for which patients are referred to establishments in Pondicherry. In addition, it notes experiments with alternative healing methods and natural therapies. (paras. 1.9.13-14). [**NB:** Auroville has a strong bio-regional health support system. A review of healthcare systems is beyond the scope of our study. We offer brief remarks on internal capacity problems and the need for investment in tertiary healthcare and research in Part III.E.]
- x. for tourist infrastructure, the Visitor’s Centre, information centre and guest houses (capable of hosting 400 persons) are identified, with facilities for the youth and young researchers. (para. 1.9.15). [**NB:** There is currently no tourism management framework in place, which requires urgent attention. We discuss this in Part III.C.]

The Visitor's Centre complex, with its well-curated exhibition and inspired architecture, stands out as one of the early architectural achievements.]

- xi. for sport infrastructure, it identifies four play fields for various outdoor sports, such as tennis, football, volleyball and badminton, and a gymnasium and indoor sports facilities, with a beach developed at 'Repos' near Chinnamudaliarchavadi village. (para. 1.9.12). [**NB:** Basic sporting facilities have been built, with a supporting initiative by the Auroville Bio-Regional Sports Association. The robust infrastructure outlined by Mother for the ambitious plan of the hosting the Olympics, which serves as the high ideal, indicates that greater investment is required to develop world-class facilities. This seems unlikely without investments in the economy to generate sufficient surplus and growth in population numbers that can demand this infrastructure and render investment viable.]
- xii. for socio-cultural facilities, it notes that 'Auroville has become a hive for socio-cultural activities serving both Auroville residents and their neighbours.' This includes the Sri Aurobindo Auditorium at Bharat Nivas with a sitting capacity of 840 persons, where workshop, recitals of both traditional and modern dance, drama and music are regularly held. (para. 1.9.17). [**NB:** The importance of dedicated spaces for training and research (Mother's plan for the Cultural and International Zones) and a strong exchange with artistic institutions elsewhere, is important to develop a public culture devoted to tertiary training and research in the arts. There are some notable movements in this direction, but the two zones are yet to begin development at the scale and ambition of the vision. We discuss this in Part III.E.]
- xiii. the completion of the Matrimandir construction is noted, with emphasis now shifting to the development of the Matrimandir gardens. (para. 1.8.18-19). [**NB:** Our short discussion on Matrimandir above addresses the importance of this event. The dedicated work to develop the gardens, which we are informed requires further capital infusion, is equally significant.]
- xiv. for village development, the longest section in this part of the document, a range of development programmes are identified (Auroville Village Action Group, Health Centre, Pitchandikulam, Harvest, Palmyra), with their areas of activity. (para. 1.9.20-22). [**NB:** We discuss outreach and regional planning in Part III.C.]

On 'Administrative Setup':

- i. the structure of the AVF Act, 1988 is briefly outlined. (paras. 1.10.1-6). [**NB:** We consider the structure and interpretation of the AVF Act, 1988 in Part V.]
- ii. the internal governance structures are identified, with the Executive Council and Development Council in the lead, with the mandates of other groups (Economy Group, Entry Group, Funds and Asset Management Committee, Land and Estate Management, Project Co-ordination Group, Auroville Village Action Group, Farm

Group, Financial Services, Forest Group and Green Group) listed in Appendix II to the document. (para. 1.10.7). [NB: We consider the evolution and current state of internal governance practices in Part IV. The development of organizational schemes at this point seems to reflect an incipient movement responding to the needs of the time; however, as Mother outlined in the systems planning approach, cohesiveness amongst the bodies to prepare a planned socio-economic development approach, though references for its need are plenty, was a concern at this time, as today]

- iii. it notes, in relation to the working of these groups, that, there is ‘a considerable amount of autonomy in the preparation and implementation of projects which has been very helpful in motivating Aurovilians to participate in all developmental activities of the township. It has yet to achieve full co-ordination in order to meet the central objective of Auroville’s development as envisioned by the Mother. However, in order to plan and implement the Master Plan (Perspective: 2025) effectively, a separate outfit as part of the Foundation set-up would be necessary.’ This structure is proposed in Appendix V. (para. 1.10.8). [NB: This is an important point. The balance between organic and planned development to achieve co-ordination between independent, autonomously functioning groups is a core concern in the Masterplan, and remains so today. The proposed organizational structure in Appendix V not implemented after the notification of the Masterplan. We propose an alternate organizational template in Part IV to reflect developments since.]
- iv. five municipal services are identified, Auroville Water Service, Auroville Electrical Service, Auroville Telephone Service, Auroville Road Service and Auroville Eco-Service. (para. 1.10.9). [NB: The work of these services to establish basic municipal services point is noteworthy, with the need for a consolidated, empowered municipal body with clear executive powers going forward for city-building. We incorporate this in our proposed institutional template in Part IV.]
- v. for provisioning of necessities, Pour Tous is identified as the ‘centralised purchasing and distribution service’, which operates like a departmental store for daily necessities. There are no cash transactions, with accounts maintained on credit through maintenances granted to individuals for this purpose. [NB: We discuss the early economic setup, including the community provisioning made possible through Pour Tous, in Part III.F. The distributional question seems to predominate over growth concerns, which require structure recalibration. The ‘no-money-exchange’ ideal in particular requires coherent and clear specification, as between just forms of monetary exchange and non-monetary exchange, which have been conflated in the records on this point.]
- vi. for law and order, while there is no police station (in line with Mother’s wish), a police liaison services are available for emergencies. As Mother suggested, an

Auroville Guard, comprising young volunteers, to provide security services. (para. 1.10.10). [NB: this was an emergent area at the time. Going forward, the purpose, nature and manner of operation of security services in Auroville requires clearer definition, in terms of distribution of responsibilities, enforcement mechanisms and capacity development, as the between the Security Task Force, Auroville Guard, Working Committee, Auroville Council, Police Liaison and Governing Board, with powers delegated to the Secretary to the Foundation. We incorporate this in our proposed template in Part IV for an independent Auroville Security and Guard Service. We reflect on the important and delicate question of exit policies in Part IV.E]

On 'Funding of Township Activities':

- i. three sources of funding are identified: contributions from income-generating units, donations from private parties in India and abroad and Government of India Plan Grants. The average budget for 1991-2001 is Rs. 150 crores / year, with 100 crores (66%) through internal income-generation, 2.3 crores / year foreign donations, 1.9 crores / year through domestic donations and 0.8 crores / year through Plan Grants. (para. 1.11.3) [NB: As we discuss in Part III.F, the over-dependence on grants and donations is worrying; the Central Government's financial support for Auroville, approximately Rs. 103 crores in the last ten years, is notable, if insufficient for urban development in the earnest.]
- ii. The Financial Service, started in the seventies, attempts to do away with cash transactions, by keeping account of cash holdings and managing *intra* Auroville payments through these accounts. (para. 1.11.4). [NB: As we discuss in Part III.F, the ideal of a 'cashless economy' inspired by Mother's words, needs clear and coherent specification. As such, exchange through digitized holdings still implies a cash-based economy, only without circulation of physical currency.]
- iii. The Central Fund supports city services and maintenances of individual residents, with each income-generating unit providing in addition Rs. 1000 to each worker. Further, residents were asked to transfer moneys held in individual accounts to their Financial Services accounts, and contribute the interest generated therein to the collective. This resulted in a Rs. 4 crore corpus, with the interest going to the Central Fund. (paras. 1.11.5-6). [NB: We discuss the growth of the Central Fund, anchored by some key enterprises, particularly Maroma, and concerns with the modest maintenance amounts and limited surplus generation in Part III.F. Though we were unable to locate further information, the willingness of residents to pool individual deposits and forgo interest is a striking example of voluntary contributions for the collective good.]

On 'Land Ownership':

- i. As of August, 2001, Auroville owned 778 hectares out of a total of 1963 hectares in the plan area, or 39.6%. 25% of the plan area is located in the City Area and 75%

in the Green Belt. Of the remaining 1185 hectares left to be acquired: in the city, 5.3% and 17%, and in the Green Belt, 4.2% and 66%, are owned by the government and private parties, respectively. The balance of 156 hectares is covered under existing village settlements, water bodies and roads. (para. 1.12.1). [NB: The land acquisition concern remains as pressing then as now. We discuss land acquisition in Part III.B and the option for legal protection under a New Town Development Authority or otherwise in Part III.C]

- ii. A policy framework is noted to exist that to protect open spaces and environmental parameters to be adhered to for the development of land. (para. 1.12.3). [NB: We were unable to locate this policy framework in the archives. It is unclear if this document continues to be relevant. In general, as we discuss in Part IV.C, land and data management practices in Auroville are weak and require urgent attention through technology-leveraged solutions. A professionalization of the work of the Land Board, instituted after the Masterplan, is also pressing, given internal capacity constraints.]

Given this overview of the existing developments, the Masterplan outlines three imperatives for the development of Auroville:

- i. The lack of adequate housing, which has made it difficult to invite new residents. (para. 1.13.1). [NB: This continues to remain an impediment, perhaps the most important one, to city-building. It has led to a vicious cycle of slow growth and altered incentive structures for entry processes, which require strong capital infusion through long-term borrowing. We discuss this in Part III.D.]
- ii. Acquisition of remaining lands in the city area, needed to lay out cost-effective trunk infrastructure. (para. 1.13.1). [NB: This is again an impediment today. Both small population numbers and privately owned land in the city area push per-capita costs for infrastructure development. Developing this infrastructure (by removing overhead transformers, an exclusive broadband network, etc.) may disincentivize speculative buyers, as we discuss in Part III.B. Yet, absent an increase in numbers, and limited surplus for prior investment, this strategy is not cost-effective in the short-term. This is again a vicious cycle: low numbers and unplanned developments, leading to low surplus, disallowing infrastructure investment, leading to low numbers and so on.]
- iii. Preventing non-harmonious development in the Green Belt on the majority of lands not owned by Auroville. (para. 1.13.2). [NB: We discuss options to safeguard lands in the Green Belt in Part III.C]

In sum, as a historical document, the Masterplan lays down the state of progress till 2001. It recognizes the exemplary work done in regenerating the barren land, with notable, if slow, proto-urban developments in services, education and research, agriculture, housing, social and physical infrastructure and commerce. With this background, it positions itself at an inflection

point, to galvanize energies and systematically allow for urban development in what we may call the second stage of growth, shifting from the environmental imperative to a balanced urbanism. With this overview, Part II of the Masterplan accordingly provides a policy blueprint with development goals to be achieved across two phases: Phase 1 (2001-2010) and Phase 2 (2010-2025).

Building on our annotations above, we now review urban development planning and implementation since 2001 with the Masterplan, and Mother's early discussions, as historical and policy benchmarks. We divide this review into seven parts. Section (iv) starts with a survey of population growth as against Masterplan projection and work since; (v) considers how far the planning strategy of the Masterplan, in its proposed Development Plan for the years 2001-6 in Part II, was implemented, (vi) reviews major planning studies and proposals between 2001 and 2015, each aiming for a Detailed Development Plan; (vi) outlines governance concerns that emerged between this period; (vii) studies the period between 2015 and 2019, with various proposals for 'vision realignment' made in response to these governance concerns; (viii) considers the question of the development of the Crown and mobility networks; finally, (ix) reviews the trajectory between 2001 and 2023 to outline contemporary governance concerns, placing problems in historical context.

iv. Phased Population Growth and Demographics

Under the Masterplan, the Phase 1 target for population growth was 15,000 by the year 2010. This amounted to approximately 1,520 new residents per year, at an annual growth rate of 98.4%, with 10,000 persons in the working age group of 20-59 years. The target for Phase II was 50,000 residents by 2025. This amounts to approximately 2,333 new residents per year, at an annual growth rate of 15.5%.³⁶ In Phase I, the target for employment creation, largely in the secondary sector – including medium, small and cottage industries – was 6,000. This was to take place alongside the development of the tertiary sector (transport, services and consultancies), which was expected to employ an estimated 3,000 people, and the Green Belt, which was expected to employ 1,000 people.³⁷

As we discuss in Part IV.E with reference to the 'slow versus fast growth' debate, the third 'elephant in the room', Auroville's population growth rate of approximately 50 new residents per year is far below projected increases and an order of magnitude slower than what Mother had anticipated. Indeed, the need for a healthy rate of population increase has figured consistently in studies since the Masterplan, with various proposals to that end; yet none have translated into action, with a persistently slow decadal growth rate resulting in economic and development stagnation, along with sustainability and cultural concerns that dent Auroville's ambition to be representative of other collectives it was founded to lead.

The first movement after the Masterplan came in the 2003 'Masterplan Directions for Growth' Report – it proposed gross densities for the Residential, Industrial, Cultural and International

³⁶ Masterplan, 2001, paras. 2.1.1-3.

³⁷ Masterplan, 2001, Table 10, 43.

Zones at 358, 24, 16 and 15 persons per hectare, respectively, with an average of approximately 162 persons per hectare in the city area, and 30 persons per hectare.³⁸

Residential	%	Population (nos)	Sub total	No of units @ 2.5 people/ family unit	Res. area @ 40 sq mt/person as BUA	Sub Total	Social infrastructure @ 8 sqm/person as BUA
A - Individual Houses	20	750		300	30000		
B - Group Housing - low rise	40	1500		600	60000		
C - Apartment - high rise	40	1500	3750	600	60000	150000	30000
Cultural							
B - Group Housing - low rise		100	100	40	4000	4000	800
Industrial							
B - Group Housing - low rise	40	120		48	4800		
C - Apartment - high rise	60	180	300	72	7200	12000	2400
International							
C - Apartment - high rise		100	100	40	4000	4000	800
Habitat (City Centre)							
C - Apartment - high rise		350	350	140	14000	14000	2800
Crown (City Centre)							
C - Apartment - high rise		100	100	40	4000	4000	800
Green Belt							
		300	300	120	12000	12000	2400
Total		5000	5000	2000	20000	200000	40000

(Population distribution of housing in various zones. *Source*: Directions for Growth, 2003, 40-1)

These were in line with 1969 Anger's proposal, accepted by Mother, the 1968 'first masterplan' and within representative range of urban densities elsewhere, as we outlined in Part II.B. Coming on the back of the Masterplan, the report served as a useful and detailed template for growth, translating the principles of Mother's exchange with Anger into concrete targets. The Report however did not translate into policy action.

Subsequently, in 2010, the Advisory Committee of L'Avenir d'Auroville suggested a 'suitable induction policy' to ensure that in the 15-year period of the Masterplan, there is a growth of 3,500 new residents in the first five years (2011-2015) on a staggered basis. In the next cycle of five years, they suggested a projected growth of 5,000 new residents and the 'last cycle', from 2021-25, of 7,000 new residents. They concluded as follows:

In other words, the staggered demographic growth in each cycle of five years would imply that at the end of the 15 years, Auroville will have an approximate population of 18,000 residents. There should be a balance in the population between learning, serving and earning members.³⁹

³⁸ Directions for Growth, 2003, 40-1. A similar exercise was also conducted for the work force and their areas requirements, 42.

³⁹ L'Avenir Advisory Group, 2010, 8.

Again, no significant policy action resulted from the TDC or other Working Groups. Three years later, a similar, but more modest, population projection exercise was conducted in the Annual Development Plan of 2013 of the Town Development Council ('ADP-2013'), which forecasted a five-year growth trajectory as required by the Masterplan.⁴⁰ It proposed a 117% growth rate to reach a target of 'at least' 5,000 residents by 2018, 'to enable us to have a critical mass and economy of scale for services and infrastructure.'⁴¹ Alongside in 2014, the Integrated Development and Phasing Plan proposed the following population growth targets:

POPULATION		
Year	Total Population	Year when target population of 5000 will be reached
2013	2281	
Current Growth Rate of 4.5%		
2018	2794	2026
Decadal Growth Rate of 7.7%		
2018	3161	2025
Optimistic Growth Rate of 10%		
2018	3134	2024
Target Growth Rate of 24%		
2018	5000	

(Population projections, 2013-2018. Source: Integrated Development and Phasing Programme, 13)

Again, no significant policy action resulted, largely in part to continued 'development blockages' identified in the TDC Annual Development, 2014-15, which we discuss below. A few months later in 2014, the Land Suitability and Land Use Proposal by Auroville Design Consultants, commissioned by the TDC, similarly projected two rates of population growth, proposing a way for 50,000 residents to be accommodated given geospatial concerns and ground realities.⁴² The proposal worked out two scenarios. The first accommodated 18,000 residents in the Residential Zone, 'along with all amenities and services from the neighbourhood level to the sector and zonal levels. With 4% growth rate we would be about 5,000 persons in 15 years, and this population could be accommodated in sectors 1 & 2 without having to negotiate the parameters outlined'.⁴³ the second accommodated 35,000 residents, such that 'with (a) 10% growth rate we would be about 13,000 persons (including the present population of 2,500) in 15 years and this population could be accommodated in sectors 1 to 3 within the outlined parameters.'⁴⁴ As with the 2003 Directions for Growth Report, both scenarios include a proposed zonal distribution. The study estimates an average built-up area per person at 38 square meters, compared to the figure of 40 square metres proposed in the Masterplan and the higher 63 square metres in the Directions for Growth Report. As one of the new documents in this time that proposed concrete distribution figures, translating Mother's vision to practical, implementable terms, the proposal stands out amidst the raft of planning works at the time. Moreover, considering the debate on integrating Mother's vision with ground

⁴⁰ TDC, Annual Development Plan, 2013, 4-6.

⁴¹ TDC, Annual Development Plan, 2013, 24.

⁴² Land Suitability and Land Use Proposal, 2014.

⁴³ Land Suitability and Land Use Proposal, 2014, 24.

⁴⁴ Land Suitability and Land Use Proposal, 2014, 26.

realities, the proposal notes – with proposed ‘tweaks’ to the Masterplan across the four zones – that:

Both scenarios demonstrate that by tweaking the master plan 2025, the long-term environmental sustainability of the project does not contradict the potential growth in population or sabotage the habitat creation potential for 50,000 inhabitants, which is referred to as the ideal number indicated by the Mother.⁴⁵

Continuing in this chain of proposals, five years later, a 2019 study by Ayer et. al. on development priorities commissioned by the TDC similarly considered the issue of low population growth rates. It proposed a *yet* more modest increase in the range of 7%, reiterating concerns voiced in 2003, 2010, 2013 and the 2015 Auroville Retreat.⁴⁶ Importantly, besides the slow 3-4% decadal growth rate, Ayer et. al. record a further demographic concern that the growth rate for the age groups of 15-55 years is slower compared to that for 0-15 years:

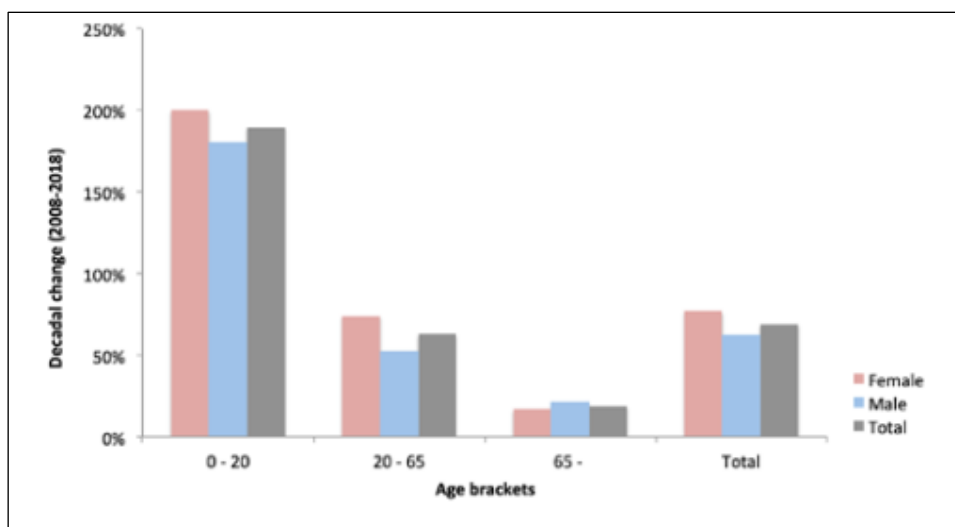

(Decadal population growth rate, bracketed by age groups. *Source:* Ayer et. al., 2019, 3)

The relatively low growth rate among the working-age population is worrying. It implies:

- i. A changed incentive structure for new residents, with resistance to increased densities and growth.
- ii. Insufficient outreach and insularity.
- iii. Financial barriers for young newcomers.
- iv. Greater spend on maintenance and services for an ageing population, with added weight to existing concerns with economic stagnation and the health of the Central Fund.

We address the economic and housing barriers in Parts III.D and F below. As Ayer et. al. note:

The data then clearly indicates without correction to facilitate youth and young adults to join, most of the revenue generated will be used to meet operational expenditure

⁴⁵ Land Suitability and Land Use Proposal, 2014, 26, *see also*, 26-33.

⁴⁶ Ayer et. al., 2019, 3.

with little surplus to invest in development. The resultant economic stagnation, if it spirals into a negative feedback loop would require interventions that (sic) compromise the autonomy of the project ... [As Revi noted in 2006] 'a lack of affordable housing and a possible deficit in available consumption expenditure from the basic "wage" paid to Aurovilians are possibly serious constraints to younger people joining Auroville and enabling the aspired growth in population to a critical mass.' 13 years later this observation is validated by the decadal growth rate of 2008-18 of the age group 20-24 years old. Moreover, the existing governance and administrative structure discourages startups and small businesses that could help with employment and housing.⁴⁷

Thus, despite concerns voiced repeatedly since the early 2000s, no policy framework or plans were put in place for incremental population growth. As we discuss in Part IV.E, Auroville's current growth is an order of magnitude slower than Anger's proposal accepted by Mother, the 1968 draft masterplan and the 2001 Perspective Masterplan. Comparing current numbers with Mother's early stewardship, we may refer to an early exchange dated 13th April, 1968 where Mother recounts a proposal by Anger:

Roger has come for five days, and he wants to make what he calls an 'Auroville neighbourhood', that is to say, instead of tackling the problem of ten or twenty thousand people at once, he wants to start with two or three thousand, on the level of infrastructure, but above all to see how it will work: the experiment of life in Auroville....⁴⁸

Similarly, in an interview, Anger noted:

When we reach two or three thousand people, a first section of the future city will have been built ... At a stage between five to ten thousand inhabitants we shall see what we call Auroville's first visage. Between ten and twenty-five thousand its second visage and the third from twenty-five to fifty thousand.⁴⁹

While her discussion does not consider this point further, it is striking that the minimum ranges to 'start with' – for a neighbourhood, not a city – are the current population numbers in Auroville. What is worrying is the lack of intensity and engagement in the community with the question of incremental population increases, a defining feature of the urban experiment that forms part of Auroville's founding ideal, despite several proposals to that end. Setbacks in implementation after the adoption of policy are natural, yet the absence of a collective intention to engage with policy proposals for growth indicates deeper and chronic governance concerns. They point either to a dilution of the vision, a resistance to manifest it or an inability to self-organize, with records indicating all three. Ayer et. al.'s concluding remark, which was not acted upon, rightly sums up the issue:

But 17 years after publication of the Asia-urbs report 2003, the population trends indicate that we may have about 5000 residents only by year 2030. This should be a

⁴⁷ Ayer et. al., 2019, 2-3.

⁴⁸ Guigan, 2018, Vol. 1, 279.

⁴⁹ Anger, '1', 1968.

convincing argument to undertake a complete review of Auroville’s governance and developmental policies, priorities and programs.⁵⁰

As we discuss in Part V, the democratic freedom of the community secured under the AVF Act, 1988 is tied to the imperative of Mother’s ideal to anchor a rich and dynamic spiritual urbanism. As seems to be the case here, a loosely organized democratic organization of the collective risks ‘fatal’ inefficiencies that require strategic, firm and urgent institutional correctives today:

... its method [that of a ‘more democratic democracy’] involves an immense waste of time and energy and a confused, swaying and uncertain action that ‘muddles out’ in the end some tolerable result. This method accords ill with the more stringent ideas of efficient government and administration that are now growing in force and necessity and it might be fatal to efficiency in anything so complicated as the management of the affairs of the world.⁵¹

We accordingly propose governance reforms in Part IV, with an emphasis on countering altered incentive structures to grow and the necessity of strategic growth plans on the part of all Working Groups prior to selection, against the accountability can be ensured by the proposed Unity Committee. The question, we may underscore, is not of population growth *qua* numbers alone, but rather *qua* the effective manifestation of Mother’s vision, which demands a certain scale, diversity, intensity and density in the collective. Slow population growth poses a major challenge for Auroville along many axes:

First, at its current scale, the benefits and challenges of urban agglomerations – in economic, research and cultural domains – are unavailable to Auroville.⁵² Managing the potency of clustering dynamics is a key part of the challenge of spiritual urbanism outlined in Part II, one that leads to the ideal of harmony in density . that was a defining feature of Auroville’s founding imagination. On one hand, Auroville’s representative character – to be a ‘model city’, a new urban archetype, discussed in Part II – is tied to this feature as it requires densities in the ranges identified above for agglomeration challenges to be effectively met. On the other, low numbers denies Auroville the benefits of scale – (i) economically, given capital formation concerns and cyclical stagnation of the commercial sector; (ii) infrastructure-wise, with high cost per capita for development of enabling trunk services; (iii) research-wise, with limited internal capacity across a range of disciplines and professional profiles and the inability to anchor at-scale and multi-disciplinary tertiary research facilities; (iv) land security-wise, given the inability to secure land protection from the Tamil Nadu Government due to density and land utilization concerns; (v) housing-wise, with insufficient capital generation to develop adequate newcomer housing stock; (vi) politically, in terms of entrenchment and repeat players within a small community; and (vii) culturally, denying the possibility of diversity and intense interchange between residents, a *sine qua non* for the ideal of human unity.

Second, at current density levels, Auroville is under-utilizing available land and the consequent sprawl is environmentally unsustainable. Taking the OECD’s working definition of a sprawl (defined either by population density of above 1,500 persons per sq. km., or built-up area),

⁵⁰ Ayer et. al., 2019, 4.

⁵¹ Sri Aurobindo, CWSA, 1997, Vol. 25, 473.

⁵² See, for example, Uqubay and Lin, 2020; Giuliano, 2019; Best, 2020; Royal Society, 2020.

Auroville's density of approximately 166 persons per sq. km. lies at 11% of the threshold.⁵³ By contrast, Pondicherry and Cuddalore, the two closest urban agglomerations, operate at 2900 and 704 persons per sq. km. as of 2011, and the Villupuram District, predominantly rural, has 481 persons per sq. km.⁵⁴ While the OECD threshold and comparisons are not strict, as Auroville must operate within the realities of its unique demographic mechanisms and productivity concerns, sustainability concerns at the level scale are apparent.

Third, the per-user costs of laying down public services (public transport, waste management, electricity, social infrastructure etc.) are consequently high. As the 2014 Land Suitability and Land Use Proposal notes, the 'population growth rate (<3%) did not allow for the structured development of public amenities to be cost effective.'⁵⁵ This creates a vicious cycle: low density and low population lead to higher costs, leading to lack of public infrastructure, which slows down growth. Absent a reasonable growth in population numbers over the next 5-10 years, infrastructure development necessary for Auroville's urban ideal is financially unviable from internal reserves, with work dependent on external grants and donations.

Fourth, green belts and buffer zones usually serve as urban containment policies.⁵⁶ With a quarter of the residents living outside the plan area, the buffer function of the Green Belt is not being served. As such, the Green Belt is not the city limit, a Rurban interface, as envisioned. As we suggested in Part III.D, Auroville may thus consider appropriate changes to its housing policy: first, by developing policy disincentives to leapfrogging development to reflect the social cost of sprawl, by shifting public service development closer to the city centre and a relative externalization of costs of waste management, electricity supply in areas outside; second, by refusing permissions for new residential settlements outside the plan area, unless mandated for regional development or other exceptional cases; and third, exchanging non-priority lands outside the plan area for priority lands within it, a long-standing and unmet task. We assess the question of exchange or sale of outlying lands in Section III.B.

Fifth, the low population growth rate reflects an inadequate outreach policy (beyond the bio-region), with limited partnerships with aligned institutions and research centers, an underdeveloped global footprint and the lack of an absorbing infrastructure (newcomer housing, strong research facilities, areas for high-skilled work, innovation incubators, etc.). It also indicates resistance to a shift from the first phase of environmental regeneration to the next, of sustainable urban development. To the extent this resistance has led to limited outreach – reflected in the altered incentives of Working Groups selected through popular participation – a shift of required, both in mindsets and institutional structures, to realign with the urban vision. We suggest some measures in Part IV.E.

Sixth, the lack of sufficient low-cost, ready-to-occupy newcomer housing (and research-linked accommodation) is an impediment to quality growth, creating financial entry barriers for a younger population critical to sustain a demographic profile consistent with Auroville's research aspirations. This creates a vicious cycle: lack of housing leads to slow growth, which

⁵³ OECD, 2018, 3.

⁵⁴ These are figures as per the 2011 Indian National Census.

⁵⁵ Land Suitability and Land Use Proposal, 2014, 10.

⁵⁶ See, discussion in Auroville's context in Evangelista et. al., 2018.

in turn leads to limited capital surplus and research and social infrastructure, which results in lack of investment in housing, and so on. We consider the housing question in Section III.D, and suggest deductions under the 2017 Code of Conduct for investments by Auroville commercial and service units in incremental housing.

In sum, as we discuss further in Part IV.E, enhancing population numbers is key for Auroville. It requires concerted and strategic action to reach critical mass, rather than a wait-and-watch approach that has not produced the desired results since 2001.

v. *Review of Planning Strategies*

In line with the UDPFI Guidelines 1996, the Masterplan envisaged a hierarchy of plans for the systematic development of the city. This included a five-year Detailed Development Plan ('DDP'), an annual plan, a layout plan and a plan of projects. It is important to underscore that the Masterplan is a policy document and not a detailed development plan that can guide the execution of works. As such, absent the subsequent hierarchy of plans, the Masterplan is an insufficiently detailed document to anchor city-building. We provide below the proposed planning strategy.

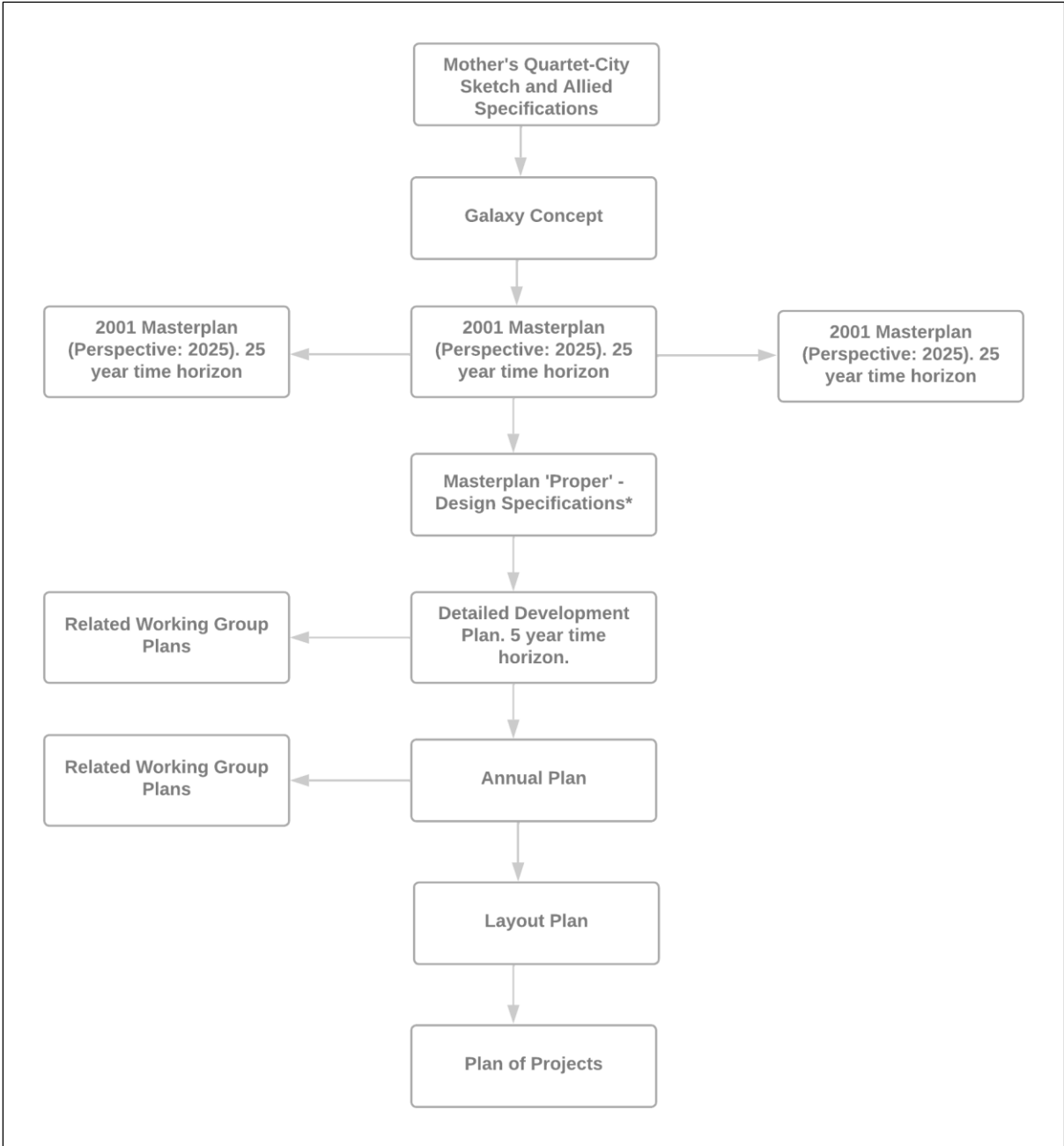

(Planning hierarchy in the URDPFI Guidelines, adopted in the 2001 Masterplan)

This hierarchy of plans was reconsidered in the amended URDPFI Guidelines of 2014, which note:

The Core Area Planning comprises of a set of 4 interdependent plans: (i) a long-term Perspective Plan with a vision and policy orientation, (ii) a sustainability based long term Regional Plan (and District Plan) with optimization of regional resources for development, (iii) a comprehensive long term settlement plan as Development Plan for urban and peri urban areas (iv) A short term rolling Local Area Plan within the framework of Development Plan. The Specific and Investment Planning comprises a set of three plans, (i) A rolling Special Purpose Plan for special areas within the framework of Development Plan, (ii) Annual Plans to translate the physical and fiscal resource requirement of Development/ Local Area Plan, and (iii) Project/Research to focus on items of execution. The URDPFI Guidelines, 2014 are intended to be comprehensive for promoting balanced and orderly regional and urban planning and development. These Guidelines inter-alia provide the framework, necessary techniques, norms and standards, options for resource mobilization including land assembly approaches, and development promotion regulations. Since conditions vary from place to place and even within a settlement, these guidelines may not be uniformly applicable to all situations and places and would need to be modified and adopted depending on local conditions, felt needs and technological innovations so that the Planning process may serve as an efficient and dynamic instrument. The URDPFI Guidelines are expected to provide an integrated framework for urban and regional plan formulation and implementation.⁵⁷

With the exception of sporadic annual plans in some Working Groups, it seems that none of the hierarchy of plans proposed to be developed in the Masterplan or in the amended 2014 Guidelines materialized, despite a raft of expert proposals and over 300 surveys and studies since. We review planning efforts between 2001-2022 in this direction in the following sections, yet it bears noting that this is all the more worrying as the Masterplan itself provided a five-year Development Plan – not a DDP proper, but a useful policy document nonetheless – for the years 2001-2006 that could have served as an immediate template. In this, the Masterplan proposed an investment of Rs. 350 crores on infrastructure development. Briefly, it suggested:

- i. The largest share of funds, approximately 31%, allocated to the development of housing in Residential Zone (Rs. 107Cr.), to address the housing crisis that hampers population growth and persists till date. In this, it proposes the construction of 92 apartments, progressing the Residential Line of Force with 2 apartments, new residential units capable of accommodating 4000 new residents with accompanying social infrastructure (over 3000 sq. meters), development of the Crown (over 3000 sq. meters). With the exception of some housing units, these proposals did not materialize.⁵⁸
- ii. The development of the Industrial Zone with an allocation of Rs. 35.90 crores, with the development of the Town Hall (accomplished subsequently), and incense, food

⁵⁷ URDPFI Guidelines, 2014, iv-vi.

⁵⁸ Masterplan, 2001, 76.

processing and yoga units. In this, it proposes the development of industrial spaces (over 15,000 sq. m), 500 residential units (over 15,000 sq. m), workers' welfare infrastructure (over 2,000 sq. m), off-site infrastructure (over 8 hectares) and development of the Crown (over 4,000 sq. m).⁵⁹ Again, most of these proposals were not translated into annual plans, as anticipated under the UDPFI Guidelines.

- iii. The development of the International Zone with an allocation of Rs. 33.76 crores, including the construction of the Bharat Nivas, Tibetan and Unity Pavillions, extensions of Savitri Bhavan and the Visitors Centre, and a guest house (most of which were completed, as ongoing projects at the time). It further proposes the construction of the American, Russian and African Pavilions and the Tamil Cultural Centre, the development of the Centre for International Research on Human Unity (over 6,000 sq. m), development of the Crown (over 12,000 sq. m) with 200 residential units and guest houses and off-site infrastructure development (over 7 hectares).⁶⁰ Again, aside from some limited movement on the proposed pavilions, none of these proposals were translated into annual plans.
- iv. The development of the Cultural Zone with an allocation of Rs. 37.30 crores, with the development a high school, sports complex, arts workshop, and glass training centre (as ongoing projects, subsequently developed). In this, it further proposes a large cultural and education complex (over 20,000 sq. m), development of the Crown (with 300 units over 9,000 sq. m), residential and social infrastructure (over 6,000 sq. m) and off-site infrastructure development (10 hectares).⁶¹ While progress was made on the educational front (as we consider in Part III.E), it does not reflect the range of proposals outlined here, which were again not translated into a development plan for the Zone.
- v. The development of the Green Belt with an allocation Rs. 62.62 crores, with ongoing land regeneration works and organic farming (where substantial progress was recorded especially in the former, as we consider in Part II.7) In this, it further proposes applied research projects in urban sustainable development, village development and outreach, development of service nodes and city level recreational facilities, a cremation and burial site, building of cycle tracks and pathways and importantly, the acquisition of 400 hectares to secure the material base of the city.⁶² While substantial outreach activities were developed and conducted in that period and since, systematic movement on the other proposals was largely missing, with the 2013 Green Belt Land Use Plan and other regional planning frameworks (which we consider in Parts III.C and G) yet to be adopted formally.

⁵⁹ Masterplan, 2001, 77.

⁶⁰ Masterplan, 2001, 78.

⁶¹ Masterplan, 2001, 79.

⁶² Masterplan, 2001, 80.

- vi. Prioritization of land acquisition, with an estimated cost of 8 lakh per hectare from 2001 to 2006 and 9 lakh per hectare from 2007 to 2010, for securing the material base of the city (now significantly higher given speculation) remains a continuing concern, with resource mobilization at much lower levels. We consider this in Part III.B.

None of the Masterplan's policy proposals seem to have been incorporated in the subsequent years in formally approved development plans for implementation. Equally, the organizational structure suggested in Appendix 5 (which we consider in Part IV) for the implementation of the Development Plan for 2001-06 was not adopted. This can be traced to two key factors:

- i. The general perception of the Masterplan as a tool for securing lands and not for city-planning, reflected in the early debates in the Residents' Assembly in 1999, as also in the General Meeting of August 2020.
- ii. An unsystematic approach, or, in some cases, active resistance, to the development of urban infrastructure in the city area, accompanied by a preference, partially misplaced in our view, for 'organic' as opposed to 'planned' development, a false dichotomy that has resulted in hap-hazard development; a practical manifestation of 'vital subjectivism'.

In the following sections, we trace efforts at planning after 2001 for the development of social and physical infrastructure, including attempts to formulate zone-wise DDPs, and explore further reasons for the lack of movement. Between 2001-2022, as per our rough count, there have been approximately 50 major planning documents, including draft Detailed Development Plans for some of the primary zones, City Centre development, mobility, sustainable development, bioregional development, tourist management, Green Belt development, plans for the housing and commercial sectors and more than 300 'minor' reports or studies in various sectors. As we discuss below, most have not translated into action, with a repetitive cycling of issues demonstrated in the record going back to 2001. There is a striking contrast between report generation and on-ground development. For ease of study, we may divide these pre and post the publication of the Masterplan in the Gazzette in 2010.

Before 2010, the focus, albeit limited, was on the construction of essential physical infrastructure, with the building of the Town Hall, Auroville Centre for Urban Research, SAIIER, Solar Kitchen, schooling infrastructure post the Pande Visiting Committee Report etc., largely under the Asia Urbs Programme and Government Plan Grants, alongside some independent housing and commercial units. The records do not however indicate any work towards a DDP. Formally, there were several studies commissioned by the Planning and Development Group and Aurofuture, the entities that preceded the L'Avenir till 2007. These included the 2001 Schmidt and Billinger mobility study, the 2005 Auroville's Future detailing, the 2003 Directions for Growth Report and Kundoo's 2007 City Centre Proposal, amongst several other planning documents that emerged from Aurofuture, run then under Anger's

guidance.⁶³ The level of community engagement with Auroville's formal planning groups was minor. This led to some work outside the formal bracket, particularly with the Dreamcatching initiative which began in 2005, to facilitate greater community participation.

After 2010, the end of the imagined first phase of the Masterplan, there were relatively more focused attempts to develop DDP. It seems that the publication of the Masterplan in the Gazette in 2010 spurred this work, though this shift does not seem to reflect in the community. There appears from this time onwards a distinct divide between the formal planning efforts led by the TDC and commissioned experts, on one hand, and the community, on the other. There is, as we discuss in Part IV.A, a growing need for professionalization of Working Groups, with technical expertise in urban planning, architecture, engineering and mobility, yet a resistance in the community to this necessary rationalizing movement borne of a distrust of technocratic capture. By 2008, Aurofuture and the Development Group had given way to APDC, formed as a product of Auroville's participation in the European Commission's Asia Urbs Programme. It was subsequently replaced by a new 10-member planning group - L'Avenir D'Auroville, or the Auroville Town Development Council ('TDC'), incorporating the name suggested by Mother. The TDC Advisory Group ('TAG') was constituted at the time, with its members also making several proposals, though largely without effect. The period between 2010-2015 saw a flurry of planning activity: the 2009-2013 Integrated Sustainability Programme, 2010 recommendations for action by Mr. Dattatri, 2011-2013 proposals by the TAG, 2011 Grant Belt Development Plan and 2013 Green Belt Land Use Plan, 2013 Water Sourcing Study, 2013 TDC Development Plan for the years 2014-18, 2014 Integrated Development and Phasing Programme, 2014 Land Suitability and Land Use Proposal, 2014 Feduchi Detailed Development Plan for Residential Zone Sectors 1 and 2, amongst many others. None, other than Feduchi, led to a DDP, though that too was not finalized. Alongside, in this period, beginning from 2009, planning conversations on marking the rights of way for the Crowns and Radials began, with a series of proposals and 'all-party' decisions on the placement and width of the common areas and details of the infrastructure corridor, that continued till 2022 without clear resolution.

The lack of community engagement or agreement seems to have come to a head in 2015. With growing discontent, a distinct shift can be seen in planning efforts from 2015 onwards, to 'realign' the community to the vision. This included the 2014 Vision Task Force and 2015 Auroville Retreat, Mr. Doshi's 2015 proposal to prepare a DDP, the 2015 'Selection Committee' to restructure the TDC, the 2015-2017 process amongst the Residents' Assembly, Working Committee, Auroville Council, TDC and various sub-groups to develop the 2017 TDC Terms of Reference, the 2018 sub-group to study internal disagreements in the TDC after the restructure, the 2018 International Zone Strategic Plan, 2018 Memoranda of Understanding between the TDC and two local panchayats, the 2019 Development Priorities Report, commissioned by the TDC, and many others. Despite these studies, either ones formally

⁶³ Anger returned to Auroville in 1987, with Zonal Plans for the International Zone and Cultural Zone prepared around 1995 alongside work on the Crown. We did not study Anger's personal archives. As such, a compiled, catalogue and digitized archive of all planning documents from 1968 would be helpful both as a historical resource for research and to inform planning work today.

commissioned or informally conducted, expert-led or community-driven, no draft DDP either the city or zone-wise was prepared.

After COVID-19, the appointment of the new Governing Board in 2021 brought these matters to a head, with an explicit recognition of the failings of the planning process till that time in the 57th and 58th Minutes of Meeting of the Board. The focus, at first, was on developing the Crown – with the Dreamweaving Forum, followed by the Mobility Forum and Crownway Study, in 2022. The first, with great promise and positive reception by the Governing Board, proceeded to bring together hitherto parallel tracks: the Governing Board, TDC, internal and external experts and the community at large. The services of Mr. Doshi’s firm, Vastushilpa, was reengaged after the rejection of his proposal in 2014. For reasons that remain unclear, the effort did not come to fruition. With conflict ensuing on the clearing of the Crown in December of that year, we are informed that a Memorandum of Understanding was signed in late 2022 / early 2023 with the CPWD, though the document is not part of the public record. Along the way, more than 300 ‘minor’ studies were conducted, many that seem to be lost in the mass of planning documents – these include important works in mobility, water resource management, energy systems, housing surveys, GIS mapping etc., yet are themselves not attempts at a DDP.

In parallel to this raft of planning work, individual residents, units and zonal groups across sectors have continued project development independently, with the final result being that on-ground work has proceeded unsystematically outside any policy framework. What emerged as a worrying disengagement between the formal planning workstream and the community in the early 2000s, beginning with low participation in the Residents’ Assembly discussion of the Masterplan in 1999, seems to have become a settled fact in Auroville’s governance. Given this state of affairs, examining the details of each of these studies is important and necessary. That, however, is a task in itself. Our attempt here is more limited: we neither summarize developments nor weigh in substantively on urban planning issues – most of which lie beyond our domain expertise. Rather, we narrate the complicated movements to plan and build the urban infrastructure between 2001 and 2022 with a view to draw out salient points in the governance trajectory that may inform future choices. Taking stock of the past is, in our view, helpful to chart pathways forward.

vi. Planning Movements, 2001-2010

We briefly review here the Directions for Growth Report of 2003 in section (a), followed by early mobility and city centre development proposals in section (b) and the 2005-2009 Dreamcatching forum in section (c). Section (d) reflects on the planning questions and debates that emerged at this time, an ineffective resolution of which has hampered the implementation of planning studies in this period.

a. Directions for Growth, 2003

The early ‘Directions for Growth’ report of 2003 was the first formal planning study after 2001 prepared under the Asia Urbs Programme. It provided a blueprint for development for the five-year period 2003-08. The stated objective was to:

... chart out a road map for the future, indicating directions for its growth in the coming five years, which can lay a strong foundation for realizing the city in a systematic, professional and humane way over the coming two decades.⁶⁴

This early recognition of the need for expertise and professionalism in urban planning is, as we note in Part IV, an important shift towards rationalization that been resisted in policy movements since. This is a key movement for the manifestation of the ‘city’, which will require a reworking of the 2022 Selection Guidelines and a clear distinction between legislative and executive domains. The report suggested the following areas for development:

- i. Promotion of economic self-sufficiency so that limited resources currently channelized towards fund-raising may be diverted to (a) acquisition of remaining lands and (b) the construction of ‘actual buildings and infrastructure.’⁶⁵ The concern with limited capitalization of the commercial sector, which we discuss in Part III.F, has a bearing on urban development: absent structural changes to the commercial and industrial profile, the mid to long-term sustainability of the urban ideal is suspect. The reference to ‘actual buildings and infrastructure’ is an obvious yet important reminder today, given the raft of planning work since that has not resulted in on-ground construction – for the integral realization of Auroville, the vital and physical worlds need to be manifested, which no amount of metaphysical speculation can address.
- ii. Focus on developing Auroville’s physical urban form starting with the city centre, as ‘there is no identifiable physical framework on the ground to facilitate the development of the city in its proposed urban form. The first step therefore is to establish a firm physical identity within which the new developments can take place.’⁶⁶ With the relative non-priority of the urban form of the Galaxy till that time, this remark points to the need for a phase shift from the environmental imperative to a sustainable urbanism. At base, as work since has emphasized, a clarification of the form of the Galaxy in Zonal Development Plans is required to signal future development – unsystematic growth is unlikely to ‘spontaneously’ lead to Auroville’s ideal, and indeed, will inevitably lead to conflict as ground realities move further away from the form of the Galaxy. This seems to be the case, as for example, in relation to Feduchi’s 2014 plan. We discuss this in Part IV.D.
- iii. The need for clear strategies for economic self-sufficiency, including
 - a. revenue mobilization through strengthening existing and incentivizing the development of new commercial units. As we discuss in Part III.F, this concern, bolstered by Thomas and Thomas’ work, is pressing today. There appears to be an insufficient understanding of the structural concerns in the commercial sector.

⁶⁴ Directions for Growth, 2003, 1.

⁶⁵ Directions for Growth, 2003, 19.

⁶⁶ Directions for Growth, 2003, 38.

- b. creation of ‘Goodwill Zones’ in lands yet to be acquired along the Green Belt to build ‘a strong agro-sustainable economy’.⁶⁷ Food security concerns, both in relation to lands owned by Auroville and collaboration with privately owned lands, continue today. The 2011 Agricultural Growth Plan was an important shift in this direction, yet concerns persist. We discuss this in Part III.G.
- c. promotion of quality population growth by setting up world-class infrastructure for research, higher-learning and skill development that would draw Auroville youth into leading socio-economic affairs of the community and attract quality populations from India and abroad. As we discussed above, the question of population numbers, both in terms of quantity – to activate economies of scale and clustering benefits – and quality – to develop a research infrastructure – is a major policy gap. Work on this front has been limited, with what appear to be altered incentives to growth post 2000 and an unhealthy insularity.
- d. The acceleration of physical infrastructure projects such as the Centre for Research on Human Unity, collective housing (and a sense of community) in the Residential Zone, City Centre development and roadways for mobility. As we discuss presently, formal planning work for each of these tasks have proceeded apace, but community uptake and implementation capacity are chronic concerns.

b. Early Mobility, Crown and City Centre Proposals

With the relatively uncoordinated and dispersed development within Auroville till that point, and a fast emerging urban and suburban neighbourhood in the bio-region, an early push was made to consciously plan future efforts. This manifested in a concentration of work on mobility planning, given increased vehicular usage, and City Centre and Crown Development, given the need for shared common spaces to shape a closely-knit and elevating urban social fabric. No discernible implementation resulted, yet the insights offered at the time are important both to trace the historical trajectory of urban governance and assess planning needs today.

1. Mobility Plans

Two early mobility plans came in 2001 and 2005, prepared by Auroville Associated Architects in collaboration with Helmut Schmidt and a German traffic consultant and transportation planner – Schmidt and Billinger.⁶⁸ These were detailed out by Auroville’s Future and approved

⁶⁷ Directions for Growth, 2003, 19-20. The Goodwill Zone proposal comes a 2003 paper by Chandresh Patel. This is key, as we discuss in Part III.G (‘the concept propounded for Goodwill Zones ... is eminently suitable not only for building enduring links with the surrounding communities and securing the lands in the Green Belt from inconsistent use, but also for building up a strong agro-sustainable economy for Auroville, as well as the people from the villages within the Auroville township area.’)

⁶⁸ Billinger and Schmidt, 2001; Auroville’s Future, 2005.

by Anger in 2005.⁶⁹ We address this work in section (ix) in relation recent works on the Crown, but briefly, they lay down the principle of mobility planning in Auroville:

Auroville, to be true to The Mother's vision, will provide alternative forms of mobility to suit the needs for peaceful conditions throughout the city area. Today's type of environmentally polluting, hazardous, and high-speed motorized transport will no longer have its predominant, overbearing position – the individual will regain his own spatial dignity.

...

An environment free of noise and other traffic-hazards befits a calm and tranquil area. Children and the elderly can move freely with minimal danger. Cyclists will be allowed where they do not disturb. Delivery and removal will be municipal, eco-friendly vehicles, their access restricted to certain times of the day. All motor-vehicles will have to adjust their speed and give priority to the pedestrians. As no privately owned vehicles will be encouraged, Aurovillian's who do own a vehicle (which may be used only outside the city), shall park their vehicle at one of the Primary Nodes garaging facilities.

...

Providing an efficient and attractive public transport system - shuttle - will be a fundamental precondition to complement the needs of a mobility friendly city. Since all modes of transportation will be provided and maintained by the municipality there will be no need for private vehicular ownership.⁷⁰

The 2001 and 2005 documents emphasize five key aspects:

- i. Prioritise pedestrians and emphasize the creation of walkways and pathways for active transport (cycles, bullock carts), with regulated traffic on a hierarchy of roads.
- ii. The volume of permissible traffic is proposed to decrease as one moves inward from the city limit (i.e., the Green Belt) to the Matrimandir.
- iii. Primary and secondary service nodes, proposed in Anger's early detailing as transition links for Auroville's connect with external movement, are suggested to serve both as transport-changing points for visitors and villagers, and as cultural hubs with commercial and recreational activities.
- iv. A non-polluting shuttle bus is proposed to operate along the Crown and the radials to ferry visitors from the service nodes to the inner-city area.
- v. In order to facilitate behavioral change and encourage the use of active/public transport and walking, the studies propose pilot initiatives on small stretches,

⁶⁹ Auroville's Future, 2005; alongside, work was conducted on costing of roads. Mabilat, 2001. *See also*, for historical context, 'Roads in Auroville', 1984-1995.

⁷⁰ Auroville's Future, 2005, 4, 5.

accompanied by awareness campaigns and redesigning streets to make them inviting and walkable.

The emphasis on common spaces, to develop a cohesive public space, and conscious movement in those spaces are interrelated, with, crucially, Auroville remaining free of all privately owned vehicular traffic:

The Auroville Master Plan envisages the street as a common space for all. Wherever vehicular movement is permissible within Auroville itself it will be restricted to approximately 15 km/h, a speed indicated by the Mother. • All fast-moving vehicular traffic will remain outside the city limits. • All of Auroville's traffic systems will be provided and managed by the municipality. • Auroville will provide the most energy efficient, non-polluting, user-friendly modes of mass, and individual, public conveyance systems. • There will be no other private or independent traffic systems inside the town.

It is envisaged that to provide Auroville's city area with a non-polluting, user-friendly mass transport, alongside the pedestrians and cyclists, a system of shuttle-transport will be required for all Aurovilians, guests and visitors. This service will operate both on the Crown and the Radials. It will start at a Service Node and pick up anybody arriving there in conventional motorised vehicles.⁷¹

The following three extracts speak to the vision. The first anticipates an urban design where residents can easily walk from one end of the city to the other, with a regular, electric shuttle service running every ten minutes to assist movement. The second anticipated a shuttle or tram service across the city, moving from fossil-fuel to electric modes of transport, eminently possible today. The third specifies the widths of the Crown, as between the right of way (18 metres), carriageway (8 metres), pedestrian (3 metres) and cycle paths (2.5 metres). Taken together, they offered a detailed and practical mobility plan to stem to increasing flow of unregular vehicular traffic at the time, with its socially alienating and physically congested results, and acculture future movement patterns to non-polluting and warm, interactive spaces for residents, including children, moving from zone to zone.

⁷¹ Auroville's Future, 2005, 6.

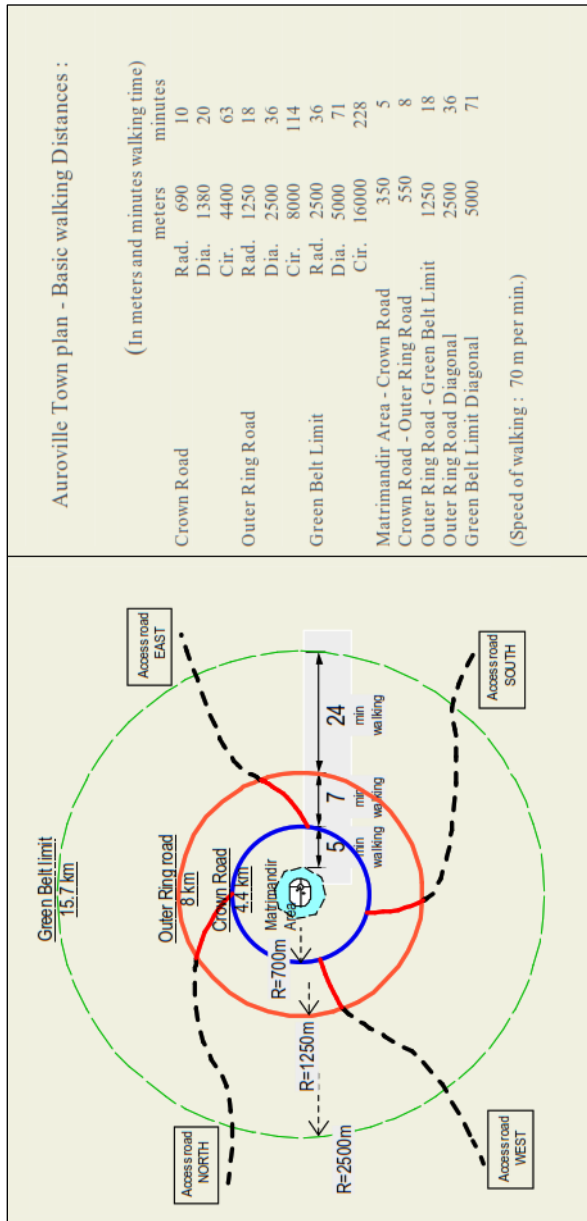

If the shuttle bus starts here and maintains a maximum speed of 15 km/h (average speed 10 km/h including stops), it will be back within 30 minutes time after circling around the Crown.

To attain a frequency of less than 10 minutes, 4 buses will be necessary.

Insistence on non-polluting shuttle transport is the basic concept of Auroville as an ecological and sustainable project. But just by giving priority to buses instead of individual motorised transport, an enormous improvement in air quality is achieved; and even more so when the latest standards, e.g. particle filtration, are complied to. Technically, the best developed contribution to pollution-free motors are natural gas (CNG) motors. Even electrically driven buses are inferior to gas driven buses, for though they do not emit harmful exhausts locally, they do add to air contamination on a wider scale.

When fossil fuel is used, the problem of CO₂ is inevitable. In case of natural gas (CNG), all other emissions (CO, NOX, SO₂, Volatile Organic Compounds etc.) including smells that are substantially redCNG driven Buses reduce pollution in city areas significantly. They are more energy efficient. New Delhi is a good example.

If a tram or an alternative is envisaged as public transport, it is important that it moves within a speed limit of 15 km/h. Such a train can easily operate in the middle of a pedestrian street, amongst other "permitted" vehicles.

One could imagine a tram, cautiously moving with 10 km/h, allowing embarking and disembarking without requiring a stop, except on request by people with reduced abilities.

(Top, walking distances across the city. Bottom, transport options. Source: Auroville's Future, 2005, 7, 11)

			Dimensions						description	
			1. Width Carriageway (m)	2. Width Right-of-Way (m)	3. Radius to road centre (m)	4. Building Line Setback (m)		5. Width Pedestrian Path (m)	Width Cycle Path (m)	
						on one side of road	on both sides of road	on both sides of road	on both sides of road	
Category	Zone / No:									
CROWN Road			8.00	18.00	690.00		2.50	3.00	2.50	
RADIAL Road	Cultural	1	6.00	11.50		2.00		3.00	2.50	Schools + future access to Pondy Univ.
		2	4.00	9.50			2.00	3.00	2.50	Sports facilities, stadia
	Residential	3	4.00	9.50		2.00		3.00	2.50	Gaia
		4	6.00	11.50			2.00	3.00	2.50	Vikas
		5	6.00	11.50			2.00	3.00	2.50	Solar Kitchen
		6	8.00	19.00			2.00	3.00	2.50	Aurodam
		7	10.00	20.50			2.00	3.00	2.50	Centre Field (main entry)
	International	8	4.00	9.50			2.00	3.00	2.50	Visitor's Centre
		9	6.00	11.50		2.00		3.00	2.50	CIRHU
	Industrial	10	8.00	19.00			2.00	3.00	2.50	Pondy Farm
		11	8.00	19.00			2.00	3.00	2.50	Verite
		12	8.00	19.00			2.00	3.00	2.50	Sve Dam
GREEN Corridor				> 30			< 1.5	< 1.5	Vehicle-free paths (minimum)	
OUTER RING road			10.00	21.00	1250.00		2.00	2.50		
Service Road			3.50	6.00						
Access Road	Residential/SOUTH	1	10.00	30.00						
	International/WEST	2	10.00	30.00						
	Industrial /NORTH	3	10.00	30.00						
	Cultural /EAST	4	10.00	30.00						

(Summary of traffic planning guidelines. *Source:* Auroville's Future, 2005, 10)

Some attention was also paid to the Service Nodes, meant to consciously regulate entry into the city. As we discuss below, with the rapid development of highways and road networks around Auroville since 2005, this is a key design future yet to manifest:

These nodal points will serve as transport mode exchange areas, offering parking facilities for visitor buses, cars and two-wheelers. There are two types of Service Nodes: Primary Service Node: located at the outer edge of the Green Belt (Town Boundary), will help to regulate entry into the town – visitors and tourists, goods and vehicles. Guests and visitors arriving at Auroville by bus, car or two-wheelers will be received at one or more Primary Nodal points. Visitors will move to Auroville's non-polluting municipal transport (shuttle) to visit various places. Construction and other bulky materials will be downloaded and / or transferred to Aurovillian transportation services (probably the only exception being ready-mix concrete Lorries that will be permitted to enter throughout the construction phase of Auroville). Secondary Service Node: located on the inner edge of the Green Belt and the outer limit of the Town – Outer Ring Road. The Aurovillian coming from or going to the outside will park here any conventional vehicle (car or motorbike), using Auroville's Municipal, internal transportation system. A Godown and / or vehicle transfer facility will provide external to internal delivery service for goods supply and refuse disposal. Various Aurovillian services, Government offices will offer public facilities such as information desks, shops, artisan workshops, exhibition areas, and the like.⁷²

⁷² Auroville's Future, 2005, 9.

Alongside, in 2003, Schmidt wrote a short and insightful essay on public spaces and development of the Auroville Crown to promote ‘traffic calming’.⁷³ Taking the ‘street’ as the long-term unit of city planning, Schmidt counselled against a motorization of Auroville to design a ‘car-free’ city that may allow for the easy and serendipitous movement of residents in a climate conducive to social interaction:

The ‘drive-in city’ maintained its appeal right into the seventies of the twentieth century, resulting in a very serious threat to the human quality of city life. The still continuing invasion of the automobile and its byproducts, through the preference given by planners to the security, speed and ease of motorised transport has turned many lovely cityscapes into inhuman automobile-slums, congested with vehicles and polluted by poisonous fumes. Here the predominant feeling for the individual on foot is tension and danger, not at all a climate for social interaction – one cannot let down one’s guard. Public spaces are degraded to traffic junctions, and congestion, accident rates and pollution are still escalating to more and more intolerable levels. Any non-motorised traffic participants such as pedestrians and cyclists are usually given second priority. The result is the loss of vivid street life and the disappearance of functioning public spaces in our cities - not to mention the negative effect on the health of human beings and the planet as a whole.

...

The cities of old were based on pedestrian movement, their size adjusted to a maximum extent of 3 to 6 km. Auroville’s diameter is 2.5 km (the city circle within the Outer Ring Road). This means that it can be crossed by foot within 35 minutes (70m walking speed per minute).

Why not declare the whole city area within the Outer Ring Road an area of pedestrian priority, with limited access for individual motorized transport? Car and motorbike drivers could reach their destinations via the Outer Ring Road where they can move freely and from which they can access the different zones of Auroville. But they would have to return to the Ring Road to reach other targets, since they should be allowed to enter the Crown only for emergencies. One should not be able to drive around or across inside the City Circle. As we can see on Connaught Circus in New Delhi “Inner Rings” attract traffic with magnetic force, because the shortest trip to cross the city will pass through them. This is definitely not desirable for Auroville’s Crown. Instead we should be aiming for a centrifugal effect as far as motorized traffic is concerned, stepping down its disturbance from the periphery to the centre – an area which contains the “Soul of Auroville”, the Matrimandir, and was named “Peace” by the Mother.⁷⁴

Accordingly, he concluded:

The ideologies on which most cities and housing areas have been planned right up to the 1980s gave priority to automobile-based mobility. But private motorized traffic has turned out to be the key obstacle in developing a sustainable and livable city. As long as cars and motorbikes dominate, cities lose the benefit of streets as public space

⁷³ Schmidt, 2003, 4.

⁷⁴ Schmidt, 2003, 1, 3-4.

which are a vital part of its social landscape. “Car-free” is rapidly becoming part of the vocabulary of forward-looking city-planners.

In the planning of Auroville it ought to be our major aim to reduce vehicle counts on the Crown, which should be designed primarily for pedestrians, cyclists and Public Transport. This will help to maintain a high quality of life in our city-centre and peace around Matrimandir.⁷⁵

Between 2006-2010, a series of mobility planning efforts ensued. In April, 2006, the Planning Group proceeded with the objective to ‘assist in developing planning guidelines for a phased development of the Galaxy concept, taking into consideration the existing development, social and environmental realities.’⁷⁶ The concern voiced that the time – ‘to prevent random and chaotic development’ – is particularly pertinent, and has intensified over the years across all Zones as we will see below.⁷⁷ Unlike subsequent efforts over the years, this report addressed not only internal mobility issues, but also regional ones. Anticipating projected developments of railway and water ways, along with an airport extension and link roads, as also suburban and industrial development from the south of Auroville along the East Coast Road, the report suggested the ‘representation from Auroville in the inter-state and local bodies’, ‘creation of advocacy groups’ and the need to ‘participate in the local joint development programs.’⁷⁸ It suggested three priorities to allow for planned and regulated access to Auroville: to develop some of the tracks to the ECR as pedestrian or cycle roads, to institute joint development committees for Koot Road-ECR and other link roads and develop the access road that links airport, Pondicherry to Auroville from the south. As we discuss in Part III.C, there was some movement along these lines from 2002 onwards as regards the proposal for a Regional or New Town Development Authority, yet regional planning remains a major lacuna in Auroville’s planning policy. The pressure of developments at Auroville’s doorstep today requires urgent and proactive measures. Insofar as internal mobility was concerned, the report pushed for a *via media* between a gated city and an unregulated one, with ‘urban nodes’ to ‘safeguard the pedestrian spine.’⁷⁹ In this, it suggested, broadly, though not entirely, in line with reports before and after:

- i. A ‘pedestrian / cycle ring road around the Matrimandir’ and incentivizing inter-zonal movement through internal linkages, reducing pressure on the Crown, which is the case today.
- ii. Regulated motorized circulation network for public transport, delivery and emergency services, with speed control by design along the Crown boulevard (street furniture, structured surface), that is shared with pedestrians and cycles.
- iii. Unrestricted access to Industrial Zone and Kottakarai village, unrestricted traffic along existing public panchayat roads, functional as the western outer ring road and

⁷⁵ Schmidt, 2003, 4.

⁷⁶ Planning Group, 2006, 2.

⁷⁷ Planning Group, 2006, 4.

⁷⁸ Planning Group, 2006, 6.

⁷⁹ Planning Group, 2006, 12.

self-regulating cul-de-sac traffic in each sector of Residential Zone, points on which there is variation and difference in the planning vision at this time.

- iv. Transition points between restricted and unrestricted circulation networks, with exchange nodes for internal motorized circulation network at the city entrance (except the Industrial Zone).
- v. The development of ‘social activity notes’, including public activity nodes (plaza) as concentration of the Crown activity at each zone and public activity nodes at sector level (communal neighbourhood centre).
- vi. Careful attention to three sensitive areas: first, for the social and functional integration of Kottakarai village and Bharatipuram settlement and the eco-sensitive Aurodam area, it suggested adjusting the urban mass, zonal limits and land use, though without clear proposals; and second, for the Revelation bio-reservat, it suggested adjusting the outer ring road. These issues have since continued to attract attention, with the 2014 Land Suitability and Land Use Proposal offering solutions, yet the issues remains as yet unresolved.

Following on this, in 2007, Revi suggested the institution of a mobility planning cell, to anchor work in Auroville.⁸⁰ At this time, the Dreamcatcher’s Forum, which we address below in relation to its community-driven process, developed the ‘Mobility Pearls’ and ‘Crownways’ Reports in 2007.⁸¹ The questions asked at the time were: how do we ensure that our ‘movement’ within Auroville is harmonious, beautiful and quiet? Would a ‘necklace’ be a more appropriate analogy than a ‘crown’? Should the Crown be noisy by default, and if not then what? Less technical and detailed as the work that preceded it, the Mobility Pearls presentation sheds light on the concerns and imagination, along the Crown and in general, animating (albeit limited) community efforts at the time. It registers four emphases:

- i. A permeable Crown: ‘whatever solutions emerge’, it notes, it ‘is important that the Crown remains permeable not only to ‘green’ and to the movement of people and animals, but also esoterically to the energies of Matrimandir.’⁸²
- ii. On the design of transport modules: it notes that the size and design of ‘public transport modules’ require attention, suggesting that ‘transport ‘pods’ might be a more appropriate image than ‘carriages’ – offering a more personal, intimate environment whilst theoretically being more adaptive and flexible’.⁸³
- iii. On Beauty: it emphasizes, with various suggestions to future exploration, the aesthetic element, to suggest that ‘our transport solutions have to become art in

⁸⁰ Revi, 2007, 6.

⁸¹ Mobility Pearls, 2009; Crownways, 2009.

⁸² Mobility Pearls, 2009, 1.

⁸³ Mobility Pearls, 2009, 1.

movement as well as developing movement as art’, pushing for a ‘mobility solution which is as light and playful’.⁸⁴

- iv. On Zonal transport: it suggests that ‘maybe each Zone could have its own form of transport’ such that ‘each Zone could also utilise the same basic solution but with a different appearance or ‘twist’.⁸⁵

It ends by suggesting that we ‘could draw-up a mobility ‘Mission Statement’ for Auroville, clearly outlining our priorities and our goals’.⁸⁶ It is unclear if the 2001, 2003 and 2005 works that preceded the Dreamcatchers forum, which were such ‘mission statements’, were considered at this time. In general, it seems often the case, as we see through our review in Part III that with some notable exceptions, previous studies often do not figure in later attempts.

The second ‘Crownways’ study provides a more detailed rendering of these ideas – in particular, it looks to ‘question this latest model of crown development and its mobility concern’, i.e., one where *only* the Crown / ‘inner city’ is proposed as a pedestrian area while the ‘outer city’, the Radials and the Outer Ring are open to vehicular traffic.⁸⁷ This seems to refer to the orientation in the 2006 Planning Group Report, though the 2001, 2003 and 2005 work by Schmidt-Billinger / Auroville’s Future, approved by Anger, takes a different approach by removing traffic for the entire area within the Outer Ring. This is an unresolved design debate today as well. Accordingly, it suggests, with Schmit’s 2003 work, ‘traffic calming measures’, a limitation of motorized movement in the ‘Green Radials’, ‘meandering Crownways along the Crown development area’, prioritization of public and non-motorized transport through the city with polluting traffic permitted only on a periphery and a concentration of new development in the Residential Zone Crown to ‘overcome dispersed development’.⁸⁸ This imagination, which draws from the ‘dynamic Crown’ idea of the 1965 Masterplan, proposes a ‘wider range of routing [that] allows a reasonable distance to existing features (buildings/private land)’ – as we discuss in section (viii) below, while all studies broadly agree on the need for conscious and beautiful mobility patterns sensitive to the aesthetic and social logics of space, the design difference in the imagination of the Crown between this ‘dynamic’ structure and a one that has ‘smooth’ edges seems to be an exaggerated fault-line.⁸⁹

⁸⁴ Mobility Pearls, 2009, 1.

⁸⁵ Mobility Pearls, 2009, 2.

⁸⁶ Mobility Pearls, 2009, 2.

⁸⁷ Crownways Presentation, 2009.

⁸⁸ Crownways Presentation, 2009, 16.

⁸⁹ Crownways Presentation, 2009, 14-20. *See*, Strategic Plan for Mobility on the Crown, 2019 for further development along these lines.

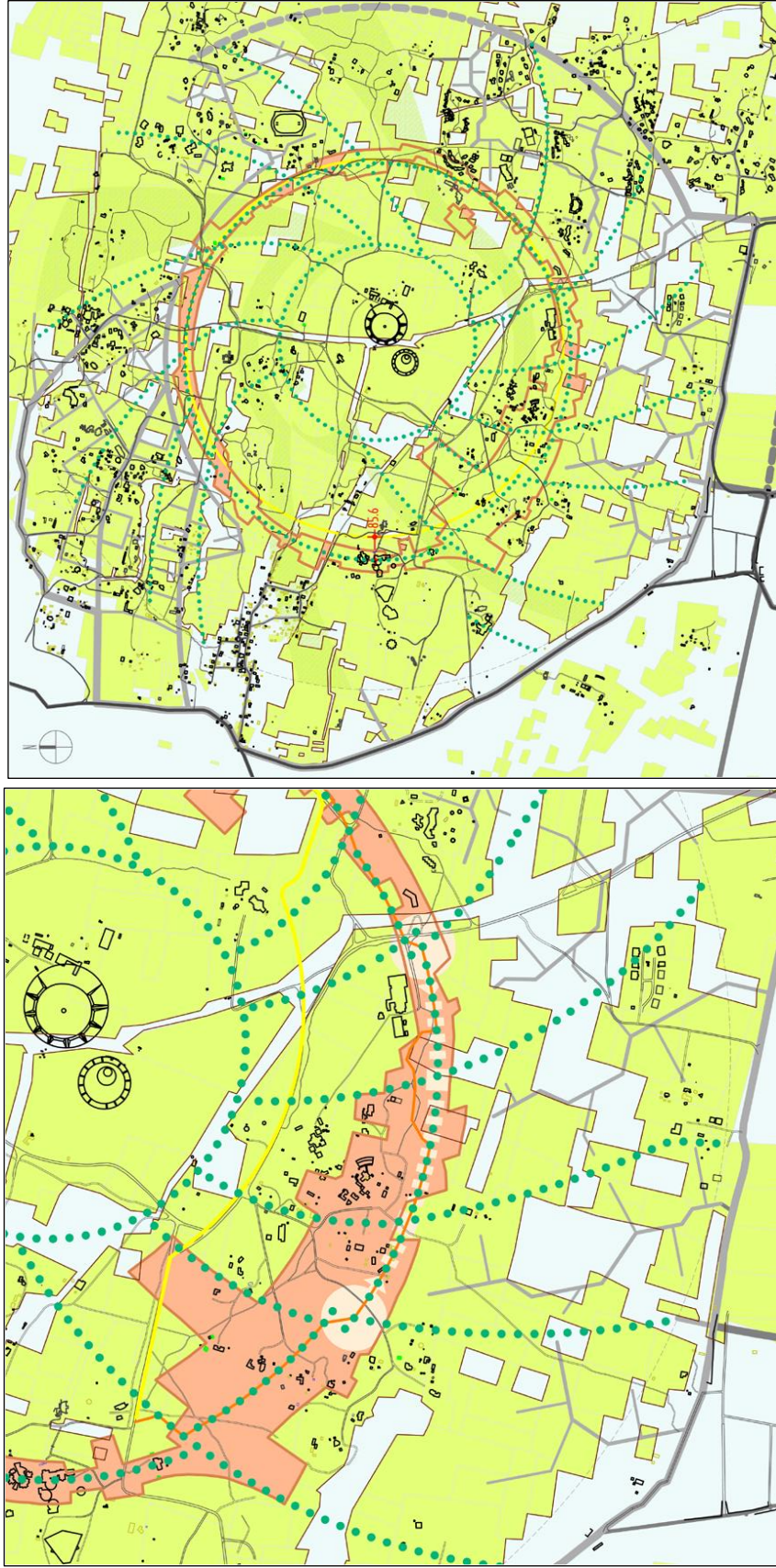

(Left, Imagination of Crownways. Right, bypass for node on the Residential Zone
Crown. Source: Crownways Presentation, 2007, 19, 20)

Following from these efforts, in June 2009, the Centre for Scientific Research, students of the Centre for Environment Planning and Technology, guided by Mr. Doshi ('CSR-CEPT Study') studied the traffic situation to gather data on volume count, directional flow and projections, examined the optimization of the network to provide for better mobility with minimization of the road surface requirement and sought to propose a medium and long-term mobility plan for the city.⁹⁰ In January 2009, Auroville Radio ran a discussion panel on mobility, and 'a group of Aurovilians met in a public forum to look at sustainable mobility'.⁹¹ In May 2009, a month-long workshop was conducted on the theme of creating a bicycle-friendly environment, resulting in a number of designs (bicycle accessories, a cycle path map, crossing and parking area prototypes).⁹² At this time, in November 2009, L'Avenir created a short list of priorities – for the development of the Crown, Radial and outer ring, with other short stretches from Crown Road to the Centre for Scientific Study and the Solar Kitchen to Matrimandir, each still pending – pursuant to their Road Map Study, which attempted to 'bridge' the Schmidt-Billinger concept into a road-plan.⁹³ Subsequently, in December, 2009, L'Avenir arranged a 'General Information Meeting' to present a detailed plan to implement the investment in roads and road related infrastructure, leading to the first (and till 2022, one of few) stretches of the Crown Road, from Solar Kitchen to Arka, being paved by the Road Service.⁹⁴ This was followed by the Integrated Sustainability Platform of 2010 that further explored the principles of mobility planning in Auroville, to emphasize mobility 'according to needs and character of each zone, in least intrusive manner ... that allows the least amount of internal interference to the street-life.'⁹⁵ As elsewhere, it prioritized 'human powered mobility' with 'non-human powered (motorized) transport ... only for public ('mass') transportation, the delivery of goods and services and emergencies within Auroville.'⁹⁶ Contrary to the 2006 Planning Group's approach, it suggested non-motorized movement within the entirety of the Outer Ring, leaving open the question of Kottakarai, Bharatipuram and villages in the Green Belt would be integrated. Interestingly, it suggested that aside from two Radials that would permit service vehicles and public transport from the Outer Ring to the Crown, the remaining ten 'will be preserved for their symbolism but as human powered movement links, routing like 'green fingers' from the green belt to the crown, meeting the crown at cross points with vistas to Matrimandir paths.'⁹⁷ Billinger and Schmidt had earlier suggested that this number be four, organized along the same non-motorized, public transport, lines as the Crown.⁹⁸ This remains an open design question today.

Finally, and importantly, between 2008-2010, the Austrian mobility expert Karl-Heinz Posch conducted a series of community-interactive workshops at the invitation of L'Avenir on a systematic approach to mobility management emphasizing the development of 'all streets ... using shared space principles' to encourage conscious movement and cohesive urban spaces.⁹⁹

⁹⁰ Ayer et. al., 2009.

⁹¹ Auroville Radio, 2009a; Auroville Radio, 2009b.

⁹² Centre for Scientific Research, 2009.

⁹³ L'Avenir, 2009a; L'Avenir, 2009b.

⁹⁴ Auroville Wiki, 2021.

⁹⁵ ISP Mobility, 2010, 1.

⁹⁶ ISP Mobility, 2010, 1.

⁹⁷ ISP Mobility, 2010, 2.

⁹⁸ Billinger and Schmidt, 2001, 13.

⁹⁹ Posch, 2011g, 94.

His team made an initial report in 2009, a further report in 2010 and a series of seven presentations on mobility planning options for Auroville with a comparative study with other cities in 2011.¹⁰⁰ In comparison with the original intention, Posch provided a ‘rather negative’ diagnosis that ‘the trend [in Auroville] is massively towards more and higher motorisation’ – while no general data was available at the time (nor as far as we are aware, today), the CSR-CEPT Mobility Study supported this view, finding that for three road segments, pedestrians and bicycles accounted for 8-10% and 20-35% respectively, whereas motorized transport (primarily two-wheelers) accounted for 50-65%.¹⁰¹ We may note that the 2022 Housing Survey seems to confirm Posch’s concern, with only 11.3% of all vehicles owned being electric, and 89% of respondents owning two or more vehicles. Posch thus emphasized the need ‘to install a systematic mobility monitoring and evaluation programme, with clear short, medium and long term targets’.¹⁰² He also cautioned that the upgradation of roads ‘will attract more motorised traffic to Auroville and so proper studies and monitoring systems should be in place before this is taken up.’¹⁰³ Accordingly, he suggested the creation of ‘one highly developed area that has street life’, including the New Pour Tous, Solar Kitchen, Library, Multipurpose Building and Kailash – in this, he mooted a ‘plaza concept’ and ‘concentration of development’ in that region on the ‘spine concept’, as with Anger, 1997, *Directions for Growth*, 2003 and Kundoo, 2007, through a detailed site development plan that could serve as a ‘test for shared space design and public space creation.’¹⁰⁴ The Billinger-Schmidt ‘general mobility plan’ was accordingly suggested, with a robust articulation of policy principles and some preliminary detailing out, in consonance with Auroville Future’s 2005 work.

¹⁰⁰ Posch, 2009; Posch, 2010; Posch, 2011a; Posch, 2011b; Posch, 2011c; Posch, 2011d; Posch, 2011e; Posch, 2011f; Posch, 2011g.

¹⁰¹ Auroville Wiki, 2021; Auroville Core Mobility Group, 2010, 11, 36.

¹⁰² Auroville Core Mobility Group, 2010, 20.

¹⁰³ As we discuss in section (viii) below, this is a planning concern, reiterated by Nightingale in 2020, for works on the Crown today that merits attention. Auroville Today, October, 2020.

¹⁰⁴ Auroville Core Mobility Group, 2010, 32, 17.

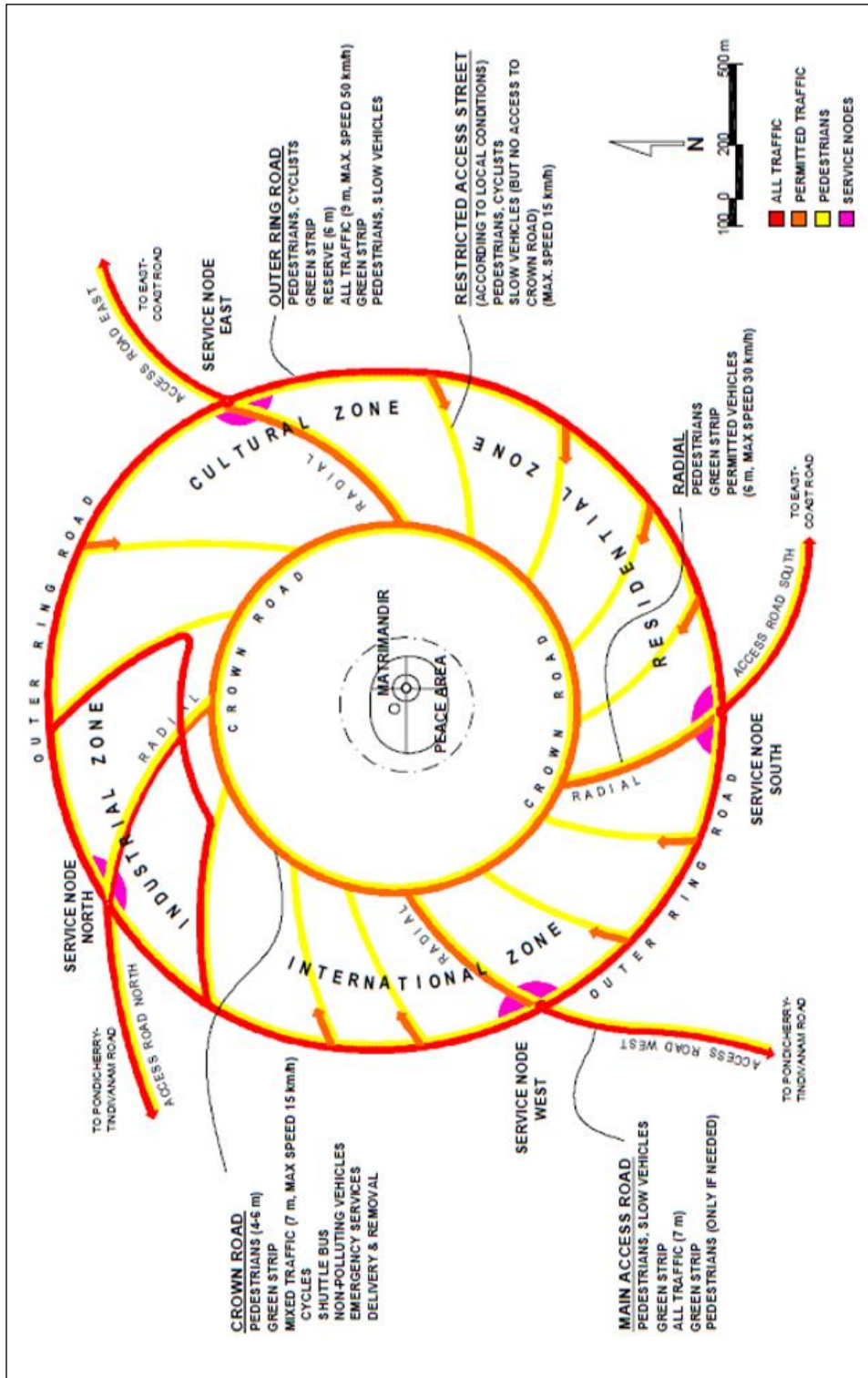

(General Mobility Plan. Source: Billinger and Schmidt, 2001, 12)

Posch / CSR-CEPT's alarming findings and projections did not result in action. It appears that this spate of work – from 2003 to 2010 – was too early for its time, with work for the demarcation of the Crown and Radials beginning formally only in 2009, and stalled in many sections till 2021, and community awareness on the need for mobility planning being limited. The records also do not indicate any substantive or awareness-generating work consequent to these proposals, aside from the Auroville Radio Panel Discussion. The proposal for a Mobility Integration Team, to lead these efforts, reiterating Revi's suggestion in 2007 and ISP in 2011, too did not translate in the institutional reworking of the TDC in the 2011 Standing Order.

As we address in more detail in section (viii), it is worth noting that the emphasis on quiet and conscious transport, with the city-centre and Crown serving as the centripetal social force, reflects the emphasis of early planning conversations between Mother and Anger. For example, in his first report on planning, Anger noted the necessity of defining the 'traffic principle', which was approved by Mother with a suggestion that only electric vehicles ply.¹⁰⁵ Anger proposed that:

The traffic principle needs to be defined right now. Should we allow the presence of cars: It is likely that in hardly a few years, India will witness, like Europe and the US, the major urban problem posed by the Automobile. The reign of car has conditioned the urbanism of the 20th century and continues to tyrannize it. Though it is outdated, and everyone knows it, the automobile does its best to create inferno within cities and to destroy the outside. The choice to be made now is therefore to forbid the use of this means of transportation within the town and replace it by another one, more healthy, less clumsy and noisy and more aesthetical, maybe more recent, if possible.

[Mother replied:] Small size electrically powered vehicles, capable of transporting about 200Kg at a speed of 15km/h.¹⁰⁶

As we discuss below, the absence of mobility planning in Auroville today – gridlocked amidst other planning disagreements – has led to the steady and unregulated increase of vehicular traffic on the Crown and other mobility networks contrary to this earlier imagination. Benchmarking it against Mother's early proposals, Anger's work in the 1969 planning study and later, the 2001 Masterplan, 2001 / 2003 Schmidt and Billinger and 2005 Auroville's Future studies, Kundoo's 2007 City Centre proposal, Karl-Heinz Posch's 2008-2011 recommendations, reiterated by Nightingale in 2020, 2009, Ayer / Doshi / CEPT study, 2009 Corwnways work, Feduchi's mobility proposals in 2014, Vastushilpa's 2022 presentation on mobility, the 2022 Dreamweaving Forum, the 2022 Mobility Forum and scholarship in mobility planning,¹⁰⁷ the current state of affairs appears to be moving *away* from the ideal, not towards it.

¹⁰⁵ Anger, 1965, 4.

¹⁰⁶ Anger, 1965, 4.

¹⁰⁷ See, for a review, Bertolini, 2023.

2. Proposal for City Centre Development

In 2007, Anupama Kundoo drafted a proposal on City Centre Development, which reflects the twin concerns to develop the urban form and planned mobility, each generating activity centripetally to an aesthetically inviting Crown.¹⁰⁸ The objective of the study consistent with Mother's early stewardship, was to suggest that:

a concentrated development of Auroville's City Centre is not only urgent for Auroville's collective focus, but also a very feasible, practical and economically advantageous option.¹⁰⁹

The City Centre proposal looked to detail out the visual elements of the Galaxy within the development goalposts of the Masterplan. It outlined circulation networks, distribution of built area and design guidelines for each of the twelve components proposed as part of city centre development, with the following features:

- i. The development of an Administrative Belt, with city service offices and housing quarters for staff for approximately 1500 personnel.
- ii. The development of the Centre for International Research in Human Unity.
- iii. The construction of vocational centres and offices in the Industrial Zone located along the Lines of Force stretching from the Green Belt into the city area.
- iv. Housing for a population of 1,250 along the Lines of Force in the Residential Zone.
- v. The development of the Crown itself, which, in line with Anger's original plan, is envisioned as the 'downtown' of Auroville, 'the very heart of Auroville's city life' with a rich assemblage of social infrastructure tuned to the profile of each zone.¹¹⁰ It bears noting that the City Centre proposal provides detailed design guidelines for the Crown in each zone, along with a transport circulation network (comprising a pedestrian boulevard, carriageway for active transport and non-polluting shuttle bus services and rickshaws at a speed of 15km/h). It emphasizes conscious and efficient mobility, with open spaces secured through a network of green corridors, parks and gardens.¹¹¹

¹⁰⁸ Kundoo, 2007.

¹⁰⁹ Kundoo, 2007, 8.

¹¹⁰ Kundoo, 2007, 48.

¹¹¹ There is, we may note, a natural and close correlation between Kundoo's proposal and Anger's early description of the Crown that serves as a benchmark for our analysis. *See*, Feduchi, 2014, 123 for Anger's description: 'Crown is to reflect the nature of the particular Zones of Auroville, nevertheless, entre Crown is to share certain qualities and atmosphere. Consequently, in all zones Crown is to function, primarily, as an area facilitating social interaction of Aurovilians. The urban fabric of the Crown is to be comprised of spaces manifesting following notions: PUBLIC SPACE restaurants, meeting halls, multi-use gathering halls ENJOYMENT cinema, theatre, music hall. PUBLIC SERVICE shops, post office, fire station, launderette. HEALTH emergency unit, nursing, diet advising center. RECEPTION guest houses, information center, hotels. ART gardens, open air performance spaces HABITAT. The Crown must not divide the town into sections and constitute a separating barrier, on the contrary it must become a shared space that unifies ... Consequently, it the

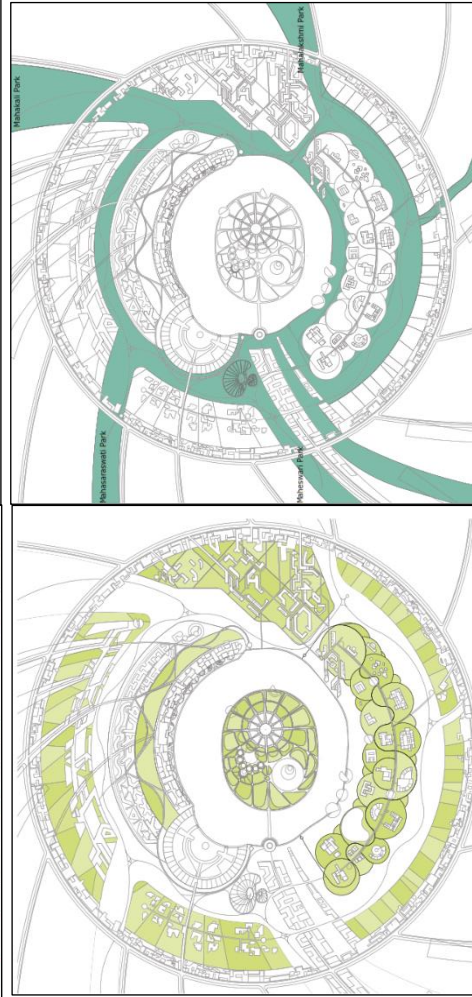

Top, visualization of the City Centre. Middle, building heights, with Lines of Force. Bottom left, arrangement of parks. Bottom right, arrangement of gardens. Source: Kundoo, 2007, 53, 24, 30, 31)

Crown will require, both horizontally and vertically, fragmented building fabric. The buildings will be held together by varied but unified architecture ...'

The records do not indicate any serious movement on Kundoo's proposal, either in the form of plans for implementation or community uptake. While it is beyond our expertise to assess the various proposals discussed above on technical grounds, what is evident as a matter of governance practices is the absence of structured planning processes to commission, consult, review and implement proposals – the natural life-cycle one would expect. Proposals may indeed be adopted *or* rejected, with alternatives taken up for implementation – yet, an ordered process to allow for such consideration, leading to execution, is conspicuous by its absence at this time. As we outlined in Part I, and discuss in greater detail in Part IV, robust community engagement with expert-driven proposals, guided by a centralized authority, is a practical translation of Mother's principle of illumined hierarchies – the absence of structured and time-bound processes as between the Planning and Development Group / Aurofuture / APDC and the community, for debate leading to decision-making and implementation, indicates either a lack of willingness or inability to self-organize. This is a constant, and worrying, feature of urban planning and governance in Auroville. A centralizing corrective is then both natural and necessary in Sri Aurobindo's scheme of things.

3. *Early Collective Planning Exercises*

The period from 2001 to 2010 also saw various community-led planning initiatives, which attempted to weave technical expertise with community vision, aspirations and lived realities. This was an early attempt to bridge the governance deficit discussed above. The Dreamcatching and Dreamweaving initiatives conducted between 2005 and 2009 are the leading example of a 'collective planning process' to facilitate the emergence of a common vision.¹¹² Funded by Stichting de Zaaier, they were driven by a belief in 'stimulating dialogue within the community, merging ground realities with the Galaxy master plan, synthesizing seemingly opposite viewpoints and (having) no fixed agenda.'¹¹³ This wave of projects emerged in response to three factors:

- i. The perceived bureaucratization of the Residents' Assembly where laborious discussions and divergent viewpoints made decision-making and effective participation difficult (or, as several conversants noted, the aspiration of consensus translating in reality to a veto).
- ii. The perceived domination of the discussion by a few groups or people – natural and expected concerns with minority capture in democratic arrangements outlined by Sri Aurobindo.
- iii. A felt need to go beyond planning as a 'technical exercise' following 'strict' design guidelines to make it 'dynamic and flexible' to current needs – the first elephant in the room on the so-called 'planned versus organic development' debate, discussed in Part II.

¹¹² Dreamcatching Presentation, 2005-2009, 3.

¹¹³ Dreamcatching Presentation, 2005-2009, 12.

The Dreamweaving Group held several ‘dream spaces’ between 2005-2009 – a form of an open-source planning tool, to allow for the emergence of a vision through collective engagement and imagination in a curated and silent space, with interested community members and technical experts. Different groups prepared community visions for the Sustainable Livelihood Institute, mobility networks, gardens around Matrimandir and the Crown. As one recognizes the value of its method, the practical edge of this exercise is unclear in the records it appears that none of these efforts was translated into formally approved or actionable plans. A detailed review of these experiments is beyond our scope here, but as with other city-planning initiatives at the time, participation appears to have been variable, with a gap between the culture of small-group democracy and formal, urban governance mechanism necessary for a translation of community input into a development plan.

4. *Persistent Questions*

The thrust of these early urban movements, still incipient and conducted on the fringes, speaks to several concerns. The first was the continued indifference to the Masterplan, or manifestation of the urban form generally, with little movement on these proposals and indeed, an intensification of the urban sprawl. The second was a growing recognition of the need for an institutional restructure: manifesting and implementing a shared vision for the ‘city’ required an appropriate rationalization and centralization of governance frames, yet one that seems to be resisted. The third was a persistent divide between community participation, limited at best, and even then, unstructured, and technical or professional expertise. The fourth was funding.

As we discuss in Part III.E, the commercial sector in this period comprised largely small, labour-intensive units, with insufficient surplus for infrastructure development and city-building. Yet it generated sufficient gains for increased investment in individual housing, which came up across the plan area absent a clear development plan, leading to concerns with unsystematic development not in step with the ‘Galaxy’, and growing numbers living outside the plan area, in outlying lands. Alongside, as government grants and foreign donations began to flow in, at an average of approximately Rs. 3 crores a year over 2001-2010, the beginnings of urban infrastructure emerged with the Visitor’s Centre, Town Hall, Solar Kitchen, limited collective housing projects, school buildings and research centres pursuant to the Pande Visiting Committee Report. While the general emphasis at the time was decidedly not on systematic city-building, as Thomas and Thomas note, a piecemeal proto-urban form began to take shape. By the end of 2010, with Anger’s passing, close to the end of what was imagined to be Phase I of the Masterplan and despite the various plans proposed, development continued to remain *ad hoc*. A structured DDP following the Masterplan had not yet taken shape.

Yet the varied approaches to planning that emerged in seed-form in this period reveal four central questions – inevitable in the governance of any urban collective – that continue to figure in debates in Auroville today with relatively little movement towards resolution: how should planning be undertaken in a way that preserves Auroville’s ‘urban’ character while heeding the ecological imperative? How does the executive mandate of a centralized planning authority, i.e., the TDC, relate to the legislative mandate of the Residents’ Assembly? Which institutional forms are appropriate to integrate technical expertise in urban planning with participatory community visioning? And finally, how are governance mechanisms to address altered

incentive structures to build, which range from a spectrum of mild indifference to active resistance? In the years that follow, from 2010-2015, these questions came to the fore as a catalogue of formal planning activity, through both participatory and expert-driven methods, failed to produce a DDP. We review these developments next.

vii. Attempts to Draft a Detailed Development Plan, 2010-2015

By 2010, the publication of the Masterplan in the Gazette and a growing unease with what was perceived to be a dilution of or deviation from Auroville's founding urban vision, lent an urgency to produce an integrated DDP, with calls to anchor this exercise in the proposed framework of the Masterplan. We review developments of this time, 2010-2015, in four buckets. The first was a push to restructure the TDC, with inputs from external experts and members of the TDC Advisory Group to outline the range planning and development efforts required. The second was the Integrated Sustainability Platform from 2009-2013. The third was the Implementation and Development Phasing Programme and Land Suitability and Land Use Proposal in 2014. The fourth, a notable summative effort, was the TDC's 2013 Development Plan for 2014-18. We conclude this section with a review of governance concerns that emerged in this more intensive period, leading to the next stage of planning efforts, starting with the Auroville Retreat in 2015.

a. The Constitution of the Town Development Council and Advisory Group

Headwinds to restructure the institutional architecture for town planning began towards the end of the first phase from 2001-2010. In late 2006 / early 2007, Aromar Revi, later a member of the TAG, proposed the following 'immediate tasks' in his 'Mission Notes', along with a blueprint of nineteen studies to be conducted, many of which are pending today as per the records made available to us.¹¹⁴

- i. An action plan and technical and financial proposals for developing a DDP by end-January 2008.
- ii. Development of the DDP by an internal team from Auroville, along with an external catalyst team of consultants.
- iii. Development of an adaptive implementation and financing plan for the DDP.

Later in April, 2007, the mandate for L'Avenir d'Auroville ('L'Avenir'), the successor to Aurofuture and the Planning and Development Committee, was adopted by a Residents' Assembly Resolution, with its formal constitution by way of Standing Order in 2008.¹¹⁵ As the first attempt to formalize, rationalize and centralize the institutional structure for town development works, the mandate document marks an important shift. The document outlines two goals for the L'Avenir: 'to plan, develop and construct the Auroville Township' and 'to

¹¹⁴ Revi, 2007, 9.

¹¹⁵ Mandate for L'Avenir d'Auroville 2007; L'Avenir d'Auroville-Auroville's Future, Auroville Foundation, Standing Order 1, 2008. There is a tension between the 2007 Residents' Assembly mandate and the 2008, later 2011, Standing Order – it is unclear which was operational, or if the latter superseded the former. This continues, as we discuss below, for the 2017 Terms of Reference for the TDC approved by the Residents' Assembly and the 2019 Standing Order. A harmonization is necessary.

plan and develop the socio-economic fabric of the Auroville Township'.¹¹⁶ The following key points emerge from the mandate:

- i. *Urgency*: the document registers a sense of urgency. It notes that the 'goal is to realize these objectives as soon as possible. Implementation will be phased, with one year, five year and other periodic plan phases.'¹¹⁷ As we discuss below, with the notable exception of the TDC's Annual Development Plan, 2014-15, these one year and five-year plans did not emerge.
- ii. *Commitment to the Masterplan and Galaxy*: the mandate identifies some 'overarching parameters' for town planning work.¹¹⁸ First, it forefronts 'respect for the key features of the Master Plan', which includes the Galaxy concept, given the relative indifference to the document in the first decade from 2001-2010. Second, it highlights three key concerns that resulted in development blockages in that period: the need for 'balanced, sustainable development, in all aspects – environmental, economic, social, physical', indicating a phase shift from the environmental imperative to a sustainable urbanism; for a balance between the democratic and technocratic impulses, with both a 'professional ... assessment of options' and 'wide participation'; and for 'sincere effort to integrate different perspectives', given the emerging divides between planning approaches from strict form adherence to the Galaxy to an entire reconsideration of it.
- iii. *Authority*: it sets up a 'management team' for L'Avenir, comprising coordinators across nine work areas, who are charged with inter-sectoral coordination and the power to 'make final decisions on development plans, projects and priorities' after consultation.¹¹⁹ Conversely, each coordinator to be held accountable for work, and in cases of disagreement, a two-thirds majority in the Management Team is required for a decision to pass. This explicit power to decide is notable, an expression of the principle of illumined hierarchies, given the absence of centralization of authority and unstructured discussions till that point. It does not seem however that this on-paper commitment translated into practice, with a continuing concern of weak executive and enforcement powers for the TDC recorded *ad nauseum* since and till date. Yet here too, the 2007 mandate is only a beginning, as it leaves open the question of disagreements between coordinators and individual residents or communities, in which case it anticipates dispute resolution mechanisms to be developed in time. This question, of dispute resolution and enforcement, which we consider in Part IV, remains unresolved today.
- iv. *Technical Competence*: the mandate repeats the emphasis in the 2003 Directions for Growth Report on the need for professional and technical competence to lead urban

¹¹⁶ Mandate for L'Avenir d'Auroville 2007, 1.

¹¹⁷ Mandate for L'Avenir d'Auroville 2007, 1.

¹¹⁸ Mandate for L'Avenir d'Auroville 2007, 1.

¹¹⁹ Mandate for L'Avenir d'Auroville 2007, 1.

planning, a sore point in the Auroville governance conversation till date. It anticipates ‘technical support staff for survey, mapping, data collection and sharing, environmental impact studies, urban design and architectural cell’, ‘sourcing and networking with relevant consultants for infrastructure (energy, water, waste, traffic, telecommunication, transportation etc.)’.¹²⁰ It also proposes ‘a common pool of technical and professional people with expertise that includes survey, mapping, data collection & management, drafts persons, architects, planners, engineers and infrastructure planners.’¹²¹ Crucially, it emphasizes that the ‘criteria required are competence and commitment to the task and teams’ – this again has been a continuing point of concern, with the 2022 Selection Guidelines for Working Groups in place currently adopting a popular selection process, rather than an expert-led assessment of competence.¹²² Alongside, it notes that ‘reference for positions in the organization will be given to qualified Aurovilians, Newcomers and long-term associates. If inadequate responses are received, the necessary professional and technical skills may be sought from outside Auroville.’¹²³ Competence and internal capacity constraints, both due to selection processes and insufficient professional expertise within the small-scale community of 3000 residents currently, have been voiced repeatedly over the last two decades, with a continuing reluctance to engage external experts (notable, as we discuss below, Mr. Doshi) or professionalize town planning works. The mandate also proposes an ‘advisory body’ of ‘inspirational individuals who are recognised innovative/original leaders and who would help Auroville leapfrog to the next level of planning and development’ – this body was constituted as the TAG in 2011, but records indicate that their advice was met with limited uptake, leading to an exit.¹²⁴

- v. *Institutional Maturity and Coordination*: nine work areas, each led a coordinator with executive authority to decide matters, was contemplated, to allow for institutional synergy and continuity as personnel change. There is a clear emphasis at this time to move from personality centric planning to an institutionalized approach, a chronic governance concern till date with personal dynamics playing far too great a role in how affairs are run. Interestingly, the document notes that for certain matters, including ‘town planning aspects relating to the main elements of the Galaxy Concept and the Master Plan’, Roger Anger’s ‘approval’ is necessary.¹²⁵ This demonstrates Anger’s pivotal, yet at times resisted, role in early planning. The document however notes, again in a push to greater institutionalization, that ‘referral of matters to Roger should progressively reduce as it is expected that an increasingly mature and capable Planning Organisation will resolve most issues while respecting the main elements of the Galaxy Concept and the Master Plan.’¹²⁶

¹²⁰ Mandate for L’Avenir d’Auroville 2007, 2.

¹²¹ Mandate for L’Avenir d’Auroville 2007, 3.

¹²² Participatory Working Groups and their Selection Guidelines, 2022.

¹²³ Mandate for L’Avenir d’Auroville 2007, 3.

¹²⁴ Mandate for L’Avenir d’Auroville 2007, 3.

¹²⁵ Mandate for L’Avenir d’Auroville 2007, 4.

¹²⁶ Mandate for L’Avenir d’Auroville 2007, 5.

As we discuss in Part IV, Auroville's governance systems, in planning and across all sectors, are yet in their early stages, yet to reach maturity. This is driven, *inter alia*, in no insignificant part by sentimentalism and resistance to centralize authority. On the management side, the mandate recognizes the need for regulatory compliance, fund management, administrative support, reporting systems, IT-enabled systems – as we discuss in Part IV, these rather elementary concerns continue to persist, for which a robust governance dashboard, enterprise resource planning solution and data management system is an easy and necessary fix.

- vi. *Socio-Economic Planning*: as we discuss in Part III.F, Auroville's commercial setup began to stagnate in the early 2000s; the 2007 mandate responds by tasking the L'Avenir to 'conceive, plan, develop and implement economy models and processes in line with the Auroville Vision.'¹²⁷ It remains unclear from this stage onwards till date as to the division of work on economic planning between the TDC and FAMC, each of which have a vast catalogue of other responsibilities. We suggest a restructure of mandates below, to task a standalone group with the competence and skill required to anchor this task.
- vii. *Regional Development*: there is a growing recognition at this time for networking with other agencies – from the panchayat to the national level – to counter the insular approach that settled in post the 1990s in several sectors. The aim was to 'enable Auroville to have an active voice in the regional development', an issue that persists till day with both the 2007 Villupuram and 2019 Pondicherry development plans referring to Auroville only as a tourist destination.¹²⁸
- viii. *Fundraising, Networking and Liaison*: the early support of the Asia Urbs programme, Stichting de Zaaier and Government Plan Grants provided town planning a fresh impetus, yet funding concerns have been constant with an undercapitalized economy. The mandate thus focuses on the need for a separate vertical to 'actively pursue fund raising targets', with monitoring and evaluation of expenditure, both of which continue to remain concerns today.¹²⁹ We discuss this below.

Progress in these years, this governance restructure notwithstanding, remained slow, with on-paper mechanisms not translating to on-ground operational patterns. A fresh impetus to town planning came three years later with the notification of the Masterplan in the Gazette on 28th August, 2010.¹³⁰ The first push, as far as the records indicate, came from L'Avenir's advisors. In November, 2010, Mr. Dattatri, ex-member of the TCPO, who had played an instrumental

¹²⁷ Mandate for L'Avenir d'Auroville 2007, 2.

¹²⁸ Mandate for L'Avenir d'Auroville 2007, 2. See, Villupuram District Human Development Report, 2007, 126; Comprehensive Development Plan For Puducherry Planning Area – 2036, 281.

¹²⁹ Mandate for L'Avenir d'Auroville 2007, 3.

¹³⁰ For a short discussion on the legal implications of the notification in the Gazette, *see*, the discussion in Section (iii)(c) above.

role in finalizing the Masterplan wrote to members of the Governing Board and L’Avenir.¹³¹ The ‘first step needed’, Mr. Dattatri noted, was to establish the Town Development Council, the implementing authority under the Masterplan.¹³² This was done on 1st May, 2011 largely in consonance with Mr. Dattatri’s suggested composition, by the administrative mechanism of a Standing Order issued by the Governing Board.¹³³ Alongside, the L’Avenir Advisory Group – later reconstituted as the TDC Advisory Group (‘TAG’) by Standing Order 9 of 2011 – made an outline presentation entitled an ‘Aesthetic Journey into Creative Urban Planning’ in November, 2010.¹³⁴ The thrust of these efforts, which we will not rehearse in detail, was largely similar to the 2003 Directions for Growth Report: to strengthen the institutional architecture, particularly with the passing of Anger in 2008, and implement workstreams across town planning and urban design, infrastructure construction and maintenance, research on sustainable development, implementation and monitoring and resource mobilization and networking. It bears noting that there was a conscious shift in orientation at this time from the hitherto central focus on physical infrastructure/urban design to city-building as a socio-economic endeavour: as the economic and housing stagnation since the early 2000s intensified by this time – despite repeated cautions and proposals by Lamba in 1997, Economy Group in 1998, Thomas and Thomas in 2002 and 2008, and other discussed in Part III.F – material concerns came to the forefront. The Integrated Development and Phasing Programme, 2014, registers this shift:

... through informal consultations with individuals, groups, and advisors the importance of economic sustainability surfaced repeatedly as one of the highest priorities for the next phase in Auroville’s evolution.¹³⁵

The stark contrast between the rapid development of the neighbouring areas and the rather glacial pace of Auroville’s growth is reflected in the Full Report of the 2015 Retreat, which notes the terms of the debate at the time:

13	Auroville must be completed within a time frame (city and society). If we do not hurry up the outside world will crush Auroville or reduce it to a suburb of Pondicherry.	Auroville must develop at its own pace. Timelines and targets do not work here.	<i>Work with plans that include quality, quantity and time parameters and revalidate these plans periodically.</i>
----	---	---	--

(Source: Full Report, Auroville Retreat, 2015, 66)

¹³¹ Dattatri, 2010.

¹³² Dattatri, 2010, 1.

¹³³ Auroville Foundation, Standing Order No. 6, 2011.

¹³⁴ L’avenir d’Auroville Advisory Committee, 2010.

¹³⁵ Kalra, 2014, 4.

Whilst the records do not indicate a decisive shift in the community to address these matters, or those raised by the TDC's advisors, a series of planning studies were commissioned from 2011 to 2015 to build momentum towards a DDP.

b. Integral Sustainability Platform, 2009

The Integral Sustainability Platform ('ISP'), initiated in 2009, was funded by the TDC with the aim to produce a Five-Year Development Plan for 2010-2015 *for each sector* of the city.¹³⁶ This was an ambitious – albeit significantly delayed – city-wide move to implement the planning strategy outlined in the Masterplan. It was initiated at the end of Phase I under the Masterplan (2001-2010), without any significant progress till then on the metrics discussed in our annotated summary above.

The central question driving the ISP was not one of how to manifest the urban form of the Galaxy, but rather to build the socio-economic foundation: 'how can Auroville utilize better its existing resources and aspire to become self-sustainable?'¹³⁷ To this end, it identified five-year targets across eighteen sectors, broadly categorized under physical infrastructure, social infrastructure and natural environment. Further, it presented a process of decision-making wherein planners function 'not as decision-makers but as a supporting service to the community', leaning strongly towards decentralization.¹³⁸ This addressed two important governance issues: (i) the placement of TDC as a mediator between planning experts and the community, codified later in the 2017 Terms of Reference adopted by the Residents' Assembly, which we discuss below, and (ii) the distribution of decision-making powers between the community (or Residents' Assembly, not distinguished in the ISP) and the TDC / Working Groups, which we consider in Part IV. While necessary, decentralization efforts raise concerns with dissipation and coordination, on one hand, and accountability and competence, on the other, each exhibited in Auroville's setup at that point in time, as today. These require careful handling.

Eighteen teams were constituted – one for each sector – comprising five to eight Aurovilians and newcomers who were 'experts' in their fields, with an impressive total involvement of over 120 residents, demonstrating relatively wide community participation. Each team was tasked with producing a five-year development strategy for their sector. These proposals were to lay the base for the creation of 18 permanent bodies under the Working Committee, which would be allocated resources and responsibilities.¹³⁹ The ISP was to be dissolved within a year, after which the eighteen bodies thus created were to function independently. It is unclear how this proposal relates to Appendix V of the Masterplan or the 2011 Standing Order, with both appearing to operate in parallel streams. In any case, this attempt at institutional reengineering did not take off.

¹³⁶ Dinur and Alon, 2019.

¹³⁷ Dinur and Alon, 2019, 1-2.

¹³⁸ Dinur and Alon, 2019, 34.

¹³⁹ As we discuss in Part IV, the standard practice of placing a range of responsibilities on the Working Committee, as a *de facto* super-regulator, coordinator and residuary body, is inefficient and ought to be discontinued. The mandate of the Working Committee must be clearly defined and limited to matters of external liaison.

The ISP provided the following overall recommendations for Auroville's growth. In this, it served as a precursor to the 2015 Retreat, which we consider below, with substantial overlaps in the findings of both (though the findings of the ISP were not, to the best of our understanding, discussed at the Retreat, leading to some duplication of efforts). In both cases the results were not translated into action:

- i. Clear economic guidelines to encourage income generating activities in line with Auroville's ideals and revive the role of the Auroville Board of Commerce.
- ii. Strengthen relations with nearby villages in the bio-region by setting up strong representative bodies on both sides, to liaise and collaborate on different issues from forestry, economy, education, social development, etc.
- iii. Encourage collaboration among different sectors while establishing clear guidelines (policies, legislations) in each sector to make them self-sustainable.
- iv. Clear Land Policy to accelerate the securing of remaining lands to further development.

In addition, it made over two hundred sector-wise recommendations.¹⁴⁰ This integrated, cross-sectoral approach was a valuable translation and development on the lines of the 'systems engineering approach' in Mother's Ford Foundation letter. In recognizing and attempting to work through the cross-linkages, with community involvement, the objective was to generate a *cohesive* action plan for the city, hitherto developing in scattered ways.

¹⁴⁰ We incorporate these into our development priorities in each sector as appropriate, but note a sample of important points for action below that give a sense of the planning direction at the time: (i) mobility: establish a mobility steering group to build a Green Grid, with service nodes for parking, cycles and storage; (ii) water: establish a Water Board to implement water policies; (iii) energy: establish an Energy Board to set up an energy fund and a sustainable energy educational programme; (iv) waste: develop educational programmes for schools and the general public in waste management; implement new waste management guidelines for new housing projects; (v) architecture and planning: formulate a green building and infrastructure policy; create user-friendly Masterplan and planning guidelines; create a Board of Architects; (vi) education: develop teacher-training programmes based on integral education, ecological expertise and progressive Indian educational programmes; (vii) economy: establish Friends of Auroville commercial status; explore how to partner with external companies; develop transparent criteria for investments and funds; (viii) culture: develop a financial support strategy for arts in Auroville; (ix) communication: improve collaboration between the various media, develop communication infrastructure project; (x) village outreach: expand cultural exchanges between Auroville and the villages; develop a model village with alternative energy products; coordination body to mediate between working groups and the villages; (xi) forestry: create larger managed forest areas; accept gaps and additions to Masterplan as carbon sinks; appoint forest coordinator to communicate and fundraise; (xii) farms: offer certification for organic food, promote training of village farmers, promote urban farming in city area; (xiii) housing: expand fundraising; create housing assets management policy; (ix) food: open more distribution centres; expand relationships with the bioregion; (x) health: set up a Health Board to coordinate the health sector and develop health education programmes; (xi) guests to newcomers: transparent financial overview of all guest-related activities through centrally coordinated handling of all income and expenditures; establish different categories (Friends, residents etc) for joining Auroville.

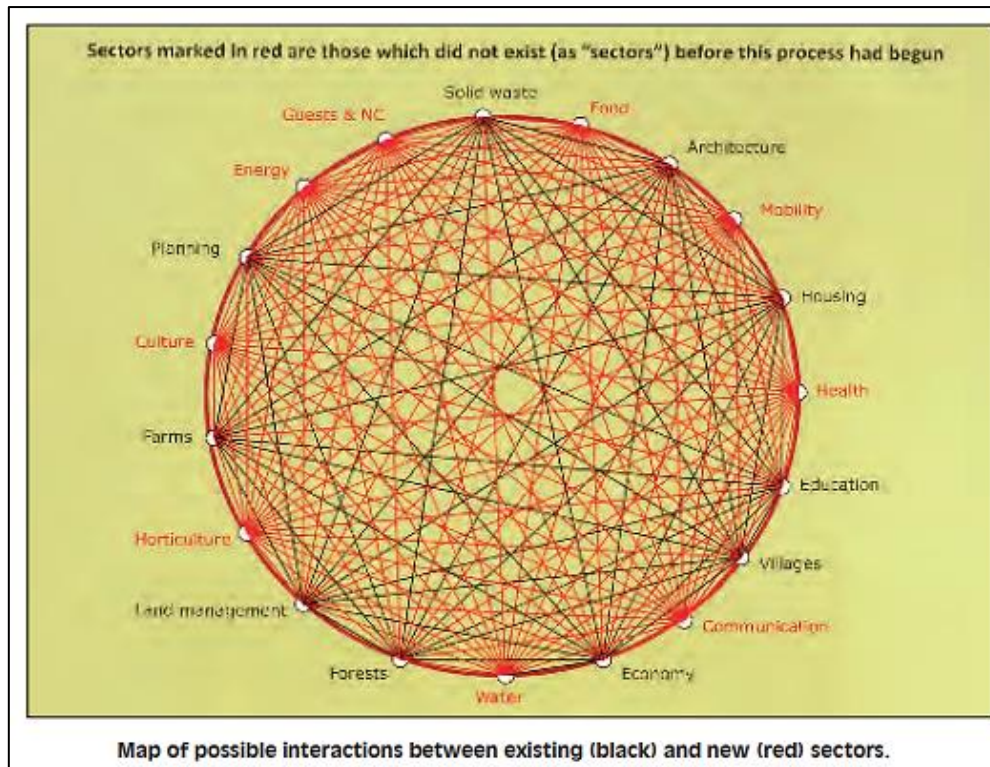

(Sector cross-linkages in the ISP. *Source*: Auroville Today, November, 2014, 3)

Aside from its sector-wide recommendations, the planning process in the ISP merits attention. Like the 2005 Dreamcatching forum, it was notably a collaborative, community-driven planning initiative. In an interview with *Auroville Today*, the authors of the ISP considered the tension between centralized and decentralized planning methods, providing a practical arrangement to our discussion of Sri Aurobindo's views in Section I.A:

[Question: What will this new organization look like?]

The idea is not to create a top-down management structure but the opposite: the decision-makers will be the people from the sectors. There will still be a role for a body like L'Avenir d'Auroville but it will be a facilitating role. In fact, we are in discussions with L'Avenir at present concerning recognizing each of the 18 sectors as decision-making bodies ...

[Question: The main criticism of the ISP approach is that it is impractical. For example, there have been attempts in the past to get different groups to work together but most of them have failed because some people want to keep control over their own area or project. Why should it be different this time?]

At the beginning of this process there were people who told us it would not work and that we shouldn't waste our time. Now, as a result of the ISP, one of the biggest sceptics has created a huge project involving collaboration between different sectors, and there are many other stories like this. So I think the reality is that many Aurovilians have been waiting for something like this for many years. Of course there are fears and concerns about the next step, but the wish to try something different is even stronger ...

... if the community is really serious about taking Auroville to the next stage of its development, these forty maintenances are the absolute minimum. We really need a new organization to support further development.¹⁴¹

Given the common complaint in the Auroville community, voiced in several interviews, of ‘top-down’ planning approaches driven by experts – the expected democratic feedback to the technocratic impulse – the ISP should have translated into action as a reflection of that aspiration met. Yet, here too, it seems that despite robust community engagement, no mechanism (or intention) for follow-up action emerged across the major action points listed above. The forty maintenances required – approximately Rs. 6 lakhs per month – did not materialize, nor to the best of our knowledge, was a fundraising program instituted to move in that direction.

Therefore, at the end of the ISP, an integrated five-year Development Plan for 2013-2018 did not materialize. Records indicate that this lack of movement can be traced to four factors: (i) a general lack of urgency or inertia, (ii) a reluctance to increase population densities and invite new residents for fear of spatial conflict, (iii) the absence of a centralized and empowered body tasked with translating studies such as the ISP into action, and (iv) the absence of a funding mechanism to generate the required investment, with weak movement to address structural concerns in the commercial sector. What emerges insofar as governance is concerned is as follows: if a process such as the ISP that invites and generates community participation does not translate into action, particularly once action points are agreed upon after input and deliberation, subsequent moves to institute appropriate centralizing correctives are required to introduce necessary efficiencies.

c. Implementation and Development Phasing Program, 2014

With limited community uptake of the ISP, the TDC commissioned a new Implementation and Development Phasing Program (‘IDPP’) in 2013, with the aim of charting a five-year Development Plan for 2014-2018. The stated aim was to create an ‘overarching framework through which TDC will plan its course of action for the next 5 years.’¹⁴² The precise reason for launching another effort with a similar focus as the ISP, without first acting on its recommendations, is not apparent from the records.

After the ISP, an urgent need was felt to re-orient the focus of Auroville’s development from ‘infrastructure/physical investments’ to ‘strengthening the community’s existing capacities and ... broader economic sustainability’.¹⁴³ This approach emphasized the immediate socio-economic development as a pathway to manifest the urban form of the Galaxy. In contrast to prior works, the IDPP focused on immediate economic concerns:

The focus of the strategies proposed in the IDPP goes beyond the approach of identifying only infrastructure/ physical investments needed to build the city for an ultimate population of 50,000 residents. Instead, the IDPP concentrates on exploring opportunities to prioritize investment in strengthening the community’s existing

¹⁴¹ Auroville Today, November, 2014, 3.

¹⁴² Kalra, 2014, 4.

¹⁴³ Kalra, 2014, 4.

capacities and focusing on broader economic sustainability with relatively reduced investment in provision of physical infrastructure in the short to medium-term.¹⁴⁴

This was a response to concerns, voiced earlier, that Auroville's sustainability and short-term security were suspect, given the slow rate of population growth. Immediate measures to secure financial sustenance were seen as a tool to attract the necessary talent and capital to boost city-building:

In the present day, the slow paced growth of the Auroville community has become an increasing concern; as it renders the functioning of the community, at many levels, highly unsustainable. With the onset of the Golden Jubilee (50th Anniversary) of Auroville's inception in the year 2018, it becomes imperative to collectively reflect upon the present state of affairs & consequentially project into the immediate future an enabling environment which would attract the people that share the values set forth in the Auroville Charter.

...

This may include: focusing on TDC taking a new role of acting as the agent that will successfully be able to create an enabling economic environment that provides greater economic freedom and increase opportunities for entrepreneurship to its residents ... [and] strategic physical infrastructure investments may need to be aligned directly with local economic opportunities such that we ensure that Auroville will transition into a self-sufficiency mode of operation hinged upon the community's strengths and capability to generate internal resources with minimal reliance on external resources.¹⁴⁵

As several interviewees noted, a sense of frustration borne of limited movement on the Masterplan had settled in many collective for a by this time. Accordingly, the IDPP fore-fronted the need to 'reconnect ... the current population of 2,500 residents with the purpose of building the 'city of the future.' With its twin focus on economic development and reconnecting with the vision, the IDPP recommended 108 action proposals and strategies across nine strategic focus areas, many overlapping with the ISP: (i) collaborative economic growth and development, (ii) sustainable land development, (iii) integrated planning and design, (iv) collective mobility and non-motorized systems, (v) affordable co-created housing, (vi) sustainable infrastructure and service delivery, (vii) regional synergies, (viii) good governance and inclusive citizen involvement, and (ix) well managed city implementation, monitoring and evaluation.

The IDPP advocated for the TDC to play a new role in 'enabling economic opportunities' (though again the link between the TDC and FAMC is left unclear) and for physical infrastructure investments to be made in line with local economic opportunities to ensure self-sustainability.¹⁴⁶ Coming up on Auroville's 50th year, as part of the Auroville Vision 2018, the plan was to target a modest population growth of 5,000, beginning with the least dense Residential Zone Sectors 1 and 2, which could then serve as models for further development.¹⁴⁷

¹⁴⁴ Kalra, 2014, 4.

¹⁴⁵ Kalra, 2014, 5.

¹⁴⁶ Kalra, 2014, 5.

¹⁴⁷ Kalra, 2014, 4.

A DPP for these sectors was prepared at this time by Feduchi, along with the Land Suitability and Land Use Proposal discussed above that provided detailed population distribution targets for these sectors. We address it in Part III.D.

The IDPP focused on the economy-housing-growth vicious cycle (low population numbers leading to slow development, absent benefits of scale, with capital unavailable to build new houses, further leading to low population numbers owing to financial entry barriers and self-selection of those with pre-earned capital).¹⁴⁸ This point has been made in most development studies since, including the Masterplan. For example, Revi notes in 2006:

A lack of affordable housing and a possible deficit in available consumption expenditure from the basic ‘wage’ paid to Aurovilians are possibly serious constraints to younger people joining Auroville and enabling the aspired growth in populations to a critical mass.¹⁴⁹

The Governing Board has also frequently addressed this issue, for example in its meeting on 7th April 2013:

The Board has directed that the Auroville TDC to give top priority to affordable and sustainable housing for new comers and Aurovilians and speed up the completion of sanctioned projects.¹⁵⁰

With this practical short-term approach to anchor developments in 2013-18, the IDPP was presented both to the Governing Board, which urged the development of a DDP, and to the community, with the hope that:

An attempt [can be made] to integrate geophysical reality and social and economic development into the design of the galaxy, the Implementation & Development Phasing Program (IDPP) will be the foundation of the Detail Development Plan. This project is a draft that will go back to the community for feedbacks and it was made clear that ideally more people will get involved with city planning.¹⁵¹

More people, however, did not get involved. Nor, as far as we are aware, did the process of community feedback result in a consensus amongst the community on the need for a DDP. Thus, with the IDPP, as with other similar initiatives, the problem lay not with the proposals for action, but with institutional inertia in decision-making and implementation, which continues to act as a bottleneck.

d. TDC Development Plan, 2013

With the series of planning work post the notification of the Masterplan in 2010, a series of meetings between the Governing Board, Secretary, TDC, TDC Advisory Council and Working Committee, were held in July, 2013. The aim was that ‘these studies will be integrated into a unified vision and presented to the community by October-November’, in the form of a 5-year DDP.¹⁵² Alongside, as we discuss in Part III.C, negotiations on the New Town Development

¹⁴⁸ Kalra, 2014, 14-23.

¹⁴⁹ Revi, 2007, 3.

¹⁵⁰ Auroville Foundation Annual Report, 2013-14, 8.

¹⁵¹ See, TDC Presentation to Governing Board. See also, Doshi, 2015.

¹⁵² L’avenir, 2013a, 3-4; Town Development Council and TDC Advisory Group, 2013, 1.

Authority gained steam at this time, prompting a letter from Mr. Doshi, Chairman of the TDC, to Dr. Singh, Chairman of the Governing Board, that a DDP could be prepared within one year from the finalization of the statutory protection, as mandated by law.¹⁵³ In addition to the studies discussed above, the Annual Reports of the Foundation indicate a range of other preparatory studies.¹⁵⁴

Summing up this work, the TDC drafted the Annual Development Plan, 2013 ('ADP-2013'), forecasting works for 2014-18.¹⁵⁵ The ADP-2013 is a valuable practical document that merits reflection, with a sector-wise overview of development and, unlike several 'planning' documents, with precise budgetary estimates and timelines for its proposals. It is a realistic and sober assessment of Auroville's planning needs and limitations. It is not a development plan *per se* but a precursor to one.

1. *The Proposal*

The ADP-2013 examined the economic viability of advocating a 117% rate increase in population growth (from the existing 2,300 residents to 5,000 residents) by making income projections from current trends. Conversations with members of the TDC indicated that it did not materialize, due to lack of executive powers and the absence of a co-ordinated planning approach, signalling again a lack of both organization and intensity as well as willingness amongst the community. The ADP-2013 notes:

The urban design with a Galaxy shape is a symbolic aspect of this vision and needs to be integrated with the geophysical reality and the socio-economic development aligned with the original vision of the Mother. Some studies (integrated detailed development plan, surface water management and land use) have been made with the

¹⁵³ Doshi, 2015, 2.

¹⁵⁴ We note here studies that we have been unable to locate despite our best efforts; in most cases, members of Working Groups we interacted with were also unaware of their existence. APDC proposal with regard to future housing development with the city area (Annual Report, 2004-5, 11); five year plan (2012-17) for infrastructure, housing and public funding, Annual Report, 2010-11, 98); layout for the Residential Zone foreseeing a population of 5,000 residents (Annual Report, 2010-11, 11); study on affordable housing (Annual Report, 2012-13, 16); Plans for Green Cabash Housing Project (Annual Report, 2012-13, 16); outline of the scope of work for the five-year development plan containing the parameters and broad lines required for drafting a 5-year or 3000 population plan (Annual Report, 2004-2005, 10); preliminary studies conducted for the 5-year Development Plan, 2007-2012 (Annual Report, 2005-2006, 14); mapping of development requirements of villages around Auroville based on harvest studies (Annual Report, 2006-2007, 8); Auroville Database including mapping of existing features and utilities of all 4 zones, spatial study/maps of 12 lines of force, study of environment, land use and land ownership of 'proposed Village Model' project, preparation of studies for Crown Road levels and service roads (Annual Report, 2006-2007, 8); plans for Residential Zone-Sector 2 (Annual Report, 2007-2008 AR, 6); assessment of Auroville from an environment and development perspective by L'Avenir core group of coordinators (Annual Report, 2008-2009, 10); estimate of detailed dev needs for the next 5 years plus template modelling for budgeting for estimated growth (Annual Report, 2009-2010, 13); socio-economic development surveys including a survey on student population and jobs, survey on Auroville business units, and a population 'prognosis' (Annual Report, 2009-10, 13); study of major public and private buildings (Annual Report, 2009-2010, 13); guidelines for future development of area outside Master Plan area (Annual Report, 2009-2010 AR, 13); plan for the International Zone (Annual Report, 2009-2010, 13); status and direction paper on Urban Planning (Annual Report, 2009-2010, 13); residential zone planning research and scenario generation (Annual Report, 2009-2010, 13); five-year plan (2012-2017) prepared for infrastructure, housing and public buildings (Annual Report, 2010-2011, 98); strategic plan for 2010-2012 prepared envisioning creation of clusters and nodes of development inside Residential, Industrial and International zone; consolidation of sports and education facilities in Cultural Zone (Annual Report, 2010-2011, 98).

¹⁵⁵ TDC Annual Development Plan, 2014-2015.

aim to integrate them with the urban design concentrating a special focus on a part of the residential zone which should host 5000 people and serve as a pilot. The aim is to achieve growth in quality and not only in quantity, consciously willed, researched and encouraged, to make the Auroville ideals a more dynamic reality.¹⁵⁶

Accordingly, it proposes a 117% population growth target, from 2,300 residents in 2013 to 5,000 in 2018, and projects a concomitant economic growth in that period to enhance the carrying capacity, from Rs 1,085 lakh in 2013 to Rs 2,011 lakh in 2018 – a 95% increase.¹⁵⁷ Given a proportionate rise in expenditure in social services (education, city services, health, etc.) and a conservative estimate of a 60% increase in ‘non-proportional’ costs in other sectors (organization, forests, land, security, etc.), it projects a 96% increase in expenditure – from Rs 1,069 lakh to Rs 2,095 lakh. (Note: surprisingly, this is perhaps the first documented effort to conduct this practical exercise, which is a basic requirement for any planned expansion).

BUDGET PROJECTION FOR 5000 PEOPLE			
	2012-2013	2017-2018	Variation
Population	2,300	5,000	+ 117%
EXPENDITURE 2012-13	2012-2013	2017-2018	Variation
Proportional costs			
Education	221	480	+ 117%
Children & Youth	111	242	+ 118%
Social Services	69	151	+ 117%
Health	90	196	+ 118%
Other	177	384	+ 118%
Non-proportional costs			
Organisation	99	158	+ 60%
Village education	83	134	+ 61%
Forests	63	101	+ 60%
Land	38	61	+ 60%
Security	34	54	+ 59%
Other	84	134	+ 60%
Total Expenditures	1,069	2,095	+ 96%
Surplus	16	16	+ 0%

(Budget projections for 117% population growth target. *Source:* Town Development Council Development Plan, 2013-2014, 6)

Assuming that Government Plan Grants remain stable (given trends over the past five years), ADP-2013 concludes that the current economic setup will be unable to accommodate an increase in population absent a capital investment to enhance capacity and encourage new commercial units.

An increase in population by 117% does not on short term create enough income to cover the extra cost of this increased population. Each new Aurovilian will give a contribution to the Central Fund, but as contributions only covers 17% of the total budget, this is far from being enough to cover the increase in expenditures. We have

¹⁵⁶ TDC Annual Development Plan, 2014-2015, 3.

¹⁵⁷ TDC Annual Development Plan, 2014-2015, 4-6.

in our projection been optimistic on how much Financial Service, Other Services and Guesthouses can increase their income and contribution. Even so, commercial units have to more than double their contribution when we reach 5,000 inhabitants in order to match foreseen expenditures. The trend in the last year has been a stagnating contribution from commercial units, so it seems very unlikely that this should be possible. When the new Aurovilians move into existing units and create new units, there will be a potential for generating more income and higher contribution, but there is a time lag in both for people to get into action and new investments have to be recouped before contribution starts. The projection shows clearly, that a large expansion in Auroville population, will create a huge deficit in budgets unless the commercial units are helped to dramatically increase their income and contributions. This would need a large and focused effort in assisting units, existing and new, on all levels also financially.¹⁵⁸

This recurrent theme cyclical stagnation is key to correct for Auroville's growth. This concern has been voiced repeatedly since the 1999 Residents' Assembly Masterplan. It is usually attributed to the absence of 'normal self-financing mechanisms through taxation' and the 'important role' commercial units can play in becoming 'a self-supporting town'. However, there have been no proposals since to expand population numbers and optimize the participation of commercial units in income generation, leading to the situation described by the ADP-2013.

2. *Development Blockages*

ADP-2013 identifies obstacles to growth that have prevented a phased increase in population numbers and the implementation of development plans listed in the Masterplan.¹⁵⁹ These are consistent with our research:

- i. The absence of an agreed-upon, fully elaborated framework of processes and parameters for implementation of Mother's vision.
- ii. Difficulty to harness residents' support to embark on action-oriented planning practices and a collaborative governance system.
- iii. Lack of clear responsibilities, with work not being assigning to capable individuals and inability of Working Groups to deliver due to weak powers of enforcement.
- iv. Inability to reach a critical mass required for self-sustaining growth, with limited success in attracting talent and investment.
- v. Regulatory overlap, with multiple committees, task forces and study groups with overlapping mandates, without a cohesive vision or strategy to execution.
- vi. Overdependence on Government of India Plan Grants.
- vii. Existing stewardship realities leading to constant negotiations / mediations, hindering development of a shared plan for the city.

¹⁵⁸ TDC Annual Development Plan, 2014-2015, 8.

¹⁵⁹ TDC Annual Development Plan, 2014-2015, *passim*.

3. Review of Zone Level Development

The ADP-2013 provides the status of relevant works in the Green Belt and in the four zones, where the absence of systematic plans has resulted in ad hoc development. We briefly review each of these.

Green Belt: The 2011 TDC commissioned Stein and Stein Green Belt Development Plan is yet to be formalized, with the TDC listing limited ‘implementation and enforcement of its prescriptions’ as an issue.¹⁶⁰ This has since been supplemented by the 2019 Green Belt Growth Management Framework Study – also yet to be incorporated in planning decisions.¹⁶¹

International Zone: For this least developed of the four zones, the Zonal Plan approved by L’Avenir in 2009 – which had built on Anger’s continental clustering – was still pending implementation. Other unexecuted works included accommodating village development on lands not belonging to Auroville, archaeological finds in the area and water recharge points. On the integration of Bharatipuram, it was suggested that a ‘long-term process of social engineering needs to be prepared for a model housing project outside the city area that could be more attractive for the people presently living in Bharatipuram, thus making the space for the development of the International Zone.’¹⁶² On the water recharge issues, various reports, including the 2013 Water Sourcing Study by the Centre for Scientific Research, were commissioned.¹⁶³ The archaeological issue was considered in the 2014 Land Suitability Use and Land Use Proposal, which offered a helpful pathway to conduct time-bound excavation and allow for subsequent building activity.¹⁶⁴ It also suggested ways to translate findings from this exercise into a centre for archaeological research that could be tied into a tertiary university framework. The proposal notes:

In principle, once the excavations have been carried out and documented, most of these places could be available for any landscaping and/or building activity ... The excavations and findings thereof provide an excellent opportunity for learning, exchange programmes, educational and research activities for Auroville and village schools, as well as universities offering history and archaeology in their curriculum.¹⁶⁵

¹⁶⁰ TDC Annual Development Plan, 2014-2015, 17; Stein and Stein, 2013.

¹⁶¹ Evangelista et. al., 2018.

¹⁶² TDC Annual Development Plan, 2014-2015, 7. This reiterates a suggestion made by the Planning Group back in 2006: ‘Integrate the village of Kottakarai and Bharathipuram into the industrial zone with mixed land use to provide economic opportunities. Edayanchavady /Bharathipuram to have a green edge to the city to prevent slum-city edge from developing.’ Planning Group, 2006, 10.

¹⁶³ Surface Water Sourcing Study for Auroville City Area: A Study Exploring a Multi-Sourcing Approach for Auroville with the Integration of Matrimandir Lake, 2013.

¹⁶⁴ Land Suitability and Land Use Proposal, 2014, 17. This issue was also studied previously in 2011. The TDC’s Report to the Governing Board notes that a meeting with Prof. Vasavada of the Centre of Environmental Planning and Technology and ‘members of the archaeological team, the Working Committee and SAIER’ took place ‘in relation to identifying a process for Auroville in relation to local heritage preservation and development.’ The Report notes that a ‘road map has been identified in order to harmonize the different requirements of development and heritage preservation.’ We were unable to locate this road-map, or if any subsequent action was taken. See, TDC L’Avenir Report to the Governing Board, 2012, 10.

¹⁶⁵ Land Suitability and Land Use Proposal, 2014, 17.

We may note here that development of the International Zone issue was considered subsequently in detail in 2018, in the TDC commissioned strategic development plan by Mr. Andrea.¹⁶⁶ The IZ Strategic Plan built on proposals in the ADP-2013, which indicates limited to no movement since, seemingly due to internal disagreements and polarization within the TDC at the time.¹⁶⁷ The IZ Strategic Plan provides detailed placements for proposed buildings, roads (including the ‘loop road’, the Crown, service roads and village connections, new roads for construction movement and transport nodes) and parks (along the existing water systems and canyons), alongside proposals for the placement of electrical and water infrastructure, with action points for data collecting and mapping.¹⁶⁸ These are all overlaid on the Galaxy plan to accommodate ground realities (as with the 2014 Land Suitability Study) with participatory development suggestions. In this, it incorporates the clusters proposed by Anger / Jacqline, namely Africa, America, Asia (Central), Asia (North-East), Asia (South-East), Europe, India, Middle East and Oceania, the precise placement of which *inter se* and as against ground realities has been a historical concern delaying effective execution. Importantly, to translate the ideal of human unity into architectural terms, the plan also considers design guidelines for national pavilions to develop a common architectural language with urban parameters identified.¹⁶⁹ We address the placement of the International Zone in relation to Auroville’s ideal research infrastructure in Section III.E, and governance reform in relation to these concerns in Part IV. In interviews, five reasons for this delay emerged: (i) an inability to agree internally on locations for clusters and / or pavilions, absent which an approach to embassies / government / international cultural organizations is limited; (ii) an unclear division of mandates between the IZ Group and the TDC, leading to difficulty in approving project plans; (iii) lack of cohesion amongst the national groups, and a waning of interest / willingness to develop the Zone as new residents are usually inclined to leave behind local and national identities for a more cosmopolitan one, which makes the development of the pavilions / showcasing the genius of each culture a relative non-priority; (iv) lack of funding; and (v) weak coordination between the International Zone Group and national groups as well as between the Town Development Council and the Working Committee, making it difficult to conduct outreach / collaboration with embassies / national governments.

Cultural Zone: The zonal plan for the Cultural Zone, the initial version of which was prepared by Anger in 1995 but not referenced in the Masterplan, was still to be finalized at the time of the TDC Annual Development Plan, 2014-15.¹⁷⁰ As we discuss in Part III.E, there is a need to

¹⁶⁶ See, IZa, 2018; IZb, 2018; IZc, 2018; IZd, 2018.

¹⁶⁷ See, News and Notes, March 2019.

¹⁶⁸ It is interesting to note that this task was anticipated to be done in 1965 by Anger, when he asked Mother to ‘[define] the number of international pavilions and those of the Indian States, because it is necessary to know exactly their number to be able to trace the roads and connections with the rest of the town.’ Mother replied that ‘data [is] to be obtained from Nava [Navajata].’ Anger, 1965, 14.

¹⁶⁹ This included layers of priority, technical suggestions to be NZEB compliant, identification of common facilities (welcome hub, cinema, music hall / theatre, library, art gallery, café, international restaurant representing various cuisines, meditation hall, office and study / research facilities, hostel for visiting researchers and students, languages lab etc). These are in line with Mother’s suggestions for the Zone outlined in Part I.B.

¹⁷⁰ TDC Annual Development Plan, 2014-2015, 17-8.

integrate the educational and cultural projects built since to allow for cluster dynamics and cohesion to emerge.

Industrial Zone: Worryingly, no zonal plan seems to have been prepared for this zone, with the exception of Dhanya's early work.¹⁷¹ The primary concern here has been the lack of adequate capital for reinvestment and growth, absence of basic trunk infrastructure (water connection and electricity) to allow for industrial activity, and the non-priority to develop the commercial sector.¹⁷² We consider this further in Section III.F.

Residential Zone: A draft development plan for Sectors 1 and 2 with a population of 5,000 was prepared in 2010-12, though again not finalized or implemented owing to persistent concerns over integration of the urban design with geomorphological realities,¹⁷³ alongside a resistance to increased densities. These concerns were subsequently addressed in a detailed plan prepared by Feduchi in 2014, which also incorporated the suggestions of the 2014 Land Suitability and Land Use Proposal and the 2013 Water Sourcing Study, while attempting to translate the urban form in Anger's 1970 Auroville, *Study of the Town Plan – First Approach*. We review Feduchi's work in Part III.D, but insofar as the planning trajectory is concern, housing developing the zone remained unsystematic and piecemeal.¹⁷⁴ This continuing concern with unsystematic development – fore-fronted in the Masterplan and its Directions for Growth more than decade earlier – was visually represented in the IDPP.

¹⁷¹ Dhanya, 1987; Dhanya, 1999. Given our constraints, it is likely that we have missed some sources in this respect.

¹⁷² TDC Annual Development Plan, 2014-2015, 18.

¹⁷³ TDC Annual Development Plan, 2014-2015, 18.

¹⁷⁴ See, for a review of housing development at the time, TDC Report to the Governing Board, 2012, 2-5.

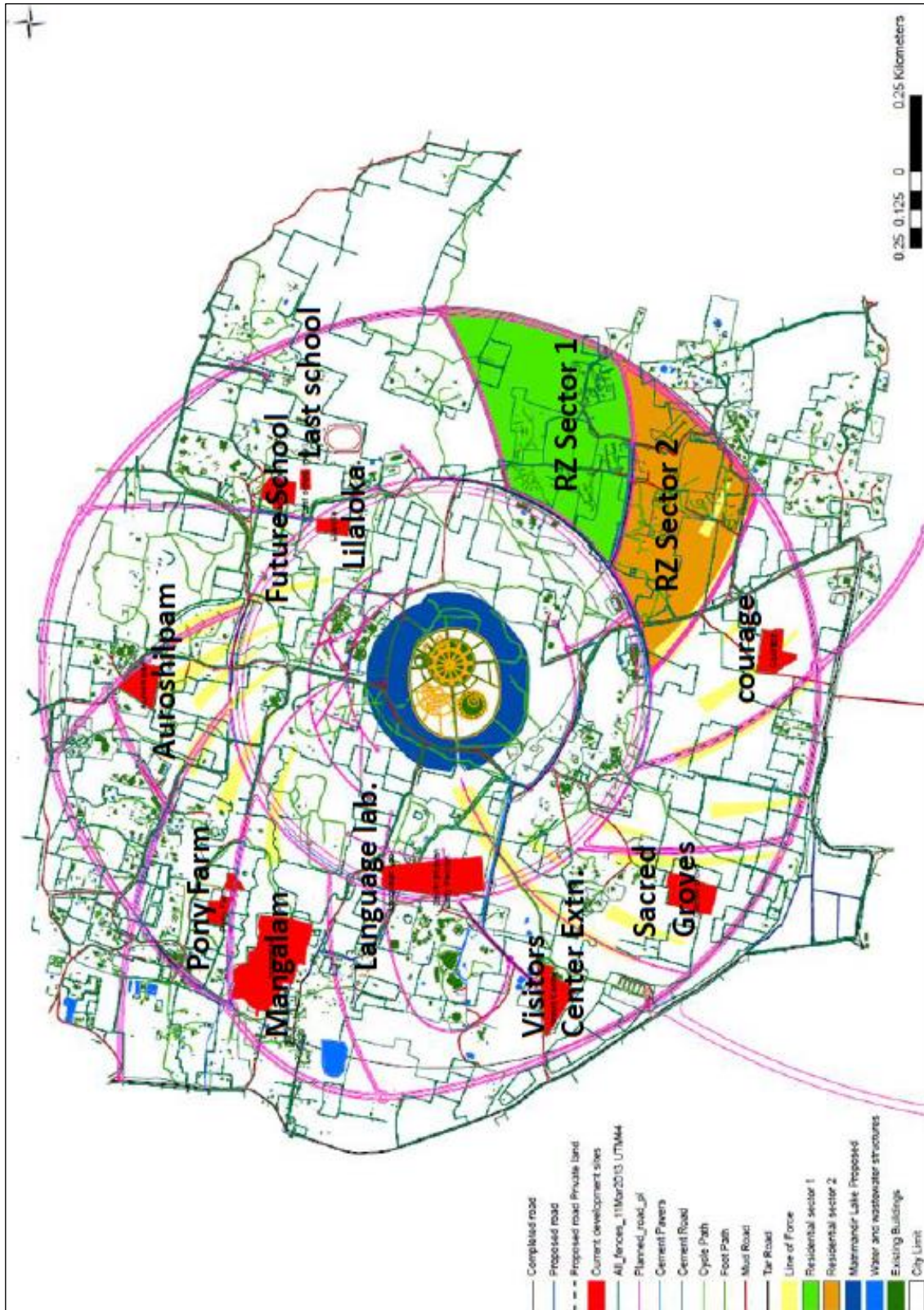

(Ongoing development, 2013. Source: TDC, ADP-2013, 2013, 22)

4. Proposed Development Strategy

Informed by findings from prior studies, the ADP-2013 proposed the following development strategy:

- i. A more compact residential settlement for ‘reducing long distance mobility and promoting stronger social interaction’, as 25% of the population of 2,500 still resided outside the plan area, leading to an urban sprawl and its attendant problems.¹⁷⁵ The core concern is consolidating the habitat area of the city centre. We may note here that this ‘objective ... to increase Auroville’s population concentration in the residential zone from the existing 23% to 50% by 2013’, was proposed four years earlier in the 2009-10 Annual Report, without follow-up action.¹⁷⁶
- ii. A sustainable rate of population growth, with investment and incubation for new enterprises through the development of clusters in the Industrial Zone.¹⁷⁷
- iii. Develop the mobility networks (Crown Road and the Radials in particular), with development of infrastructure along those corridors.¹⁷⁸
- iv. Expand the Auroville Mini Grid.¹⁷⁹
- v. Develop a small-scale industrial park with a training campus in Mangalam, an integrated economic zone with housing and low-cost transition units in Pony Farm and a densification of the Auroshilpam clusters.¹⁸⁰
- vi. Identification of pavilion and cluster locations under Anger’s 1995 International Zone Plan.¹⁸¹
- vii. Finalization of the Stein and Stein Green Belt Development Plan, 2013.¹⁸²

Owing to the ‘development blockages’ identified above, the proposed development strategy did not translate. The TDC’s Report of January to May, 2015, a good summation of issues in general, records some worrying findings a year into the plan:

- i. Feduchi’s plan for the Residential Zone was blocked by challenges in ‘integration of the urban design with geo-morphological realities.’¹⁸³ This document was made ‘available for perusal and ... announced in the N&N [News and Notes] as well as

¹⁷⁵ TDC Annual Development Plan, 2014-15, 20.

¹⁷⁶ TDC Annual Development Plan, 2014-15, 23; Auroville Foundation Annual Report, 2009-2010, 14.

¹⁷⁷ TDC Annual Development Plan, 2014-15, 10.

¹⁷⁸ TDC Annual Development Plan, 2014-15, 20, 42.

¹⁷⁹ TDC Annual Development Plan, 2014-15, 20.

¹⁸⁰ TDC Annual Development Plan, 2014-15, 30.

¹⁸¹ TDC Annual Development Plan, 2014-15, 17-8.

¹⁸² TDC Annual Development Plan, 2014-15, 17.

¹⁸³ TDC Annual Development Plan, 2014-15, 18; *see*, TDC, Report for January to May, 2015, 13.

Auronet ... [and] an open desk has been organized to gather written feedback for a period of 3-4 months', yet the issues were not resolved in the community.¹⁸⁴ Awaiting consensus, the plan subsided. Worrying, the TDC noted at that time that 'there is no fixed urban design for the city yet', but the problem of housing shortage 'prevented the freezing of all building projects (despite no urban design)'.¹⁸⁵ As a result, the explicit policy seems to be for *ad hoc* housing development absent a vision or design / building guidelines. If the Galaxy is to be manifested, this naturally increases the risk of disagreements later, as developments will inevitably need to be altered or relocated to suit the urban design.

- ii. The Industrial Zone plans were hindered by a 'lack of investment and proposal for starting new business initiatives in Auroville and lack of funds for investing in infrastructure especially water connection and electricity.'¹⁸⁶ The Pony Farm and Managalam projects were discussed at a Residents' Assembly General Meeting on 7th April, 2015 – tracing the established lines of debate, the Residents' Assembly Service informed the TDC in a preparatory meeting that participation of residents in planning efforts is important: if plans 'were effectively communicated to the community and the community meaningfully engaged in input into the planning of those projects ... [it] could streamline the execution of new public works in Auroville.'¹⁸⁷ For its part, the TDC noted that for discussions to be meaningful, they must result in action: it 'highlighted that the GM should lead to the end of discussions (as there are many other projects to tackle) and to a decision of implementation (as is emphasized in the GB meeting minutes). Care must be given, but projects need to move forward.'¹⁸⁸ For the radial in the Industrial Zone, six options were 'studied and shown to the community several times' to find a solution 'most adapted to ground realities and [which] represents the least damage to humans and nature.'¹⁸⁹ No agreement was reached or implementation undertaken, with the TDC noting that 'this project has reached a point where certain aspects can be discussed; others are/have become superfluous.'¹⁹⁰ In the General Meeting a week later, residents of Pony Farm felt that the procedure of the TDC was 'invasive and threatening, void of respect and response to feedback.'¹⁹¹ The residents noted that a 12 metre Radial would 'destroy the eco-system of the area' with 15 trees cut, 'split

¹⁸⁴ TDC, Report for January to May, 2015, 4.

¹⁸⁵ TDC, Report for January to May, 2015, 11.

¹⁸⁶ TDC Annual Development Plan, 2014-15, 18. We may note that funding to the tune of Rs. 4 crores came to the TDC in this year from Government Plan Grants. In general, the TDC has received Rs. 3-6 crores a year from external donors, predominantly the Government of India, with a substantial drop from 2017-18. While a thorough impact and utilization analysis of incoming funding (Government Plan Grants or otherwise) is required (a point we suggest in our recommendations below), the trend (at the time, less so recently due to limited funding) of not being able to translate funding into actionable projects reflects on Auroville's institutional integrity and does not bode well for future funding-raising potential.

¹⁸⁷ TDC Report for January to May, 2015, 16.

¹⁸⁸ TDC Report for January to May, 2015, 16.

¹⁸⁹ TDC Report for January to May, 2015, 16.

¹⁹⁰ TDC Report for January to May, 2015, 16.

¹⁹¹ TDC Report for January to May, 2015, 17.

the community into 2' and lead to 'price escalation' in the area.¹⁹² As a result, they called for a new Masterplan and urged that 'all decisions should originate [not from the TDC but] from the RA [Residents' Assembly], taking into account the whole community.'¹⁹³ Each of these concerns were then discussed in detail. The TDC noted that the existing access road ('the temple road') was not suitable for access to Mangalam, such that a Radial was required; using the temple road would further exacerbate mobility concerns by inviting external traffic into Auroville; on the cutting of fifteen trees, it was noted that they 'are not impacted by the road and are not that rare, [such that] their seeds can easily be found' and that 'we are trying to develop a city, not a forest'; the proposal Radial follows the ridge, can 'protect the canyon (unlike the existing road)' and the 'fact that it corresponds to the Galaxy is a coincidence'.¹⁹⁴ These points were not resolved at this meeting, or subsequently, with the impasse on the Pony Farm and Managalam projects, including the Radial, continuing. The discussions appear to be had outside the study material generated on the issue, with no clear mechanism for decision-making at the end of the discussions given the disagreement. The call to amend the Masterplan here is unclear, as the issues in question are left open by the document itself.

- iii. As with a consistent refrain in the records, expert proposals for action ran into participatory roadblocks with a 'resistance when it was time for implementation', and 'petitions signed in spite of/due to lack of information or misinformation'.¹⁹⁵ In some cases, this resistance was explicit, 'where the (Aurovilian) stewards refused and physically blocked surveys.'¹⁹⁶ The TDC accordingly noted that 'parameters need to be defined so that implementation can through with the commitment of the whole community.'¹⁹⁷ As a result, the TDC noted that 'all global town development processes have been stopped'. Interestingly, despite these public concerns with collective projects to develop the urban infrastructure, the TDC noted that 'individual and unapproved projects', proceeding outside any policy framework, 'just go through without anyone saying anything, although advice against these constructions was given based on the public knowledge that there would be future developments in the area.'¹⁹⁸ A week later, the TDC 'expressed their disappointment regarding a clearly visible flaw [in the Pony Farm issue]: people did not respect the process to request building permissions ... but then call on official processes (GM, RAS, etc.) when they need it.'¹⁹⁹

¹⁹² TDC Report for January to May, 2015, 17.

¹⁹³ TDC Report for January to May, 2015, 17.

¹⁹⁴ TDC Report for January to May, 2015, 17-8.

¹⁹⁵ TDC Report for January to May, 2015, 5.

¹⁹⁶ TDC Report for January to May, 2015, 5. The Report notes that 'an email was sent to several working groups, such as the FAMC, the WC and the Governing Board (GB), to inform them of the situation.' No enforcement action seems to have resulted.

¹⁹⁷ TDC Report for January to May, 2015, 18.

¹⁹⁸ TDC Report for January to May, 2015, 16.

¹⁹⁹ TDC Report for January to May, 2015, 18.

- iv. In April 2015, a ‘mobility report of the technical team’ was received by the TDC, which was ‘being studied’ as of May, with remarks made by Schmidt at the time indicating that people’s ‘awareness’ still had to ‘dawn’ to ‘shift points of view in the future, leading eventually to re-studying mobility in the city.’²⁰⁰ As we discuss below, no work was registered on this front till the impetus of the Governing Board in 2022.

- v. On the mini grid, an Electricity Masterplan for Auroville was prepared in July, 2014 by Development Consultants Private Limited.²⁰¹ The Residents’ Assembly service noted in its meeting with the TDC that the plan was ‘very bulky and extremely technical, the community at large would need someone to explain and summarize these documents.’²⁰² Accordingly, it proposed a ‘Communications Coordinator’ to conduct this task. It is unclear if the Electricity Masterplan was discussed subsequently in the community. As we discuss in Part IV, the benefits and nature of community participation in decisions concerning technical matters requires careful examination for future governance choices for both efficiency and moral reasons. Energy planning is outside the scope of our study, yet we may note here that further detailing on the Mini Grid was conducted in 2021 and 2023 – since endorsed by the Ministry of Power, Government of India and SMARTEC – with pathways to target a 100% renewable and zero-carbon energy for Auroville by 2025.²⁰³ These are important movements that merit appreciation and concerted policy planning to build on the substantial work already done to actualize distributed and connected renewable energy generation and storage systems for a sustainable energy future.

None of the matters discussed at the General Meeting – indeed many having been discussed previously at various points in the community – proceeded to a resolution. Eight issues emerge from the failed implementation of the TDC Annual Development Plan, 2014-15, despite the TDC’s best efforts that year with a raft of planning work and series of community dialogues, that inform our analysis for governance reforms in Part IV:

- i. Unstructured, prolonged and repetitive discussions following the democratic demand for participation, without clear mechanisms and as it appears in some cases, intention, to decide and implement. This was so both at the legislative and executive levels, and led to inordinate delays and in some cases, filibustering.

- ii. A selective utilization of collective mechanisms of the Residents’ Assembly.

- iii. Relatively uninformed and selective participation, with expert proposals, studies and technical inputs having an insufficient bearing on the discussion.

²⁰⁰ TDC Report for January to May, 2015, 10, 12,

²⁰¹ Electricity Masterplan for Auroville (Draft), 2014.

²⁰² TDC Report for January to May, 2015, 5.

²⁰³ Van Megan, 2021; Van Megan, 2023.

- iv. Weak centralization and executive authority to implement, with no defined enforcement powers.
- v. A conflation of the executive and legislative domains, with calls for all operational and technical matters to be placed before the Residents' Assembly.
- vi. Unsystematic development, with a resistance to planned processes and lack of awareness of the contents of the Masterplan document itself.
- vii. A lack of trust between the TDC and the community.²⁰⁴
- viii. A persistent gridlock between the ecological and urban imperatives.

Given this slow movement, indeed an active resistance, to the proposals in the TDC Annual Development Plan, 2014-15, the Governing Board pushed for implementation in 15:

The Board recommended that the Town Development Council should be strengthened, particularly in areas of implementation of the planned development and faster execution of infrastructure works.²⁰⁵

This came alongside the Governing Board's institution of a Vision Task Force in 2013-2014 to 're-ignite the spirit' in the community:

The Vision Task Force had been set up by the Governing Board in June 2013 to interact with the Auroville residents and various working groups of Auroville on the major challenges and obstacles faced by Auroville in maintaining a course towards manifesting the ideals of Auroville and to suggest ways in which the residents could re-ignite the spirit, and harness the energy of Auroville.²⁰⁶

Similarly, the International Advisory Council, in its 26th Meeting in 2014, expressed its concerns:

We recognized a number of achievements by Auroville at a time when a number of problems are reaching a crucial stage.

We're encouraged that Auroville is using important tools and strategies in group facilitation, mediation and group process to further shared goals and values. Critical leadership and internal processes in the community must be resolved.

We feel the following to be critical areas ... Management processes and decision-making structures within Auroville.²⁰⁷

No discernible impact of these suggestions is seen in the records since. The pressure for change, it appears, was building up at this point, yet entrenched governance concerns persisted. As a result, the nature of developments across zones continued to remain *ad hoc*, with lack of a cohesive urban vision across the four zones, planned execution of works or necessary capital

²⁰⁴ It appears that the Residents' Assembly Service was informally mediating between the two at this point, though this function does not, and with good reason, find mention in its 2007 mandate.

²⁰⁵ Annual Report, 2014-15, 9.

²⁰⁶ Full Report, Auroville Retreat, 2015, 3.

²⁰⁷ Minutes of 26th Meeting of the International Advisory Council, Auroville Foundation, 2014, 1.

investment in housing and the economy required to address the underlying concern of cyclical stagnation.

e. Governance Concerns (2001-2015)

Despite a series of draft plans and studies with varied planning approaches and orientations, the drafting of an integrated five-year DDP to execute Mother's vision as reflected in the Galaxy concept and the Masterplan remained unrealized, thus placing the planning and development of Auroville in limbo. Summing up this overview from 2000-2015, the following trends emerge in this period insofar as governance is concerned:

- i. Gradual downscaling of ambition:* There is a marked, and worrying, reduction in ambition across proposals, from the 2003 Directions of Growth Report to the ADP-2013, ISP 2013, Land Suitability and Land Use Proposal, 2014 and IDPP, 2014. This gradual adjustment reflects the continuing inaction on planning strategies and phased growth targets.
- ii. Low rates of community participation, and a waning of collective efforts to build the city:* The demand for community participation is valid; yet, after several years of intense studies and reports, presented or co-produced with the community, the absence of an action plan offers cause for serious reflection. Dialogue and deliberation must be robust, but geared towards time-bound implementation, absent which centralizing correctives are required. The trade-off between the twin demands of participation and efficiency discussed with reference to Sri Aurobindo in Part I seem heavily skewed. Our, albeit limited, interactions indicated limited awareness of these proposals, or, in cases where the proposals had been considered, a general (and misplaced) reluctance to planning. There was a preference for each project, unit, group, sector or sub-zone to develop entirely on its own terms with limited, need-based and transactional, negotiation with the Working Groups, leading to *ad hoc* developments with attitudes ranging from indifferent to active resistance to cohesive planning. The need for consolidation accordingly presents itself as a key challenge.
- iii. Absence of executive authority and accountability mechanisms:* Lack of clarity on the executive or implementing authority of the TDC vis-à-vis the Residents' Assembly, Zonal Groups and the community at large, led to the uncertainty and inaction. The complaint of members of Working Groups at the time was reluctance in the community, or at least, in influential quarters, and the complaint of members of the community was the perceived opacity of Working Groups. Given this ambiguous relationship, there is a marked lack of accountability on all sides, which results in – an at time legitimate and at others convenient – deflection of responsibility on other actors.
- iv. Repeated cycling of proposals / discussion points:* There is repetition of issues discussed since 2001, with several overlapping studies and cyclical rhetoric in the

community dialogue, without concrete steps to resolve them. In many cases, absent archival practices and weak institutional memory, residents were unaware of previous work on an issue, which led to the recycling of several well-rehearsed debates and policy proposals.

- v. *Inability to translate external funding and goodwill into action:* While funding – both in terms of external resource mobilization and internal strengthening – was a general concern that dented aspirations at the time, the substantial funding from the Governing of India Plan Grants and other sources, and goodwill of external experts, did not translate into actionable plans. As such, this seems to have dented Auroville’s reputational integrity for future fund-raising.

In sum, these concerns indicate lack of a collective aspiration to finalize plans and/or the institutional discipline to execute them once prepared. If the planning approach in the Ford Foundation letter is to serve as a benchmark, most planning goals identified in 1968 were yet to be articulated by 2015, and indeed, the systems engineering approach that requires close and quick collaboration between sub-systems, was markedly missing in this period. As we discuss in Part IV, the decentralizing impulse risks dissipation and disorder if improperly managed, as seems to be the case in our overview. As a matter of governance reform, this requires a firm institutional corrective.

viii. Vision Realignment, 2015-2019

Given persistent concerns over the implementation of the Masterplan and in particular, the inability to secure a DDP, records since 2015 exhibit a focus to realign Auroville to its founding vision, with governance tensions in the collective rising to the fore. We provide a representative overview of developments in the period between 2015 and 2019.

a. Auroville Retreat, 2015

With the upcoming 50th anniversary of Auroville in 2018, a need to re-energize city-building efforts was expressed by the Governing Board and the International Advisory Council at this time. At their suggestion, a two-day Retreat was organized in March 2015, which brought together 300 residents along with members of the Governing Board and the International Advisory Council over a two-month preparatory and research phase. This was a significant moment in Auroville governance trajectory, as the first instance when members of all statutory bodies came together under one roof. Alongside, given the lack of coordination amongst various bodies – a development blockage identified in ADP-2013 – the Governing Board constituted a Vision Task Force to steer overall city development works.

1. The Motivation

Unlike prior technical and expert-driven studies, the Retreat acknowledged the need to address the gap between planning efforts and the reality of Auroville’s slow and unsystematic development over the years. The objectives of the Retreat were stated as follows:

... to reconnect and engage with the Auroville vision and its manifestation; to reflect on Mother’s vision for Auroville; to introspect and reflect on the spiritual growth of

individuals and the collective; to reflect on the present realities of Auroville; and to envision where Auroville wants to be on its 50th anniversary (in 2018) and in 10 years.²⁰⁸

The aim was to go ‘beyond the collection of empirical facts (as in the previous studies produced) and emphasize the idea that a collective understanding needed to be jointly created.’²⁰⁹ In other words, the shift was from technical considerations to inner ones – this is unsurprising given the raft of planning work since 2001 that did not yield any clear pathways for action.

The International Advisory Council articulated the concerns to be addressed in the Retreat in its 26th Meeting, in a detailed document worth quoting at length for its assessment of governance concerns in Auroville:

In recent years various boundaries of responsibilities and decision making processes have become slightly blurred creating a sense of confusion and generating the need to refresh the commitment to Mother’s vision and to clarify some of the processes for communication and decision making. It might, therefore, be helpful to bring all the key stakeholders together through a short Retreat planned collectively with facilitation from an experienced and professional external facilitator.

This would provide an opportunity to reflect and review some of the working principles and processes with particular regard to management and decision making structures. This introspection would help Auroville to recognize its considerable achievements and learn from them in order to plan for the next stage in its development. This is a particularly opportune time to undertake this exercise because of the challenges Auroville is facing. There are certain interrelated crucial factors affecting the further evolution of Auroville as a unique model of human endeavour within a sustainable, spiritual and collective framework.

These factors include the: Population and resident projection deficit. Land related matters. Spreading and widening of the message and the mission. Sharing and showcasing the unique achievements of Auroville with the wider global community ... creating more open, effective and cohesive channels of internal and external communication.

Objective of the Retreat [were this defined as:] Revisit and reinvigorate the commitment to Auroville’s vision. Examine Auroville’s current ways of operation, their strengths and the areas in need of revision. Consider its current management/decision making structure, and [plan] an integrated approach to widening and projecting Auroville’s unique contribution both within and without ...²¹⁰

Having identified its concerns, the Council proposed a way forward:

²⁰⁸ Full Report, Auroville Retreat, 2015, 2.

²⁰⁹ Full Report, Auroville Retreat, 2015, 3.

²¹⁰ Minutes of 26th Meeting of the International Advisory Council, Auroville Foundation, 2014, 1-3.

The Retreat should come up with the planning for how to respond to the issues in a collective, systematic and planned way including a clear sense of timeline, responsibilities and accountabilities

[The outcomes of the retreat were identified as follows:] No group or individual feels they have not been heard. If the retreat succeeds in converging ideas and creating a collective and cohesive approach, it will provide a truly sound basis for further progress towards achieving the Mother's dream.

[Further actions were identified as follows]: We suggest the following steps would help the logistics of the retreat: An external facilitator/organization needs to be identified and briefed. The Vision Task Force should undertake to liaise with the Resident Assembly and the Working Committee and act on their behalf as the internal planning group to plan the Retreat along with the external facilitator. The Vision Task Force should also undertake, with the support and involvement of the Resident Assembly and the Working Committee, to establish a process of consultation within Auroville to inform and involve various stakeholders.²¹¹

Accordingly, a wide community participation framework facilitated by Aromar Revi, Director of the Indian Institute of Human Settlements and previously a member of the TAG, was instituted in collaboration with the Vision Task Force, Working Committee and the Residents' Assembly Service. While we discuss several findings of the Full Report of the Retreat in various parts of the study as and where relevant, it is important to briefly reflect here on the process of deliberations followed, its core substantive conclusion and the post-retreat mechanisms meant to 're-ignite' and 'harness' the scattered energies in the three-year timescale. The first of these is especially important, given common complaints in the records of the time with 'top-down' governance, i.e., the perceived imperviousness of Working Groups to the community.

2. Process of Deliberation

The Retreat was a notable gathering of close to 300 residents over 35 thematic sessions, with an open invitation to the community to participate both in the preparatory phase and the two-day conference.²¹² The chart below is a schematic representation of the preparatory phase:

²¹¹ Minutes of 26th Meeting of the International Advisory Council, Auroville Foundation, 2014, 3-6.

²¹² Full Report, Auroville Retreat, 2015, 4-10.

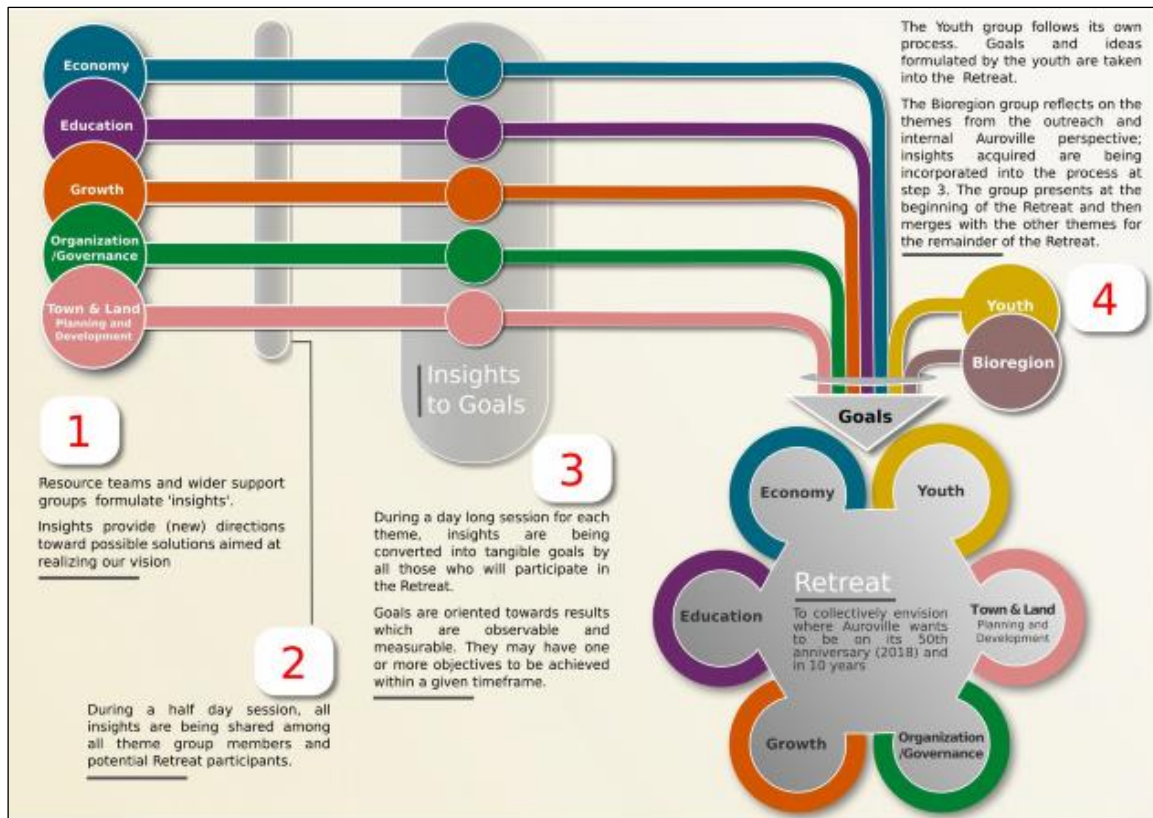

(Source: Full Report, Auroville Retreat, 2015, 4)

The areas focused upon were governance, land and planning, population growth, education, economy, bioregion, and youth development. For each of these themes, a resource group of 9-12 residents was asked to map the existing ground realities and challenges, with a virtual support group set up with 'web-based tools that allowed all Auroville residents to provide inputs to any one or more of the Retreat themes.'²¹³ Based on this consultation, each group produced 15-20 insights, which were discussed at a half-day meeting to 'further harvest the input of the wider community.'²¹⁴ Mindful of the International Advisory Council's cautionary note that no resident should feel left out, the Retreat report notes:

The organizers understood that these groups could not represent all viewpoints and perspectives present in the community. Yet, the group size and composition was felt to be sufficient to give a cross-sectional view of general understandings and trends. Nonetheless, to widen the circle and complement the work done by the resource groups, a second/parallel process was implemented, giving the community as a whole an opportunity to participate by way of web-based tools. Community members were asked to sign-up for one or more themes, thus forming support groups for each resource team. To maintain a closed communication loop, this larger support group received all notes produced and all material shared during the resource group meetings and were also asked to respond to questions similar to the questions that were posed to the resource groups. Conversely, the resource groups were able to access input and feedback from the respective support groups.²¹⁵

²¹³ Full Report, Auroville Retreat, 2015, 5.

²¹⁴ Full Report, Auroville Retreat, 2015, 5.

²¹⁵ Full Report, Auroville Retreat, 2015, 6.

In this, to allow for sufficient dialogue,

it was deemed necessary to lay a foundation which is rooted in collectively formulated value and vision statements and provides space for the participants to step out of their normal frame of reference and deep-seated ways of thought, thus allowing alternative and unexpected viewpoints to enter. Therefore, a total of four half-day sessions over four successive weeks were scheduled.²¹⁶

A range of facilitative frameworks were thus used to harness views and allow for common action strategies to emerge. Finally, to translate this resource-group-led participatory process into ‘into concrete, achievable goals’, a full-day session for each theme was organized.²¹⁷ To translate, as one of the authors of the ISP noted, the ‘fun process’ of ideating to implementable solutions, the Retreat noted:

The identified goals with their milestones differ from insights in that they detail purpose and scope of desired outcomes and are oriented toward results which are observable, measurable and achievable within a given time-frame.²¹⁸

In terms of the substantive conclusions of the Retreat, each theme group provided action points with defined timetables (ranging from one to five years) for relevant Working Groups to follow up. In relation to town planning and development, the Report echoes – almost identically – concerns raised in reports over the previous decade (as indeed those since, including in May 2023 during our research). We quote relevant excerpts at length:

Insights:

1. The planning and development of Auroville as a city and as a society go hand-in-hand. The society of Auroville needs to reflect the values of Auroville.
2. Ad-hoc planning and development related decision-making needs to be replaced with decision-making based on development plans, development criteria, terms of reference and priorities with time lines.
3. Beauty and harmony are essential ingredients of the urban fabric of Auroville.
4. The infrastructure of Auroville needs to be planned and developed in accordance with development priorities while ensuring that long term development goals can also be met. The infrastructure plans need to take into account the concerns of the residents of the bioregion (e.g. bypass roads).
5. Development criteria need to include socio-economic criteria (e.g. the location of income-generating units).
6. Auroville Planning and Development needs to proactively work with response to the surrounding regional development and growth patterns.
7. Detailed Development Plan to be prepared within a time frame.
8. Prepare Agreed Development Priorities and Agenda.
9. Focus on key Galaxy Plan features for the next 5-10 years timeframe.
10. Develop Auroville’s ‘Socio-economic Programme’ as a direct & crucial input for Planning.

²¹⁶ Full Report, Auroville Retreat, 2015, 6.

²¹⁷ Full Report, Auroville Retreat, 2015, 5.

²¹⁸ Full Report, Auroville Retreat, 2015, 9.

11. Housing models to be evolved on the lines of ‘providing and allocating’ rather than a buying and selling system.

12. Development Funding / Financing options need to be worked out that may include loans or a revolving fund so that the upfront financial burden for housing and building construction in general can be dealt with.

Goal 3: Build key elements of the city (e.g. the lake and one or two lines of force)

1. Develop a connection between the galaxy plan and the ground reality
2. Socio-economics: The township must be self-supporting
3. Sustainability is a key element
4. Need to have new ways of funding the development of Auroville
5. For housing focus on residential zones 1 and 2
6. Infrastructure development with a long-term view²¹⁹

The response of the Facilitators to this exercise was as follows, pointing to the need for concrete outcomes, the nub of concerns over the last decade:

1. The Resource Group had identified the urgent need of having plans with reference to which building sites would be allocated and building permissions would be given. This insight has not been translated into a concrete milestone that sets dates for the completion of these plans and a strategy to realise this milestone.
2. The requirement of sustainability needs to be detailed and have clear milestones.
3. The Resource Group had identified the lack of full time human resources that are at work for Town Planning and Development. This insight did not find a place in the output.
4. The Resource Group had identified the lack of financial resources for the planning and development of the town. This insight did not find a place in the output and no strategy has been included that would resolve the lack of human and financial resources.
5. The Resource Group had identified unresolved disagreements about the (concept) design of the town which act as continuous undercurrents in town planning related decision-making. This insight did not get translated into a strategy or milestone.
6. The Resource Group had identified the need of the physical and non-physical (‘society’) development of the town going hand-in-hand. This insight has not been translated into a strategy that would result in such balanced development.
7. Performance indicators are missing.²²⁰

After identifying insights and goals in general terms, the challenge, as the facilitators noted, was to have clear time-defined targets and action-plans to meet these goals. To address this, two milestones with time-targets were identified:

²¹⁹ Full Report, Auroville Retreat, 2015, 21.

²²⁰ Full Report, Auroville Retreat, 2015, 35.

Milestone I:	
Develop a connection between the galaxy plan and ground reality.	
Most critical challenge	Enabling conditions for this to happen
1. Willingness to have a flexible approach from all sides and the various stakeholders.	1. Identify the essential features of the galaxy, categorize the topographical features to be retained.
<u>Suggested Working Groups and People:</u> TDC / Green group / Panel of Planning experts	
<u>Timeline:</u> June 2015	
Milestone II:	
Sustainability framework to be integrated.	
Most critical challenge	Enabling conditions for this to happen
1. Primary resource scarcity (water / energy / trained human resources).	1. Adopt policy of frugality in the resource management planning and maintain forests as much as possible.
<u>Suggested Working Groups and People:</u> External consultants to help benchmark	
<u>Timeline:</u> November 2015	

(Planning and development milestones. *Source:* Full Report, Auroville Retreat, 2015, 51)

Surprisingly, discussions during the Retreat, at least those reproduced in the Full Report, do not refer to the substantial planning works conducted since 2001 – Schmidt-Billinger, Anger’s zonal plans, Directions for Growth report, ISP, IDPP, Land Suitability and Land Use Proposal, ADP-2013, Feduchi’s Draft Detailed Development Plan, the Electrical Plan and others – which considered these issues in detail and proposed strategies for action. This would have allowed for an informed discussion on pathways forward, avoiding the chronic issue of *tabula rasa* discussions at each stage. In any case, the follow-up process of the Retreat was to secure time-bound implementation of these two milestones and others in seven workstreams. By the end of the Retreat, each thematic area group came up with a number of goals that they considered would ‘revivify’ that sector and set it upon a course more closely aligned with the ideals of Auroville. The identified milestones were to be implemented within a maximum of three years by action groups appointed for the purpose.²²¹ The post-retreat processes were identified thus:

²²¹ Full Report, Auroville Retreat, 2015, 3.

Retreat & Post Retreat Processes		
Timeline	Process	Remarks
0	Retreat Define Goals, Milestones & Key actions	
1 - 2 Months	Prepare concrete Strategy (Concept Paper) for each goal (milestone)	Includes People Teams Groups (Accountability) Includes Performance Indicators
2 - 6 Months	Commence actions	Observe & Record
6 Months	1st Evaluation	Report Community Feedback & Support GB - IAC Feedback & Support

Retreat & Post Retreat Processes		
Timeline	Process	Remarks
6 - 7 Months	Revise and Tweak Strategies if needed	
6 - 12 Months	Continuation of Actions	Observe & Record
12 Months	Comprehensive Review	Report & Review of Goals (Milestones) and Directions Community Feedback & Support GB - IAC Feedback & Support
12 - 13 Months	Revise and Tweak Strategies (Define remedial actions where needed)	Consider: Change of People/Teams/Groups Change of Methods/Structures Change of Processes

(Retreat and post retreat processes. *Source*: Full Report, Auroville Retreat, 2015, 69-70)

To further secure community engagement, after the Retreat, the Residents Assembly Team in collaboration with the Action Groups, the Vision Task Force and the Working Committee presented the reports and proposals to the community of Auroville to plan the way forward.²²² As the Governing Board noted:

The Retreat organising team spent considerable time in working with the residents of Auroville in shaping the 7 major themes of the event. The important outcome from the event is that it helped the residents to set goals to be achieved when the township celebrates its 50th year on February 28th 2018.²²³

3. Short Reflections

This robust and detailed process of community engagement, not simply consultations, conducted over a period of two months, was a response to the disengagement with collective fora prevalent at the time. It a calculated attempt to run an inclusive and participatory process. It ought in the ordinary course of matters to have led to a clear vision and strategy for growth. However, despite this effort, the records indicate that these complaints have persisted. It appears that neither the internal processes, nor the feedback / review by the Governing Board and International Advisory Council, came to fruition, raising again concerns with governance forms unable to secure effective implementation despite broad-based participation.

In assessing the Retreat, we may note here an interesting study conducted contemporaneously with the Retreat in September 2015) by the Queen’s University School of Urban Planning and Research in collaboration with the Auroville Integral Sustainability Institute.²²⁴ The study considered global best practices and Auroville’s community dynamics to outline an ‘Auroville Community Participation Framework’, which we extract below.

²²² Auroville Radio, 2015.

²²³ Governing Board, Auroville Foundation, 2015, 9.

²²⁴ Agarwal et. al., 2015-2016.

The following toolkit was developed to guide those wishing to create and implement a community participation plan. Each of the seven steps are explained in detail, highlighting why they are imperative to the overall process and how to carry out the needed requirements for each. The hope is that this toolkit will provide direction for the implementation of successful community participation.



The community participation framework created for Auroville is intended to be a detailed step-by-step process. Each of the seven steps should be completed in the order they appear in this document to allow for the implementation of an intuitive process. It is this report's hope that at each step of the process, community participation organisers discover new and additional information to help the framework grow organically. Figure 4.4 provides a summary of how each stage of the framework works individually and in conjunction with each other.

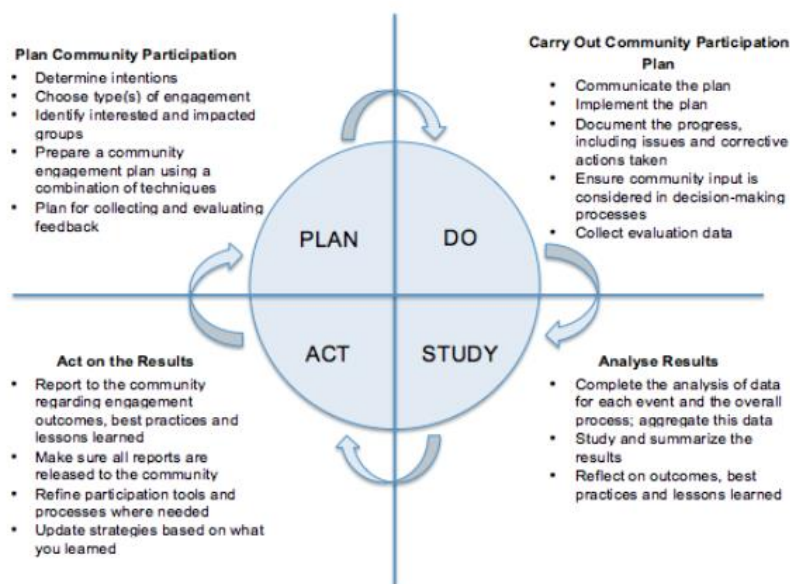

(Left, steps in the community participation framework. Right, summary of the framework.

Source: Agarwal et. al., 2015-2016, 36)

The 2015 Retreat, by these metrics and others generally accepted in inclusive planning literature, was a facilitated participatory planning tool that allowed for diverse engagement, feedback and transparency in the process. Yet, while the ‘study’ was conducted, the ‘action’, ‘planning’ and ‘doing’ lagged, thus vitiating the outcomes generated in the process. As we suggest in Part IV, Auroville may consider time-bound, sub-zonal participatory mechanisms, with defined executive mandates to Working Groups to allow for meaningful, not inflated or unstructured, participation, to resolve disagreements and finally to implement, along the principle of illumined hierarchies discussed in Part I. A mature governance scheme, including one that rightly relies heavily on community-driven processes, mandates effective distribution of governance labour, with defined accountability mechanisms. The planning process describes thus far in our review stands in contrast to this scheme, outlined for example in Mother’s Ford Foundation letter, which lays particular emphasis on quantifiable metrics for measurement within defined times, absent which such processes lack the necessary teeth for city-building.

As with earlier planning work, a participatory community-led process enjoins members of the community to actively participate in such fora, with inputs, suggestions and criticisms, and allow for subsequent implementation by Working Groups with a clear executive mandate on agreed policy outcomes. Absent this governance ethic, if we may call it that, the complaint – voiced in the ADP-2013, the Governing Board’s remark in its 57th meeting and several interviews – of a proliferation of discussion fora with none leading to action, is valid. Community dialogue cannot be an undefined process of conversation, but one directed to agreement on a common action plan within reasonable time-limits. We incorporate this concern in our governance reform proposals in Part IV.

Thus, while the Retreat was successful in laying down the different views held by the community on Auroville’s development, along with suggested – though often vague and unspecified – milestones, absent clear pathways for execution, the momentum generated seems to have dissipated over time. The twin concerns of participation and efficiency seem to tilt heavily in favor of the former.

b. Rejection of the Vastu Shilpa Foundation Proposal

After the Retreat, (i) with the planning strategy of the Masterplan still to be implemented and the proposed timelines delayed by ten years, (ii) with multiple expert-driven studies (both internal and external) unable to garner the necessary community support, (iii) and post-retreat processes not sustained, Mr. Doshi, member of the Governing Board, Chairman of TDC and renowned architect, offered to develop a DDP across zones in November 2015. This resulted in a detailed proposal – starting from a reconnaissance survey and data collection to the preparation of Zonal Plans and Development Control and Urban Design Guidelines – for the work to be completed in nine months at a cost of Rs. 91.3 lakh.²²⁵

Alongside, in October 2015, the Governing Board decided to restructure the TDC and establish a new town planning authority to execute the Masterplan and prepare a DDP.²²⁶ A ‘Selection Committee’ was constituted for this purpose, comprising Mr. Doshi, three Auroville architects

²²⁵ Vastu Shilpa Foundation, 2015.

²²⁶ Auroville Foundation Annual Report, 2015-2015, 6.

and one external architect, to prepare a list of key personnel required for the functioning of the office along with job descriptions. A similar exercise, we may note, was conducted earlier in 2010 by Mr. Dattatri.²²⁷ The Committee's suggestions, however, 'was not taken further by the Selection Committee, a major issue being the difficulty of attracting highly-skilled planners to the relatively remote area where Auroville is located.'²²⁸ This too was made explicit in the 2007 L'Avenir Mandate.²²⁹ Subsequently, the Working Committee, with the concurrence of the Governing Board, presented a proposal to restructure the TDC to the Residents' Assembly on 23rd January 2016.²³⁰ This was a key proposal, with the following recommendations:

- i. Vastu Shilpa Consultants (the architectural firm led by Mr Doshi) will draft the DDP to translate the Galaxy concept within the policy parameters of the Masterplan.
- ii. The community will set up a 12–15 person Client Body comprising qualified Aurovilians working in various fields such as planning, infrastructure, environment, economy, services, education and regional development, to act as 'interface' between the community and Vastu Shilpa Consultants. The terms of office of the Client Body will be formulated by a subgroup to be set up by the Auroville Council (whose task it is to formulate mandates), which will be submitted to the Residents' Assembly for its approval.
- iii. The charges of Vastu Shilpa will be borne from the Plan Grants, thus not affecting Auroville's internal reserves.
- iv. Vastu Shilpa will avoid farming the work out to independent contractors.
- v. The Client Body and Vastu Shilpa will work on initiating a capacity building programme towards instituting an Auroville Technical Planning Office. They will recruit Aurovilians and young people interested in Auroville and in town planning, who can benefit from the expertise of Vastu Shilpa.
- vi. A review of the TDC structure, between the Client / Interface Body and the Technical Team, will be conducted after Vastu Shilpa's work to ensure smooth succession.
- vii. In the meantime, the present TDC will continue to function, but only for the implementation of the annual development programme, approval of development, building permissions, Master Plan Status and protection, regional and village development activities, development budgeting, administration, and interface of the existing technical services (survey, GIS, engineering, etc.).
- viii. Mr. Doshi will resign as a member of the Governing Board and as Chairman of the TDC to avoid a conflict of interest.

However, based on discussions in the Residents' Assembly General Meeting, Dr. Doshi / Vastu Shilpa's proposal was rejected by the Working Committee in a letter dated 25th February 2016:

²²⁷ Dattatri, 2010.

²²⁸ News and Notes, January, 2016.

²²⁹ Mandate for L'Avenir d'Auroville 2007, 3, 5.

²³⁰ Working Committee, 2016.

The community of Auroville, in a general meeting, has discussed the proposal presented by the Working Committee which had been discussed with you.

The community appreciates and values very much the thought and skill put into the proposal by Mr. Doshi and his team and look forward to their continued support.

To take a step forward the community will organize a retreat and supplementary workshops, involving concerned working groups as well as the community at large, to define a planning brief to be taken forward by a client body and / or the new TDC to be reconstituted after the present term expires in October 2016. In this retreat it should also become clear to what extent Auroville has the necessary skills in-house and to what degree the Vastu Shilpa Foundation can help in areas where the required skills are not available. The community would very much appreciate if the team from Vastu Shilpa will participate in this retreat.

In the meantime, pending the outcome of the Retreat, the community requests Dr. Doshi to continue his membership of the Governing Board and his work as Chairman of the TDC.²³¹

Coming on the back of the Working Committee's proposal, the 2015 Auroville Retreat and several internal and expert-led studies and reports since 2003, this stance was surprising for several reasons. First, a review of existing in-house capacities had already been discussed at multiple points in earlier documents, and as such, it is unclear why a further review was required. Second, this letter came after the 2015 Retreat which involved all three statutory bodies, saw wide community participation, and pushed for the time-bound preparation and implementation of the DDP. As such, the issues identified in the letter had already been addressed extensively in the community. Third, Mr. Doshi's proposal was to both involve internal experts and seek public consultations and inputs, thus alleviating concerns on that front. Fourth, the 'in-house' versus external distinction implied in the letter is inapt as Mr. Doshi was a member of the Governing Board and the TDC, aside from his long-time association with Auroville. The importance of welcoming external expertise, particularly where aligned and eminent individuals are concerned, is important to reiterate.²³²

In any case, the actions mentioned in the letter – internal assessments of expertise, or reconstitution of the TDC along the proposed lines – were not carried out before Dr. Doshi's term's as member of the Governing Board came to an end. As such, the proposal lapsed.

c. Restructuring the Town Development Council

The organizational story that emerged so far was as follows: in October 2015, the Governing Board decided to restructure the TDC and prepare a DDP. A 'Selection Committee' was constituted for this purpose, whose suggestions were not taken forward due to internal capacity constraints in key professional disciplines. After Mr. Doshi's proposal to prepare the DDP was

²³¹ Working Committee, 2016.

²³² We discuss the need for an open and assimilative ethic briefly in Part IV.E. As such, the TDC noted in 2015 that it 'regularly receives requests (with CV, portfolio, etc.) from all around the world for work in Town Planning, Architecture, Landscaping, Urban Planning and Urban Design. As the TDC is currently undergoing a restructuring, all requests are put on hold for the moment.' TDC, 2015.

rejected by the Working Committee, it presented a proposal to restructure the TDC to the Residents' Assembly on 23rd January 2016.

1. *Terms of Reference*

The Working Committee's efforts at restructuring the TDC, which ran from 2015-2017, turned out to be inconclusive, with conflicting and parallel processes in play. In May 2016, the Auroville Council and Working Committee noted that, as the restructuring process would take six months, and the TDC had only two people working on a daily basis – a fact that speaks to the governance of the sector –, seven interim members would be appointed through an open call.²³³ While these members were to 'be a mix of part time and full time, representing skills of administration, organisation, management, communication, finance, architecture/ planning and bioregional work', no details of technical expertise or prior qualifications were provided in the call, to the best of our understanding.²³⁴ As such, the basis for the selection of these members was unclear.

Alongside, the Auroville Council continued work on a proposed Terms of Reference ('TOR') document to guide the restructuring of the TDC. The first draft was presented at a Residents' Assembly General Meeting on 16th March 2017 (with 75 residents present, or approximately 3% of the population – consistent with the extremely low participation over the years in town planning matters involving participatory methods), and again on 24th April 2017. A Residents' Assembly Decision incorporating the TOR was adopted at this meeting, with a five-member 'Interface Team' selected in October, 2017, and a 'Technical Team' stated to follow.

The TOR is an important document – it is, to the best of our understanding, the first written and comprehensive set of guidelines for the TDC since the 2007 L'Avenir Mandate, with which it bears much in common. Indeed, it appears that the institutional conversation came full circle. Four points are relevant here:

- i. The TOR represents a clear intention to manifest the Galaxy – with the Matrimandir, its lake and gardens, Crown, City Centre, Lines of Force, roads 'in a radial fashion', and a stipulation of 50% green cover – 'whilst maintaining sufficient flexibility to allow for future re-interpretation as and when the physical or perceptual parameters change'.²³⁵ While the scope of this future 're-interpretation', and of 'perceptual parameters' is not defined, it recognizes that the challenge 'lies in the necessity of needing to define who gets to interpret, define or redefine aspects of the Galaxy concept in the future'.²³⁶ This indeed is where the nub of the problem lies, as our discussion of the historical record above demonstrates. As we note in Part I, while robust community engagement with an aspiration of consensus is necessary, and in line with Auroville's political aspirations read in light of Sri Aurobindo's thought, the principle of illumined hierarchies must dictate final decision-making. A clear

²³³ News and Notes, No. 675, 2016.

²³⁴ News and Notes, No. 675, 2016.

²³⁵ TDC Terms of Reference, 2017, 5. On progress and experiments on the Matrimandir Lake, which has spiritual (as a holding receptacle), aesthetic and environmental aspirations, *see*, Auroville Today, June-July, 2023.

²³⁶ TDC Terms of Reference, 2017, 5.

articulation of this principle in the practical context of the TDC’s functioning is necessary to avoid both minority capture and majority filibustering. Practically, this would require a reconsideration of the popular vote selection criterion currently in place, with final authority resting with the TDC, subject only to the review function of the Unite Committee we propose in Part IV. The TOR hints in this direction, indicating that the Interface Team will ‘stand in’ for the Residents’ Assembly, acting as its delegate, such that it may decide on its behalf – yet this is not made explicit.²³⁷ Equally, the TOR highlights the importance of consultative processes in city-building, with a list of participatory planning tools that may be adopted, incorporating best practices, but does not clarify the precise mechanics. It proposes consultation with ‘different section of the community and the following working groups such as: WC, AVC, FAMC, BCC, ABS, AVAG, Housing Board, SAIIER, Land Board and individuals involved in planning and development (IZG / Industrial Zone / art and cultural / architects’.²³⁸ However, it does not specify the nature of these consultations / joint sittings, distribution of authority or timelines involved. It also does not clarify why Zonal Groups other than the International Zone Group are not included, or why the ward/sector level organization proposed in the Masterplan is not considered. As we propose in Part IV, Auroville may consider defining a clear sub-zonal structure for devolved and clear consultation and decision-making processes, which explicitly assigns responsibility and can thus ensure accountability for delays. The TOR does not define the mechanics for decision-making *once* community input has been solicited and if disagreements persist, the institutional bottleneck. This requires elucidation. We consider this in Part IV.

- ii. The TOR recognizes the need to streamline the functioning of the TDC, with an ‘enhanced empowerment’ to develop and implement the DDP.²³⁹ This implicit recognition of the need for a distinction between executive and legislative functions – though not articulated as such – is the first in the records we have studied. It acknowledges the need for directional, implementation-oriented work, to avoid the ‘interminable talk’ outlined in ADP-2013, the TDC’s 2015 Report and the 2015 Retreat.²⁴⁰ However, this requires further specification to concretize decision-making processes, performance benchmarks, timelines and implementation guidelines. The TOR makes clear that it does not ‘aim to cover ... details on engagement with Auroville residents or detailed functioning of the TDC’.²⁴¹ As a reference document, this is reasonable; however, to make its commitments practical, a clear definition of these details is necessary. As far as we are aware, the TOR was not followed up with a document of this kind. This is urgent and necessary.

²³⁷ TDC Terms of Reference, 2017, 18.

²³⁸ TDC Terms of Reference, 2017, 18.

²³⁹ TDC Terms of Reference, 2017, 5, 19.

²⁴⁰ TDC Annual Development Plan, 2014-15, 11; TDC, Report for January to May, 2015, 16; Full Report, Auroville Retreat, 2015, 34-5, 45 on the need for performance targets.

²⁴¹ TDC Terms of Reference, 2017, 6. It is somewhat worrying that a detailing is still pending.

- iii. The TOR recognizes that the TDC is accountable to both the Governing Board (as per Standing Order 1/2011) and the Residents' Assembly (as per the AVF Act, 1988).²⁴² To this end, it constitutes an Interface Team to allow for resident participation and engagement in urban planning, with the for the majority of the TDC as per the Standing Order through nominations by the Residents' Assembly through its selection guidelines. As we discuss in Part V, there is a necessary ambiguity on this question of reporting in the AVF Act, 1988 – the practice thus has been one of dual accountability through Residents' Assembly-nominated, Governing Board-appointed Working Groups, with day-to-day accountability to the Assembly and periodic review by the Governing Board – a convention practiced with variable and uncertain results in the past – which offers a route to secure the mutuality necessary amongst the statutory bodies.
- iv. Crucially, the TOR created a dual-track structure for the TDC: an interface team meant to be the channel between the planning experts and the community, and a technical team, meant to plan, execute and oversee implementation through external consultants or contractors.²⁴³ The issue, which appeared after the 2011 Standing Order, was whether the TDC was a planning body with internal expertise or a client body representing the residents: as such, between 2011-2017, the operational processes were unclear, as the selection processes in that period indicate. Complaints were registered by professionals that the TDC was attempting to be the former without possessing the necessary expertise, and by the community that it was insufficiently attentive to community participation. The TOR sought to address this elementary problem with distinct work-streams.
- v. The TOR highlights the need for time-bound delivery of plans, though it does not specify a timeline for the DDP.²⁴⁴
- vi. The TOR prioritises the preparation of Zonal DDPs, with a focus on the Industrial Zone, which is based on an 'environmentally and socially responsible interpretation of the Galaxy plan'.²⁴⁵ It mandates the TDC to design and develop social and physical infrastructure, with a renewed focus on regional development, mobility planning and phased population growth targets. The Masterplan, it reiterates, is to serve as a policy document for these matters. As studies from 2003 to 2017 note delays in action, given the inability to reach agreement on plans, lack of urgency to execute works and a dilution of the original vision, the TOR recognizes the need to infuse the necessary urgency to translate commitment into practice.

²⁴² TDC Terms of Reference, 2017, 17.

²⁴³ TDC Terms of Reference, 2017, 18, 20. The 'technical team' is not mentioned by name.

²⁴⁴ TDC Terms of Reference, 2017, 17.

²⁴⁵ TDC Terms of Reference, 2017, 19.

- vii. The TOR recognizes that external expertise is necessary, given internal capacity limitations, with ‘check points’ to ensure quality assurance.²⁴⁶ In this, it again helpfully distinguishes between the Interface Team, meant to link residents to the planners, who constitute the Technical Team. Given a resistance to external input in the preceding decade, culminating in a rejection of Dr. Doshi’s proposal, this is an important shift, though one that has been consistently stated on paper since 2003 yet rarely practiced.
- viii. The TOR emphasizes evaluation and monitoring of the TDC by an independent body to ensure accountability in terms of performance benchmarks. However, it does not specify the composition or mandate of this body – a task that remains unfulfilled.

Thus, the TOR marks a shift towards an urgent, implementation-oriented push to manifest the Galaxy. While there are gaps that require specification to translate its commitments, it represents an advance on the historical record on unsystematic and slow urban planning till 2017.

2. *The Functioning of the TDC post 2017*

Problems with the working of the TDC, however, persisted. In December 2018, a year after it was restructured, five members resigned due to internal disagreements. The Auroville Council and the Working Committee appointed three interim members (again, the basis for the appointment of ‘interim’ members is unclear) to take their place. They also appointed a Study Group to assess the reasons for the resignations, to address accountability concerns (‘why the aims and objectives were not followed as expected when the present team was appointed’) and to address, yet again – for the third time in as many years – the question of (re)structuring the TDC.²⁴⁷

The Study Group reached the following conclusions, reiterating views expressed *ad nauseum* over the past decade: (i) divergent opinions and fractured team dynamics, with personality clashes and differing views on basic principles and priorities; (ii) absence of division of work and responsibilities, leading to accountability concerns; (iii) long absences by some members, and an apparent lack of commitment by others; (iv) lack of competence in the Interface and Technical teams (unsurprising, given the absence of clear qualification requirements in the selection process); (v) lack of funding; (vi) disagreement on the new mandate/ TOR, with ‘little attempt made to follow it’;²⁴⁸ and (viii) lack of proper management, secretarial assistance and other logistical concerns.

Accordingly, the Study Group made several recommendations, all of which are again reflected in the records since 2005.²⁴⁹

²⁴⁶ TDC Terms of Reference, 2017, 20.

²⁴⁷ TDC, Auroville Wiki, 2023.

²⁴⁸ News and Notes, No. 791, 3.

²⁴⁹ News and Notes, No. 791, 3.

- i. An expert-led selection process, with descriptions of professional / technical competences, which are not reflected in the Participatory Working Group Selection Processes.
- ii. Appointing external consultants if internal capacity is weak (as the Governing Board-appointed Selection Committee had suggested, in relation to Vastu Shilpa, reiterating the 2007 L’Avenir mandate).
- iii. Preparation of work plans within three months of appointment (an implicit *sine qua non*, yet made explicit here)
- iv. Defining a process for community consultation (a point considered in some detail in the ISP, 2013, IDPP, 2014, the 2015 Retreat and Mr. Doshi’s proposal).
- v. Transferring decision-making powers from the Interface Team to the Residents’ Assembly for DDPs (a problematic conflation of legislative and executive powers, as we discuss in Part IV).
- vi. Defining a process for site and building application approval (which ideally requires a DDP to guide decisions).
- vii. Constitution of a ‘support group’, jointly by the Working Committee and the Auroville Council, for ‘regular quality auditing of the functioning of the interface team, of each of its members and of each staff member’ (though without defining its mandate and manner of selection, or addressing efficiency concerns with constituting an ad hoc monitoring body for one Working Group alone.²⁵⁰

Interestingly, the 2017 TOR adopted by the Residents’ Assembly, and the 2019 recommendations of the Auroville Council Study Group, are in line with the Selection Committee / Working Committee proposal that was to be led by Vastu Shilpa. Indeed, the debate here went full circle, without any concrete steps towards the DDP, though by this time Mr. Doshi’s proposal had lapsed.

The records do not indicate if the recommendations of the Study Group were subsequently considered by the Working Committee or the Auroville Council. However, three months later, the Governing Board – in a seemingly parallel track to the Residents’ Assembly / Working Committee / Auroville Council restructuring process from 2015 to 2019 – introduced Standing Order 1/2019 to replace Standing Order 5/2011, reconstituting the TDC.²⁵¹ The two Standing Orders are largely similar, and as such, the rationale for this change is unclear.

There is, however, a tension between the 2017 TDC-restructuring and 2019 Standing Order, both in terms of structure and appointment / reporting / accountability structures. The 2019

²⁵⁰ This was a function assigned to the Monitoring and Evaluation Group in Appendix V the Masterplan, for city-wide monitoring / audits, which has not been constituted.

²⁵¹ Auroville Foundation, Standing Order 1, 2019.

Standing Order does not incorporate the dual-track Interface Team/Technical Team structure but requires a 15-member TDC (with ten ‘functional areas’, each vast, distributed between ten members), broadly along the lines originally suggested by Mr. Dattatri in 2010 and incorporated in Standing Order 1 of 2011. The records do not indicate the process that led to the 2019 Standing Order, though a lack of communication and coordination between the Residents’ Assembly and the Governing Board is clear. Some accounts indicate that this matter was discussed with the Governing Board at the time, to apprise them of the 2017 dual-track TDC restructure, with a request to harmonize the 2019 Standing Order.²⁵² This process was inconclusive, with the term of the Governing Board subsequently ending, without a resolution of the matter.²⁵³

This, we may note, was the eighth attempt at altering the structure of the TDC in 13 years, and the twenty-second since 1965, clearly indicating a pattern of discontinuity in governance. Other chronic governance concerns include the adoption of selection processes not tied to competence or qualification, lack of internal division of responsibilities, absence of yearly work plans (other than the ADP-2013) and review/ accountability mechanisms, ambiguous community participation processes, internal gridlocks within the TDC, and the repeated cycling of concerns without clear action since at least 2005. Debates on city-planning in Auroville today must be informed by this fractured organizational history, as is not always the case. At any rate, this presents sufficient reasons to consider a governance rehaul of the TDC today, absent which city-planning work is likely to remain slow and unsystematic. We propose a restructure accordingly below and in Part IV.

d. Study on Development Priorities, 2019

Four years after the Retreat, and on the back of the internal dysfunctions of the TDC, a group of experts led by Suhasini Ayer conducted a fresh study on development priorities for 2021-26.²⁵⁴ Its aims and methodology were similar to that of the Retreat:

The consultants adopted a methodology that would be evidence based to identify the needs and gaps in the present development, to frame policies and programmes that would address developmental challenges in the mid & long term to enable Auroville to ... fulfil the vision that Mother detailed out ... The work was taken up in 4 stages, post analysis of the population growth and demographics to quantify the existing development to the needs of various groups and identify the gaps, if any to prepare development programmes that would address these gaps.²⁵⁵

²⁵² General Meeting, Residents’ Assembly, 2022, 38-39.

²⁵³ Incidentally, we may also note that the 2019 Order requires a review of the Masterplan every 15 years, as opposed to the 25-year time-horizon identified in the Masterplan. This may require attention. Similarly, the 2019 Order requires the TDC to publish a yearly-report on progress in implementing the Masterplan, submitted both to the Governing Board and the Residents’ Assembly – to the best of our understanding, this was not done. In general, as we note in Part IV, a one-time rationalization of existing policies / codes / standing and office orders across bodies is necessary to allow for clear and simple governance mechanisms – a ‘light and tight’ approach – insofar as reporting and approvals processes are concerned. Weak accountability across bodies is in part due to the unnecessarily complex, and thus weakly monitored, web of rules.

²⁵⁴ Ayer et. al., 2019.

²⁵⁵ Ayer et. al., 2019, 4.

Ayer et al. examined several sectors: economy, physical and social infrastructure including water management, energy security, education and housing. An initial data gathering exercise was supplemented by focus groups drawn from the relevant sectors, leading to an articulation of policies, programmes and projects (from general to particular) across each work stream. This work was ‘undertaken to enable ‘evidence based’ detail development plan preparation’, with the participation of approximately 60 residents and twenty-three Working Groups, indicating again a fairly representative base of views.²⁵⁶

The study’s core findings included cyclical stagnation resulting from insufficient capital investment, a slow population growth rate and the unavailability of newcomer housing (as in the ADP-2013).²⁵⁷ Twenty-six projects across sectors were accordingly recommended and discussed at a community meeting called by the Auroville Council with the BCC, FAMC, TDC and Working Committee.²⁵⁸ We discuss these sectorally in subsequent sections as and where relevant, yet we may note that none seems to have been taken up for systematic implementation by the relevant Working Groups involved in the consultative process with the exception of a proposed sub-group of the TDC in 2021 to consider the housing problem.²⁵⁹ In interviews pertaining to the study, lack of community will, absence of an executive mandate for Working Groups, and competence concerns were identified as reasons – as with prior studies, with governance concerns now entrenched.

Subsequently, with the appointment of a new Governing Board in October 2021, these problems were put in sharp relief. The Board’s observations at its 57th Meeting are in line with our findings above:

The Board noted the following in relation to the present status of Auroville Township development:

2.2. There is scattered, sporadic and ad-hoc development resulting in high-cost infrastructure and lack of a cohesive social fabric.

...

2.4. There is a lack of focus on the development of the township amongst the various working groups and Auroville residents.

...

2.6. Housing and other facilities to be developed to welcome more people with commitment to the ideals of Auroville.

The Board is of the view that the following action needs to be taken to accelerate the development of the Auroville Township:

2.1. On the occasion of Sri Aurobindo’s 150th birth anniversary, a fresh impetus must be given to realise the Auroville Township in accordance with the Auroville Universal Township Master Plan within a time frame.

²⁵⁶ Ayer et. al., 2019, 3-4.

²⁵⁷ Ayer et. al., 2019, 2-8, 26-7.

²⁵⁸ See, News and Notes No. 872, 2021, 5.

²⁵⁹ See, News and Notes No. 872, 2021, 5. We were unable to verify if this group was constituted or locate records.

2.3. The ATDC (Auroville Town Development Council) needs to have a work plan, with clearly defined deliverables, time lines, a human resources plan and annual budget.

...

2.5. The ATDC needs to complete the work of preparation of Detailed Development Plans (DDPs) based on the Auroville Master Plan.

2.6. Build the township infrastructure backbone (water, electricity, communication, sewerage, etc.) along the fully cleared RoWs to enable planned urban development.²⁶⁰

With this fresh impetus for city planning, and a focus on the development of the Crown, the notable Dreamcatching initiative – conducted earlier in 2007-2009, 2015 and 2018 – was revived. This exercise took place amidst inevitable tension between the centralizing corrective introduced by the new Governing Board and decentralizing impulses locating decision-making powers within the various communities, given the weak organization of the Residents' Assembly and Working Groups themselves. As our discussion above shows, this tension was in the making since 2003, with the Governing Board voicing concerns explicitly in 2014-15. It came to a head with the appointment of the Governing Board in 2021. We now briefly review these developments from 2021-2023.

ix. Crown Development, Mobility and Transport Networks, 2021-2023

The early proposals for mobility planning by Schmidt, Billinger and Anger in 2001, 2003 and 2005, with calls across the years – by Bhati, Kundoo, Revi, Dattatri, TAG, Ayer, Karl-Heinz Posch, Doshi, Nightingale, ISP, IDPP, Feduchi and others – were largely kept in abeyance, with slow to no movement on proposals to demarcate mobility corridors and rights of way for the Crown, Radials and Outer Ring. As a result, the early gravel roads continued to remain the primary means for mobility, with increasing and unregulated movement of vehicular traffic both by residents and visitors, with some notable exceptions of paver-block roads in the Solar Kitchen Area, Visitor's Centre and short stretches in the Residential Zone. Particularly, proposals to manifest the Crown – a key urban design feature to create a centripetal social fabric amidst the scattered terrain – through a range of expert and community-led work did not translate into action. This was so for a variety of reasons. Key among them are five: (i) disagreements on placement and width particularly in relation to afforested areas and those argued to be environmentally sensitive, (ii) strategies to route through pre-existing village settlements and key parcels in the city area not owned by Auroville, (iii) resistance to urbanization, i.e., to increased densities and growth and planned development (iv) small population numbers rendering investment unviable and (v) a prolonged negotiations, absent a legislative mechanism to authoritatively decide on policy matters and an executive one to implement.

Accordingly, Section (a) considers the 2022 revival of the open-source Dreamweaving forum and reengagement of Vastushilpa to imagine the Crown on the back of the inevitable and necessary centralizing push of the Governing Board looking to break these Gordian knots. Section (b) reviews the apparently competing visions of the Crown in light of Anger's early

²⁶⁰ 58th Meeting of the Governing Board, 2021, 2-3.

conceptualization and the long-standing issue of marking the rights of way of mobility networks to prevent non-harmonious land use. We end with short reflections on good governance practices that may assist in the peaceful and urgent manifestation of both.

a. Dreamweaving the Crown and Re-engaging Vastushilpa

Earlier iterations of the Dreamweaving initiative – with its use of a collaborative ‘open-source planning’ tool – had focused on developing the Crown and Matrimandir Gardens between 2005-2009.²⁶¹ Its aim in this wave was to collaboratively ‘dreamweave the Auroville Crown’:

[The initiative was meant to serve the] need and possible frameworks to bring architects, multidisciplinary experts to work together through a community based participatory planning process. It became clear that the criticality of the moment demanded such an active effort. They thus started pondering upon the structure of a community planning method that would involve Auroville’s multidisciplinary experts and Residents Assembly working in collaboration with highly qualified external experts, in this case the Vastu Shilpa Consultants (VSC) team, which can help take a step towards preparing a convincing Detailed Development Plan (DDP) for Auroville. This work culminated in the method diagram framing the process. Based upon discussions with several Auroville architects, the Dreamweaving coordinators (at that stage, David and Omar [facilitators of the process]) communicated their decision to start the Dreamweaving process with one condition— a clear brief prepared by, or in collaboration with, the Auroville Town Development Council (ATDC). After three months of delays, and with an escalating situation in Auroville, the Dreamweaving coordination team had to accelerate the process, which led to Omar preparing the initial draft of the brief, then modifying it based on comments received from the VSC, David, and the representative of the ATDC (Sreevatsa), as well as inputs from the Dreamweaving architects. Meanwhile, a member of the ATDC, which had been tasked by the Secretary of the Auroville Foundation to come up with a Detailed Development Plan (DDP) for the city, had contacted the Vastu Shilpa Consultants, headed by Dr. Balkrishna Doshi, the eminent Indian architect who had assisted Auroville’s town planning efforts in the past, to ascertain if they would assist in drawing up the DDP for the city. Dr. Doshi and the Vastu Shilpa Consultants expressed their willingness to be involved. In further discussions, it was agreed by all concerned, including the Auroville Foundation, that the first dreamweaving exercise by Auroville architects would focus upon the Crown – the central ring which the architect of the Galaxy, Roger Anger, had described as a ‘circulation space’ – and that the output would be forwarded to the Vastu Shilpa Consultants as material for them to consider when drawing up the DDP for the city.

[Given the events of December 2021] the dreamweaving of the Crown exercise was designed to last only six weeks, involving three weekends at which the architects would present their concepts and ultimately attempt to achieve some kind of collaborative outcome.²⁶²

Alongside, Vastu Shilpa – Mr. Doshi’s architectural firm, whose earlier offer to prepare the DDP was rejected by the community – prepared a work proposal dated 25th January 2021 to

²⁶¹ This was followed in 2019 by a Strategic Plan for Mobility on the Crown by Nightingale. This is an important study building on the 2009 Crownways presentation. We incorporate it in our study of materials in this period.

²⁶² Dreamweaving the Auroville Crown, 2022, 6.

assess Auroville’s planning needs.²⁶³ We are informed that a Memorandum of Understanding to draft a city-wide DDP was prepared. Following the participatory planning method outlined in the initial proposal for the Dreamweaving initiative, a series of exchanges were held with Vastu Shilpa and the peer-group of Auroville architects. Based on all of these, ten designs were prepared and presented to the community for their evaluation and feedback. Twenty (detailed and informative) expert-driven presentations across sectors were made by residents and others.²⁶⁴ A total of 72 residents participated in the process – though here, the mechanism for random selection of residents is not detailed by the Report, which remains a question for future consideration.²⁶⁵

While space limits a detailed consideration of the ‘Dreamweaving the Auroville Crown Report’, it bears mentioning that it was notable for the carefully defined framework it engaged to marry community engagement with expert input. It was (i) inclusive and participatory, (ii) informed by robust expert-driven input – both internal and external, (iii) detailed in its relative assessment of designs presented, and (iv) a lively and robust forum for engagement amongst all involved to arrive at a common solution, addressing the root cause of slow movements between 2001-2022, namely the lack of unity. Notably, the Dreamweaving initiative was welcomed by the Governing Board, in the spirit of mutuality encoded in the AVF Act, 1988:

Secretary informed that a collaborative urban planning tool known as ‘Dream Weaving’ has been developed in Auroville and will be used to provide inputs for the detailed development planning of the Crown. The Governing Board welcomed and accepted this initiative with the following stipulations: (i) Plans and proposals will be consistent with the Auroville Master Plan; (ii) Ongoing works, including the Crown Road will remain unaffected. (iii) The outcome of the Dream Weaving exercise will go to the Auroville Town Development Council as an input for detailed development planning of the Crown.²⁶⁶

As the Report notes, further development of this model can both render practical tools to develop Auroville and contribute to global literature on the subject of participatory urban planning. The challenge, as we discuss in Part IV, in this would be to define the nature and intensity of participation in executive action, which comprise technical rather than ideative matters.

The first time this new method was used as a design tool was for an academic studio for the Integral Health Center (2007), but over the years, different versions of dreamweaving has been used in a number of other Auroville projects, including devising a master plan for the Sustainable Livelihood Institute (2015) and integrating final designs for the Garden of the Unexpected (2018). The most ambitious dreamweave before the present one was the Crownways project (2008), which focussed upon the first stretch of the Crown road. Dreamweaving by itself may not be appropriate for every project for it requires participants to have design skills. However, along with Dreamcatching and Design Cafe (which can involve non-

²⁶³ The records mention both ‘Vastushilpa Consultants’ and ‘Vastushilpa Foundation’, which we assume are the same or related entities.

²⁶⁴ Dreamweaving the Auroville Crown, 2022, 12-19.

²⁶⁵ Dreamweaving the Auroville Crown, 2022, 11.

²⁶⁶ 58th Meeting of the Governing Board, 2022, 5-6.

specialists as well as architects) it is part of a ‘toolbox’ to facilitate collaborative planning and which can be drawn upon for different situations.²⁶⁷

Eight themes were identified in relation to the Crown. First, as a response to the ‘ecology versus geometry’ debate we considered in Part I.B, special attention ‘was paid to ensure the inclusion of architects representing both ends of the spectrum regarding the design of the Crown (one extreme being that it should be perfectly circular as per the Master Plan 2025 Perspective Framework, the other extreme being that ground realities should take precedence).’²⁶⁸ Here, it seems from the review presented that most participants favoured a creative integration of ground realities with the central mould of the Galaxy, along the lines we discussed in Part I.B with reference to Anger, Doshi, Heymann and others. Second, the Crown was imagined as a cultural space rather than just a road designated for mobility, as with Anger, 1969, Kundoo, 2007, Feduchi, 2014 and others. Third, each section of the Crown was oriented to its respective zone, with aesthetic, visual interest – in short, a dynamic built profile. Fourth, the natural width of the Crown was used to develop this dynamic profile. Fifth, pedestrians were given priority (as Anger’s 2005 Mobility Plan highlighted), with shared public transport systems to limit vehicular usage. Sixth, there was a push to synthesize the urban form and bioclimatic principles peculiar to Auroville, so as to bring together the varying emphases of the Galaxy, city and nature. Seventh, the Crown was designed to harness/support water catchment features in the urban design, a key concern highlighted in Feduchi, 2014, the 2014 Land Suitability and Land Use proposals and 2013 Water Sourcing Study. Eighth, built-up spaces in and around the Crown were integrated with the ecosystem. Ninth, a phased increase of densification was imagined, beginning with acupuncture projects. Tenth, existing facilities in the Crown corridor were to be enhanced.

While the devil, we suppose, lies in the details of each proposal, there seems to have been a broad overlap on the imagination of the Crown and the need to secure the form of the Galaxy with ground realities, across the three streams of participants, namely the experts across disciplines, focus groups and randomly selected residents. Translating these well-articulated priorities into a DDP was the next logical step.

The stars, however, did not align. At the conclusion of the process, contrary to the understanding that ‘the output would be forwarded to the Vastu Shilpa Consultants as material for them to consider when drawing up the DDP for the city’ as well as to the TDC, it seems that this was not done. In our interviews, we were unable to identify the reasons that led to this breakdown: it is unclear which of the two stipulations placed by the Governing Board – proposals be consistent with the Auroville Master Plan and ongoing works, including the Crown Road, remain unaffected – was breached by the initiative. In either case, this four-way collaboration between resident architects and planners, external experts, the community and the TDC – which could have served as an ideal model to draft the long overdue DDP – thus fell through.

We were informed at the time of our research that the Memorandum of Understanding with Vastu Shilpa Consultants was not finalized, and instead, one was signed with the Central Public

²⁶⁷ Dreamweaving the Auroville Crown, 2022, 8.

²⁶⁸ Dreamweaving the Auroville Crown, 2022, 8.

Works Department ('CPWD') for the preparation of a DDP in addition to works on the Crown. The minutes of the 61st Meeting of the Governing Board record that 'CPWD officials who are in charge of Auroville works, have prepared the work plan for implementing the Masterplan, with the help of the TDC.'²⁶⁹ We were unable to access the MoU or subsequent work plans developed by the CPWD, which were not available with the TDC or the public domain, and awareness in the community of this arrangement was limited. The Crown has, as far as our understanding goes, since been developed by the CPWD, subject to the directions of the National Green Tribunal, which has invited some criticism from the community, for failure to adopt a consultative approach, and from experts, over technical considerations.²⁷⁰ As far as we are aware, no development plan in relation to the Crown has yet been developed, which is a necessary prerequisite to development works.²⁷¹ We may remember here Heinz-Posch's caution in 2010 that the upgradation of roads without mobility planning is likely to result in an increase of motorized traffic – having a mobility plan in place as development proceeds is a pressing concern.

b. Imagining the Crown and Non-Harmonious Land Use

In relation to the development of the Crown, radials and mobility networks, we note that the Dreamweaving effort came after substantial previous work building on Anger's early proposals. Our review here is short, again as a representative overview, rather than a detailed examination of alternate imaginations proposed, to draw appropriate inferences in relation to governance priorities. Disagreements appear to have arisen on two counts: first, the imagination of the Crown and its mobility and design features, and second, mapping ground realities to the imagination while preventing non-harmonious land use by marking the right of way.

1. Imagining the Crown

On the imagination of the Crown, the Masterplan identifies it as a 'special use zone':

[the Crown] traverses all the four zones in a concentric fashion with a width of about 75 meters, consisting of a circular road with buildings facing it. This is termed as the 'Crown Area'. This Crown area will provide most of the service facilities required to support the activities in the four zones mentioned above. The developments in the Crown area will naturally be somewhat different, depending upon its proximity or interface with each zone. For the purposes of zoning regulations, the crown area is considered as a separate zone under each of the four zones.²⁷²

The Masterplan accordingly marked approximately 1.3% of the city to the Crown, with defined uses across the four sectors: in the Residential Zone, it was to include shopping, utilities, communication, recreation and community facilities of higher order, supporting residential use; in the International Zone, it was to include utilities, communication, shops and other common facilities related to the main activity in the International Zone, including housing and staff quarters; in the Industrial Zone, it was to include hostels, dormitories, guesthouses and

²⁶⁹ Auroville Foundation Governing Board, 2022, 6.

²⁷⁰ See, for example, Maïni, 2022.

²⁷¹ General Meeting, Residents' Assembly, 2022, 11.

²⁷² Masterplan, 2001, para. 2.5.4.

supporting facilities for the main activity in the zone; in the Cultural Zone, shopping, utility, communication and recreation centres and related facilities supporting cultural activities in the zone, including housing.²⁷³ This zoning, as in Anger's understanding of the Crown as a 'circulation space', 'primarily ... as an area facilitating social interaction of Aurovilians ... a shared space that unifies' indicates that it is not to be simply a road, but a corridor of aesthetically enlivening public spaces acting as a centripetal focus of the town's energies.²⁷⁴

The ring [later the Crown] – itself encircled by a hundred metre-wide canal where artificial islands will provide a rhythm, a dwelling place for various aquatic birds, where 21st century gondolas will leisurely circumnavigate – will be the intersection of all sectors, the town's centripetal focus. This is where, in addition to the fairy-like charm of canals, the main commercial centre will be located. Here one will find theatres, sports grounds, recreation halls, gardens for meditation, forums for meetings, hotels ... visitors galore, of course, since Auroville is not a closed town, but a town open to the world and the urbanist [town planners] must never forget this essential openness.²⁷⁵

This imagination seems to be incorporated in Schmidt and Billinger, 2001, Schmidt, 2003, Anger, 2005, Kundoo, 2007, Feduchi, 2014 and in the eight themes discussed in the Crownweaving Report. As such, the Dreamweaving initiative provided fertile ground to move the discussion forward with the external consultants, Vastushilpa. As Nightingale reasonably notes, the Crown is both an engineering and a design challenge, and as such, the mobility effects of a proposed construction ought to be considered carefully: 'how the whole connectivity and energy flow of buildings and spaces, and the movement of people' is maintained.²⁷⁶ His remarks, echoing Schmidt's insightful 2003 essay and views expressed during several interviews, are pertinent:

Yes, the traffic planner Karl-Heinz Posch predicted this back in 2008 and advised against it – it's naïve to think that we can build all these roads, and then everyone will be just cycling on them or taking electric buses. Those hopeful visions ignore present circumstances and human nature. Unfortunately, humanity only usually wakes up once we've made some mistakes. The Dreamcatchers presented an alternative Crownways in 2008, before the road was paved, to show how we could create beautiful public spaces which would not encourage fast, heavy traffic.

I'm suggesting we develop an alternative mobility in phases, and create a series of urban spaces along the Crown. And where the *peramboke* [common village] land crosses the Crown, you'd have a crossover point, a place where someone coming from Certitude can park their noisy vehicle, and get on an electric cycle or take a shuttle and spend a couple of hours going around the Crown, doing their shopping and going to the library, and then park the electric cycle and get back on their vehicle to go back to Certitude.²⁷⁷

²⁷³ Masterplan, 2001, para. 2.5.6, Table 12.

²⁷⁴ Feduchi, 2014, 123.

²⁷⁵ '1', 1968.

²⁷⁶ Auroville Today, October, 2020.

²⁷⁷ Auroville Today, October, 2020.

Similarly, the 2010 ISP Mobility Stream suggested an imagination of the Crown where pedestrian, cycle and public transport would weave along the Crown, rather than run linear to it, to both preserve the integrity of the form and flows of the Galaxy and avoid a ‘road’ on the ‘inside’:

The Crown, as outlined in the original Galaxy Concept, has a dynamic shape with variations in its widths, differential in distance from its centre, playful in its variety of covered and wider open spaces, full of surprising vistas while moving along this particular kind of urban, human-scaled space. The integrity of the Galaxy shape is preserved with a Crown that leaves the Galaxy's flow of energy uninterrupted from the Matrimandir into the complete Galaxy without being blocked by a perfect circular "three-lane road" with buildings situated only on the "inside" - creating an unnatural separation and barrier between the centre and main surrounding zones of AV. The pedestrian, cycle and public transportation should be embraced by the Crown, not attached alongside it.²⁷⁸

Whilst the particular design statement expressed here may be subject to variation, the general concern with conscious mobility and aesthetic sense, such that the physical space reflects the social logic of a spiritual society and invites residents to commune at the public space, is important to note. A similar sentiment was expressed by the TDC at the August, 2022 General Meeting of the Residents’ Assembly, with the important remark that the long-standing discussion on this point needs to translate into urgent action:

There is a strong urge to manifest the crown. And the road just one element of the crown. Parks, services, residences. It is very green. And the road, which meant for cyclists and pedestrians. The road is meant for only emergency traffic. It is not a 12 m wide lane, where you can go at 80 ... km an hour. That is ridiculous and never foreseen. Secondly, we feel a strong urgent on the table, in the foundation office, and more parts of Auroville. So, keep that in the background. And we in the TDC are quite happy with this. Because after 40 years, we have hardly realized anything in the Galaxy ... Over all these years, we have hardly managed to get something visual out of it.

...

One of the themes to explore is mobility. We need to be aware that the traffic has currently got out of control in Auroville ... What we see now on the crown, cars and motorbikes, was never meant to be! One idea, if the Crown comes, is to close it for all traffic except for cyclists and pedestrians from morning till evening ... we made a mistake in this crown road which is there. And step by step, we come up with some kind of an evolutionary model where we allow only certain kinds of traffic.²⁷⁹

As we discuss in Part IV.E, Sri Aurobindo, Mother and others’ emphasis on the importance of public spaces for engendering solidarity and communal self-identification is represented focally in the Crown, which makes it an urgent element to manifest. Posch, Nightingale, IDPP and other proposals to develop one sector or street in each Zone, as ‘acupuncture’ projects with an increased densification, in a phased but time-bound manner appears, given the records we have studied, an effective strategy to develop the Crown. In this, incentives to invite social

²⁷⁸ ISP Mobility, 2010, 1-2.

²⁷⁹ Residents’ Assembly, General Meeting, August, 2022, 16-7.

infrastructure (restaurants, cafes etc.) developed by residents on the ‘Auroville Main Road’ / Kuilapalayam, deflected as it were to the fringes, to acupuncture zones in the city area may be examined. We may note here that similar proposals have been pending since the mid-2000s reviewed above, but action on this count has been absent.

As we discuss above in section (vi), this emphasis in relation to building the Crown came in the early mobility planning studies between 2003-2011, led by Anger, Doshi and Posch. While they were early for its time, a look back is relevant today. The 2005 study notes that the ‘shape of the Galaxy’ has some ‘inherent advantages’, namely reducing transport time, allowing a better interaction between the residents, bringing together the prominent activities specific to each zone and a pedestrian-friendly mobility along the ring, with the need for private vehicular usage replaced by (relatively) non-polluting public shuttle services.²⁸⁰ Interestingly, it proposes the Crown as a pedestrian boulevard, with shuttle services running every 10 minutes (and a walking time of 63, 114 and 228 minutes for the circumference of the Crown, Outer Ring and Green Belt respectively), the Radials as regulated carriageways with similar boulevards, the outer ringroad as a carriageway with cycling paths and a series of service roads for maintenance, delivery, waste disposal etc., and finally, green corridors providing ‘circular’ connectivity crossing over the Radials and merging eventually with the local landscaping.²⁸¹ These proposals were discussed and partially incorporated in the 2007 Crownways study, the 2009 CSR-CEPT work and Posch’s 2010-11 presentations, with the last proposal of a Green Corridor incorporated by Feduchi in his 2014 Draft Detailed Development Plan for Residential Zone Sectors 1 and 2. These serve as a useful template for further action. A similar proposal for connected urban-woodlands / green corridors for urban farming is mentioned in the 2017 TDC-TOR.²⁸²

²⁸⁰ Auroville’s Future, 2005, 4.

²⁸¹ Auroville’s Future, 2005, 9 (‘Besides the Radials alternative connections between Outer Ring Road and Crown will be provided by shaded (natural foliage) pathways for pedestrians and cycles – Green Corridors. These corridors will also provide ‘circular’ connectivity, crossing over the Radials. The reserve widths of these will be initially 30 meter, eventually being merged into to the local landscaping and gardens of the areas it passes through, adjusting to varying conditions and architectural design factors. Cyclists will have their own independent track to avoid disturbance of the pedestrian movement.’)

²⁸² TDC Terms of Reference, 2017, 2.2.1.2

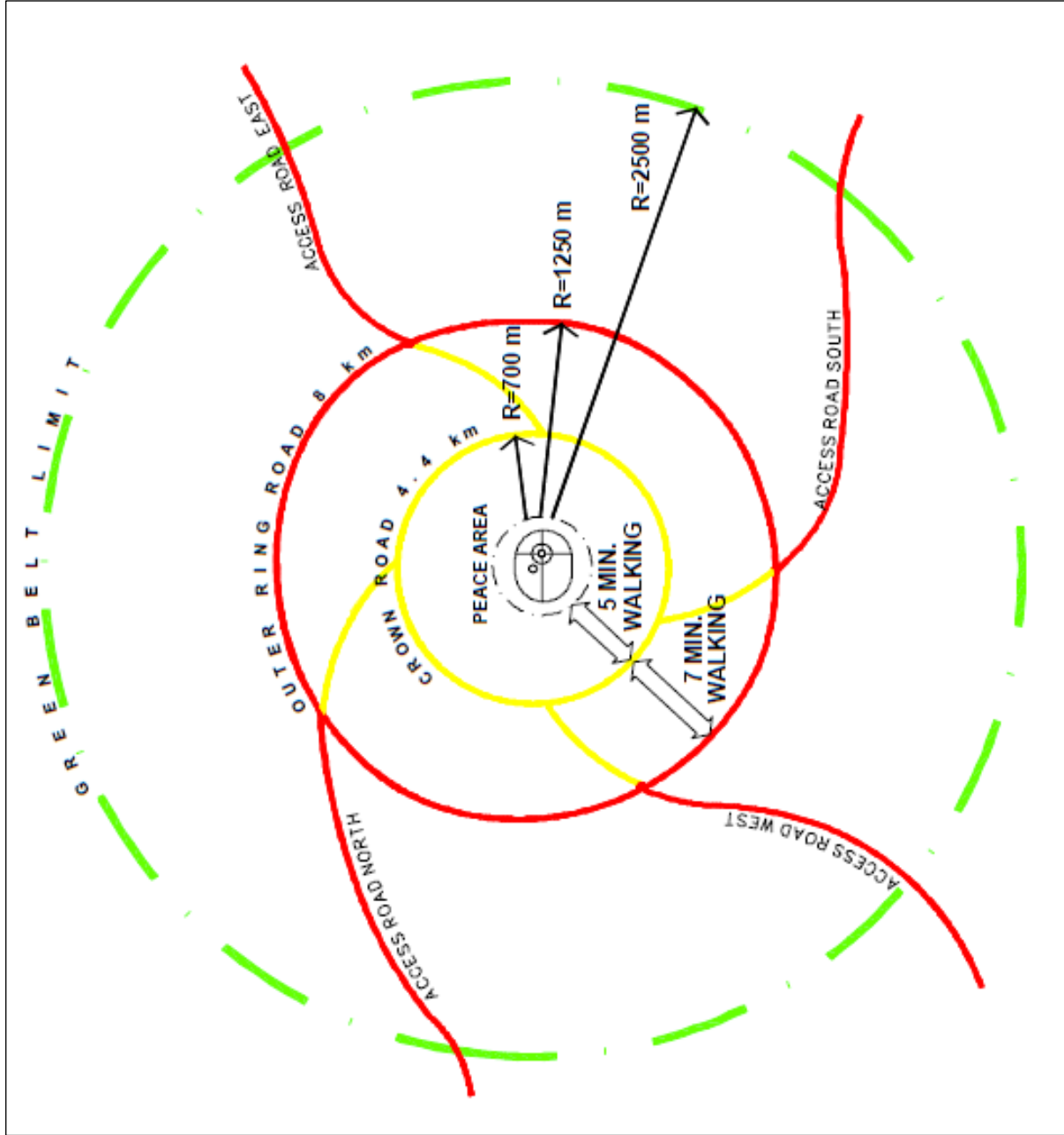

(Mobility dimensions. *Source: Billinger and Schmidt, 2001, 9)*

Bicycle speed (15km/h). Halfway around the crown (2.2 km): 9 minutes. Halfway around the outer ring road (4km): 16 minutes

Alongside, the study proposed primary and secondary service nodes for vehicle transfers (similar to Nightingale’s suggestion above), and proposed that all vehicular traffic will remain outside the city limits. For this, it suggested that it would ‘an excellent project if a team in Auroville starts developing such a system of public transport’ to allow for a phased reduction of private vehicles, currently used on Auroville roads in 2023, but that this ‘will require the understanding, acceptance and support of the community.’ Again, Posch reiterated Billinger and Schmidt’s partial detailing out of one of the Service Nodes to serve future efforts.

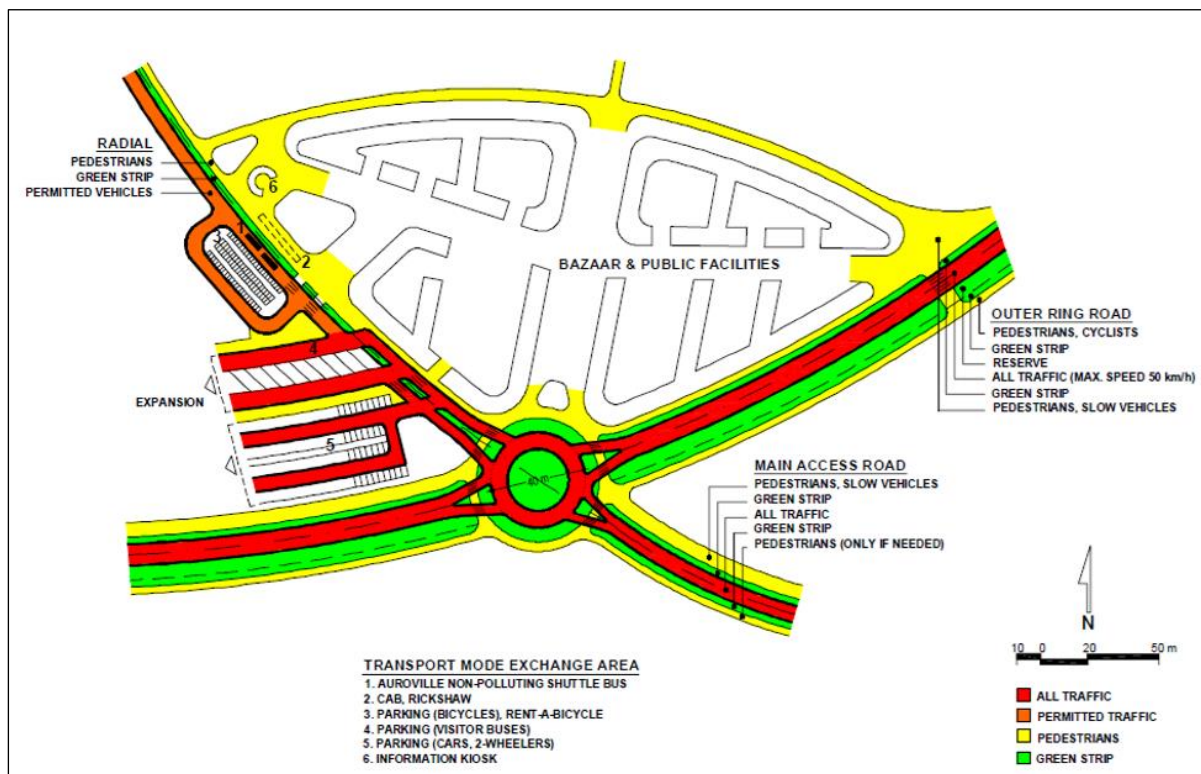

(Example, Service node (south). *Source:* Posch, 2011b, 22)

Though the need for traffic and mobility planning was highlighted in the 2017 TDC-TOR²⁸³ – with similar ideas addressed previously, starting with Mother’s 1969 Ford Foundation letter that anticipated the detailing of a ‘transport network’, onwards to Revi, 2007, IDPP, 2014, the 2021 Auroville Crownway Study and the 2022 Mobility Forum – no mobility plan is yet available.

As such, each of these studies support the need for a Crown design that is sensitive to the dynamics of mobility, with a time-bound plan given the increasing number of private vehicles, the aesthetic and communal vision and preservation of priority environmental areas (subject to our discussion on this point in Part I.B). At any rate, the Crown must be conceived as more

²⁸³ TDC Terms of Reference, 2017, 2.1.3. We may note here that there is a tension between Billinger / Schmidt / Auroville’s Future studies and the TOR: the former indicates zero-private ownership of vehicles (cars and bikes), with public shuttles, but the latter envisages 75% two-wheeler traffic.

than a road: ‘this is needed to allow urban public space to cater to more than transport functions and mobility values ... providing a rich public realm to the largest number of inhabitants (both human and non-human) replacing the policy focus on enhancing mobility or even on just enhancing accessibility.’²⁸⁴ Its urgent manifestation is critical for the centripetal force Auroville requires today given the urban sprawl and ensuing social dissipation.²⁸⁵ This task was slated to be conducted to a large extent in Phase I of the Masterplan, ending in 2010, yet has witnessed an significant delay. The 2017 TDC-TOR foregrounds this concern:

Development plans should focus on creating an urban fabric informed by the key elements of the Galaxy [including the Crown], by siting projects and developments to change its character from the existing sub-urban sprawled environment into a concentrated development which gives the feeling of living in an urban environment.²⁸⁶

The concern that has allegedly held back development is the precision with which Mother’s symbol is manifested. Proposals seem to differ at a subtle, technical level in relation to the approach of integrating the urban form (the Galaxy plan) with the natural features along the land designated for the Crown, the ‘ecology versus geometry’ debate we discussed in Part I.B. One approach is to follow the circular pathway of the Crown as highlighted in the Galaxy plan which involves clearing some of the existing developments on the designated land and ‘design’ the Crown as a shared public space with newly built-in natural features. The other approach emphasizes weaving the Crown as organically as possible following the natural landscape, meandering through trees or existing underground water catchment areas below the land. The four illustrations below highlight contrasting visions.

²⁸⁴ Bertolini, 2023, 2359-60. *See also*, Anger, quoted in Feduchi, 2014, 123.

²⁸⁵ This is also an area with significant funding opportunities, to generate a research centre / cell integrated within city works. IDPP, 2014, 55 suggests an approach to EMBARQ, ITDP, Shakti Foundation, Ministry of Urban Development, Government of India, UNDP and the World Bank, which may be explored.

²⁸⁶ TDC Terms of Reference, 2017, 2.1.4.3



(Crown designs. Clockwise from top-left: Auroville Master Plan Exhibition, Anupama Kundoo at Bharat Nivas; Crown section woven along naturally built-in water catchments and swales; Presentation by Ganesh and Neha, Dreamweaving the Crown session, 2022 with dynamic inner and outer edges; Source: Kundoo, 2007; Dreamweaving the Crown, 2022)

Clockwise from the top left, the first is a section of the Crown following the path of natural water catchments and swales in the area which ‘can be designed for the dry season as social infrastructure with small scale amphitheaters, courtyards and landscape elements that hold water in the wet season and, conversations the rest of the year’; the second is a symmetrical design of the Crown with a smooth road and surrounding mix of social, service and environmental functions; the third is a vision of the crown as a perfect concentric circle; and the fourth as a ‘dynamic profile’ along the inner and outer edges, with densities that change as per the local conditions and requirements of the area it crosses, thereby changing in width in different areas.

It is beyond our domain expertise to enter this design debate, beyond reflections offered on the ‘ecology versus geometry’ debate earlier in Part II. We offer the following reflections as a matter of good governance practices:

- i. We suggest that the (rare) mutuality demonstrated in the Dreamweaving initiative between the Governing Board, internal experts, external consultants, the community and the TDC provided a refreshing pathway to resolve this concern – subject to the flexible constraints of the Masterplan, we suggest that the causes that led to the abrupt, and insofar as our research goes, unexplained, breakdown at the final stage of the process can be revisited with a view to the shared manifestation of the Crown as an expression of a *unified* intention. This fraternal frame, as Mother repeatedly noted, is key to effective action: in this, whilst the centralizing corrective of the Governing Board and / or Residents’ Assembly appointed Working Groups, tasked with clear executive powers of implementation, is necessary given historical inaction within the community on this count, if community support is engaged as in the Crownweaving report, it presents ideal conditions that can be harnessed.
- ii. In relation to the relative placement of the Crown in Darkali forest, the records indicate that: (a) the precise location of the right of way has varied over the years, from the 1995 plan to 2023;²⁸⁷ (b) there was an understanding between the early stewards of the land and Anger, to place the forest alongside the Mahasaraswati Park; (c) this was taken up by the TDC in 2009, given that the forest growth had varied from the original designation, in a collaborative move to indicate that parts outside the designated area ‘will be subject to change as per the design as and when this area is detailed out’, with the assurance that the TDC ‘will consult and involve ... the stewards of Darkali in the design process to ensure that the integrity of the forest is maintained’;²⁸⁸ (iv) the area is argued to be environmentally sensitive and necessary to maintain ecosystem services: the Report of the Joint Committee appointed by the National Green Tribunal considered these matters with recommendations to allow for preservation of the tree cover as far as possible. We were not able to access the entire archival record on this point – subject to that, it appears that the historical intention, in Anger’s and the TDC’s documents, was to

²⁸⁷ L’Avenir d’Auroville, 9th April, 2009, 2.

²⁸⁸ L’Avenir d’Auroville, 9th April, 2009, 1.

develop the Crown *through* Darkali *whilst* preserving the integrity of the forest; (v) thus naturally, some loss of green cover is inevitable and anticipated, but a common and collaborative plan seems possible: with a robust environmental audit led by experts, to clearly and conclusively determine the sensitivity of the ecosystem / priority and non-priority areas that can or cannot be altered *and* a commonly agreed compilation of the historical record, given that information is available piecemeal in scattered sources and leads to uninformed debate. Keeping these matters in abeyance has added to avoidable uncertainty and conflict. The records we were able to study did not speak as to the reasons for the movement of the Crown from Anger's 1995 proposal to the 2023 plan – but in any case, given the city-building imperative today and varied correspondence historically (on the width and placement of the Crown), it is urgent and necessary to arrive at a clear agreement, for Darkali as also other lands, as to the width of the right of way and precise placement that all can abide by so as to avoid disagreements in the future. What started as an architectural or design debate seems to have grown into an unhealthy social division.²⁸⁹

- iii. Concerns reasoned out in the 2021 Crownway Study, with suggested proposals, merit consideration and resolution – to the best of our understanding, these have not been incorporated into the current development works on the Crown. Whilst proposals may indeed be rejected by the TDC / external consultants contracted for the purpose, with alternate design solutions preferred, norms of public rationality key to good governance dictate that this be done with openly-stated reasons to generate a culture of transparent decision-making.
- iv. As we discussed in Part I.B, there is a need to distinguish between two issues. The first are deliberate constructions made to block developments. These must, in line with the Masterplan, be urgently and peacefully removed with public notice. The second are legitimate constructions and tree plantations made earlier. These can be sensitively relocated while providing alternate living arrangements and preserving the total green cover, with an environmental audit conducted to identify environmental hotspots that are in fact necessary to maintain the ecological balance. In this, all efforts may be made to explore solutions – such as those proposed in the Land Use and Land Suitability Proposal and the Crownweaving initiative – to integrate them into the natural width of the Crown whilst preserving the symbolic geometry. Reports, statements by the TDC, and our conversations with experts indicate that these are not mutually opposed at the level of detail. This, we may note, was also the proposal of the 2017 TDC-TOR: 'The Crown ... has a natural width which is flexible and is set with the aim of maintaining the continuity of its urban form. The width of the Crown remains flexible to allow local variations and openings in the building fabric and in keeping with the zone it passes through.'²⁹⁰

²⁸⁹ General Meeting, Residents' Assembly, 2022, 14-15.

²⁹⁰ TDC Terms of Reference, 2017, 2.1.3.7.

In sum, the manifestation of the Crown, as the much-needed centripetal force to bind Auroville's social fabric, is necessary and urgent for the 'city' to emerge. The inordinate delay – that we can trace to inertia and a dilution of the vision, the *rajasic* sense of possession and difficulty in reconciling competing imaginations – requires a firm corrective. This push must be conscious of the ecological and urban design imperatives highlighted in Anger's conceptualization and since, yet not excessive in either extreme. The loss of some tree cover is inevitable and necessary, but sections indispensable to the ecological balance will require integration. Equally, mobility and design principles require that development works be consciously conducted to manifest the Crown as more than a 'road', with an arrangement of social and physical infrastructure sensitive to the aesthetic and spiritual vision. This is no doubt not an easy task: a unified vision to manifest the City Centre and Crown with two time-bound 'acupuncture' projects in each Zone in the short-term may generate the necessary momentum, yet care must be had that the aspiration for consensus does not translate to a veto for any individual or community.

2. *Marking the Rights of Way and Non-Harmonious Land Use*

On the issue of non-harmonious land use, we note that whilst the development of the Crown may happen in phases – though, as the Governing Board notes, in a time-bound and urgent manner – marking the rights of way is critical in anticipation of that work.²⁹¹ The records on marking the right of way go back to the first 'crown walk' conducted, as per our understanding, in 1985. At the time, given the environmental imperative of the early years, afforestation and land generation efforts were conducted across the plan area, including on common spaces. Efforts to mark the right of way gained steam post the 2001 Masterplan. The 2003 Directions for Growth Report proposed the 'demarcation and utilization of the Crown Road alignment', the symbolic opening was celebrated six years later on 28th February 2009 by the Crown Cycle and Eco-Friendly Vehicle Rally and demarcation work finally began in 2009.²⁹²

This work, however, has been repeatedly frustrated by many accounts. In a meeting of the Infrastructure Services Coordination Team on 3rd November 2012, it was agreed with the TDC as follows:

Toby [from the ATDC] asked whether the team agreed that not only the ROWs but also the main urban footprints such as parks, lines of force and lake should be marked on the ground. It was felt that this must indeed be done.

It was agreed that the following roads need to be built on a priority: – The entire Crow – The Schools radial – The Pony Farm-Darkali radial Toby will inform Auroville Road Service before 15-10-2012 as to which road can be taken up immediately.

...

Auroville Road Service will mark the crown (and subsequently the remaining roads with concrete block markers of 70 x 35 x 11 cm which will protrude 5 cm beyond the existing ground level. For the Crown these markers will be installed every 12m at

²⁹¹ 58th Meeting of the Governing Board, 2021, 3.

²⁹² Masterplan Directions for Growth, 2003, 39; Auroville Foundation Annual Report, 2008-2009, 11.

both sides of the ROW (respectively 681 m radial distance from the Banyan and 699 radial distance from the Banyan, with 690m as the centre line).

...

Toby suggested, and the meeting agreed, that radial roads should be named and that road signs are placed for each radial. Alain mentioned that a lot of road signs that Auroville Road Service has installed have been removed and therefore the radial road signs have to be of solid material. Toby will issue the Work Order and Auroville Road Service will implement in phases.²⁹³

Alongside, an Infrastructure General Layout Design was proposed and accepted by the TDC on 26th March, 2012, to lay the required common trunk infrastructure necessary for a systematic development of the existing (and future) social and physical infrastructure.²⁹⁴ This seems to be in line with the with Maps 11 and 11A of the 2005 Mobility Plan. Given resistance to this movement, a detailed ‘exploratory meeting on the right of way’ was conducted by the Secretary to the Foundation on 5th June 2012, prompted by two letters from the Infrastructure Services Coordination Team to the TDC and Mr. Doshi,²⁹⁵ with members of the Working Committee, TDC, TDC Advisory Council, Water Harvest, Road Service, AV Electrical Service, Auroville Council and twelve residents, to consider conflicting views on the matter:

Various viewpoints were expressed and arguments for and against immediate clearing of Right of Way were heard for more than two hours. Out of the meeting, consensus emerged on the following points:

1. The perspective Master Plan of Auroville prepared in consultation with the Residents Assembly by the Governing Board and notified in the Gazette by the Government of India shall form the basis of further planning of Auroville.
2. It was recognised that Detailed Development Plans are being prepared for individual sectors / zones demarcated in the perspective plan.
3. It was agreed that Right of Way demarcation for the Crown, Radials and the Ring Road should be completed within a realistic time frame. It was noted that demarcation work was started in 2009-2010 and that there should be no difficulty in completing this work.
4. It was further agreed that obstacles / difficulties in ensuing Right of Way as per perspective Master Plan such as land not owned by Auroville, existing construction etc., should be identified and a clear action plan should be drawn up to deal with them within a specific time frame.
5. Finally, it was agreed that whenever an infrastructure service has to be laid on any stretch of the Crown, the twelve Radials or the Ring Road, such as a road, electrical cabling, optical fibre cabling or water supply lines, that stretch would be cleared as per Right of Way requirements. Disputes and obstacles would be dealt with in a flexible and proactive manner.²⁹⁶

²⁹³ Infrastructure Services Coordination Team and Town Development Council, 2012.

²⁹⁴ Crown Road Section Final, ‘Infrastructure General Layout Design’, 2012.

²⁹⁵ Infrastructure Services Coordination Team and Town Development Council, ‘Clearing of Right of Ways’, 29th February, 2012; Infrastructure Services Coordination Team, ‘Clearing of Right of Ways’, 27th March, 2012.

²⁹⁶ Secretary, Auroville Foundation et. al., Exploratory Meeting, 2012, 1-2.

A further open meeting was held by the Infrastructure Services Coordination Team on 3th October, 2012 at the Town Hall to generate support,²⁹⁷ and a year later, on 29th July, 2013, a common meeting was held between the Governing Board, Secretary, Working Committee, Town Development Council and TAG. All bodies reiterated that the ‘TDC [is] to finalise and mark the Crown ROW routing and all underground services to be laid along that ROW in the designated service corridors on both sides of that ROW. The same to be done for the 12 radials.’²⁹⁸ Despite this consensus, records indicate that the work did not proceed.

Subsequently, four years later, designs for the underground infrastructure corridor were sanctioned by the TDC on 9th September, 2016 and again on 21st February, 2020 with a width of 16.7 metres, as compared to 18 metres approved by Anger in 2005.²⁹⁹ In May, 2020, the continuing delay prompted a letter from the Auroville Electrical Service to the Acting Secretary:

We would like to inform you that till date the right-of-ways (ROWS) have not been cleared and the HT cable, which runs from the HT receiving station to the Solar Kitchen, remains inaccessible for maintenance and repair for a long stretch.

As explained during your site visit and in our letter under reference, full width clearing of the main ROWS (the Crown, the 12 radials, the international zone loop and parts of the outer ring) is an essential part of all infrastructure development, operation and maintenance including electricity, water distribution, communication systems and mobility.

As the numerous efforts made by us and by other Auroville infrastructure services with the Auroville Town Development Council (TDC) have not yielded any results in this regard, we urge you again to issue the necessary instructions as you had offered to do during your site visit of 30-07-2019 in the interest of a comprehensive and responsible development of Auroville’s infrastructure.³⁰⁰

The records do not indicate the Acting Secretary’s response to this matter. In any case, subsequently, further designs for the corridor were sanctioned by the TDC on 4th November, 2021 along the same lines.³⁰¹ Again, records indicate that the work did not proceed apace. Subsequently, as efforts to build the Crown gained speed in 2021, the matter prompted the following direction from the Governing Board:

Master Plan right-of-ways (the Crown, radials, outer ring and international zone loop, etc.) have not been cleared, resulting in haphazard infrastructure development at high installation and maintenance costs.³⁰²

The proposal of conducting a drone survey of master plan right-of-ways (RoWs) was approved. It was noted that the topographical survey may take 2 to 3 months and that

²⁹⁷ Infrastructure Services Coordination Team, 3rd November, 2012.

²⁹⁸ L’avenir, 2013a, 3.

²⁹⁹ Town Development Council, ‘Service Corridor Drawings: Crown Road’, 2016; Town Development Council, ‘Right of Way Cross Section: Crown Road Plan showing Schematic Road Layout, Section showing Infrastructure Corridor Details’, 2021. This figure of 30 meters has since been clarified by the TDC to be incorrect. General Meeting, Residents’ Assembly, 2022, 13.

³⁰⁰ Auroville Electrical Service, 2020.

³⁰¹ TDC, ‘Crown RoW-cross section with infrastructure corridors’, 2021.

³⁰² 57th Meeting of the Governing Board, Auroville Foundation, 2021, 2.

the work will be executed in two-phases. It was further decided that Crown RoW clearing and infrastructure work must proceed, while tree clearing can happen after the Stay issued by the National Green Tribunal (South Zone) in Original Application No.239 of 2021 is lifted.³⁰³

Comon spaces such as the Crown, Radials and Outer Ring are *common* spaces, central for the effective manifestation of the city and easy mobility across sectors: as such, marking the rights of way, even if actual construction or development happens subsequently in a phased manner, is important to both signal a clear intention to develop a common mobility infrastructure and prevent non-harmonious development, whether deliberate or otherwise. The 2017 TDC Terms of Reference codify this view:

Lands that will not be developed either in the long term or medium term will be put under planation, temporarily utilizing it for short term wood harvesting in a way that is possible to revert to the proper zonal land use at the time when that particular area will be developed. However, infrastructure that serves the Township as a whole or a zone or sector of the Township shall be installed in such temporary woodland areas through designated service corridors which are kept clear from vegetation with accessibility at all times for maintenance. These service corridors shall coincide with the rights of way earmarked for mobility and other infrastructure service requirements.³⁰⁴

Relocation / rehabilitation can be offered in cases where there is a requirement to displace people in case of a conflict of land use. The extent of this needs to be defined. e.g. in which cases can it considered not necessary (for example, when someone has signed an agreement accepting temporary stewardship of the space). In all such cases, the wider interest of Auroville as an evolving township will override personal preferences or attachments.³⁰⁵

Particularly, increased densification of the Residential Zone, development of manufacturing and others clusters in the Industrial Zone and enhanced social infrastructure in the Cultural and International Zones – each urgent tasks – require that such investments be made *prior*, to accommodate subsequent developments without lag. Importantly, given our discussion on the imagination of the Crown, we note that marking the rights of way, and laying down the necessary infrastructure, does *not* preclude further planning choices, such as preserving some Radials (as many suggested) as pedestrian or non-motorized pathways, with increased green cover, or similarly developing sectors of the Crown in a phased manner in line with Anger’s proposed imagination, supported by the Masterplan. The 2017 TDC-TOR codifies this view explicitly:

Underground infrastructure corridors (for water, electricity etc.) will follow the route of permanent cleaned, cleared and accessible ROW’s irrespective of them being used or not eventually for mobility.³⁰⁶⁷

To both boost development in the city-area, have the capacity to absorb social infrastructure as time demands and prevent disorderly construction in the meantime, the underground

³⁰³ 57th Meeting of the Governing Board, 2021, 9.

³⁰⁴ TDC Terms of Reference, 2017, 2.2.1.5.

³⁰⁵ TDC Terms of Reference, 2017, 2.2.1.1.

³⁰⁶ TDC Terms of Reference, 2017, 2.1.3.9

infrastructure corridor is necessitated now. As such, the loss of green cover associated with these activities (which occupy 1.3% of the city-area, minimal as compared to the overall plan scheme) can be addressed appropriately as suggested above, without affecting the overall ecological imperative of Auroville. Given that Auroville now requires the necessary push for city-development, in a phased transition from the environmental concerns that rightly predominated the first stage of development to a balanced approach to urban development, establishing common facilities that enable this phase shift, to counter to cyclical stagnation demonstrated in the records, is necessary and urgent today. The delay, and as the documents indicate, reluctance (in some cases, active resistance) to this process is contrary to the explicit terms of the Masterplan and the urgent manifestation of the Galaxy. The marking of these rights of way has been subject to a long and, as it appears from the record, unnecessary delay post 2010.

3. Resolving Land Use Issues on the Radials for Future Development

As city-building takes centre stage, pending land use concerns ought to be resolved as early as possible to avoid uncertainty and future conflict. The 2014 Land Suitability and Land Use Proposal, in particular, is relevant here. It is the only reasoned-out and comprehensive study in the records made available to us with concrete proposals in relation to land use concerns along the Radials.³⁰⁷ Our disciplinary limitations do not allow us to offer views on its technical proposals, but as such, the concerns voiced here require resolution, whether as suggested or otherwise, to support a culture of public and transparent reasoning in collective matters, to allow for the unhindered development of the radials. This ethic is key to Auroville's long-term governance future.

We were not able to locate planning documents that have considered this proposal, to accept or reject it, other than Feduchi's draft Development Plan for Sectors 1 and 2 of the Residential Zone which incorporates its findings.³⁰⁸ Again, an environmental audit may be considered to allow for an informed debate on the concerns outlined, and consider any alternate design solutions. In particular, the study raises nine concerns that appear to be yet unresolved, in our conversations with members of planning groups. We list them here for ease of reference:

- i. The radial between Sector 1 of the Residential Zone and the Gaia Park invites bypass traffic from the outer ring road, and is located on a high percolation area.
- ii. The location and point of intersection between the Radial linking Sectors 1 and 2 with the Outer Ring Road is located on a fragile point of convergence of the extracted flow area; it is suggested that the road will increase erosion as it will act as a water flow collector channel. Accordingly, the study recommends shifting the road in Sectors 1 and 2 to make it into an internal distributor with development on both sides to mute the flow of traffic; in addition, it suggests that this radial needs to be buffered with a shelter belt plantation along the southern edge to manage surface and roof run-off, and advises the creation of water catchment tanks by

³⁰⁷ Land Suitability and Land Use Proposal, 2014, 23-29.

³⁰⁸ Feduchi, 2014, 39-41.

enhancing the natural depressions at the merging point of the extracted flows. These interventions, the study suggests, will create unique urban landscaped spaces for the settlements in Sectors 1 and 2.

- iii. The radial between Sectors 4 and 5, is sub-optimally placed in relation to the surface water flow, existing forests and the head of the canyon of Aurodam – accordingly, this radial should either be shifted or discontinued (the compatibility of the first suggestion with the symbolism of the Galaxy, perhaps with creative solutions to allow for a pedestrian, light movement radial may be explored here). This issue was also pointed out by the Planning Group in 2006.³⁰⁹
- iv. The study suggests a reconsideration of the service node at the point of intersection between the radial on the periphery of Sector 1 and the Outer Ring to preserve the Samridhi forest.
- v. The study notes that the radial between sector 5 and the park that buffers the International Zone is located over an ecologically sensitive area and limits the opportunity of residents in this area to access a natural land feature that could enhance their quality of life. Furthermore, this radial, like the radial mentioned in Point 2, cuts off the development's access to the park while being singly loaded, inviting bypass traffic. The study offers suggestion to resolve these concerns whilst maintaining the overall layout of the sectors.
- vi. In relation to the radial marking the northern edge of the International Zone, the study notes that it may invite squatting as it is in the vicinity of the village of Bharatipuram, populated by people squatting on *peromboke* lands without ownership documents.
- vii. The radial in sector 5 is supposed to have a link at a point over a canyon identified in the proposal to provide the main entry point for the International Zone. The study notes that this be detrimental to the green buffer that segregates the two zones, and would require extensive barriers to prevent spillover of the external tourist/service traffic into the Residential Zone and the green area. Instead, it notes that this canyon and the green buffer should be integrated as a restricted access green area to increase the water holding capacity of the soil here.
- viii. The proposal suggests margining the Outer Ring Road on the Western Edge of the Pony Farm, as it is a low-lying area ideal for water catchment.
- ix. The proposal notes that the location of the radial bordering the Cultural Zone cuts through the forests of Revelation – Minati, adversely affecting the biodiverse edges of the forests; it accordingly suggests that the radial be shifted near the Revelation

³⁰⁹ Planning Group, 2006, 21.

– Minati forest, and converted it into an internal distributor within the educational campus backing on to the Revelation forest, making this area a protected area with limited access.

Resolving these concerns is an urgent task that must *precede* development with a commonly agreed action plan to avoid subsequent disagreements, which given past records is likely.

x. Contemporary Governance Concerns

In sum, while our consideration of the technical and design details proposed in the Dreamweaving initiative, and indeed earlier planning documents, is limited, it is apparent that materially speaking, the magnitude, scale and density of Mother’s vision – the ‘city’ – is yet to be built. In many key sectors, work is yet to start. The inordinate delays in the finalization of a DDP since 2001 reflects chronic governance concerns. For example, in January, 1997, Auroville Today noted the ‘lack of planning’ and ‘lack of an enforcing authority’ as factors that ‘frustrate town-planning and development’ – twenty-five years on, the same holds true. Despite substantial on-paper movement, there appears to be a disabling environment for action, in terms of manifesting the form of the Galaxy or urban infrastructure development generally. We identify key concerns, with brief reflections:

- i. An insufficient awareness of Mother’s urban vision or the urgency of its manifestation.
- ii. A resistant shift from the environmental ethic of the first phase of Auroville’s growth to a balanced urbanism, resulting in a reluctance to infrastructure development, particularly in relation to the Galaxy form. Prolonged gridlock in relation to particular environmental hotspots.
- iii. A weak understanding of the Masterplan, its development proposals and planning strategy, in the community.
- iv. Altered incentive structures to develop and build, with a resistance to increased densities.
- v. Working Group selection processes insufficiently reflective of competence and expertise, with internal capacity constraints in key professional disciplines and a reluctance to engage external consultants.
- vi. Dissipated or uncoordinated local, zonal and sub-zonal organization, with a conflation of legislative and executive functions, insufficient centralization of authority and weakly defined enforcement mechanisms.
- vii. Unstructured participatory processes, without clear decision-making parameters in terms of format, effective harnessing of views or timelines, with the aspiration to consensus often translating into a veto.
- viii. A prolonged reluctance to planned development in preference for ‘organic’, but in reality, unsystematic, patterns of growth.
- ix. A lack of accountability mechanisms across legislative and executive domains.

- x. Financial concerns, given under-capitalization of the commercial sector and an over-dependence on fluctuating external sources that carry institutional risks.

The lack of intensity in the years since the Masterplan to manifest the urban infrastructure of the city or the Galaxy form is worrying, with various opportunities for growth missed in the process. In this, the absence of a cohesive planning strategy, with a DPP still to be drafted, has resulted in haphazard, *ad hoc* development driven by individual enterprise. This has led, as the Ford Foundation letter anticipated, to a gradual dissipation of energies with repeated aborted attempts to translate plans into action leading to a frustration amongst many residents, particularly professionals and those who took a leadership role in the sector. This scattering of the collective vision is accompanied by a marked decrease in participation in community fora. Worryingly, there also appears to be a gradual dimming of the ambition over the years, with various proposals and five years plan from 2001 onwards with progressively lower targets, given repeated concerns with implementation and a lack of urgency in the community – records from the 1970/80s anticipated 25-30,000 residents by the turn of the millennium, the 2001 Masterplan anticipated 15,000 residents by 2010, the Land Suitability and Land Use Proposal suggested 13,000 residents by 2013, with the ADP-2013 and IDPP proposing an increase to 5000 by 2018.

Looking at the planning history, ineffective executive powers and weak community processes, with accountability concerns on both sides, emerge as key concerns. These reflect patterns elsewhere, that Auroville must consciously transform going forward:

It is widely debated that ‘master plans’ of cities become static and do not adapt to the continuous social and economic changes taking place in the cities and their peripheries. They are seldom broken down into simpler implementable projects that can be budgeted for in a sequential manner. Even if that is done, in several cases it is too little or too late. In the meantime, lands are illegally subdivided and unauthorised constructions start deteriorating the urban landscape. It is also critiqued, that many Indian cities face issues like traffic congestion, pollution, flooding, and inefficient waste management, despite having ‘master plans’ in place.

Lack of implementation of master plans is also a widely raised issue. They often get stuck in disputes and scepticism. There is a perceptible communication gap between the plans and the people. There are limiting factors on both ends. On one hand, the planning agencies engage with the citizens in plan preparation process in a very limited way. On the other hand, the level of literacy, lack of awareness about the principles of planning (like common interest above individual interests), and lack of understanding of complex maps/master-plan reports are some of the factors that limit the effective participation by the citizens.³¹⁰

In instances where detailed proposals or plans were developed, as in the 2003 Directions for Growth Report, ADP-2013, the Land Suitability and Land Proposal Use, ISP, IDPP, Feduchi and others, the executive mandate of the Working Groups was either insufficiently strong to allow for implementation, or indeed, unaccountable as in many cases, Working Groups have not set or been set performance benchmarks to measure work. This is compounded by internal capacity constraints, with limited professional profiles in urban planning and allied sectors.

³¹⁰ Niti Aayog, 2021, 79.

The slow rate of population growth has limited the inflow of expertise in areas that are under-capacitated. The current selection processes – which we discuss in Part IV.B – operate on popularity and are insufficiently linked to expertise, experience or qualifications. In some instances, this has led to ‘committee-packing’, with weak action, either by design or by default. Alongside, there appears to be a reluctance to external expertise, with various suggested plans and proposals, including by Mr. Doshi, lapsing in time, leading to concerns of insularity.

Financial concerns are also apparent, though not the primary roadblock. Auroville’s funding potential, we may safely say, far exceeds its current absorption capacity. Absent some consistent support through Stichting de Zaaier and the Asia Urbs project, fundraising efforts have been scattered, unable to leverage Auroville’s full potential, particularly given collective visioning and implementation concerns that impede the flow of fresh funding. Utilization metrics for monitoring and evaluation of funds remains uncertain as well, and carries significant reputational risks that may dent fundraising potential. Looking to the future, however, structural concerns in the commercial sector will require attention to minimize dependence on external grants and donations, as we discuss in Part III.F.

In sum, there appear to be four species of concern:

- i. *Vision*: a resistant shift from the first phase of environmental regeneration to sustainable, high-density city-building, with a sidelining of city-development work, particularly key elements of the Galaxy.
- ii. *Organization*: weak processes for decision-making in the legislative fora of the Residents’ Assembly, ineffective implementation practices in the executive fora of the Working Groups, and an insufficiently organized community frame across the zones, with weak centralization / representation and an unspecified division of powers and duties across the three domains, leading to accountability concerns.
- iii. *Funding*: insufficient surplus generation in the commercial sector, leading to an unhealthy overdependence on external grants, with uncertain evaluation and monitoring mechanisms.
- iv. *Disabling Collective Processes*: a growing distrust, disillusionment and exhaustion in the community process, owing to direction-less and repetitive participatory practices and the perceived opacity of Working Groups eroding trust. The 2022 Dreamweavers forum, we may underscore, was a promising exception to the trend – though it did not fructify, it can serve as a valuable model for the future.

xi. Governance and Development Priorities

Based on our overview, we address governance and development priorities, incorporating suggestions made in previous studies where relevant.

a. A Call to the Future

The core concern that emerges from our review is the need to push to the future – to embrace and innovate an urban space, one that is dense and spiritually enlivening, dynamic and still. Amidst the intense planning work, with a raft of expert-led studies and participatory processes,

in part welcoming and in part resistant, Auroville is yet to engage with the vision of spiritual urbanism at scale, of which the form of the Galaxy is one, yet by no means, only manifestation. Worryingly, the concerns appear chronic. A recasting of the debate is thus necessary from the entrenched and tiresome rhythms of the past to the possibilities of the future, for the descent of a new form of life in space. The issue to consider is not primarily one of institutional reforms or enhanced participatory frameworks, far less sterile talk of high principle, but rather the urgency of the embrace, to hasten the advent of the New Creation in the urban form. Interestingly, when Mother was met with passionate pleas for democracy from Anger's friend Braslawski, who helped translate her symbol into the Galaxy concept, Mother replied: 'it would be better to build the city first!'³¹¹ It is this disarming sentiment, a call to action, that must guide works today, with which institutional concerns may be naturally resolved iteratively in the process: as elsewhere, the inner dictates the outer.

As we discussed in Part II, the 'city' is not just concrete and mortar, but an evolutionary spatial form in which the concentrated evolution, leading to the emergence of a gnostic society, may occur: developing a spiritual 'city', therefore, is part of the material *raison d'être* of Auroville and not a coincidental or supplementary occurrence. Mother's arrangement of her powers into the four zones of the city – a spatial arrangement of the spiritual – casts an imperative to raise the urban in all its aspects – cosmopolitan, productive, intellectual and social – to the Divine, for the form 'from far beatitudes' to near, the 'marvel of the descent ... changing to rapture the dull earthly round.'³¹² Our suggestions here address a far more modest, and in the final analysis, incidental need to secure an institutional architecture that may allow for energies to focus on this call to the future, the one true need:

Her aspiration called high density down;
A silent warrior placed in her city of strength
Inviolable, guarding Truth's diamond throne.³¹³

Our review of urban infrastructure development above, the material body of Auroville, elides the spiritual heart that animates this exercise. The tangible metrics, of accountability to targets, may be measured and indeed, are important to ground this exercise – our review speaks clearly of the need for a renewed sense of urgency, a collaborative aspiration to manifest the new urban form, at scale and density, not despite but because of the challenges that it brings. In this, Auroville will need a new language, a new form and a new way of life, generated progressively in the intense exchange of a scaled up and concentrated collective, in a spirit of exploration and joy, 'careless and divine'.³¹⁴ The pressing pace of urbanism globally, with its epochal opportunities and challenges, a deepening of the evolutionary stress that animated the works of Sri Aurobindo and Mother, demands action from Auroville *today*. Emerging literature in the new urban science points to these possibilities, a call for Auroville to be true to purpose – 'the

³¹¹ Guigan, 2018, Vol. 1, 161.

³¹² Sri Aurobindo, CWSA, 1997, Vols. 33-34, 4, 14.

³¹³ Sri Aurobindo, CWSA, 1997, Vols. 33-34, 357.

³¹⁴ Sri Aurobindo, CWSA, 1997, Vols. 33-34, 390.

creation of a city like Auroville has more weight in the earth's history than all the groups of the world'.³¹⁵

b. Governance Restructure

It is interesting to note that most of the problems reflected in Sri Aurobindo and Mother's discussion on the appropriate organization of a polity, the subject of our study in Part I, are reflected in the urban planning landscape: a rejection of planning with a desire for spontaneity, leading to *tamas*; the technocratic-democratic tussle, with the levelling-down problems of democracy manifesting in delays absent consensus, in tension with efficiency and implementation concerns; a resistance to rationalization borne of vital subjectivism disguised with a rhetorical appeal to supra-rationalism; concentration of powers in democratic channels, with interest-groups in the town planning landscape, each inspired by a partial idea in competition with others; the *rajasic* instinct manifesting in *de facto* ownership and possession patterns, with reluctance to admit new residents; *de facto* ownership; relative disorganization at the collective level across zones, inspired by a negative reaction to regulatory control, with appropriate correctives for centralization nascent now; the perils of participatory democratic models with low levels of awareness and education in the community on the Masterplan and subsequent planning exercises. We attempt a closer mapping of Sri Aurobindo's socio-political thought to these concerns, reflected across sectors, to suggest governance reforms in Part IV. Insofar as urban planning is concerned, the following points may be considered.

First, policy and organizational discontinuity, with limited institutional memory: over the years, multiple agencies have been tasked with planning in Auroville. The Auroville Town Planning Office that functioned between 2004-2007, gave way to L'Avenir D'Auroville, a 10-member constituted by the Governing Board that was operational till 2010. Post 2010, the 15-member Auroville Town Development Council was formally constituted by a Standing Order in 2011, reconstituted by the Residents' Assembly under its TOR in 2017, and subsequently revised by the Governing Board by its Standing Order in 2019. Alongside, the TDC constituted four Zonal Groups in 2004, an Advisory Group from 2011-2014, the Village Development Committees in 2018, a Work Allocation Team to ensure construction works are properly documented and monitored in 2011 and the Interface Team (selected by the community) and Technical Team (set up by Interface Team for evaluation and monitoring of Building and Infrastructure projects) in 2018 under the TOR. This regular change in the institutional architecture has led, by many accounts, to an unstable decision-making process with lack of clarity on powers and responsibilities. Equally, with short terms of three years under the 2022 Selection Guidelines, concerns remain with organizational discontinuity. The work done by an agency (or each team member) during their tenure is often not documented for follow-up, leading to an over-dependence on private initiative and contacts. The storage of work undertaken by each planning agency through the years is not exhaustive, nor available on a common, readily accessible database. Further, absent a formal handover process on a change of members, there seems to be a policy discontinuity: this disrupts the transfer of important learnings on projects undertaken thereby leading to an avoidable duplication of work and errors. As we propose in

³¹⁵ Guigan, 2018, Vol. 1, 215. Keith et. al., 2020; Brenner, 2019, Macdonald et. al., 2019.

Part IV, three administrative suggestions may be considered: a governance dashboard, an enterprise resource management system and an integrated data management service. Alongside, the term limits for TDC members may be increased from three to five years, with a defined handover process, rather than staggered replacements that break the team dynamic.

Second, internal restructuring and selection processes: urban planning is a professional domain, in that it requires technical expertise to make plans and to execute them. The members of Auroville’s planning agency are drawn from resident Aurovilians, with limited expertise in urban planning or allied sectors. As of 2007, Auroville has only one formally trained urban planner,³¹⁶ and as of 2023, to the best of our knowledge, there are two.³¹⁷ We accordingly propose a structure of the 2022 Selection Guidelines in IV to migrate from the anonymous, randomly-selected and popular selection system to a technocratic one that is consistent with the executive profile of the TDC. This relates to the broader, and critical, question of the role of the TDC vis-à-vis the community on one side and experts on the other – as we discussed above, the 2015-19 process of restructuring the TDC, building on similar exercises since 2005, presents strong reasons to rehaul governance systems insofar as city-planning is concerned. It is important to clarify the role of the TDC either as a planning body (with internal expertise) or a liaison between the community and planners (as in the 2017 restructure) – the TDC’s mandate reflected in the Standing Order of 2019 is vague and does not clarify this point, which has invited uncertainty in decision-making processes. Based on these factors, the TDC requires an institutional structure that is:

- i. *Stable*, given eight changes to the structure in thirteen years, and approximately twenty-two changes since 1965.
- ii. *Internally-defined*, with a clear distribution of roles / departments, with identified competences and selection as against those roles, as defined in the 2022 Capacity Building Plan, including a Chairman / Head, who may be individually accountable.
- iii. *Dual-track, with capacity building measures*, with an interface team (to clarify the TDC’s role as a liaison between the community and planners / experts) and a technical team, subject to internal capacity being available, absent which external expertise must be enlisted. The TDC’s role lies in community interface, program management / approvals and implementation-oversight, rather than technical work or actual execution. Selection for each track must thus be done accordingly, as against identified competences. Roy’s 2022 Capacity Building Plan suggests an organizational setup to this end that can be operationalized – staffing plans, resource requirement and mobilization plans and a workflow process, with defined time-limits for action at each stage, will require to be developed accordingly.³¹⁸ Roy’s plan does not refer to the interface / technical team distinction, but the five verticals

³¹⁶ Revi, 2007, 2.

³¹⁷ One of these two planners naturally noted in the 2022 Dreamweaving initiative noted that ‘integral planning as a skill and capacity is much needed for Auroville’. Dreamweaving the Crown, 2022, 17.

³¹⁸ Roy, 2022.

listed – Office Manager, Planning, Sustainable Development and Applied Research, Implementation and Monitoring and Legal Compliance – relate broadly to the functions of the Technical Team in the 2017 TOR. To this, we may suggest a sixth vertical for Interface Team, to be organized within that stream zonally (through the Zonal Groups) with two support personnel. To avoid further uncertainty and changes, this clarification / proposed amendment may be made to reconcile the two. For the technical team, with a limited group of planning professionals within Auroville, there is a ‘need to use a complementary external catalyst team.’³¹⁹ In the past, several domain experts – from Vastushilpa, Revi, Feduchi, Stein, teams leading the ISP, IDPP programs etc. – have extended their support in guiding Auroville’s development. As we discussed in Part IV.E, an assimilative and open ethic to invite domain experts to collaborate and assist in Auroville is in the spirit of Mother’s vision – Auroville must guard against an insularity that rejects external expertise. Accordingly, a public competitive process with defined qualifications and job descriptions to secure external consultants / expertise in strategy, planning and execution is required until the necessary internal expertise is generated.

- iv. *Competence-based*, with selection processes guided by defined professional qualifications and expertise (rather than popular vote), which requires a consideration of the Participatory Working Groups Selection Guidelines currently in place; with selection further contingent on defining a common work plan *prior* to appointment, as we discuss in Part IV, to validate workable group dynamics.
- v. *Participatory*, with robust processes for community engagement that are clearly defined (rather than *ad hoc* loose consultations), sub-zonal (to allow for informed and meaningful participation, rather than engaging the Residents’ Assembly for all matters) and time-bound (to avoid inflated, directionless community-engagement), yet *expert-driven and empowered*, in terms of decision-making in line with the principle of illumined hierarchies. Anger had highlighted this combination in 1968: ‘we have no intention of building arbitrarily. Not even one single area will conform to an exclusive architectural design. Many different teams must be at work and collaborate, each contributing very different expressions, under the coordination of a group empowered to unify this diversity.’³²⁰ It is important to emphasize that the competences of the Interface Team are to be carefully identified and cultivated – engaging community support to build consensus requires, as Fischer notes, ‘participatory expertise’, ‘a new kind of professional orientation ... that challenges the standard techno-bureaucratic approaches ... [to redesign] the role of a public manager as that of creating ‘communities of participation.’³²¹ Rather

³¹⁹ Rev, 2007, 2.

³²⁰ Anger, ‘=1’, 1968.

³²¹ Fischer, 468, in Levi-Faur (ed.), 2012. There is a flourishing literature on this issue, with a wealth of case studies and practical examples, that will be helpful to study as the Interface Team develops its own working practices. The importance of this task cannot be overestimated given Auroville unique social make-up and collective aspirations. See, Feldman and Khademian, 2007; Carpini et. al., 2004; Fischer, 2009; Fund and

than simply being a proxy representative or window between the experts and the community, the role of the Interface Team is crucial to translate the two languages and domains, of lived experience and technical expertise, to harness collective intelligence and secure movement. This is key for Auroville’s urban governance future for prudential as much as moral reasons.

- vi. *Implementation-oriented*, with strong executive powers to implement plans once community processes are duly engaged in the given time-frame, resting on a clear distinction between the legislative domain of the Residents’ Assembly (or as we propose in Part IV, Zonal Assemblies) and the executive domain of the TDC / appointed experts.
- vii. *Independently monitored and accountable*, by a Unity Committee and Steering Group, as we propose in Part IV, to resolve the concern of dual reporting to the Governing Board and Residents’ Assembly (with internal monitoring mechanisms within the TDC, as in Roy’s proposed structure).
- viii. *Well-advised*, by an ‘Advisory Group’, which in our proposals in Part IV acts both as an independent review body – with a channel to the Unity Committee, to ensure mid-term accountability of the TDC – and as a board of advisors.
- ix. *Administratively supported*, to ease the daily burden. Each member currently has to multi-task, drawing up professional plans, undertaking community consultations while also handling documentation and day-to-day administrative work, leaving little time for visioning and reflection. We propose an independent human resources and administration vertical in Part IV to this end, with mid-term capacity building measures. Roy’s 2022 Capacity Building Plan, yet to be implemented, offers solutions.
- x. *Data-driven*: the collection and management of quality data – discussed sectorally in subsequent sections – is essential for evidence-led planning and implementation in the future.³²² We propose an independent working group – the Data Service, or howsoever named – to professionally manage this task for all city services, alongside a Governance Dashboard and an integrated ERP. For the TDC, strong analytics, data-driven decision-making, monitoring and evaluation, visualizations etc. will be of particular importance. The flourishing global literature on this subject – at the intersection of sustainability science and urban science, leveraging data-intensive analytics – can be explored to design a solution suited to the TDC’s

Wright, 2003; Gastil and Levine, 2005; Malena, 2009; Osmani, 2007; Papaloulous and Warin, 2007; Rowe and Frewer, 2004.

³²² This matter was raised by Stichting De Zaaier, a major funder, in October, 2013 with a proposal for funding a statistics office. *See*, Auroville Today, January, 2015, 37. Interestingly, Mother’s 1969 Ford Foundation Letter also anticipated the preparation of ‘software for integrated data systems’ and a ‘data system collection and processing plan.’ Ford Foundation Letter, 1969, 6-8.

needs.³²³ The recent MOU with the Centre for Development of Advanced Computing is a positive move in this direction.

Third, systems engineering / complex adaptive planning through inter-group linkage: the work of the TDC comprises both physical and socio-economic planning, thus placing it at the intersection of various processes. Yet, the process links and approvals processes between the TDC and various both in respect of common actions that overlap as per their written mandates is not clearly defined, leading to inefficiency: FAMC (in respect to economic planning), Land Group (in respect of land maintenance, effective utilization, strategies to acquire development rights to un-owned lands), Housing Service (in respect of housing maintenance, plans to build new housing), Zonal Groups (in respect of preparing Detailed Development Plans for each Zone), Green Group (in respect of preventing non-harmonious development in the Green Belt, food security planning), Auroville Village Action Group (in respect of outreach and village relations, including Village Development Plans), Working Committee (in respect of fundraising for infrastructure works, government liaison), Auroville Council (in respect of planning disagreements in the community), research centers like the Auroville Centre for Urban Research, Integral Sustainability Initiative, Auroville Earth Institute (in respect of leveraging internal expertise in urban planning and allied fields), SAIER (in respect of infrastructure planning for Auroville's future educational needs), Auroville Board of Services and Commerce (in respect of infrastructure planning for Auroville's future economic and industrial needs) etc. This lack of specification has led to avoidable uncertainty and inefficiency. We consider this in Part IV to propose (i) a restructuring of the mandate of the TDC / FAMC, (ii) with independent sub-bodies with more manageable and clearly defined mandates to avoid overlap and bolster accountability, and (iii) where necessary, a defined process for common sittings, (iv) a strengthening of the Zonal Groups to allow for robust, yet time-bound, community interaction and zonal planning, with (v) representatives of the Zonal Groups as *ex officio* members on the TDC for effective co-ordination. Back in 1968, Mother's 'systems engineering approach' in the Ford Foundation letter had anticipated 'trade off studies' to 'determine the most suitable subsystem from a host of alternatives', identification of the 'objectives and constraints' of each sub-system with a determination of the 'relationship between different subsystems' – learnings

³²³ See, Ministry of Housing and Urban Affairs, 2022; OCED, 2023; Barns, 2018; Wang et. al., 2021; World Economic Forum, Ministry of Housing and Urban Affairs, Government of India and Deloitte, 2020, 13-15; Farmanbar and Rong, 2020. See, Bibri, 2020, 88, *in passim* for a state-of-the-art review of intelligent urbanism ('The role of innovative ICT-enabled solutions in advancing urban sustainability is becoming evident in the light of the rapidly evolving theoretical and practical work concerned with the integration of sustainable cities and smart cities in a variety of ways. The need for advanced ICT in its various forms to be embedded into and pervade the built environment is underpinned by the recognition that urban sustainability applications are of high relevance and importance to the research agenda of computing and ICT, especially big data science and analytics. To unlock and exploit the underlying potential, the field of sustainable urbanism needs to extend its boundaries and broaden its horizons beyond the ambit of the built form and ecological design of cities to include technological innovation opportunities and data analytics/ computational capabilities. Besides, sustainable urbanism is a complex issue, with myriad problems surrounding urban systems. This is coupled with sustainable cities facing unprecedented physical, environmental, economic, and social challenges pertaining to urbanization. Therefore, sustainable cities are embracing the advanced forms of ICT, notably big data technology and its novel applications, to turn themselves into smart sustainable cities. Indeed, a new era is presently unfolding wherein smart sustainable urbanism is increasingly becoming data-driven.')

from the literature in complex adaptive systems today can be leveraged to develop a well-defined system for necessarily interlinked tasks within the mandate of the TDC.

Fourth, institutionalizing time-bound and structured sub-zonal consultative processes / resolving technocratic-democratic tensions: community-informed and community-led decision-making is at the heart of Auroville's development. As we consider in Part IV, the culture of small-group democracy has led to a loosely defined network of semi-autarchic nodes, with no cohesive governance frame to reach collectively-agreed upon targets to take forward implementation. Low levels of awareness and engagement with various expert-driven studies, even in cases where the robust participatory models were developed, as in the ISP, ADP-2013, 2015 Retreat, indicate insufficient self-regulation and cohesiveness within the community even when 'bottom-up' approaches were employed. Whether as an inability to effectively self-organize or a strategic move to filibuster implementation, a recalibration of community engagement methods is necessary. The twin concerns of participation and efficiency will dictate the healthy functioning of Auroville's urban aspiration, a dynamic explored with reference to Sri Aurobindo in Part I – as such, the variable quality of participation and delays in efficient implementation require work to institute both time-bound participation in drawing up plans and clear implementation benchmarks to against which Working Groups can function to allow for accountability on *both* sides. Accordingly, we propose in Part IV, a representative Residents' Assembly for city-wide planning measures, with Zonal Assemblies for zonal planning measures, both functioning as legislative bodies for policy matters, and an independent, strong executive mandate for Working Groups and Zonal Bodies to implement policies in a defined time frame with appointment contingent on development of work plans prior to selection, not after. Alongside, we propose a firm sub-zonal institutional setup to allow for meaningful and effective participation at the local level, rather than a cumbersome 'direct democratic' setup at-scale in the Residents' Assembly. This may go some way to resolve the concern in ADP-2013 that the TDC has faced 'difficulty (in) harness(ing) residents support to embark on action-oriented planning practices and a collaborative governance system.'³²⁴ While participation is key and such processes may have a longer than usual curve, it cannot be unduly prolonged as the records indicate.³²⁵ Community participation initiatives in Auroville have revealed a complex web of intangibles – fears with urbanization and increasing density, power concentrations in decision-making channels, variable levels of collective vision with altered incentive structures to join, insecurities over committing to planned development in preference to organic and spontaneous action, 'ideological' divides across closed groups, personality clashes etc.. These are, as we discussed in Part I.B, natural, if troubling, developments in the polity as it transitions from infra-rational modes of being; as we suggest in Part IV.A, a well-defined Zonal and sub-Zonal architecture can generate institutional headwinds to hasten this movement, with an opportunity to build a robust, locally active community process of decision-making – in defined time-frames, as against which accountability can be ensured – tied into clear executive mandates to implement at the conclusion of that time-bound process.

³²⁴ TDC Annual Development Plan, 2014-15, 10.

³²⁵ See, for example, views on this point, representative of those expressed in our interviews, Residents' Assembly General Meeting, 2022, 21-22.

Participation in smaller aggregates is more effective, likely to generate consensus and avoid spill-over effects of disagreement in one sector or domain to all others.

For this, the Planning Portal of the proposed Governance Dashboard may be developed with community-wise (sub-zonal) and zone-wise pages, as a single-window platform for information on proposed plans, feedback, engagement and feedback processes and digitized site and construction approvals / permits / NOC processes that are standard, self-certified and automated as far as possible. A range of innovative efforts in this direction, for digital and physical engagement, can be explored for integration to enhance quality and easy participation – these include visualizations, simulations and augmented reality setups, fuzzy cognitive maps and explainers for reports / studies, with automated translation services, a digital library of expert-led videos for asynchronous consumption, skills-training for facilitated deliberation (as in the 2021 Citizens’ Assembly Pilot), virtual town halls (for example, Mind Mixer), webGIS and Urban API solutions etc.³²⁶ As we propose in Part IV, the organization of Auroville in a firm sub-zonal architecture, with defined communities and representation along the trustee-delegate model from each, is necessary for meaningful engagement at the ‘local’ level – in our proposal, the Zonal Groups, with *ex officio* membership in the TDC Interface Team, can anchor this work of participation, relying on an appropriate use of digital solutions alongside physical community meetings in these *smaller* aggregates. Research on participatory urban planning points to the need to locate participation at the neighbourhood / local level to meaningfully harness collective intelligence and avoid the logistical, emotional and cognitive burdens of participation at scale.³²⁷ A structured and defined participatory process is necessary for this purpose, particularly given the historical record in Auroville.

Fifth, performance benchmarks, monitoring and accountability: aside from the TDC-13, we were not able to locate any other plans with clear performance benchmarks or budget / personnel outlays. This is a minimum requirement for effective work and to ensure accountability. As we propose in Part IV, selection to the TDC must be *contingent* on a work plan commonly agreed upon by selected members for the duration of the residents’ term to settle targets and test group dynamics prior to selection as far as possible, with a two-tiered evaluation and monitoring system, internally to the Unity Committee and externally to the Steering Group, comprising members of the three statutory bodies. We discuss these in Part IV.

Sixth, research focus: as a city dedicated to research, Auroville requires a robust institutional frame for applied and theoretical research in urban planning and allied disciplines. This is both to secure a talent-base of planners, mobility experts and others for city-building, and to serve the country with educational / professional opportunities drawing from its experience. As we noted above, the shortage of qualified professionals has hampered city-building works – for

³²⁶ There is a wealth of literature on this subject, with which Auroville’s Interface Team and Zonal Groups can engage in their own design. See, UN Habitat, 2001, 113-4; Münster et. al., 2017; Geertman and Stillwell, 2003; Haklay et. al., 2018; Tata Centre, 2018; Stauskis, 2014; Saßmannshausen et. al., 2021; Mougiakou et. al., 2020; MindMixer, 2022; Khan et. al., 2020; Brennecke, 2023.

³²⁷ We discuss the question of at-scale participation, i.e., for all matters to be discussed in the Residents’ Assembly, or with the ‘community as a whole’, in Part IV.

the medium-term, it is important to focus on (i) programmatic interventions to attract professionally trained newcomers through targeted outreach in leading universities and practitioner circles; (ii) capacity building plans and a professional training / educational setup for the youth to build internal expertise in urban planning and allied disciplines, particularly given the lack of opportunities for professional training within Auroville currently. Developing a research infrastructure will require a dedicated and independent faculty body outside the TDC. This can in time develop into a leading centre for research in urban planning and allied fields, embedded into the free-progress, tertiary research framework proposed in Part III.E. The Niti Aayog's 2021 report on urban planning capacity points to pathways for model curricula and strengthening of centers of education – this is an area in which Auroville is uniquely situated to contribute its experience, whilst generating a meaningful source of income and developing talent to serve its own planning needs.³²⁸

Seventh, vision, urgency and mindset changes: the general awareness of the Masterplan, subsequent planning documents or indeed, Mother's words – all pointing to a high density yet ecologically rich urban landscape – seems to be low in the community, resulting in a diminishing intensity over the years to manifest key urban infrastructure, including the Crown, industry, mobility systems etc. and strategic plans for incremental population increases. The progressive dilution of the vision – with a tense shift from the environmental growth in the first phase to a vision of sustainable urbanism as the second – is recorded in some detail in the 2015 Retreat and continues to be a concern. As we discuss in Part IV.E, the dimming of the pioneering energy with time is a natural and expected occurrence that the community must guard against with an active and engaged public sphere – a *sine qua non* for Auroville's collective life, currently dissipated and fractured – that invites residents', particularly newcomers, to reflect and act on Mother's account of spiritual urbanism.³²⁹ Introducing this theme in Auroville's education curriculum may be a useful step to ensure that the recalcitrant divides of the last two decades do not transfer, with a more informed dialogue going forward.

In sum, we note that the Masterplan is due for review in 2025, and many have called for this process to be expedited. While such a periodical review is helpful to account for changed circumstances, revising or preparing a new Masterplan will not be a meaningful exercise unless the causes of limited to no uptake of the previous plan are resolved. A similar fate must not follow for any new planning frameworks. Before more reports and studies are commissioned, or a formal review of the Masterplan begins, it may be well-advised to resolve these concerns.

³²⁸ Niti Aayog, 2021, 66-77, 90-2, 96-7.

³²⁹ In general, the depth and urgency of town planning in the early years is remarkable, in contrast to later decades. See, for example, An Evolutionary Approach to the Development of Auroville, 1972; Auroville First Phase of Development 1969 – 1974; Auroville on the Move: First Realisation, n.d.; Auroville Planning Group, General Report, 1972; Auroville Progress Report, 1969; Dutch Participation 1968-1981, n.d.; Mother's View on International Zone, n.d.; Notes from Shri Aurobindo's and Mother's Writing on Concept of Auroville, n.d.; Planning Early Years 1968-1974, n.d.; Planning early years: Auroville as an expression of Auroville and Aurovilians, n.d.; Planning Early Years: Before Inauguration and After Up to 1971, n.d.; Planning: Auroville Town of Fraternity, n.d.; Ramanathan and Poddar, n.d.; Jyoti, n.d.; Vardharajan, n.d.; Architecture and Urban Design, n.d.

b. Development Priorities

Given our review, we identify discrete development priorities below that may precede / assist a planning review.

1. Crown, City Centre and Mobility

1. Marking of rights of way, with agreement on placement and width, and laying down of the infrastructure corridor as per the 2012 Infrastructure General Layout Design, on the Crown and Radials with a comprehensive environmental audit to assess Auroville's long-term environmental sustainability.
2. Identify, and peacefully remove, deliberate non-harmonious constructions in a time-frame; identify sites for re-housing / resettlement for non-deliberate constructions that require removal; draft a resettlement policy.
3. Revisit the output of the 2022 Dreamweaving Process, with Vastushilpa Consultants; develop a Crown Development Plan as a pre-requisite to clearing / construction; easy-access compilation of all historical records pertaining to the Crown for public awareness.
4. Time-bound finalization of the 2007 City Centre Proposal, after review and time-bound consultations.
5. Resolve concerns / consider proposals in Land Suitability and Land Use Proposal, 2014 to integrate Radials with ground realities in sensitive areas.
6. Conduct a mobility systems analysis and design, with studies identified in Revi, 2007, anticipated in Mother's 1968 Ford Foundation Letter; develop a mobility plan with reference to Auroville's Future, 2005, the 2022 Mobility Study; consider an independent cell for mobility / flow planning within the ACUR / research frame suggested above.
7. Focus on four time-bound acupuncture projects on the Crown, as more than a road, with zonal Detailed Development Plans to follow in a period of 6 months / 1 year; identify priority development and phasing targets in line with the IDPP, 2014.
8. Time-bound development of Line of Force 1, reviving the Line of Goodwill project; conduct density studies for Lines of Force with future studies for expected socio-economic profile, with time-bound preparation of feasibility studies / development plan.

2. Development Plans and Zonal Strengthening

1. Clarify mandates and powers of Zonal Groups, with appropriate devolution and time-bound preparation of Zonal Detailed Development Plans, including phased population increase targets (with an anticipated population profile, that can guide the work of the Entry Service and strategic outreach) and identification of social and physical infrastructure; define the role of nodal agencies in each zone (SAIIR for the Cultural Zone, Housing Service for the Residential Zone, Auroville Board of Commerce for the Industrial Zone etc.) to strengthen the sub-zonal consultative process.
2. Develop a Detailed Development Plan for Residential Zone Sectors 1 and 2, with Feduchi, 2013, as a template; for the International Zone, with the 2018 Strategic Plan, as a template; define national / continental cluster boundaries, architectural and urban parameters identified including layers of priority, NZEB compliance practices; identify 'green corridors'; time-bound plans for Industrial Zone and Cultural Zone, the latter with a focus on the Education Loop, with SAIIR as the nodal sub-zonal body.
3. Definition of aesthetic and performance standards for the 'city' and building an appropriate pattern language for building the city; finalize Urban Design Guidelines, 2010; refine, finalize 2013 draft Building Guidelines by TDC / Eveleigh.
4. Inventory archaeological and heritage features; develop policy to excavate archaeologically sensitive areas in a time-bound manner, as suggested in the 2014 Land Suitability Proposal.
5. Set ideal density markers across zones, with no new permits for residential construction outside the Masterplan area / phased plan for relocation to the Residential Zone.
6. Define a concrete sub-zonal structure (neighborhoods, wards, sectors), for regular harnessing of community input.
7. Identification of location of Continental Clusters and National Pavilions, creation of an International Zone Group / Working Committee / Town Development Council joint-body, with executive mandate to sign and execute MOUs with consulates / foreign governments; liaison development with the Ministry of External Affairs. Develop standard / draft MOUs to offer universities for discrete learning / research centres where relatively easier funding potential lies, with a defined IZ-research publication agenda along the lines of the Project for History of Civilizations.
8. Complete excavations in the International Zone in a defined time-frame, to allow for planned developments; consider the placement of an archaeology research centre for the International Zone Development Plan to allow for integration, as suggested in the 2014 Land Suitability and Land Use Proposal.

3. Community Participation Processes

1. Develop structured process-maps for community-participation models at the Zonal, sub-zonal levels for the TDC Interface Team; develop a digital consultation portal, integrated with the Governance Dashboard, for updates and to harness regular feedback. Draft easy access materials / explainers / handbooks for general awareness on city-planning, including Masterplan, expert studies etc., to allow for informed participation. Explore visualizations, simulations and augmented reality setups, fuzzy cognitive maps and explainers for reports, studies etc., with automated translation services, a digital library of expert-led videos for asynchronous consumption, skills-training for facilitated deliberation (as in the 2021 Citizens' Assembly Pilot), virtual town halls (for example, Mind Mixer), webGIS and Urban API solutions, 'consensus conferences' etc. Develop a city-wide digital learning platform (discussed in Part III.D below) in relation to urban planning issues, through the Auroville Campus Initiative / Citizens' Assembly / Univers-City initiatives for asynchronous learning.
2. Define timelines for community engagement, with an end-date and defined, binding outcomes once agreed. Attempt consensus, but without *de facto* veto powers.
3. Clarify the legislative / executive boundary as between the Residents' Assembly / Zonal Assemblies and the Zonal Groups / TDC – particularly, defined mandate for (i) drafting of plans by external consultant / Technical Team, with community consultation *only* through Interface Team to avoid multiple channels, leading to (ii) legislative approval of Zonal Development Plans by Zonal Assembly in a defined time-frame, with (iii) executive approval and implementation of Layout Plans by the Technical Team (with Zonal Group *ex officio* membership) to balance concerns. All processes, with associated documentation, including draft plans, minutes, studies etc., to be channeled through the Governance Dashboard.
4. Develop a module of Auroville's urban aspirations for newcomers / new residents to allow for alignment.
5. Develop awareness programs, with SAIIR, on town-planning to be integrated in the curriculum of the Auroville and outreach schools, along with participation in live-action projects on the ground for experiential civic education. Regularize the Youth Forum (of the 2015 Retreat) for under-18 residents through YouthLink, for youth interface in planning through the TDC Interface Team.

4. Capacity Building, Internal Restructuring and Data Management

1. Harmonize Standing Order 1/2019 with the 2017 TDC-TOR; reinstitute Interface and Technical teams, with an independent Implementation Monitoring Team to oversee development works, with the development of a project management system, and quality assurance, monitoring and evaluation system.

2. Define internal departments within the Interface and Technical Teams, with identified competences, qualifications and experience requirements, particularly in relation to communications strategy; expert-drive, rather than popular-vote, selection process to be as against defined competences / JDs.
3. Develop an internal capacity building plan, with identified personnel and formal partnerships with external agencies for Technical Team training; internal capacity building plan for dedicated human resource / administrative support staff (in an independent city-wide Administrative Services vertical, proposed in Part IV); institutionalize a regular (five-yearly) audit of personnel and human resource capacities.
4. Clarify overlapping mandates between the TDC and FAMC, with dual-track TDC restructure and smaller mandates for each, defined subjects / processes for joint sittings (suggested in Part IV); restructure the TDC mandate to exclude socio-economic planning, given capacity constraints / heavy mandate, to be housed in an independent research-driven body; complex adaptive systems research for institutional design. Review, finalize Roy, 2022 with addition of an Interface Team; develop staffing, resource requirement and mobilization plans and workflow process.
5. Empanel architects, urban planners, mobility experts through an open competitive process; develop standard procurement and contract procedures; develop a vendor database and vendor development strategy.
6. Institute and as far as possible, automate online approvals for building applications / permissions / self-assessments / declarations / certifications.
7. Develop a single window Governance Dashboard for approvals / notifications / status updates on on-going work; develop an integrated data management system / ERP, for all work undertaken / status (whether complete or incomplete), annual plans / work plans, minutes of meetings / agenda documents, internal and external performance evaluations, performance benchmarks, commissioned reports / studies, with outcome measurement etc. Collate, digitize all existing studies, reports, surveys in the dashboard / data management portal (over 250, as per our records), with commissioning of new studies dependent on explicit identification of a gap to avoid duplication.
8. Restructure selection processes, to assess technical expertise / prior work experience, away from popular voting under the Participatory Selection of Working Group Guidelines; make selection provisional / contingent on submission of work plans with personnel requirements, budget estimates, performance benchmarks and time-lines, as proposed in Part IV; require deviation / changes from previous work plans to be justified, to ensure institutional continuity.

9. Operationalize the TDC Advisory Group, and institute termly reports as against work plans, for internal review by the Advisory Group / Unity Committee and external review by the Steering Group.
10. Define hand-over checklists and processes / staggered selection mechanisms for institutional continuity.

5. Research

1. Revive, expand, strengthen Auroville Centre for Urban Research, Sustainability Initiative, Energy Institute with full-time research / professorial roles attached; develop a five-yearly research agenda (multi-disciplinary, with partnerships / exchanges with leading universities, School of Planning and Architecture, Indian Institute of Human Settlements, Massachusetts Institute of Technology, Queen's University and others globally, with existing links to Auroville); study feasibility of a School of Urban Planning, for embedded learning, with doctoral / post-doctoral programmes;
2. Regularize the Auroville Board of Architects and Urban Planners, to serve as faculty clusters.
3. Study feasibility of vocational courses / apprenticeships in architecture, urban planning and allied disciplines, with certification from Pondicherry University / other aligned universities.
4. Institute an academic-press standard, peer-reviewed Journal of Urban Studies led from Auroville.
5. Establish an independent Data and Statistics Centre, proposed in Part IV, to *inter alia* institute regular surveys for Auroville, including demographics, household and enterprise surveys, including employment where appropriate, key cultural resources etc. for evidence-led planning.
6. Explore digital twin modelling systems, for future urban development projects.

6. Funding

1. Prepare an overall project cost estimate, with budget outlays as mandatory part of work plans (on which selection is contingent); develop a city-wide fundraising strategy, with assistance of identified external experts to prepare grant proposals (as begun in Item 61.8 of the 61st meeting of the Governing Board), with mapping of available resources through Central / State Government schemes and private funding to pursue under-leveraged sources; study project and institutional finance opportunities;
2. Develop a single window fundraising platform to coordinate and streamline efforts.

3. Develop disbursement / funding policy for internal / external contractors, consultants, commissioned studies etc., with defined deliverables and review process; automate / digitize standard review processes; develop transparency guidelines for disbursement, evaluation; develop, standardize metrics to measure fund-utilization.

7. Data Gathering and Miscellaneous

1. Formulate a green building and infrastructure policy; create user-friendly Masterplan and planning guidelines.
2. Develop a coastal regulation and climate mitigation, adaption strategy; institutionalize yearly emissions reporting; examine Auroville's carbon sequestration capacity; examine feasibility of entering carbon credit markets.
3. Undertake a performance review as against the 2014 Electrical Master Plan / 2003 Municipal Energy Plan; develop the Auroville Mini Grid as proposed; complete transition from low to high tension cables; conduct an infrastructure systems design process, energy systems studies, leading to design, water analysis and design, identified in Revi, 2007; expand on the 2014 Integrated Surface Water Management Study for Residential Zone, Sectors 1 and 2, for the city, leading to a Water Resources Management Plan to regulate construction activity.
4. Conduct future assessment studies identified including those identified in Revi, 2007, not conducted based on records made available to us, for evidence-led planning projections; strategic global and Indian sustainability projections to 2050, strategic natural and manmade hazard risk analysis, futures studies on energy, mobility, water management, information and communication systems, futures studies on ecotechnology and ecological management systems, studies on the future of work, lifestyles, leisure, arts and culture (necessary in particular for the design of social infrastructure on the Crown and Lines of Force), future scenario development for the region and Auroville (detailed in the PVAC Report), demographic futures and resource footprint simulation.
5. Institute data collection practices for tourism in Auroville and the bio-region, particularly Pondicherry, for evidence-led planning, with action strategies outlined in the IDPP 2014, Tourism Management Framework, 2019 and Ayer et. al., 2019.
6. Prepare an inventory of existing public facilities in terms of capacity, utilization, functions, operational costs, to examine adaptive use of underutilized facilities (last conducted in 2014-15).
7. Security systems design, including 'Auroville Guard' / EMT training programmes (currently the under-resourced STTF), and external liaison protocols through the proposed security-channel in the Working Committee.

B. LAND ACQUISITION

i. Overview

The Masterplan delimits Auroville at 19.63 sq. km., with the ‘city’ area at a size of 5 sq. km. and the Green Belt at 15 sq. km. The majority of land purchase was made in the years between 1964-1973 in Mother’s presence when a total of 8 sq. km. of land was purchased. Henk and Manuel Thomas quote Ryckaert to paint a picture of land purchase in the pioneering years:

The first plot of land was bought on 8th October 1964, almost three and a half years before Auroville’s inauguration. Between 1964 and 1973 about 2,000 acres (816 hectares), spread over an area of 24 sq. km and interspersed between privately owned land and government land, were bought. The land looked desolate in those early days and its inhabitants poor and uneducated ... It was in this degraded socio-economic and environmental context that Auroville started buying land from local landowners. The land was purchased at fair market rates and through negotiation, without any coercion. With 90% of the rural population landless, most of the plots belonged to relatively wealthy village families, who used the income for the education of their children, building a second house, buying land outside the area or setting up a lucrative business.³³⁰

Between 1973-1999 only 2 sq. km. of land was procured across the city and Green Belt, with ‘almost no funding available for land purchase’.³³¹ AS a result, between 1964-2000, a total of approximately 10 sq. km. (50%) of land had been purchased. The mid to late 90s saw increasing concerns with land security owing to development in the bio-region, particularly in Pondicherry, with unchecked urbanization patterns in the bioregion. The 2001 Masterplan noted that as of August 2000, about 7.78 sq. km. was owned by Auroville in the designated township area. This included 4 sq. km. in the ‘city’ area (approximately 80%) and about 4 sq. km. in the Green Belt area (approximately 30%).³³² At the turn of the century, 50-90% of land was yet to be purchased, mostly in the Green Belt area.

Though progress had been made in land purchase for the ‘city’ area (with some parcels strategically held in private use), the year-on-year purchases were slow, hindered by limited financial resources and rising land prices, driven by speculative buying. Legally speaking, the Masterplan brings Auroville under the definition of public purpose under the Land Acquisition Act. However, the early prescription recorded in the 1999 Masterplan draft that ‘no displacement [of the villages] is intended’ led to a policy decision to avoid compulsory acquisition, even though references to this option are a constant refrain in the records.³³³ This preference for integrated development as against coercive land acquisition is in keeping with Mother’s early direction:

Auroville does not want to evict anybody from their houses. It is a gross error to say that people from eleven villages will be forcibly evicted. Fifty-two acres of land in

³³⁰ Thomas and Thomas, 2013, 61.

³³¹ Residents’ Assembly Masterplan, 1999, 60.

³³² Masterplan, 2001, 37; Auroville Land Situation, 2000.

³³³ Residents’ Assembly Masterplan, 1999, 60, 62.

Bommapalayam and eighty acres in Irumbai have been asked to be made available at reasonable rates.³³⁴

As part of the integrated approach, the 1999 Masterplan had also anticipated an Extended Area Partnership Plan ('EAPP') for the development of 40 sq. km. of villages, 'identified as critical ground water re-charge areas', within and around the township. The EAPP was to assist socio-economic development and 'maximize groundwater recharge' in these villages, thereby functioning also as a soft land protection strategy.³³⁵ The early records indicate a preference for collaborative development of villages with projects such as the EAPP (though not implemented subsequently) to strengthen material and cultural ties in relation to lands not owned by Auroville, obviating the need for forced acquisition. The acquisition of land thus conventionally took place by negotiated purchases, and was later expanded to include other modes – land donations/gifts, land exchanges and long-term leases. The Masterplan also suggested alternatives such as land for employment (economic development in surrounding villages by Auroville, in return for land offered at a reasonable price), leasing and land pooling. These practices however do not seem to have been deployed.

Given Auroville's own growth and the socio-economic development of the bio-region over the years, a felt need to secure and protect the physical base was reiterated since the mid-1990s: the acquisition of land had been accompanied by constantly rising land prices and the threat of encroachment or non-congruent development largely due to the urban and industrial expansion of neighboring Pondicherry and the surrounding bio-region. With the liberalization of the Indian economy, land prices in and around the Auroville region had 'skyrocketed by an exorbitant 1,150%' between 1989-1999 – activating alarm amongst some ('the house is on fire!') but with limited success in actual acquisition.³³⁶ As a result, by 2019, the total land acquired was 9 sq. km. (an increase of 1 sq. km. from 2001)

In the context of these threats to land security, two avenues have been pursued to safeguard lands. First, the Masterplan emerged less as a planning tool but more as an 'appeal to the Government of India, to take all possible steps to safeguard the land', a bid to ensure 'legal protection of the designated Auroville area from speculation and real estate development ...'³³⁷. Second, in 2003 the option of setting up a New Town Development Authority ('NTDA') as a regional planning body was offered to Auroville in collaboration with the Government of Tamil Nadu. Neither of these formal protection measure has yet been formalized, despite considerable discussion on both fronts.³³⁸ Particularly, Auroville's current population density at 1.3 person per hectare offers limited leverage to activate these measures, a point of concern that is under-appreciated in the records. We discuss the NTDA and other 'soft' options of land protection (memoranda of understanding with village panchayats, 'observer' status in the Regional Planning Authority etc.) in Part III.C.

³³⁴ Guigan, 2018, Vol. 2, 177.

³³⁵ Residents' Assembly Masterplan, 1999, 60-2.

³³⁶ Majumdar, 2017, 264.

³³⁷ Minutes of Residents' Assembly General Meeting, 1999, 2.

³³⁸ See, for example, Auroville Foundation Annual Report, 2008-9, 14; Auroville Foundation Annual Report, 2010-11, 91; Auroville Foundation Annual Report, 2012-13, 17; Auroville Foundation Annual Report, 2014-15, 16; Auroville Foundation Annual Report, 2018-9, 17.

Owing to these developments, two land policies were drafted in 1999 and 2011 that provided an internal institutional framework to facilitate the management of land in Auroville. Both versions of the land policy laid down rules for non-ownership and responsible stewardship, in line with Mother's vision. The ownership of all lands was vested in the Auroville Foundation, with management of lands assigned to the Funds and Assets Management Committee ('FAMC'). The Land and Estate Management (LEM) (or the Land Board at present) was to function as a sub-unit of the FAMC, aiding the maintenance of land records, allocation and re-allocation of stewardship, ensuring land protection and so on.

The institutional structure to deal with land matters, however, has varied considerably over the years: as far as we are aware, seven Working Groups / task-forces have been setup by the Governing Board and relevant Working Groups. The Land Use and Land Coordination Committee, working with the Planning Group, which drafted the 1999 draft Masterplan was the nodal body till 2005, with the Auroville Land Service preceding it in the 1980s. From 2005-2007, the Land Consolidation Committee ('LCC') and Land & Estate Management groups were established. Subsequently, from 2007-2014, the LCC was formally constituted by the Governing Board under Standing Order 2/2008, alongside the Land and Resources Management Committee ('LRMC'), though the precise division of work and powers is unclear in the records. In this period, two sub-groups were created – the Land Matters Task Force to accelerate the process of consolidating land holdings within the 'city'/Green Belt area and Lands for Auroville Unified ('LFAU') to arrange funds for land acquisition. Finally, in 2014, the Land Board was constituted by the Residents' Assembly with the advice of the Governing Board, whilst the LRMC was tasked with revenue generation through the sale of wood, cashew harvest and leasing.

In terms of the set up to fund land acquisition, the Land Fund was organized as a common pool to consolidate funds for land acquisition in Auroville, and LFAU was set up as a sub-unit of the Land Board in the late 2000s to communicate with donors and draw resources for land acquisition. Historically, the majority of funds for land purchase have come from donations from domestic and foreign donors, mostly through Auroville International Centres.³³⁹ Government grants, whilst significant in other sectors, have not been extended for land purchase. The records indicate difficulties in fund raising and low capital available to make purchases at inflated market prices. Given limited surplus generation in the commercial sector, Auroville is dependent on donations. These amounts do not seem to be sufficient: given market rates, a guesstimate of Rs. 800-900 crores are required to purchase the remaining land (excluding village settlements, where purchase / acquisition is not preferred). The Land Board, as of 2021, had a limited corpus of Rs.14 crores.

³³⁹ An early approach was made to the Central Government at the time of the 1999 draft Masterplan for an amount of Rs. 5 crores, yet the records do not indicate progress on that front.

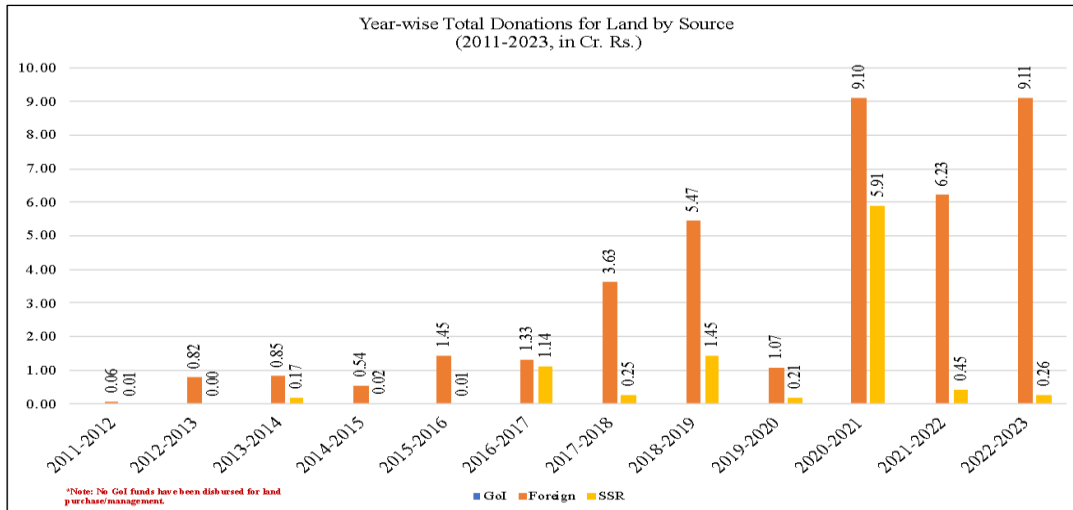

(Amount donated to the Land Fund. *Source:* Auroville Foundation Annual Reports)

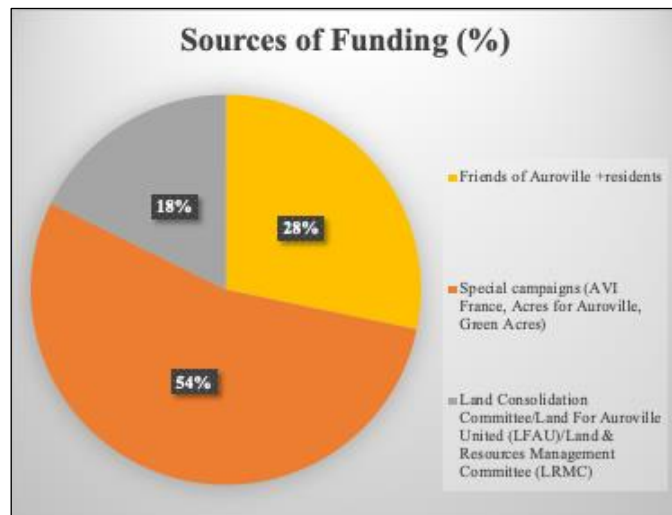

(Percentage contribution of varied sources to the Land Fund. *Source:* Auroville Foundation Annual Reports)

As of the most recent records made available to us, a total of 218 acres of land, in the ‘city’ area and the Green Belt have been reported as been acquired between 2006-2019.³⁴⁰ Data on total land acquired is not available for the years 2000-2006 and 2019-2023. Of the total area of 5212 acres, approximately 2949 acres (90% in the Green Belt but with strategic areas in the ‘city’) are yet to be acquired. The rate of land acquisition between 2001-23 appears to be inconsistent and displays sharp falls and spikes – whilst availability of land / the consent of owners is naturally a reason, it may be worthwhile to correlate this trend with the variability in acquisition and funding practices to examine if lessons can be learnt: for example, between 2014-16, there was an upward spike in the rate of land acquisition and these years also saw targeted campaigns by AVI France, which raised Rs. 2.6 crores. Similar campaigns for

³⁴⁰ This is reflected in the Auroville Foundations Annual Reports, 2006-2007 to 2019-2020, but we were not able to locate precise figures. This figure is subject to verification.

identified priority areas, with associated projects attached, rather than general appeals, may then prove to be a useful funding strategy.

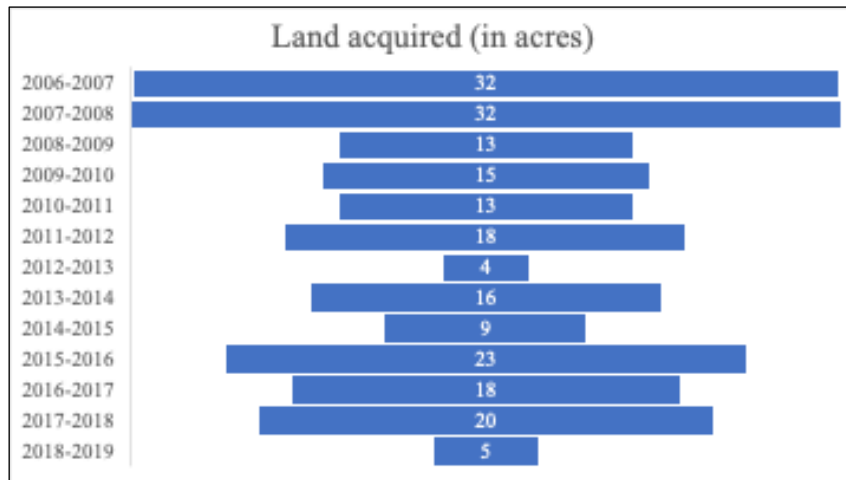

(Land acquired, 2006-19. *Source:* Auroville Foundation Annual Reports)

ii. Challenges and Development Priorities

Securing the remaining lands has been a priority across the board in planning documents since 2001, with concerns lying largely with insufficient funds (tied partly to low population numbers and insufficient scale), low densities / underutilization of existing land that make the NTDA option unviable, rising costs due to speculative development, encroachments and a preference against sale of lands owned by Auroville outside the plan area. We identify challenges and development priorities accordingly.

a. Organization

Given the organizational frame described above, the following points emerge:

- i. The strategic or operational reasons for regular modifications to the institutional structure, with eight changes between 2005-2020, are unclear. In interviews, we were unable to ascertain these reasons; in many cases, members involved in the sector were unaware of the institutional architecture. The mandate of these groups seems to largely overlap, leading to inefficiencies and operational uncertainty. The functions include land acquisition, managing and consolidating land holdings, protection and recovery of existing land from encroachments/incongruous developments, maintenance of and revenue generation from land, resolution of land disputes, record keeping and verification of land records and transfer of land title deeds / *pattas* in the name of the Foundation. As such, it is necessary to streamline all land-related processes and bodies, insofar as they are operational today, under the Land Board with clarity on accountability mechanisms in relation committees constituted under Sections 16 and 19 of the Auroville Foundation Act, 1988.

- ii. The Land Consolidation Committee was established by the Governing Board in 2008 under Section 16(1) of the AVF Act, 1988, with a seven-member Executive Committee comprising the Secretary to the Foundation, nominees of the TDC, FAMC and Working Committee, who ‘shall function under the overall direction of Chairman/Governing Board’. As we discuss in Part IV, the AVF Act, 1988 is clear insofar as land matters fall within the purview of the Governing Board, yet committees constituted under Section 16, as opposed to Section 19, require the presence of a member of the Governing Board, with non-voting participation for other members. The legal basis for this committee is therefore unclear and requires clarification.
- iii. The reporting structures of various bodies, whether to the Governing Board, Residents’ Assembly or Working Groups, are variously defined: while the LCC functions under the direction of the Governing Board, the mandates for LEM, LRMC, LFAU are not similarly defined. The accountability mechanisms of the Land Board too are unclear.
- iv. There appear to be human resource and competence constraints in the Land Board. Calibrating selection criterion to the competences required for the Board may be considered, across legal affairs (litigation, liaison with the Anti Land Grab Special Cell and District Magistrate for Villupuram), local affairs (knowledge of Tamil / village relations) and property / land systems management. Further, as land matters require a detailed knowledge of local regulations, customs etc., in which internal capacity in the community is weak, the Land Board may consider hiring professional consultants to conduct this work.³⁴¹ In general, as we discuss in Part IV.C, technical competence and integrity, measured by an expert-led body, not popularity, should be the criterion for appointment of Working Groups and professional consultants.
- v. There appears to be concerns with institutional continuity, given weak data management and a regular shuffling of team members with no structured handover process. This has resulted in a loss of continuity of work undertaken by one agency to another, particularly in relation to ongoing negotiations for purchase and exchange which depend on personal dynamics.

³⁴¹ Our assessment is in line with Vincent’s. Auroville Today, August, 2019, 19 (‘So what do you think should happen now regarding land purchase and management? The recommendation I made to the Governing Board is that land purchase should be taken out of the hands of Aurovilians and handled by professional people appointed by the Government. These people would be guided by the principles of the Master Plan and by advisers within the community. The job of the Auroville Land Board would only be to maintain what we have now, to ensure that what we have purchased is protected. The people appointed for this Land Board should be tested for their capacity to do the job: it should not be based upon ‘feelings’, upon whether or not we like them as people. These have to be people who really know the land and who understand the rules and regulations about land.’)

- vi. Accordingly, an integrated Land Management and Information System may be explored to digitize land revenue records with GIS integration, identify land use with a stewardship-database (records indicate that many lands owned by Auroville in the city-area are marked for agricultural use, which may require action), integrate a case management system for lands in litigation, identify encroachments in real-time and track ongoing negotiations for institutional continuity; digitize records for transparency in land exchange, with clear price discovery mechanisms.

b. Acquisition

- i. Undertake a land market survey of the plan area and bio-region with projected real estate prices over the next one / two decades to identify total resource need, with a fund mobilization plan.
- ii. Pursue a long-term interest-free loan option from the Central Government to purchase the remaining lands in the city area.
- iii. Strengthen AVI channels with targeted fund-raising campaigns tied to the 'Friend of Auroville' status.
- iv. Identify acquisition strategies for priority lands – as per the records, these are: all lands in the Residential Zone, three parcels pending for CIHRU, in the Industrial Zone, the areas between the Outer Ring Road, Mangalam Radial, Verite Radial and the Crown, between the Outer Ring Road, Verite Radial, CSR Radial and the Crown, lands on the Surrender Radial, Vikas Radial, Solar Kitchen Radial, Mangalam Radial, Verite Radial, CSR Radial and connecting road between the Verite and CSR Radial, the Ring Road from Mango Garden till Discipline and from Prarthana till Samridhi/Anusuya, Access Road from Verite crossing to the tar-road and lands in the Green Belt along the outer ring road; lands from New Creation to Samridhi, Arya to Swamy College, priority agriculture lands identified in the Green Belt Development and Land Use Plans.
- v. Clarify the contours and operational necessity of the 'buffer zone', to allow for sale / exchange of non-priority outlying lands, so identified, for priority 'city' and Green Belt lands identified above.³⁴²

³⁴² This is a critical task, highlighted in Kalra, 2014. The threat of speculation and rising land prices within the city area and the Green Belt do not allow Auroville the luxury of postponing measures. This matter was addressed by the Dr. Singh, Chairman of the Governing Board in 2014. His comments are as valid today, and require urgent action: 'Governing Board chairman Dr. Karan Singh, in an open letter to all Aurovilians dated December 5, 2013, expressed the Board's dissatisfaction with the progress of the land purchase for Auroville and mentioned that the city envisaged by The Mother is under serious threat from speculative developers buying large tracts of land in the neighbourhood. Stating that land prices have risen exponentially, making it difficult for Auroville to raise the resources required for the purchase of all the remaining lands in the city and greenbelt, and that funds from the Government of India for the purchase of land cannot be expected, Auroville has no option but to raise resources through sale or lease of lands outside the Master Plan area, or to exchange these lands for

- vi. Finalize the NTDA arrangement – for the Masterplan area or the ‘extended’ option, in that order of preference – if majority alignment option is secured, as discussed in Part III.C.
- vii. Explore land banking and pooling options, transferrable development rights, ‘peppercorn’ leasing, with right of first refusal and local / customary usufruct options.
- viii. Explore the public acquisition route targeted only to lands held speculative buyers / developers.
- ix. Examine protections under the Forest Act, 1927 and Environment Protection Act, 1987 for non-harmonious use in the Green Belt.
- x. Explore, in the interim to the NTDA, options to amend land use of Green Belt to agriculture / forestry to limit speculation.
- xi. Pursue ‘soft’ acquisition with collaborative agriculture – Godwill Zones, or Collaboration Hubs proposed earlier – and revive, strengthen action on 2014 MOUs with panchayats for a Village Development Plan for trust-building and to develop harmonious commercial / industrial profile, with public-private models, as discussed in Part III.C.

*

more critical lands in the city and greenbelt Stating that ‘it is incomprehensible to me and my colleagues in the Board as why the possessive attitude of a few Aurovilians refusing to move from their present location should block all progress in land consolidation,’ he informed the community that the Board has authorised the Secretary of the Auroville Foundation to have exploratory talks with the Swamy of Mailam temple who owns and controls a large plots of land in the Greenbelt.’ Auroville Today, 2014, No. 295, 7.

C. REGIONAL AND OUTREACH PLANNING

Integrating Auroville's development with the surrounding region has been a priority from the early days, inspired by Mother's push for a collaborative working relationship with residents of the local villages, the 'first citizens of Auroville.'³⁴³ This has manifested in three directions: regional planning, bio-region / outreach planning and co-operative planning with villages in the plan area through the 2011 Green Belt Development Plan Growth Management Framework. We provide a short review of regional and outreach planning activities in this section, and of Green Belt planning strategies in Part III. F.

i. *Regional Planning in the 1999 Masterplan*

In 1999, the Residents' Assembly Masterplan proposed an Extended Area Partnership Plan ('EAPP') and a Bioregional Partnership Plan ('BPP').³⁴⁴ The EAPP proposed the socio-economic development of 40 sq. km. of villages 'identified as critical ground water re-charge areas', reflecting the priority of environmental concerns of the time. The BPP was proposed for the economic and environmental development (watershed management) of the bio-region that covers 800 sq. km. around the Auroville Township. The document registered a concern for development in the bio-region, with the clear understanding that the villages in the plan area are to develop collaboratively, without displacement. Recognizing that this task was 'much more complicated than it sounds', the concern voiced was on two grounds: the social, economic and educational upliftment of the villages, and harmonious development in terms of physical infrastructure, roads, buildings, and the natural environment, agriculture, watershed management etc. The masterplan was envisioned to be a 'historic turning point in Auroville's development consciousness' as it is 'neither healthy nor possible for Auroville to develop in isolation.'³⁴⁵

On the suggestion of the Governing Board, the EAPP and BPP proposals were not incorporated into the 2001 Perspective Masterplan which limited itself to the plan area.³⁴⁶ Yet, as we discuss below, this extended emphasis on regional or integrated planning is important – particularly as the bio-region develops because of Auroville's own growth, Auroville risks a samsonite act that threatens its own ecological security. This is reflected in the amended 2014 Urban and Regional Development Plans Formulation and Implementation ('URDPFI') Guidelines, as also the earlier Tamil Nadu Town and Country Planning Act ('TCP Act'), 1971, which envisage the creation of regional development plans alongside city or township-level masterplans to avoid

³⁴³ Guigan, 2018, Vol. 2, 176.

³⁴⁴ Residents' Assembly Masterplan, 1999, 60-2.

³⁴⁵ Auroville News, 'Residents' Assembly Meeting on July 28th, 1999', 1999. Residents' Assembly Masterplan, 1999, 61.

³⁴⁶ 20th Meeting of the Governing Board, 1999, 6 ('The Governing Board felt that no purpose be served unless the Master Plan is notified by the Central Government. A Master Plan is for land use in a territorial entity but not based on ownership of the land. Therefore, the Master Plan can only be for 'Auroville area' as can be established under the Act. Also, the harmony with the villages maintained over thirty years of Auroville's existence should not be disturbed. The local people including local land owners should not be put to any undue difficulty. Keeping all these in mind, the Government notification has to be sought only for the 20 sq. km. area covered by the Auroville Universal Township Master Plan.') June, 2018 and 19 September, 2019 again to pursue the NTDA option, but this time, 'over a *broader* area than the Auroville Master Plan.'

isolated urban clusters and a conscious rural-urban transition.³⁴⁷ A regional integration plan is also necessary to eschew Auroville's exceptionalist, elite image. As Revi notes:

Bioregional development holds the promise of building many bridges between what Auroville represents and the material reality of contemporary India. Enabling this would help address the limited perception that Auroville is more than just a well resourced enclave in which a small number of people have the luxury of engaging with a range of important material and spiritual adventures, relatively disconnected from the rest of India. The development of a bioregional plan for one of India's most backward districts appears not only a fundable idea, but a serious contribution towards charting a path from a very challenging set of local social, economic and environmental conditions to a reduction of poverty, improving quality of life and greater sustainability. This could build a critical official vehicle to accelerate the diffusion of important innovations from Auroville that could help transform the living and working conditions of the villages in the bioregion.³⁴⁸

A notable bio-regional architecture has been created over the years through individual projects, particularly in education, health and local employment, yet, as we discuss in section (ii), systemic challenges remain as the proposed plans have not yet been drafted by the community to secure an orderly development of the bio-region. Equally, regional planning beyond the immediate bio-region has been markedly absent. We pay attention to two issues of particular concern: first, non-harmonious development in the plan area on lands not owned by Auroville, and second, proactive regional planning to ensure an integrated development with villages and urban centers in close proximity.

ii. Proposal for a New Town Development Authority

As we discussed in Part III.B, approximately 10% of the land in the city and 85% of the land in the Green Belt is not owned by Auroville. Till such time as those lands are purchased, a major concern reflected in the records is to prevent non-harmonious developments in the plan area. This has been reiterated *itendidum* across fora since the 1999 draft Masterplan, particularly in relation to the constitution of an NTDA. We first outline the contours of extended negotiations on this point between 2002-2023, and then weigh available options based on a reading of the Town and Country Planning Act, 1971.

a. Policy Proposals, 2002-2023

Discussions on an appropriate scheme for legal protection of lands, including an NTDA, started in 2002, with an offer by the State Government in 2003 by way of a Government Order. The issue was raised again between 2010 to 2016, after the notification of the Masterplan by the Land Protection Status Study Group, NTDA Task Force, TDC and Working Committee. Discussions reached an advanced stage at this point, with a proposal from the State Government on the lines requested by the TDC. The matter was paused for community discussions between 2016-18, with three General Meetings of the Residents' Assembly and a series of workshops. These were inconclusive. The matter was taken up again in 2019, including by the Land

³⁴⁷ See, Town and Country Planning Organization, 2015.

³⁴⁸ Revi, 2007, 2.

Protection Team, but without a final resolution. We review these policy developments presently.

1. Promulgation of the Masterplan and the No Objection Certification

The matter was first addressed by Mr. Singhvi, member of the Governing Board, who had written to the Chief Minister of Tamil Nadu on 16th February 2002 to ‘promulgate’ the Masterplan for ‘protection of the area from potential speculators who want to take undue advantage of the ecological development made by Auroville.’³⁴⁹ Mr. Singhvi proposed that the State Government issue an order in favour of the Auroville Foundation similar to the one issued for the Tamil Nadu Housing Board such that ‘no one may develop, buy, or sell any area, which falls within the Masterplan of Auroville, unless the Auroville Foundation gives a no-objection Certificate’.³⁵⁰ The Chief Minister replied on 1st March, 2002 promising to give the proposal ‘serious consideration’, but to the best of our understanding, no further action was recorded on Mr. Singhvi’s proposal.³⁵¹ Subsequently, a letter dated 1st July, 2002 from the Special Commissioner of Town and Country Planning, Tamil Nadu to the Housing and Urban Development Ministry of Tamil Nadu considers the request of the Auroville Foundation to notify the plan area as a ‘Regional Planning Area ... in view of severe ecological stress faced by the region due to rapid and unplanned urbanization’.³⁵² The TCPO took a favourable view of the request to declare Auroville as a Regional Planning Area and suggested policy action under the TCP Act, 1971, whereby land use plans would be regulated by a regional planning authority.³⁵³ Interestingly, the proposal at this time indicates that a member of the Governing Board be nominated as a member of the Regional Planning Authority, yet in view of the ‘autonomy [granted] to the Residents’ Assembly’ under the Auroville Foundation Act, 1988, it recommended that the regulations in the regional planning area would be enforced by the Residents’ Assembly.³⁵⁴

2. ‘Composite Planning Authority’: Government Order, 2003

In its reply dated 26th July, 2002, the Housing and Urban Development Department (‘the Department’) wrote to the Secretary of the Auroville Foundation indicating that the Government of Tamil Nadu had ‘suggested for [the] constitution of a composite planning authority as in Major district towns instead of [a] Regional Planning authority’.³⁵⁵ The Foundation’s remarks on this amended proposal were accordingly requested. It bears

³⁴⁹ Singhvi, 2002, 1.

³⁵⁰ Singhvi, 2002, 2.

³⁵¹ Jayalalithaa, 2002.

³⁵² Special Commissioner of Town and Country Planning, 1st July, 2002, 1. Due to concerns over the legality of approving the 2001 Masterplan by the Human Resource Development Ministry (since resolved, with the notification of the plan in 2010), it was also suggested that the plan area be protected by a ‘separate legislation’ as a heritage site / town. This proposal does not figure prominently in discussions since.

³⁵³ Special Commissioner of Town and Country Planning, 1st July, 2002, 2 (‘The request is now to declare the area as regional planning area under Tamil Nadu Town and Country Planning Act. Though the Auroville (major portion) comes part of the Town and Country Planning Department administrative region of Chengalpattu and lies within the district of Villupuram, declaration of regional planning area and a Regional Planning Authority even at the concerned district level require a major policy decision and planning at local level would be ideal to protect the interests of Auroville than at regional level.’)

³⁵⁴ Special Commissioner of Town and Country Planning, 1st July, 2002, 2.

³⁵⁵ Deputy Secretary, Housing and Urban Development Department, 26th July, 2002.

mentioning that a composite authority is an amalgam of local planning authorities, an easier option than a regional authority that would encompass a larger area under Auroville and inevitably attract greater political risks. The Secretary-in-Charge at the time responded on 30th August 2002 to note that the Governing Board was in agreement with this proposal, provided that the protections recorded under the earlier arrangement are maintained, namely: (i) the composite authority will have authority under the 1971 TCP Act to regulate land use in the plan area; (ii) the Masterplan will be incorporated in the planning area with necessary regulations enforced by the Residents' Assembly; (iii) the authority will include a member of the Governing Board; and (iv) the remaining area, outside the Masterplan, will have separate land use plans regulated by the composite authority.³⁵⁶ These requests, as we will see below, have remained about the same till 2022, repeated by various study groups and community processes. Subsequently, on 20th January, 2003, a Government Order of the Department noted:

The Government after careful consideration, and after taking into account of the fact that the Auroville Foundation has been formed under a Central Act, accept the request of the Auroville Foundation. The Special Commissioner of Town and Country Planning is accordingly requested *not to* approve any layouts in respect of those lands which are sought to be acquired for Auroville Foundation when once land plan schedules are sent by the Auroville Foundation to the Revenue Divisional Officer for initiating land acquisition proceedings.³⁵⁷

To the best of our understanding, this offer of the State Government was not acted upon. Anecdotally, we were informed that the concern was two-fold: first, that the residents did not wish to engage in land acquisition proceedings and second, they wished to avoid the political representation on the 'composite authority'. However, an opportunity was missed at this point: if the Government Order was acted upon, non-harmonious land use in the Masterplan area could have been avoided in 2003, ending speculation. While the order itself does not grant approval or enforcement powers to Auroville, the powers of the TCPO to approve layout plans in relation the plan area would have been circumscribed. The acquisition proceedings, even if notified, need not have been conducted immediately, or indeed, completed, but kept pressures at bay as in interim protection pending final resolution. Similarly, the representation on the composite authority is a matter that could have been resolved through an appropriate representation formula. Whilst not a permanent solution, it offered valuable interim protection. No further communication resulted following the 2003 Government Order.

3. Four Options for Harmonious Development, 2011

Subsequently, after the notification of the Masterplan in 2010 and the constitution of the Town Development Council in 2011, the matter was revived in a letter from the Secretary to the Foundation to the Collector of Villupuram District dated 13th June, 2011. The Secretary requested the Collector to issue necessary instructions to the Village Panchayats to 'co-operate' with the Town Development Council, i.e., that they do not 'grant any permission for development activities within the area notified by the Government of India as Master Plan

³⁵⁶ Secretary-in-charge, Auroville Foundation, 30th August, 2002, 1-2.

³⁵⁷ Housing and Urban Development Department, G.O. (Ms.) No. 6, 2003, 2.

Area.³⁵⁸ The legal basis for this request, without a corresponding order by the State Government, is unclear. The notification of the Masterplan by the Human Resources Ministry arguably does not *ipso facto* have a binding effect on privately owned lands in the plan area, nor does it make the Foundation / Town Development Council the planning authority.

A range of options were considered at the time to activate legal protection by the Land Protection Status Study Group from August, 2013 to January, 2014. In its report dated 4th February, 2014, which is the most detailed assessment of the issue in the records, it evaluated nine ‘legal propositions’ and four ‘non-statutory legal options’.³⁵⁹ The main conclusions and recommendations of the Status Study Group were:

- (i) the Auroville Town Development Council must engage in a dialogue with the Town and Country Planning Department of the Tamil Nadu Government to discuss the constitution of a New Town Development Authority for the Auroville Master Plan area, (ii) the status of World Heritage for Auroville is to be pursued and (iii) the procurement of the remaining lands within the Master Plan area, Green Belt included, is to be pursued.³⁶⁰

These were presented to two General Meetings of the Residents’ Assembly on 29th January, 2014 and 13th February, 2013, after which the Study Group ‘retired’.³⁶¹ To the best of our understanding, the Residents’ Assembly did not pass a decision.

Four options of relevance were discussed at this time.³⁶² First, to rely upon the 2003 Government Order. Second, to request the State Government to approve a land use plan for Auroville and the region without a regional, composite or local planning authority. Third, to request the constitution either of a New Town Development Authority and a Regional Planning Authority under Sections 11(2) and 11(4) of the 1971 TCP Act. Fourth, to request the constitution of a Local Planning Authority under Section 11(1) of the 1971 TCP Act. The weight of the opinion at the time seemed to be in favour of the fourth option, as it would provide for an enforceable option that could secure majority representation from Auroville. The first option, relating only to land proposed to be acquired offered an interim solution since it did not include a planning authority, was thought unviable. The second option similarly would provide powers to the local administration to approve land use plans based on their interpretation of the Masterplan, which again placed final planning authority outside the Foundation and carried the political risk of the district administration having a final say in the interpretation of the Masterplan. The third and fourth options were considered viable, with a preference for the fourth as greater representation could be ensured. As these options were being evaluated, it appears that a letter was issued by the Assistant Director (Village Panchayats) dated 20th June, 2011 to the Block Development Office, Vanur Union, notifying that permission for development in lands other than *natham* areas would require an NOC from the Auroville

³⁵⁸ Secretary, Auroville Foundation, 13th June, 2011, 2.

³⁵⁹ Land Protection Status Study Group, 4th February, 2014, 2-4.

³⁶⁰ Land Protection Status Study Group, 4th February, 2014, 1.

³⁶¹ Bertrand / NTDA Task Force, ‘Report to the Secretary’, n.d., 15.

³⁶² See, Van Megan, 20th October, 2011; Van Megan, 25th September, 2012 for a helpful discussion of these options, proposed by the Land Protection Status Study Group.

Foundation.³⁶³ This was a significant step; however, we were unable to locate this document and it appears that this protection has not been actively used since. We were unable to identify the reasons behind this policy.

4. Finalization of the 'limited' NTDA Proposal, 2012-2016

Subsequently, on 18th February, 2012, Mr. Doshi, Chairman of the Town Development Council, wrote to the Department to request a new Government Order which would make 'development approval from the Auroville Foundation ... mandatory for all proposed developments within the Auroville Masterplan area', thus reviving the earlier request of 2002, that met with limited success as the 2003 Government Order only provided limited protection for lands sought to be acquired.³⁶⁴ Alongside, Mr. Doshi wrote to the Department to indicate Auroville's intention to work with the Department to prepare land use and masterplans for non-plan areas in the region to allow for integrated development, a notable example of a proactive and regionally focussed approach that can waned since the 1990s.³⁶⁵ A meeting was subsequently held with the Commissioner of Town and Country Planning in Chennai on 25th September, 2012.³⁶⁶ Six months later, in February 2013, a formal proposal for the New Town Development Authority – option 3 above – was made, with a further round of discussions with the Department. Alongside, a new NTDA Task Force was constituted by the TDC in March, 2014 whose aim was to 'follow the administrative and legal process for the constitution of an NTDA', based on the recommendation of the Status Study Group.³⁶⁷ The Task Force's mandate was endorsed by the Governing Board in August, 2014. Alongside, the body conducted extensive community engagement: it 'maintained an ongoing community participation taking the form of information sharing, meetings, and debates', gave presentations to the FAMC, Green Group, Working Committee, Auroville Council, held a 'General Information Meeting' in March, 2015 'to answer questions and clarify the NTDA process', published a FAQ document on 13th April, 2015, and setup a daily information desk from April 20th-205th, 2015 at the Town Hall 'to answer any query from the community.'³⁶⁸ This led to a third General Meeting of the Residents' Assembly on the issue on 7th July, 2015, in which 'more than 100' residents participated, with a 'full report of the meeting' circulated by the Residents' Assembly Service to the community inviting comments.³⁶⁹ No final decision was taken.

Alongside, on 27th August, 2014, the Undersecretary to the Foundation wrote to the State Government requesting the constitution of an NTDA.³⁷⁰ On 18th June, 2015, the Working Committee also wrote to Dr. Swaminathan, ex-Chairman of the Governing Board, who had offered his good offices to assist in the matter.³⁷¹ Importantly, in a letter of 5th August, 2015, Mr. Doshi also wrote to Dr. Singh, Chairman of the Governing Board in support of the NTDA – he emphasized the need for a legally constituted planning authority to prevent unregulated

³⁶³ This letter is mentioned in the correspondence, but we could not locate a copy.

³⁶⁴ TDC, 'Auroville Master Plan implementation', 18th February, 2012.

³⁶⁵ TDC, 'Master Plan for surrounding areas', 18th February, 2012.

³⁶⁶ Commissioner of Town and Country Planning, 15th September, 2012.

³⁶⁷ Bertrand / NTDA Task Force, 'Report to the Secretary', n.d., 16.

³⁶⁸ Bertrand / NTDA Task Force, 'Report to the Secretary', n.d., 16.

³⁶⁹ Bertrand / NTDA Task Force, 'Report to the Secretary', n.d., 16-7.

³⁷⁰ Under Secretary, Auroville Foundation, 27th August, 2014.

³⁷¹ Working Committee, 18th June, 2015, 1.

development, mindful of associated political risks, and for Auroville to fast-track its own attempts at producing a DDP, which would be a legal requirement under Section 12(1)(c) once the NTDA was in place:

Legal recognition by the local government is necessary to prevent unregulated development on private lands within and outside peripheral area of the Master Plan. We need to have formal approval by an appropriate planning authority established as per the Town and Country Planning Act of Tamil Nadu. To obtain the necessary approvals, in February 2012, after the constitution of the TDC, we wrote to the Secretary of Housing and Urban Development of Tamil Nadu Government requesting him to take steps including forming a separate authority to protect the land use within and outside the area of the Auroville Master Plan.

In September 2012, we received a proposal by the local authorities to constitute a New Town Development Authority (NTDA). Three members of the NTDA (the collector, the local MLA and the head of the local planning dept) are nominated ex-officio and the remaining members are nominated by the State govt. We have proposed that some of them may be appointed after a recommendation by the Auroville Foundation in order to better safeguard the interests of Auroville in this local govt entity.

Under the existing law there are three types of appropriate planning authorities that can be constituted in the area of Auroville. After studying the matter for all these years, the TDC came to the conclusion that the most suitable option is the establishment of a NTDA because this type of planning authority can be constituted for special purposes and therefore we can ask to recognize the special character of Auroville.

...

However, for your information, the process of constituting an NTDA is not exempted of any political risk, because it has to go through a public consultation. This aspect has been studied, but since our Master Plan also aims to regulate the development on land that is presently under private ownership, even any other solution adopted should go through public consultation.

Therefore, this is a step we may be obliged to take. Procedurally, the NTDA will have to prepare a DDP within one year of its constitution. To make sure that Auroville will get the necessary protection, it is important for the TDC to prepare a DDP before the above deadline, which we will fulfil.³⁷²

The TDC accordingly made a detailed presented to the District Collector of Villupuram at this time.³⁷³ These developments came to a head when the District Collector wrote in support of the proposal to the Director of the TCPO on 25th October, 2015, along with a supporting ‘justification report’ of the Assistant Director, TCPO, stating that there is an ‘indispensable need to have a new Town Development Authority’, to allow for the effective implementation

³⁷² Doshi, 5th August, 2015, 1-2.

³⁷³ TDC, Auroville Masterplan Protection, 2015.

of the Masterplan.³⁷⁴ This included the five revenue villages of Kottappupam, Bommaiypalayam, Rayadhupakkam, Mathur and Irumbai, and some neighbouring villages, covering 230.4 sq. km, i.e. significantly beyond the Masterplan area. The letter notes the pressing need for legal enforcement possible only through a planning authority:

In the above Master Plan, a separate Land Plan Schedule was not prepared and not given approval to it; therefore, there are difficulties to implement the Master Plan. It is difficult to implement by local bodies also as the Auroville Master Plan area has some parts of a town panchayat and the village panchayats.

...

As the villages around Auroville Township are surrounded by the Union Territory of Pudhucherry, the development work of urbanisation is taking place rapidly. Industrialisation also is increased in this area. There are no technical staffs who can monitor them. Commercial buildings, industrial buildings and public buildings were given approval with the damage of rules by the local panchayat presidents. Therefore, it is an indispensable need to have a new Town Development Authority, to regulate these and to prepare a complete Master Plan, functioning under the Department of Town and Country Planning.

After the extension and the further development of East Coast Road, the transport facilities are increased and the tourist related developments are increased at a big level. In contradiction to Auroville Master Plan, housing layouts, retirement rest houses and hotels are built and they are in use. Therefore, to protect the environmental works in Auroville, to implement the proposals of Auroville Master Plan, it is essential to have a Planning Authority legally.

Therefore, to implement the Auroville Master Plan approved by Central government, to regulate the nearby development, to regulate the developments by getting proper approval, under the section 10(1) of Town and Village Planning Act 1971, a new Auroville Town Development Authority may be formed.³⁷⁵

On the back of this supporting letter, the NTDA Task Force, as the representatives of the TDC, met the Secretary of the Department on 17th February, 2016 and at his request, the Town Development Council wrote to the Department on 23rd February, 2016 suggesting again an NTDA for Auroville, yet *only* for the Masterplan area, such that Auroville's vision is not 'lost in the midst of a larger NTDA area.'³⁷⁶ The proposal noted:

The Directorate's proposal recommends the inclusion of 1 town Panchayat and 19 revenue villages over an area of approx. 230 sq. km. in the proposed NTDA. If this view is to be pursued then a special provision, in the NTDA notification and the establishment may need to be included for the Auroville Master Plan area which encompasses only 20 square kilometers of the total proposed area ... Preserving the unique character of Auroville may be achieved by inscribing the goals and purpose of Auroville, as defined in its charter and in the Auroville Foundation Act, in the Government notification establishing the N.T.D.A. This may further be accomplished by allowing Auroville's representation in the N.T.D.A and by sanctioning a delegation of power to the Auroville Foundation for the Auroville Master Plan area, as provided

³⁷⁴ District Collector, Villupuram, 25th October, 2015, 1.

³⁷⁵ District Collector, Villupuram, 25th October, 2015, 1-3.

³⁷⁶ TDC, 23rd February, 2016, 1.

for in the Town and Country Planning Act 1971; to that effect the notified Auroville Master Plan foresee the establishment by the Auroville Foundation of "Prescribed Authority" for its implementation, ... During our meeting, the option of creating an N.T.D.A exclusively for the Auroville Master Plan area was also discussed...If the N.T.D.A was to be exclusively created for the Auroville area, Auroville would request that the Tamil Nadu Government formally ensures that the nominated members to the N.T.D.A are jointly proposed by the Tamil Nadu Govt. and the Auroville Foundation ... We suggest that the notification explicitly mentions that the land use plan to be approved by the N.T.D.A. will correspond to the notified Auroville Master Plan which include zoning regulations and broad definitions of land use.³⁷⁷

This marks an important shift in the policy stance, with a request for an NTDA only for the Masterplan area and not beyond. This is a key consideration that was accepted by the Secretary of the Department, as per the report of the NTDA Task and reiterated later to the Land Protection Team in 2019-20. This is underappreciated in the records since: as we note below, the Secretary to the Foundation adopted a different stance in his letters of June, 2018 and 19 September, 2019, when he requested an NTDA option over a 'over a *broader* area than the Auroville Master Plan.'³⁷⁸ The TDC reiterated that the smaller NTDA 'would address the unique requirements of Auroville' including a formal guarantee that members jointly proposed:

If the NTDA was to be exclusively created for the Auroville area, Auroville would request that the Tamil Nadu Government formally ensures that nominated members to the N.T.D.A. are jointly proposed by the Tamil Nadu Govt. and the Auroville Foundation. One of the appointed members, endorsed by the Auroville Foundation, could either be the Chairman of the Secretary of the constituted Authority.³⁷⁹

This was a 'simpler and more easily implementable solution over the current proposal of an extended NTDA.'³⁸⁰ On 19th March, 2016, the TDC wrote to the Department to further this option, requesting that (i) the Masterplan be recognized as part of the NTDA notification, (ii) the TDC be recognized as the planning body, that may issue no objection certificates for any proposals being considered by the NTDA, and (iii) members of the NTDA be 'jointly nominated' by the State Government and the Auroville Foundation.³⁸¹

The matter seems to have been close to resolution at this point. The Department was amenable to this proposal and wrote to the TDC on 15th July, 2016 proposing a 'Special New Town Development Authority', the 'objective of which will be to preserve and promote the ethos of the Auroville International Township.'³⁸² The Department was further aggregable to delegation of powers under Section 91 of the 1971 Act, as requested by the TDC.³⁸³ The correspondence

³⁷⁷ TDC, 23rd February, 2016, 1; Bertrand / NTDA Task Force, n.d., 13.

³⁷⁸ Secretary, Auroville Foundation, 25th June, 2018; Secretary, Auroville Foundation, 19th September, 2018 1-2 (emphasis ours). The Secretary requested a delegation of powers under Section 122 of the 1971 Act – this is not tenable as Section 91 excludes 'power of the Government to make rules' from delegation.

³⁷⁹ TDC, 23rd February, 2016, 2.

³⁸⁰ TDC, 19th March, 2016, 1.

³⁸¹ TDC, 19th March, 2016, 1-3.

³⁸² Secretary, Housing and Urban Development Department, 15th July, 2016.

³⁸³ Secretary, Housing and Urban Development Department, 15th July, 2016, As we discuss below, it is unclear what this 'delegation' comprises. The power of the NTDA to approve and regulate land use is provided by statute, such that no further delegation under Section 91 is necessary. It appears that this delegation relates to the powers of the proposed NTDA itself to the Foundation for the plan area under Section 91-A, which would allow

does not refer to a formal guarantee of joint appointment, yet we are informed by members of Working Groups that the Department agreed to the suggestion. The Department's openness and support for Auroville at this point bears noting:

In his request to prepare a NTDA proposal, solely for the Auroville area the Secretary has followed to the letter, the request of Auroville. In that regard Auroville can hardly expect a greater conciliatory collaboration from the State.³⁸⁴

To the best of our understanding, this proposal met all of Auroville's requirements, subject to the manageable and inevitable political risks we discuss below. The Department wanted to finalize the matter 'immediately', by 20th July, 2016.³⁸⁵ However, the records indicate that it was not acted upon and is pending till date. Despite the Department having accepted the proposal made by the TDC 'to the letter', the matter seems to have been paused at this advanced stage to allow for community discussions.

5. Inconclusive Discussions, 2016-2019

More than a year later, in December 2016-January 2017, a well-attended community feedback and discussion process was initiated to apprise residents of the legal and governance options in relation to land protection.³⁸⁶ Following this process, a 16 member 'Core Group', formed between the TDC, Working Committee and Auroville Council, recommended that the NTDA Task Force 'be merged into a new team for Land Protection', to present its findings to the Residents' Assembly in three months.³⁸⁷ Insofar as governance practices are concerned, we discuss in Part IV, five issues are unclear or of concern at this point. First, it is unclear as to why another group in addition to the Task Force, or the extended community process, was necessary at the penultimate stage of the negotiations with the Department when questions identified at the 10-11th December, 2016 and 7th January 2017 workshop had already been studied between 2003-2016, including by Dr. Doshi, Working Committee, TDC, Land Protection Status Study Group and the NTDA Task Force. Indeed, extensions community discussions outlined above and three General Meetings of the Residents' Assembly were previously conducted by the Land Protection Status Study Group and the NTDA Task Force.

Having conducted robust community engagement, solicited expert input and negotiated a solution with the Department, the executive authority of Working Groups – in this case, the TDC – to decide and implement appears to be undefined or weak. As we note in Part IV, whilst participation is key, it can neither be repetitive and directionless nor a substitute for executive authority to decide in a time-bound manner after due engagement. Second, it is unclear why an independent body, of sixteen members, outside the TDC was required, given the TDC's clear executive mandate under Standing Order 1/2011 at the time to implement the Masterplan and thus secure an NTDA. Third, it is unclear as to how this body was formed, as no defined

'any committee or officer' nominated by the NTDA (which we assume is one nominated by the Foundation jointly) to issue approvals and regulate land use in the plan area. This is a valuable option, as we discuss below, which provides strong reasons in favour of the NTDA. It bears emphasis though that this power is revocable by the NTDA, which may 'cancel such order.'

³⁸⁴ Bertrand / NTDA Task Force, n.d., 22.

³⁸⁵ Secretary, Housing and Urban Development Department, 15th July, 2016,

³⁸⁶ News and Notes, No. 683, 2017 ('This workshop was attended by about 120 people, and consisted of 3 full morning sessions as well as a series of 4 meetings attended by a Core Group of workshop participants to investigate the options further and prepare a set of recommendations to be presented on the 3rd Workshop day.')

³⁸⁷ News and Notes, No. 683, 2017. Bertrand / NTDA Task Force, 'Report to the Secretary', n.d., but likely in 2016, contains a good summary of developments till that point.

competence / qualifications / representation formula were identified – as we note in Part IV, the selection of executive bodies or sub-groups must be informed by an assessment of expertise and / or representation from the Zones to allow for effective conduct of work. Fourth, there is a concern with regulatory inflation, given the joint accountability of this new group to the Working Committee, Auroville Council and the TDC, without a clear definition of distribution of responsibilities and powers as between them. Fifth, there appears, as elsewhere, to be a conflation of the legislative, executive and community domains as between the Residents' Assembly, TDC / Working Groups and community fora, such as the Land Protection workshops. This leads to a circular process of placing operational matters concerning the implementation of the Masterplan, after the policy has been laid down by the Residents' Assembly and community engagement is conducted, back to those fora, which is unwise and inefficient as a matter of good governance.

Subsequently, in May, 2018, this new Land Protection Group submitted its recommendations for a fourth Residents' Assembly General Meeting on the issue, in which it supported the NTDA option and suggested in addition a request to amend the 1971 Act to 'delegate all legal planning power to the Auroville Foundation' and explore 'unique Statutory land use regulations framework suitable for the Auroville conditions.'³⁸⁸ The legal or strategic basis for this proposal for a 'delegation' of 'legal planning powers' through an amendment in addition to the NTDA is unclear – an NTDA would transfer powers to regulate land use and approve developments in accordance with a new town development plan to the NTDA, an entity legally independent of the Auroville Foundation but on which it may have representation, such that no further 'delegation' from the State Government is necessary. The offer made on 15th July, 2016 was for an NTDA, with a delegation of powers, albeit revocable and subject to control / revision, of the State Government / Town and Country Planning Organization under Section 91 to approve specified developments that lie within their scope as clarified from time to time by administrative orders. This delegation of powers to regulate land use under the legislation is different from the Land Protection Group's mention of delegation of 'legal planning powers.' Indeed, it is unclear what the latter would comprise. We discuss this below.

Their proposal for a statutory amendment relates to an earlier proposal made in 2010, not discussed down the line in the correspondence for reasons we discuss below, for an amendment to the 1971 Act for the creation of a 'Special Development Authority' / a 'special delegation of powers' to allow for an independent functioning of the Auroville Foundation *as* the planning authority – as opposed to an NTDA on which the Foundation would have representation – and, we may suppose, without the overriding powers of the State Government under Sections 22, 24 and 32. In any case, this statutory amendment option does not seem to have been taken forward, with the Secretary to the Foundation writing to the State Government in June, 2018 and 19 September, 2019 again to pursue the NTDA option, but this time, 'over a *broader* area than the Auroville Master Plan.'³⁸⁹ This seems to be the second significant policy reversal from the TDC's February, 2016 request for a 'smaller NTDA', which was viewed favourably by the State Government that did not wish to engage the 'extended' option. There appear here to be several parallel processes, with Auroville – as a whole, across its bodies – making different representations.

³⁸⁸ Van Megan, 2018, 1.

³⁸⁹ Secretary, Auroville Foundation, 25th June, 2018; Secretary, Auroville Foundation, 19th September, 2018 1-2 (emphasis ours);

A subsequent meeting was organized with the Secretary of the Department on 10th June, 2019, where the statutory amendment option was discussed. It was noted that: (i) the NTDA option provides sufficiently flexibility to address Auroville's concerns, particularly for the preparation of development plans for the region, such that a statutory amendment to the TCP Act, 1971 can be 'discarded', (ii) the Government is amenable to appointing the five non *ex officio* members on the NTDA in consultation with the Auroville Foundation, and (iii) that developing some legally enforceable form of land use protection is urgent for Auroville, given the rising threat of speculation. This was an important meeting, where matters discussed over the previous four years came to a head. 'Notes' from the meeting shared with us record as follows:

Auroville Foundation should be the most concerned that a statutory land use authority is established for the Auroville master plan area as soon as possible. With the present situation anything can be built anywhere. If someone wants to build a big five star hotel somewhere in the middle of Auroville, with today's situation that cannot be stopped. Hence Auroville should pursue statutory land use regulation more than anyone else.

A letter is needed from the Auroville Foundation giving a *clear signal* that Auroville wants to move forward. In that letter the concerns of Auroville can also be included. *On receipt of that letter, the formal process will start and will be completed in a phased manner.*

If Auroville does not pursue the NTDA option, Government may also not pursue it further. But at anytime in the future Government may establish a regional planning authority and Auroville would then fall within such regional planning area. Before that happens it is highly advisable for Auroville to work with the Government on an NTDA so that the specific needs of Auroville can be accommodated to the maximum extent possible.³⁹⁰

The Department's proposal to form an NTDA is also reflected in the report of NTDA Task Force in 2014-15 and the Land Protection Group in 2020:

Auroville's latest interaction with the concerned State Agencies has produced a formal proposal characterised as a 'concept for a new Auroville Town Development Area' by the Director of the DTCP. It was presented in October 2015 by the District of Villupuram Collector and proposed that Auroville be in the midst of a 230 km² NTDA, an area tenfold the Masterplan's own. Such an NTDA would bring Auroville and the neighbouring villages under the same planning Authority. Presented with that solution Mr. Yadav, the HUD Secretary, felt it would be difficult to guarantee an individualized Master Plan for Auroville when the NTDA was responsible for the production of a Master Plan for the entire area under its care. The Secretary requested a smaller NTDA covering the Master Plan area, attributing a broad delegation of power to the Auroville Foundation and its assignee in conjunction with rules of the TCP Act.

³⁹⁰ 'Notes from meeting with Secretary, Housing and Urban Development', 10th June, 2019 (emphasis ours). The document does not record an author, and as such, we could not verify its authenticity. Interviews support the views expressed. A letter from the Secretary, Auroville Foundation, 4th October, 2019 requested a further meeting, but does not mention the previous discussions had with the Working Committee.

Presented with that solution Mr. Yadav, the HUD Secretary, felt it would be difficult to guarantee an individualized Master Plan for Auroville when the NTDA was responsible for the production of a Master Plan for the entire area under its care. The Secretary requested a smaller NTDA covering the Master Plan area, attributing a broad delegation of power to the Auroville Foundation and its assignee in conjunction with rules of the TCP Act.³⁹¹

As a result of this interaction the Directorate of Town and Country Planning of Tamil Nadu Govt. has proposed the constitution of an NTDA ... covering a large part of the block of Vanur and including the area of the Auroville Master Plan and submitted this recommendation to the Secretary of Housing and Urban Development of Tamil Nadu Govt.³⁹²

However, the formal process to activate the NTDA option does not appear to have been initiated. On 5th October, 2019, the Secretary to the Foundation wrote again to the Department to ‘further explore the NTDA option’, though without reference to the earlier offer.³⁹³ Similarly, on 14th November, 2019, the Working Committee wrote to the Department proposing a Government Order ‘recognizing [that the] ... Auroville Foundation [has] the right to prepare and develop its master plan over the land it owns and making it an additional planning authority for the lands within the designated area.’³⁹⁴ How this proposal for an ‘additional planning authority’, a legally undefined term under the 1971 Act, relates to the earlier discussions is unclear.

6. *Shift in Policy Stance, 2020*

Later, in January, 2020, the Land Protection Team, formed to follow up on the recommendations of the community workshop in 2017, issued a report with a ‘new proposal’, marking the third policy shift.³⁹⁵ Instead of notifying the plan area through an NTDA, and then preparing plans and holding consultations, the Land Protection Team suggested that the process be reversed: Auroville would first prepare a land use map at the plot level for all lands in the Masterplan area, then develop a proposed land use plan in consultations with panchayats and village residents, and finally, the ‘agreed and approved document would then be endorsed by the State as the land use and development plan for the township area and the mode of enforcement will be assessed and studied at that time’, including a ‘mutually acceptable mode of review and /or consultation with the Auroville Foundation for the issue of NOC within the master plan area with the local authority.’³⁹⁶

This is a significant shift from the earlier stances taken since 2003. While an NTDA option – for only the plan area and later including the Vanur area – was suggested in 2016 / 2018-19, the new Secretary appointed to the Department suggested that land use issues be decided first in public consultation, and ‘at the end of this process [they may] decide the legal and

³⁹¹ Bertrand / NTDA Task Force, ‘Report to the Secretary’, n.d., 19.

³⁹² Report of the Land Protection Team, 2020, 1-2.

³⁹³ Secretary, Auroville Foundation, 5th October, 2019.

³⁹⁴ Working Committee, 14th November, 2019.

³⁹⁵ Report of the Land Protection Team, 2020, 8.

³⁹⁶ Report of the Land Protection Team, 2020, 5.

institutional framework.³⁹⁷ While there is merit in the focus on a consultative approach to development of the plan area, surprisingly, the land use regulation and enforcement question, the nub of the issue – discussed first in 2011 with the four options, and highlighted by the Department in the meeting of 10th June, 2019 as a critical concern – seems to be a relative non-priority in this suggestion adopted by the Land Protection Team, to be ‘studied’ at a later date. We discuss this approach below in our analysis. In either case, this proposed process was to be completed by June, 2020, with the Secretary of the Department indicating that he ‘will delegate a team to do this work and appoint a committee to interact with’ the Land Protection Team.³⁹⁸ The records do not indicate if the work proceeded accordingly. At this time, the Secretary-in-charge wrote to the Department on 12th February, 2020 requesting ‘interim orders preventing ... unauthorized construction and development [in the Masterplan area on privately owned lands] till a Master Plan is prepared by the Villupuram District Planning Authority for the bio-region comprising Bommayarpalayam, Irumbai, Kottakuppam, Mathur and Rayapudupakkam village panchayats’ as they are ‘not in consonance with ... the Auroville Master Plan ... and also in violation of the [2003] G.O.’³⁹⁹ The legal basis for this request, however, is unclear: the Masterplan is not binding for privately owned lands, as the Working Committee noted in its letter to the Department on 14th November, 2019,⁴⁰⁰ and Auroville chose not to activate the 2003 Government Order, which required land plan schedules to be sent by the Foundation to trigger protection. As far as we are aware, the Department did not accord protection and the matter seems to have rested since. Most recently, in its 58th and 59th meetings in November, 2021 and January, 2022, the Governing Board took up the issue:

The Board also endorses the proposal to engage with the Tamil Nadu Government for the establishment of a New Town Development Authority (NTDA) for the Auroville Master Plan area.⁴⁰¹

The regular meetings with officials of the Tamil Nadu Government for the acquisition of city lands & the establishment of a New Town Development Authority (for land use regulation) are in progress.⁴⁰²

Given this extended negotiation between 2003-2023, with varying proposals, shifts in the policy stance and seemingly parallel work streams, it is necessary and urgent for Auroville to adopt a coherent and settled strategy to secure the NTDA option. The primary reason for the

³⁹⁷ Report of the Land Protection Team, 2020, 1-2. ‘Summary of Meeting with Mr. Rakesh Lakhoni, Secretary, Housing and Urban Development Department’, 9th October, 2019. This document does not have an author, and we could not verify its authenticity. It is reflected in the report.

³⁹⁸ ‘Summary of Meeting with Mr. Rakesh Lakhoni, Secretary, Housing and Urban Development Department’, 9th October, 2019.

³⁹⁹ Secretary-in-Charge, Auroville Foundation, 12th February 2020, 1. *See also*, Secretary-in-Charge, Auroville Foundation, 7th February, 2020, requesting the proposed District Planning Authority of Villupuram to develop and approve a Masterplan for ‘the bio-region of Auroville’.

⁴⁰⁰ Working Committee, 14th November, 2019.

⁴⁰¹ 57th Meeting of the Governing Board, 2021, 5.

⁴⁰² 58th Meeting of the Governing Board, 2022, 5.

hesitance appears to be the threat of political influence jeopardizing the planning process within Auroville.⁴⁰³ For this, a closer look at the 1971 Act is helpful.

b. Analysis of the 1971 Act

The NTDA option would make the Auroville Foundation (along with political representation from the State Government) the planning authority for the Masterplan area (in the ‘narrow’ option) and the bio-region (howsoever defined, in the ‘broader option’), thus ensuring that private development in and around the township could unfold in conformity with the Masterplan and other local and regional development plans as may be prepared in time. This includes broad powers to inspect and remove unauthorized development under GO No. 195/2022.⁴⁰⁴ This is important for (i) the ‘city’ area, where strategic land parcels are yet privately owned and can hinder development of key urban infrastructure, (ii) to secure harmonious land use in the Green Belt,⁴⁰⁵ particularly important from an ecological, water management and food security standpoint and (iii) for integrated development with the bio-region. The following maps from 2015 demonstrate the rapid pace of private development as against the proposed Masterplan area, demonstrating the pressing need for legal protection.

⁴⁰³ Auroville Foundation Annual Reports, 2012-2018. Bertrand / NTDA Task Force, ‘Report to the Secretary’, n.d., 19 (‘affairs. The idea that an outside Authority may take over the Planning and Development of Auroville, intruding into the Auroville’s sacrosanct fundamental values, has created apprehension in the community).

⁴⁰⁴ Government Order (Ms.) No. 195, 2022.

⁴⁰⁵ The 2015 Green Belt Land Use Plan, yet to be notified, observes: The State of Tamil Nadu is the formal owner of land designated as ‘poramboke’ used for unpaved roads, rainfall runoff drainage and grazing. Some poramboke has also been encroached for buildings and waste disposal. Within the Green Belt, however, almost 75 % of the land is in private hands, consisting of farms, woodlands, waste lands, water bodies and a growing number of residences, many of which are termed ‘farms’, but in reality small bungalows on subdivided, usually gated areas with attached gardens. This conversion of land in a rural setting to semi-urban uses is a prime concern for Auroville, and forms the impetus for the preparation of this plan, and the seeking of authority as a New Town to control land uses. Auroville is very determined to protect the green belt from development, and to use its planning area as a demonstration of land restoration and sustainable living. In the past, there was no formal plan for the Green Belt. Owners were almost completely free to build on their land. There are laws against the conversion of agricultural land, but these have been rarely enforced. This plan will provide a formal and accepted mechanism for enforcement.’

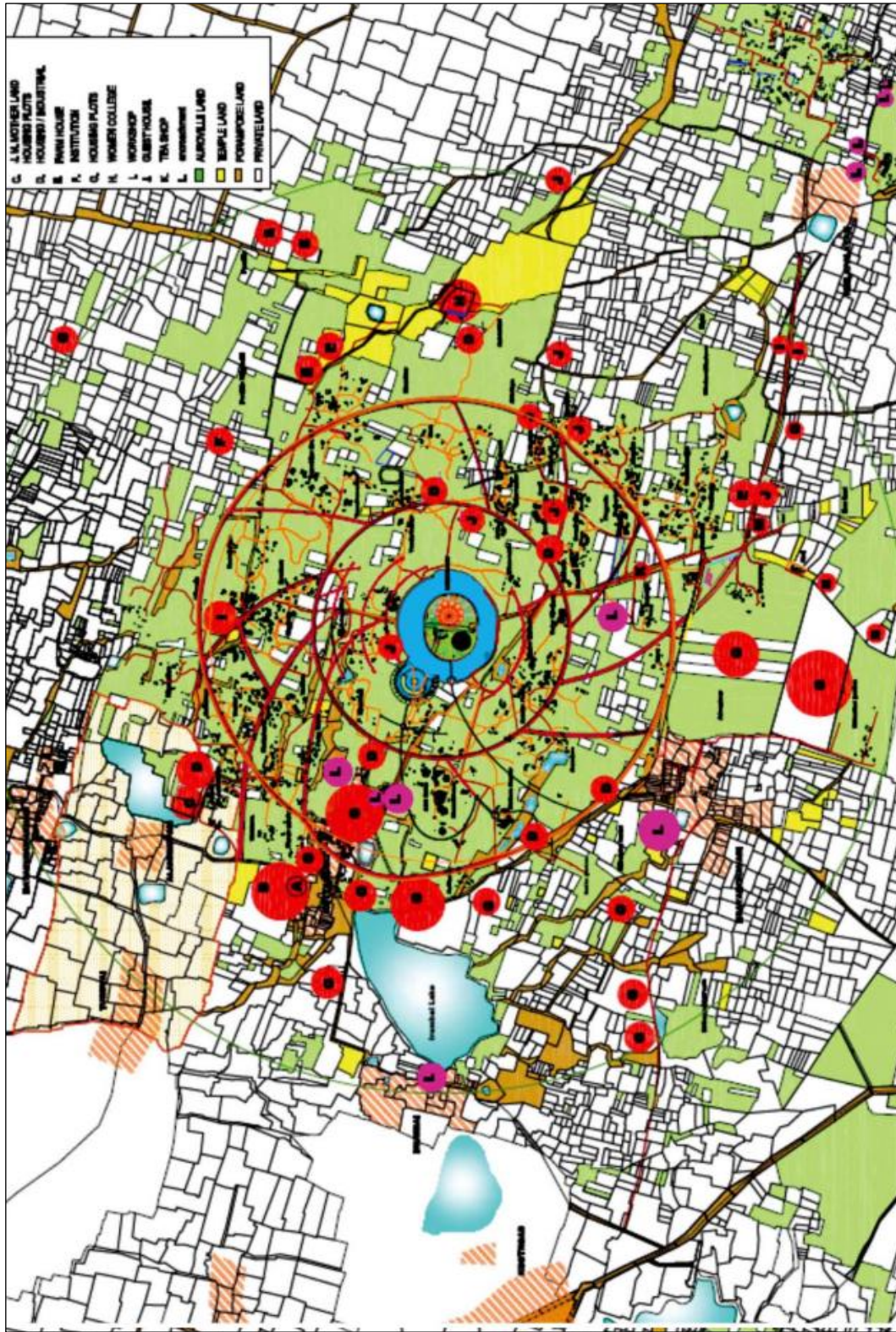

(Proposed boundaries of the Masterplan area. *Source:* Town Development Council, Presentation on the NTDA for the District Collector, Villupuram, 27

The TCP Act, 1971 regulates the establishment of ‘development authorities’, which include local planning, regional and new town development authorities. An NDTA would be an independent corporate body under Section 8, with the following membership under Section 11(4): a chairman to be appointed by the Government, the chairman of the regional planning authority concerned or a member of the regional planning authority nominated by the chairman, the Deputy Director of the Town and Country Planning department of the region, four persons nominated by the state government, including the member of the State Legislature in whose constituency the NTDA falls, and a member-secretary to be appointed by the State Government. The functions and powers of the NTDA are listed in Section 12, which requires it to: (i) carry out surveys, (ii) prepare a New Town Development Plan, (iv) carry out works contemplated in the New Town Development Plan, Masterplan and the Detailed Development Plan, and (v) to provide water, electricity, gas, sewerage and other services, amenities and facilities. This New Town Development Plan, which is subject to the approval of the State Government who may modify it as it deems fit under Sections 24 and 28, is to consider the following matters:

(a) the manner in which the land in the planning area shall be used; (b) the allotment or reservation of land for residential, commercial, industrial and agricultural purposes and for parks, play-fields and open spaces; (c) the allotment and reservation of land for public buildings, institutions and for civic amenities; (d) the making of provision for national highways, arterial roads, ring roads, major streets, lines of communication including railways, airports and canals; (e) the traffic and transportation pattern and traffic circulation pattern; (f) the major road and street improvements; (g) the areas reserved for future development, expansion and for new housing; (h) the provision for the improvement of areas of bad layout or obsolete development and slum areas and for relocation of population; (i) the amenities, services and utilities; (j) the provision for detailed development of specific areas for housing, shopping, industries and civic amenities and educational and cultural facilities; (k) the control of architectural features, elevation and frontage of buildings and structures; (l) the provision for regulating the zone, the location, height, number of storeys and size of buildings and other structures, the size of the yards and other open spaces and the use of buildings, structures and land; (m) the stages by which the plan shall be carried out.

The State Government may under Section 22 direct the NTDA to prepare such a plan by a fixed date, subject to the approval of the Government and with powers to ‘make such modifications ... as they think fit’ and under Sections 28 and 24. It bears emphasis that any prepared plan may be revoked or modified under Section 32(4), either through a regular five yearly review, or unilaterally by the State Government. The advantage of an NTDA, naturally, is that, as Section 36 stipulates, any land notified under the NTDA ‘shall be deemed to be land needed for a public purpose within the meaning of the Land Acquisition Act ... and may be acquired under the said Act’, and, for the notified land, Chapter VI prescribes an approval process for development of land, and proscribes any development in the area otherwise than in conformity with the development plan, with a power in Section 56 to remove unauthorized construction.

In addition to this general scheme, Chapter V provides for special provisions for NTDA's. Notably, (i) while the NTDA can enter into any agreement or contract ‘with any local authority, local planning authority or statutory body in order to secure the provision of services, such as

water supply, drainage including sewerage, electricity, gas within the area of the new town', this is subject under Section 41 to the power of the State Government to modify or disallow such agreement or contract; (ii) the State Government may make advances and payments to allow the NTDA to defray capital expenditure, (iii) the NTDA has the authority borrow money from any public corporation, and enter into financial arrangements subject to conditions prescribed.

The concern with non-harmonious development in the plan area, and the immediate vicinity, is a major concern for Auroville in several respects. First, a rapidly changing socio-economic dynamic in the bio-region, owing in part to spill-over effects from Auroville's own development, has attracted developers to Auroville's vicinity. The priority economic concerns for residents of villages in the plan area have naturally led to growing speculation, and absent remedial action, the danger of an uncontrolled flow of capital and hap-hazard development presents an existential risk for Auroville. Second, this unchecked flow of development has adverse effects for local cultural heritage. These concerns have regularly featured in community discussions and expert reports – for example, in the 2015 Auroville Retreat,⁴⁰⁶ but no clear implementation plan has resulted since. The 2018 Growth Management Framework Report presents a summary of these concerns:

The most common concern revealed through the interviews and fieldwork research was unmitigated development. An Auroville planned note that developers (both local and foreign) within the Auroville area are building without consideration to local form or custom. New buildings tend to stick out. Interviews and focus groups conducted with village resource persons revealed that the local villages are facing a loss of cultural heritage.

There are no existing regulations with respect to physical design or public infrastructure like transit, roads or water. Developers are building without consideration to local vision or long-term needs. The current developments are short term in vision, as they do not factor in the benefits of sustainability or the long-term effect of loss of cultural heritage. Based on interviews and focus groups, there is no movement towards regulating developers from a physical design perspective.⁴⁰⁷

Given the statutory scheme outlined above, the following considerations emerge in relation to the viability of an NTDA, which we weigh against alternatives in the next section.

First, securing a sound representation formula for Auroville: the constitution of the NTDA comprises seven members, a chairman, the chairman of the regional planning authority (which we have been informed has not yet been constituted for the area, but must figure into future calculations), the Deputy Director of the TCPO and four members, one of whom is the local member of the state legislative. In such a case, the viability of the NTDA will depend on arriving at a formula for appointment with the State Government that secures a majority of Auroville residents / nominees or those aligned to Auroville's aspirations. As the records discussed above indicate, the State Government appears – as the NTDA Task Force and others note – to be amenable to a representation formula that will allow these objectives to be met. As

⁴⁰⁶ See, for example, Full Report, Auroville Retreat, 2015, 21, 33.

⁴⁰⁷ Evangelista et. al., 2018, 62.

we discuss below, this is not a *de jure* guarantee; yet, if managed well, it is sufficient to secure Auroville's interests and assuage valid community concerns with external 'interference.'⁴⁰⁸ The Department's last letter of 15th July, 2016, wanting to 'immediately' finalize an NTDA the 'objective of which will be to preserve and promote the ethos of the Auroville International Township' offers indeed as great a signal of support from the State Government as one could hope for.⁴⁰⁹ Similarly, in the 10th June, 2019 meeting, the Secretary noted that 'for the remaining five (max) members there is flexibility and Government can work with Auroville Foundation in finding the right persons. It is important to work on the details.'⁴¹⁰

The following may be viable models in this context. The three other members identified in the 1971 legislation may comprise chairperson of the TDC, a representative of the local panchayats and to secure a majority, a third representative from Auroville. Naturally, the presence of the Chairman of the Governing Board, an individual of eminence and respect (or his nominee, which is likely, as the work of the NTDA makes it unlikely for the Chairman, usually occupying a position of eminence elsewhere, to devote the necessary time), as the chairman of the NTDA will assist in a cordial relationship between the various stakeholders. The good offices of the Governing Board and the International Advisory Council can further secure this cordiality. Moreover, the presence of non-Auroville residents, the Deputy Director, TCPO, chairman of the Regional Planning Authority, the local panchayats and the member of the State Legislature is, in the ordinary course, a natural interchange that will occur even outside the NTDA. It cannot be avoided, as many suggested, nor, we may note, should it be: an engaged and collaborative working with regional actors is necessary for the long-term health of Auroville's integrated development. Rather, the NTDA may focus those energies and concretize these relationships for collaborative working within the framework of the body, subject to norms of public accountability that will place pressure on unbecoming elements in the bio-region. Moreover, as we discuss below, absent an NTDA, Auroville is currently required to obtain permissions from the TCPO / panchayats – all else being equal, an NTDA is preferable.

Second, concretizing local political engagement: the concern often voiced that the inclusion of a political representative will politicize the process is valid. Yet, these concerns will arise in any case as a result of the member's political activity in the constituency, which will only increase with Auroville's development given higher stakes. Indeed, an NTDA – on which he is only one member, and without a majority – may for a structured and meaningful engagement in the presence of the Chairman, Deputy Director, TCPO and others. This is, at any rate, a manageable concern. Here, as elsewhere, a proactive liaison with the State Government and local panchayats will be essential to ensure that relations are cordial and collaborative.

⁴⁰⁸ The NTDA Task Force records the key concern that appears to have held up the proposal: 'In his request to prepare a NTDA proposal, solely for the Auroville area the Secretary has followed to the letter, the request of Auroville. In that regard Auroville can hardly expect a greater conciliatory collaboration from the State. But, however willing the Government is to ensure that Auroville will maintain control over its planning and development, this proposal, limiting the Authority's sphere to the sole Master Plan area, has raised concerns within the Community, worrying about interference with Auroville development. It is felt that unless Auroville can be guaranteed a perennial majority in the Planning Authority, Auroville's aims and value may be jeopardized.' Bertrand / NTDA Task Force, 'Report to the Secretary', n.d., 22.

⁴⁰⁹ Secretary, Housing and Urban Development Department, 15th July, 2016,

⁴¹⁰ 'Notes from meeting with Secretary, Housing and Urban Development', 10th June, 2019.

Third, institutional platform for collaboration with the TCPO: the presence of the Deputy Director of the TCPO will be a helpful input to allow for planning concerns in the area to be addressed systematically through a closer, formal collaboration between Auroville and the TCPO. This will among other things bring with it external expertise, as in the case of the 2001 Perspective Masterplan, and a greater regional reach. As the 2018 Growth Management Framework Report notes, based on discussions with members of the State Government and planning authorities, they would welcome a closer working relationship with Auroville, which the NTDA facilitates institutionally, without the current over-reliance on individual contact.

Fourth, residual powers of the State Government: the next risk to be considered here is the power of the State Government to approve and unilaterally amend plans submitted by the NTDA. This seems to have been under-appreciated in the records on this issue. This presents, in principle, a risk of handing over the final decision over developments in Auroville to the State Government even if the Foundation secures a majority representation on the NTDA – the text of Section 22 and 32 is unambiguous on this point; again, a trade-off must be considered here, as in the usual course of developments, a regional / local planning authority for the Auroville region is likely due in time with growing socio-economic developments and Auroville may be well advised to institute this relationship early, to secure a cordial relationship. That said, this is a clear risk factor not only in relation to the bio-region, but Auroville owned-lands, which will be equally subject to the State Government’s final approval.

Fifth, impetus to development: an NTDA would require Auroville to prepare and execute in the timely fashion a new town development plan, masterplans, detailed development plans – given historical concerns over these matters as we have considered above, the NTDA will give a fresh and strong impetus towards this development, and push Auroville to formalize both its own detailed development plans and work with the panchayats to develop theirs in an integrated manner, contemplated under the 2014 TDC MOUs discussion below. This will be a welcome development that creates a formal mechanism to deal with the Rurban ideal outlined in Part I.B.

Sixth, enforcement of land use regulation: Chapter VI provides the NTDA powers to regulate land use with developments above 4000 sq. ft. subject to an approvals process under Chapter VI, with powers to remove unauthorized developments.⁴¹¹ This is the primary benefit of the NTDA: it creates disincentives for speculation and unchecked commercial developments in the region that threaten Auroville’s vision of integrated development, present environmental concerns, trigger adverse socio-economic changes by way of gentrification, inflate market-price of lands and place pressure on local cultural heritage.

Seventh, managing aspirations for integrated development: it is also important to note that an NTDA not only allows Auroville to prevent non-harmonious development, but places a *positive* obligation to ensure development to serve the socio-economic interests of the residents of villages, a significant responsibility that comes with the NTDA. Mr. Doshi’s letter to the

⁴¹¹ Till this limit, panchayats can grant approvals in accordance with the Masterplan. For developments above, an NTDA approval is required. This figure and nature of delegation is subject to administrative orders of the Housing and Urban Development Department issued from time to time.

Department in 2015 recognized, and welcomed, this consequence. In particular, the NTDA takes on the responsibility to provide water, electricity, gas, sewerage and other services, amenities and facilities. The limits on the village residents' freedom that arises owing to the NTDA will lead to disaffection if these benefits are not instituted. As such, a choice will need to be made as between the TDC's proposal in 2016 for a 'smaller NTDA' and the Secretary's 2019 proposal for a 'broader NTDA', based on Auroville's capacity constraints, aspirations for integrated regional development and the relative ease of securing an NTDA for the smaller region. While an integrated development approach would support a broader NTDA, such that Auroville can lead regional planning, capacity and governance concerns within Auroville may not render this feasible in the short-term.

Eight, acquisition of remaining lands at current densities: securing an NTDA opens up the possibility of land acquisition for the last remaining lands in the city-area, and of a capital infusion from the state government. It also bears noting that at its current density levels, Auroville has limited leverage to garner governmental support for land acquisition or harmonious development in the bio-region (a point made by the State Government since 2003),⁴¹² which presents another reason to secure the New Town Development Authority.

c. *Weighing Options*

There are, as far as we can see, five alternative options to the NTDA.

The first option is an amendment to the 1971 Act, of the form of the 2022 amendment to the Act to constitute urban development authorities for Madurai, Coimbatore, Tirupur and Hosur / *sui generis* legislation of the Tamil Nadu State legislature, a *lex specialis* for Auroville / constitution of a 'special development authority'. This was proposed by the 2020 Land Protection Team. It is a permanent, best-case solution but politically unlikely:

... [the] option of making an amendment to the Town and Country Planning Act was not recommended by the Commissioner of Town and Country Planning that preferred instead the constitution of an NTDA.⁴¹³

Other solutions were evaluated like for example the constitution of a Special Development Authority; as it happen in other States, but this would require an amendment to the existing law, because it is not foreseen by the existing legislation of Tamil Nadu.⁴¹⁴

Van Megen registers a different view in this regard:

Time and again well wishers of Auroville including legal and administrative experts have advised against this option of an amendment to the Tamil Nadu Town and Country Planning Act, or the legislation of a new act, as some have proposed, in

⁴¹² See, for example, General Meeting, Residents' Assembly, 2022, 236. This concern had been voiced from the early years. For example, Guigan, 2018, Vol. 2, 167 provides the transcript of a conversation between members of the Committee for Auroville's Administration and some Aurovilians at aspiration in 1970 when tension arose after a request from the Sri Aurobindo Society to the Tamil Nadu Government to acquire 130 acres – one member pointedly notes: 'I wanna know for myself how I can, may be the way you are doing it, justify land expansion when we are not utilising the land we already have ...'

⁴¹³ Report of the Land Protection Team, 2020, 4.

⁴¹⁴ TDC, Memo on NTDA, 2015, 1.

particular if this amendment or new act would serve primarily, or only, the purposes of Auroville. An amendment to the Tamil Nadu Town and Country Planning Act had been contemplated by the Government of Tamil Nadu some years ago but this idea was dropped and the commission that was established to draft the amendments was dissolved.

...

The issue is not about ‘legal planning powers’ but about the regulation of land use in the Auroville master plan area irrespective of land ownership. Today Auroville is required to take land development permissions from the local Panchayat or the Director of Town Planning depending on the extent of the proposed built-up area. In the case of a New Town Development Authority (NTDA) that authority would have to be approached instead.

...

Therefore if the Tamil Nadu Government is willing to establish an NTDA that will go by the land use as envisaged in the Auroville Master Plan, the purpose of Auroville is served in this regard. The Tamil Nadu Government has already expressed on several occasions their readiness to proceed with such NTDA establishment in close consultation with the Auroville Foundation. The question of an amendment to the Tamil Nadu Town and Country Planning Act would only arise if the existing act does not have a provision for land use and development regulation such as provided by an NTDA.⁴¹⁵

The distinction between ‘legal planning powers’ – the phrased used by the ‘Core Group’ and taken forward by the ‘Land Protection Team’ – and land use regulation is important to clarify in evaluating the NTDA option. Auroville is currently required to take permissions from the relevant authorities as matters stand on the same footing as development on privately owned lands. As Van Megan notes, an NTDA would simply substitute the authority from which permissions are taken, rather than remove that requirement. Moreover, there is – as the NTDA Task Force rightly notes – a ‘flawed’ ‘perception of independence’ and ‘misperception of the extent of Auroville ‘liberties’ among Aurovilians’: under the current state of affairs, absent an NTDA, Auroville is equally bound by legal requirements to obtain permissions from the Director, TCPO or the relevant *panchayat*.⁴¹⁶ NTDA substitutes the Director / panchayats as the planning authority, on which Auroville will in any case have greater representation than the current dispensation. As such, the concern with independence is currently greater than with an NTDA, even if the latter does not alleviate it entirely.

A NTDA will thus secure Auroville’s planning interests, such that an amendment is unnecessary, provided that two conditions are met.⁴¹⁷ The first condition is that the NTDA can be secured with a majority or aligned representation for the seven members from the Foundation, as we discuss above. The Department’s suggestion that it appoint members ‘in close consultation with the Auroville Foundation’, mindful of Auroville’s unique needs, is not

⁴¹⁵ Van Megan, 2018, 1.

⁴¹⁶ Bertrand / NTDA Task Force, n.d., 19.

⁴¹⁷ These have been recognized since 2012, and negotiated with the Department in discussions in 2016. *See*, TDC, Memo on NTDA, 2015, 1-2.

a *de jure* guarantee, yet if this proposal is considered to be such that the members of the NTDA are attuned to Auroville's unique needs, even if not its residents, this condition is satisfied.⁴¹⁸ The Department's 2016 letter and the 2019 meeting both confirm this. There are two options to operationalize this arrangement: the first is an informal agreement that appointments will be made jointly or in consultation, and the second is a formal guarantee – by way of a Government Order, though revocable, as indeed with any administrative instrument under the 1971 Act – that appointments will require joint concurrence for the five members, excluding the *ex officio* positions. The latter was requested by the TDC in 2016 and would naturally be preferable, yet the former too can secure Auroville's interests if worked collaboratively. Past practice gives good reasons to believe so – as the NTDA Task Force noted, and the records demonstrate, the Housing and Urban Development Department / State Government and TCPO's sympathetic and accommodating attitude towards Auroville, if matched with robust internal governance processes and bio-regional liaison, can ensure that this consultative process can secure Auroville's interests *and* deepen regional ties. An amendment to the 1971 Act will be beneficial only if the statutory right to appoint members, or a majority of them, to the NTDA / 'special planning authority' created under statute is granted to the Foundation, or if the Foundation itself is by statute declared to be the planning authority. These seem unlikely and unnecessary. In the long-run, an active and strong planning relationship with the bio-region is necessary for integrated development, for which collaboration with local panchayats, villages, the TCPO and Department / State Government is key. The second condition is that the NTDA declares the Perspective Masterplan (or any subsequent document prepared in its place) as the reference document for the plan area. Both of which were agreed upon by the Department in the communications dated 19th March, 2016, 15th July, 2016 and 10th June, 2019.

There is however a further risk with an NTDA not discussed in the correspondence / internal reports under Sections 24, 28 and 32(4) of the 1971 Act which provide the State Government the power to approve a new town development plan and alter or revoke it at any time. An appropriate amendment to exclude Auroville, again unlikely, may in principle offer a *de jure* guarantee. However, this is a residuary power that we are given to understand is rarely exercised and unlikely in Auroville's case, particularly given the Department and TCPO's accommodative and positive engagement over the years. With strong internal governance, effective government liaison and robust bio-regional linkages with the local panchayats, this remote political risk may be alleviated without a statutory amendment. Indeed, a collaborative relationship with the Department / State Government to strengthen ties, rather than a defensive one to entirely insulate or remove Auroville from the legal regime of Tamil Nadu, is a valuable long-term approach for future development and planning.

In any case, the NTDA and an amendment not mutually exclusive, such that an NTDA can be secured today to secure Auroville's interests substantially, without waiting for an amendment,

⁴¹⁸ TDC, 19th March, 2016, 3 requested appointments be made 'jointly', which was accepted as per the records. See also, TDC, Memo on NTDA, 2015, 2 ('According to the Town and Country Planning Act of Tamil Nadu there are four non ex-officio members of the NTDA to be nominated by the Tamil Nadu govt. In order to achieve the objective highlighted in the previous point it will be helpful if they are nominated in consultation with the Auroville Foundation or in any case a relevant representation from the Auroville Foundation is ensured.')

which may be pursued in the future if and when necessary. There appears to be some confusion in the records on this count: the Core Group and later, the Land Protection Group proposed a delegation ‘of legal planning powers’ and a ‘delegation of competence that may be obtained through an amendment to the Town and Country Planning Act would allow more flexibility even if, to date, the legal implications of such a possibility are rather remote’. The nature of this proposed delegation is unclear, as an NTDA *already* has a statutory right to regulate land use and development in accordance with the new town development authority plan, such that flexibility is ensured. Delegation under Section 91 relates to powers of the Central Government and Director – these may pertain to instances of permissions or approvals required under administrative or government orders made under Section 122 from time to time, but this is a minor matter, on which the viability of the NTDA for Auroville is not materially dependent. Insofar as the State Government’s powers under Sections 24, 2 and 32(4) are concerned, they cannot be ‘delegated’ either under Section 91 or a statutory amendment; rather, they can at best be circumscribed to remove or alter the residuary power under these provisions in relation to the NTDA – as we note above, this is political unlikely and, in any case, strategically unnecessary to secure Auroville’s interests.

It is useful to reflect here on the proposal of the Land Protection Team, which marks a different stance from earlier correspondence between 2003-2019. As we noted above, their suggestion was that the process be ‘reversed’, i.e., instead of notifying the plan area through an NTDA, and then preparing plans and holding consultations, Auroville would first prepare a land use plan in consultations with panchayats and village residents then the ‘agreed and approved document would then be endorsed by the State as the land use and development plan for the township area and the mode of enforcement will be assessed and studied at that time’, including a ‘mutually acceptable mode of review and /or consultation with the Auroville Foundation for the issue of NOC within the master plan area with the local authority.’⁴¹⁹ Three points may be made here.

First, the core issue to safeguard non-harmonious development in the plan area, or the broader bio-region (depending on whether one takes the limited to extended NTDA option) is to have a planning authority on which the Foundation is represented and to designate the Masterplan / new town development plan drafted by such authority (of which the Auroville Masterplan will be a core component) as the land use document against which approvals are given. The ‘mutually acceptable mode of review and / or consultation’ / NOC process that the Legal Protection Team refers to, yet defers to a later stage, is the *key* issue to prevent non-harmonious development. An NTDA offers a legally enforceable option to this end, and as such, there are good reasons to secure it not at the end of the process as the Team recommends, but at the beginning. Waiting for a collaborative land use plan to develop – an activity that will likely take some time – means, as the Secretary to the Department noted on 10th June 2019, and the Secretary of the Foundation noted on 12th February, 2020 means that till that time, there is *no* legal protection for privately owned lands on the plan area for any development.

⁴¹⁹ Report of the Land Protection Team, 2020, 5.

Second, the reversal is, all else being equal, sub-optimal: once an NTDA is secured, the 1971 Act mandates that a new town development plan is to be finalized within one year (or as indicated by the State Government) – in this process, the first two steps for collaborative, plot level planning suggested by the Team can be effectively conducted with legal backing and a sense of urgency. As such, the benefits of postponing an NTDA until these tasks are completed is unclear; indeed, an NTDA would provide a legal force and institutional structure to that effect.

Third, the proposal for a ‘mutually acceptable mode of review and /or consultation with the Auroville Foundation for the issue of NOC within the master plan area with the local authority’ is unclear. An NTDA would replace the Director, TCPO and the local panchayats as the planning authority, charged with developing and regulating land use, with powers to remove unauthorized constructions. The legal basis for a ‘mutually acceptable mode of review and / or consultation’ or an NOC from the Foundation is not identified in the Report, and as such, is unclear. Absent an NTDA, if a land use plan is adopted by the local planning authorities, i.e., the TCPO or panchayats depending on the nature of the project, the final power to approve applications would lie with them, not only for privately owned lands but also lands owned by Auroville in the plan area. All else being equal, an NTDA offers strong protection for Auroville for the plan area, on lands owned by it or privately. Indeed, the Team’s recommendation here is not new – it was suggested, amongst other options, previously by the February, 2014 report of the Land Protection Status Study Group.⁴²⁰ It suggested after a thorough analysis, that the NTDA option, where Auroville would have representation, would serve Auroville’s interests better than *ad hoc* or non-binding measures, such as ‘reviews’ and ‘consultations’, or NOC processes secured, we assume, by the letter of the Assistant Director dated 20th June, 2011 or a another administrative instrument. In these two cases, the regulatory power lies with the Director, TCPO / *panchayats*, on which Auroville has no representation. The important question here is the statutory basis for enforcement of land use – an NTDA offers the best route to that end, and allows in time, for detailed development plans of the kind anticipated by the Team to be prepared in a collaboration. As such, the Team’s recommendation for collaborative planning with the panchayats and villagers is important, yet its relative dis-emphasis on the precise nature of legal protection to serve these interests requires reconsideration.

The second alternative option to the NTDA is securing an exemption from the State Government / Department under Section 113 of the 1971 Act, which stipulates that:

Notwithstanding anything contained in this Act, the Government may, subject to such conditions as they deem fit, by notification, exempt any land or building or class of lands or buildings from all or any of the provisions of this Act or rules or regulations made thereunder.⁴²¹

⁴²⁰ Land Protection Status Study Group, 2014; *see also*, Ven Megan, 2018, 3-4, for strong, but fair, remarks on the issue (‘It appears that the Land Protection Group has not worked on any new or alternative solutions with a sense and comes back with a set of general statements that are not much different from most other groups that had been established to look into the subject matter ... We have to sadly conclude that instead of protecting the lands of Auroville, groups are formed and studies are made only to keep the conversations and debates going. Quite clearly there is no sense of urgency while private land speculators continue to have a field day.’)

⁴²¹ Section 113, Town and Country Planning Act, 1971.

Instead of an amendment to the 1971 Act itself, which is politically unlikely, a Government Order to exclude lands in the plan area may be considered under Section 113. This power was exercised in 2012 in relation to the Atomic Energy Department in Mamallapuram, which excludes it from the jurisdiction of the local planning authority. This option was suggested by the NTDA Task Force, for a broader NTDA within which the plan area would be excluded under Section 113:

This solution that would reconcile the need for self-determination, necessary in a project like Auroville, while giving the State an unobtrusive right to be the guarantor of its success, if obtainable, is the foremost solution ... If such a configuration is to be achieved it would allow Auroville to plan its Township in its own term while maintaining a collaborative participation in the larger NTDA.⁴²²

Five points may be made in this regard. The first is that any order under Section 113 would, just as the NTDA or the current situation under the Directors / panchayats, be subject to the alteration or revocation by the State Government, and as such, the demand for ‘perennial’ independence – ‘howsoever flawed’ – is not tenable.⁴²³ Second, the nature of the exemption needs to be defined: whether it is from the jurisdiction of the NTDA entirely, from provisions concerning control and development of land use under Chapter VI, or from the approval powers under Sections 28, 28 and 32. Third, in any case, an exemption of this sort under Section 113 would be *sui generis* as we were not able to locate any similar exemptions.⁴²⁴ From the records, this seems politically unlikely. Fourth, Auroville may secure these objectives through a delegation of powers by the NTDA under Section 91-A, which is more likely and has already been proposed by the Department, rather than asking for an exemption from the jurisdiction of the NTDA itself under the 1971 Act itself.⁴²⁵ As such, Auroville may best serve its interests by securing an aligned majority through common / consultative appointments to the NTDA for the plan area / ‘extended area’, with necessary delegation of Chapter VI powers to the Foundation / TDC, without requesting an exemption. Fifth, Auroville’s bargaining power to have representation on the NTDA and contribute to / control bio-regional planning, when it has exempted itself from its jurisdiction is a matter of concern. Its political and legal tenability aside, this may be perceived as exceptionalism and lead to adverse implications for integrated planning and local cultural relations.

The third alternative option to an NTDA is a notification of the Masterplan by the State Government, but with planning and enforcement authority vested in the District Administration under Government Order No. 1730 of 1974 or an appropriate instrument. This would allow for

⁴²² Bertrand / NTDA Task Force, n.d., 20.

⁴²³ Bertrand / NTDA Task Force, n.d., 19, 22.

⁴²⁴ The Mamallapuram precedent was first invoked in 2002. The Special Commissioner of Town and Country Planning, 1st July, 2002, 2 noted: ‘Similar provision is already available in Mamallapuram Local Planning Area in which Department Atomic Energy has its own jurisdiction and Mamallapuram Local Planning Authority exercises no control over it.’ The concerns animating the exemption for the Atomic Energy Department were naturally different, and yet may offer precedent. It seems that this is unlikely, given any lack of movement on this from 2002 onwards in the records or discussions, other than the mention by the NTDA Task Force in 2015. We are unaware of any other city-wide exemptions under Section 113, but this will require verification.

⁴²⁵ This was the TDC’s view in 2015. TDC, Memo on NTDA, 2015, 2 (‘The Town and Country Planning Act provide for various type of technical association or delegation of power and the Auroville Town Development Council could be an NTDA’s main partner in the planning and development of the Auroville Master Plan area.’)

non-harmonious development to be regulated in the plan area, yet planning decisions and interpretation of the Masterplan will lie outside the Foundation. This may be supplemented with an NOC requirement from the Foundation. The letter dated 20th June, 2011 issued by the Assistant Director (Village Panchayats) seems to already incorporate this protection, but we were unable to identify whether it has been activated. This is a short-term measure for protection, but for the reasons identified above, not a long-term solution.

The fourth alternative option is a local or regional planning authority, under Sections 11(1) and (2) of the 1971 Act: the NTDA – whether for the plan area or the ‘broader’ option – stands as a suitable *via media*. The regional planning authority will necessarily dilute Auroville’s representation, while the local planning authority will allow for greater representation, yet limit power to guide integrated development in the bio-region. Equally, the residual powers of the Director, TCPO in relation to planning authorities are extensive under Sections 23 and 25, and as such, an NTDA, on which the Deputy Director sits *ex officio* is preferable. The NTDA is thus the best option in terms of mitigating the political risk of external representation and allowing for integrated development of the plan area / bio-region. All other political risks remain constant between these options.⁴²⁶

The fifth alternative is an MOU with village panchayats and the current system of semi-formal collaboration and pressure to counter non-harmonious developments, through Village Development Councils or otherwise. These are a helpful and important measures, but lack teeth. The Masterplan does not legally control land use, and approval and enforcement powers lie outside the Foundation.

Currently, planning relationships with the bio-region are structured along three lines: (i) a substantial outreach architecture comprising social, education, economic and cultural organizations working with the villages, which generates goodwill and a positive connect; (ii) Village Development Committees constituted by the Auroville Village Action Group, to allow for better communication and a structured engagement between the Group and village residents, again a notable move; and (iii) two Memorandums of Understanding signed with Bommayarpalayam and Irumbai panchayats to address the planning and infrastructure development of the villages in the Auroville Green Belt.

The first and second provide the cultural and social architecture that undergirds any collaborative planning arrangement, developed painstakingly over the years by individual enterprise, that can be fortified and expanded under the umbrella of the NTDA. We consider this briefly below. The third – which seem to be the only formal arrangement between Auroville and the panchayats, yet not legally binding as in the NTDA – are the MOUs signed in 2014. These were a notable and timely move to deepen and formalize a mutually beneficial engagement, with the two villages included still designated as ‘backward’. Under the agreement, the TDC committed to provide technical assistance with the development of Village Development Plans, including the deputation of a trained planner for upto six months to assist

⁴²⁶ A ‘composite authority’ to merge local planning authorities, which is mentioned in the correspondence as another alternative, is not a legal entity under the 1971 Act. To the best of our understanding, it will be either a regional or new town development authority.

with development activities. These included environmental protection, modern farming strategies, including organic farming techniques, economic development, health development, sanitation improvements, tourism development, provision of pure water for all, expansion of employment and universal education, along with the provision of necessary support and cooperation for the implementation of waste water management, rain water harvesting, solid waste management and tree planting supported by funds solicited and received from Government, non-governmental organizations and private sources. Reciprocally, the panchayats committed to call panchayat meetings and village residents' meetings to adopt appropriate resolutions for plans and projects proposed by the TDC and implement welfare schemes and projects within the regulations of the TDC. The MOUs were thus an important tool both for village welfare works and the security of Auroville's own development, deepening trust through common action.

As a planning tool, the MOUs present a soft measure for collaboration to prevent non-harmonious development in Auroville's plan area: it does not bind individual owners, who are free to sell or build otherwise absent a legally enforceable policy for land use regulation. The NTDA by comparison is a relatively hard measure, given that planning approvals in accordance with the development plan are mandatory. The presence of a local representative, of the panchayats or member of the legislative assembly as a member of the NTDA, may indeed help ensure that no disaffection results. Till the NTDA is finalized, the TDC may consider reviving work on the MOUs, with a dedicated vertical to ensure implementation as suggested in the Annual Development Plan, 2014-15 ('the TDC Regional Development Anchor'). This is given our understanding that after an initial period of action led by members of the TDC who signed the document, energies to pursue the activities outlined in the MOU have flagged partially owing to COVID, but in large measure to the lack of institutional continuity in the TDC on this point.⁴²⁷ The 2015 Auroville Retreat identified the need to 'setup a process for regular liaison with the local panchayats' by February 2018, 'platforms (online / physical) for information and networking with people working in the bioregion' by August 2015,⁴²⁸ but these are yet to be instituted: the MOUs provide a practical route to work towards these ends. Equally, in the interim, the TDC Annual Development Plan, 2014-15, proposal to request a seat as an 'observer' in the District Planning Committee' may also be taken up to generate momentum.

In sum, the NTDA option offered by the Urban Development and Housing Department in its communication of 15th July, 2016 presents, in our view, the most appropriate policy option in

⁴²⁷ TDC Annual Development Plan, 2014-15, 245 notes on this point: 'Based on this recommendation [of the Green Belt Development Programme] TDC proposes to set up a Town Planning liaison office in each village existing within the township area. A link will thus be created between the village's authorities consisting of the Panchayat, the Elders' Council and the local governmental administration, such as the Village Development Offices, and Auroville's TDC. Ideally there shall be one Liaison for each of the concerned villages: Bommayapalayam, Kottakarai, Edayanchavadi, Kuilapalayam and Allankuppam. TDC Regional Development Anchor will supervise the set up and report to TDC's decision making body on any topic of interest to the whole of Auroville. It is suggested to start with the villages of Bommayapalayam and Kottakarai. It is estimated that the preliminary studies will last 6 months. It is expected at the end of this period that a clear agenda for action will have been prepared. Depending on the results of this test case, the liaison will be initiated in each of the aforesaid villages. A detailed plan to tackle this issue is ready and awaits funding.' To the best of our understanding, work did not proceed along this basis.

⁴²⁸ Full Report, Auroville Retreat, 2015, 34.

comparison with the five alternatives. While the NTDA carries some risks, the pressure of local developments today does not allow Auroville the luxury of avoiding proactive steps or waiting for an ideal solution in the future. The changing dynamic of the bio-region and the threat of unchecked urbanization and speculation in the short-term on Auroville's long-term sustainability requires urgent policy action. Ideally, the strength of Auroville's own internal governance systems, city-planning measures and government liaison ought to be well-placed to manage these inevitable and unavoidable political risks within the legal framework of Section 11 of the TCP Act, 1971. Engagement with other stakeholders in the bio-region is inevitable, including local political pressures and other challenges recorded in the 2018 Growth Management Framework study – as such, the NTDA presents a way to secure this interaction on an even footing within a defined planning framework.⁴²⁹ As the Secretary to the Department noted on 10th June, 2019, the State Government may establish a regional planning authority 'at anytime', which will constrain Auroville's planning efforts. We reiterate his counsel, which is pressing today: 'before that happens it is highly advisable for Auroville to work with the Government on an NTDA so that the specific needs of Auroville can be accommodated to the maximum extent possible.'⁴³⁰

It is important to underscore here the TCPO and State Government's sympathetic and flexible attitude to 'preserve and promote the ethos of the Auroville International Township', which should assuage concerns of 'interference' on the NTDA on this front.⁴³¹ The openness of the Urban Housing and Development Department to work with Auroville to accommodate and support its unique aspirations is amply reflected in the discussions over the last decade, and as the NTDA Task Force noted, 'in that regard Auroville can hardly expect a greater conciliatory collaboration from the State.'⁴³² A reciprocally collaborative orientation to the Department / TCPO, rather than one looking for insulation and suspicious of external 'interference', is thus merited and indeed necessary to secure Auroville's long-term vision of integrated development with the bio-region and Tamil Nadu at large.

Indeed, given historical and serious concerns over Auroville's own city-planning infrastructure, the first port of call to enable a proper functioning of the NTDA would be to secure the internal governance front. This must ideally precede the assumption of the weighty responsibility of engaging an NTDA, both in terms of presenting reasons to the State Government to permit Auroville to take over this work and to secure a Section 91-A delegation. As we discussed in Part III.A, this is a concern, given delays and disagreements over the Masterplan within Auroville. To effectively absorb the work of bio-regional planning will thus require a strengthening of internal institutions. The second need of the hour is to increase, or clearly signal an intention to increase, population numbers, absent which Auroville's claim to represent

⁴²⁹ Evangelista et. al., 2018, 6, 8-9, 38-9,

⁴³⁰ 'Notes from meeting with Secretary, Housing and Urban Development', 10th June, 2019. The document does not record an author, and as such, we could not verify its authenticity. Interviews support the views expressed. A letter from the Secretary, Auroville Foundation, 4th October, 2019 requested a further meeting, but does not mention the previous discussions had with the Working Committee.

⁴³¹ Secretary, Housing and Urban Development Department, 15th July, 2016. Bertrand / NTDA Task Force, n.d., 20-2.

⁴³² Bertrand / NTDA Task Force, n.d., 22.

a majority of the NTDA is unjustified given its relatively low share of population in the region despite being a majority land owner.

The long deliberations on this point, from 2003 to 2023, require final resolution. The matter has been considered at length by the Governing Board, Residents' Assembly, TDC, Working Committee, Auroville Council, Land Protection Status Study Group, NTDA Task Force, Core Group, Land Protection Team and in several community workshops and open sessions. A push to finalize the arrangement and move forward, to act rather than prolong debates, is now necessary. The records indicate parallel tracks, policy reversals and an extended discussion after 2015, when the NTDA option was closely examined and finally offered by the Department 'to the letter'. While robust community engagement and expert inputs are important to arrive at a well-informed and consultative decision, the authority, indeed duty, to decide and act in a time-bound fashion at the end of that process lies with the TDC under Standing Order 1/2019 as the executive body tasked with the implementation of the Masterplan. This will, amongst other things, also provide a necessary fillip to finalize a DDP legally mandated under Section 12(1)(c)(i)-(ii) – as the Land Protection Status Study Group rightly noted in 2013, energizing Auroville's own urban planning and development works, including acquisition of remaining lands, is the best means to secure harmonious and integrated development in the plan area.

iii. Regional Planning Framework

Outside of these bio-regional engagements, there are no regional collaborations with bodies outside the plan area which are equally and intricately connected to Auroville's development. An NTDA – leading to a Regional Planning Authority, the next logical step under the TCP Act, 1971 – may allow for controlled and conscious urbanization in these regions, whilst developing common strategies for industrial, agricultural and conservation efforts that bind the region. This is a critical and neglected planning concern in Auroville.⁴³³ As the Department notified Auroville in June, 2019, the constitution of a regional planning authority is imminent, such that efforts to secure this front are now pressing.

We may refer here to the 2012 INTACH-PondyCAN Report, prepared under an MOU between the TDC, that proposed a Sustainable Regional Planning Framework for Puducherry, Villupuram, Auroville and Cuddalore ('PVAC Report').⁴³⁴ These three regions, taken as a single entity, are located within a 40-kilometre radius of each other and encompass a total area of approximately 2500 sq. kms.

⁴³³ In the passage of the Auroville (Emergency Provisions) Repeal Bill in 2001, a member, who served as the Chief Minister of Pondicherry in 1988, made a strong remark along these lines: 'One mistake which our people are doing is that they are not amalgamating the local people in this big process. This is a big mistake which these people are doing. I have been telling this right from its inception. Can he tell me whether any Pondicherrian has been accommodated in this Foundation so far? Nobody has been accommodated. It's not that we want to have any share over that, but those people who have got interest over ethics. why do they not think in those directions and then try to do it? This is a small suggestion which I would like to make.' Lok Sabha Debate, 2001, 463-4.

⁴³⁴ Kalra et. al., 2012. *See also*, TDC, Report for the Governing Board, 2012, 6.

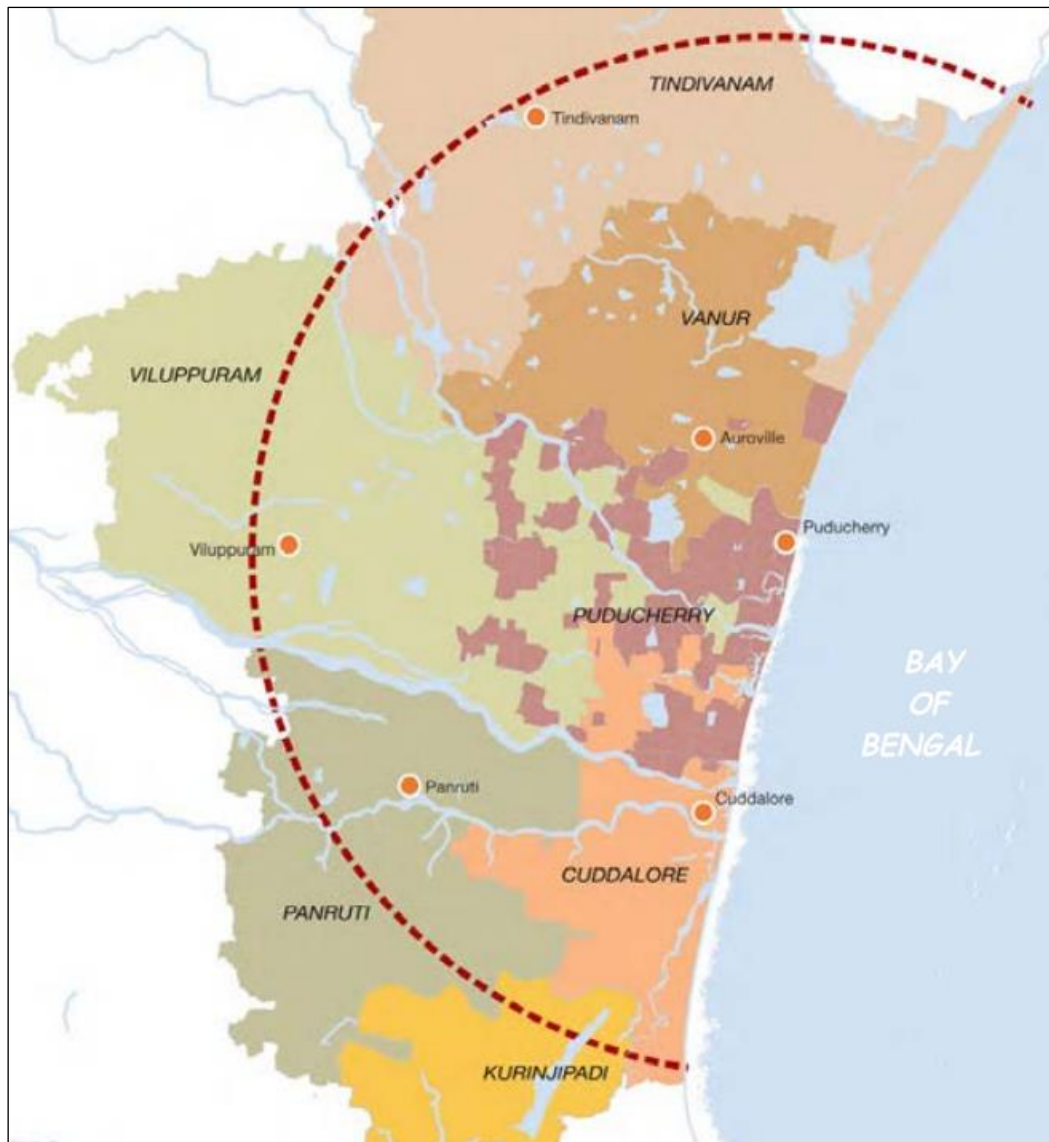

(Regional context. *Source:* Kalra et. al., 2012, 36

We offer a brief reflection to highlight reasons that necessitate urgent action on a regional planning framework.

First, a model for other urban agglomerations: Puducherry, Auroville and surrounding Tamil Nadu districts are an ideal laboratory for a Rurban experiment, to ‘evolve a new paradigm for development’.⁴³⁵ The region is large enough to contain a substantial mix of economic activities, yet small enough so that relatively few changes to the natural and economic landscapes can produce observable trends. Developing regional cluster dynamics – which we discuss in Part III.F – carries significant possibilities, which may generate learnings for a replicable model elsewhere. As the UDPFI Guidelines, 2014 note, a shift from uncoordinated planning between urban clusters towards the ‘region as a planning unity’ is necessary:

⁴³⁵ Kalra et. al., 2012, 10.

Accordingly, planning as an exercise should not be exclusively limited to urban settlements but a region can be identified to have holistic development of growth promoting centres and surrounding subsequent hierarchy of settlements. This should facilitate optimal planning and development of infrastructure in cities along with the adjoining rural areas and strengthen the economic links in the region ... The Planning Commission has also developed methods for regionalisation and policy guidance for preparation of development plans for regions. A number of such case studies have been taken up by the State Governments for development of special regions.⁴³⁶

Similarly, the Niti Aayog noted in 2021:

In a larger context, it needs to be acknowledged that a city does not exist and thrive in isolation. It's regional setting and linkages play an integral role. Therefore, regional planning at the district/metropolitan levels is required for co-ordinated spatial planning, management of physical and natural resources, integrated development of infrastructure, environmental sustainability; efficient mobility, logistics management and so on. These plans further need to be hierarchically linked with the city level master plans for achieving integrated results.⁴³⁷

This includes: sustainability planning – for efficient use of available natural and cultural resources, managing migration and inter-city sprawls, multimodal mobility and equitable spatial and economic development of the region, environmental management – for control of water pollution, use and maintenance of water courses, maintenance of green cover and ecologically fragile areas, disaster management – climate mitigation and adaptation in Auroville's case, balanced economic development – to prevent lopsided development, a rural push due to lack of integrated spatial planning, development of peri-urban and Rurban areas, managing tourism flows etc.⁴³⁸ This is a neglected practice in India, with 'minimal' regional planning efforts – Auroville's efforts in this direction can lead the effort.⁴³⁹ Indeed, the management of shared risks necessitates such an approach:

Puducherry and the surrounding districts of Cuddalore and Viluppuram including Auroville span a total area of roughly 2,500 sq. kms. and constitute an extremely distinct region rich in environmental resources, ecological biodiversity and cultural heritage thus, trivializing the lines that mark the administrative boundaries that divide them. Within this region are four major urban centres- Puducherry, Cuddalore, Viluppuram and Tindivanam and over 500 villages. If unplanned, rapid urbanization of these towns will result in depletion of environmental resources in favour of economic gains and unsettle the urban-rural balance.⁴⁴⁰

This will require an assessment of the appropriate institutional structure for engagement: whether through bilateral collaborations through MOUs with the Local Planning Authorities of Cuddalore and Villuppuram, urban local bodies / municipal councils or corporations / Nagar Palikas / panchayats / State Town and Country Planning Department / Ward Committees at the town, village or even ward level, or district or block-wide administrative structures as the

⁴³⁶ Town and Country Planning Organization, 2015, 109.

⁴³⁷ Niti Aayog, 2021, 80.

⁴³⁸ Town and Country Planning Organization, 2015, 109-10.

⁴³⁹ Town and Country Planning Organization, 2015, 112.

⁴⁴⁰ Kalra et. al., 2012, 15.

Regional Planning Authority or District Development Committee, Block Development Authority / TCPO.⁴⁴¹

Second, ecosystem and environmental concerns: At the ecosystem level, the wetlands of Puducherry and the surrounding districts of Villupuram, including Auroville and Cuddalore, constitute a distinct ecological bio-region. As they are part of an integrated natural ecosystem, a coordinated regional planning approach is necessary for the environmental viability of Auroville's own urban aspirations, particularly in relation to watershed management and coastal management for climate change adaptation. Auroville's material security is tied to that of the region. The PVAC Report highlights the ecological interlinkages and imperative of regional planning:

At the ecosystem level, the wetlands of Puducherry and the surrounding districts of Viluppuram (including Auroville) and Cuddalore in Tamil Nadu constitute a distinct ecological bio-region. The topographically higher wetlands drain into lower wetlands till one reaches the coastal areas rich in bio-diversity. The whole region is part of an integrated natural ecosystem: along the coast are the beaches, sand-dunes, estuaries, forests and mangroves. The natural backwaters and wetlands, along the sand dunes, arrest the water coming down the Deccan plateau through waterways, swales, and rivers. These backwaters play recharge the coastal aquifers, thus providing good ground water and also arresting any salt water intrusion that may occur from the seaside.

...

It is clear now that in case a well articulated regional planning approach and integrated growth management framework is not put in place in Puducherry and its neighbouring Tamil Nadu districts immediately, rapid urbanization and haphazard growth will lead to land under agriculture being usurped for other urban activities. This will have a disastrous effect on the livelihoods of the people that make up this region as well as on the water systems of the area leading to increased runoff, deterioration of water quality and significantly reduced re-charging of aquifer. The intent is to combine the strengths and resources of each sub-region and manage the growth in a way that benefits the entire region and not just the major urban centre of Puducherry. Sharing the region's resources more equitably is the only way that we can build a more sustainable and inclusive regional economy that supports real and long-term growth. It is now absolutely necessary to forge a new understanding that embraces our collective values for safeguarding the environment and our natural resources.⁴⁴²

Similarly, the 2013 Green Belt Development Plan forefronts the need for regional planning to secure Auroville's own food and water security:

... Auroville is a part of a larger bioregion, one defined by the use of a common source of ground water for domestic, agricultural and industrial uses. This groundwater is

⁴⁴¹ For a discussion on the administrative structure of regional planning in India, with proposals, which will inform how Auroville proceeds, see, Town and Country Planning Organization, 2015, 112-3, 116-7. The PVAC Report offers a practical process flow for regional planning in Auroville's context, emphasizing both institutional coordination and local participation to secure a common planning framework. Kalra et. al., 2012, 21.

⁴⁴² Kalra et. al., 2012, 15, 17.

extracted from the two adjacent aquifers, the Kaluveli and the Ousteri. However, Auroville, which occupies less than 2% of the recharge area of these two, is unable by itself to protect these irreplaceable resources. Therefore, the plan calls on Auroville to make use of its unique body of knowledge, developed over the past four and a half decades, to assist the entire Bioregion in the shared task of protecting the water supply on which everyone depends.

...

As a community, Auroville relies on the natural resources of the green belt and the Bioregion for water, for the production of food, wood, associated goods, and climate control. These resources have, in some cases, reached a critical limit of exploitation, beyond which they may be permanently compromised to the detriment of both Auroville and the broader bioregion.

...

Water is the focal concern of the region. Present agricultural practices in most of the region involve the growth of rice, coconuts, sugar cane and farmed shrimp and fish. Each of these is supported by heavy use of water drawn from wells. Studies made by Auroville over the past decade demonstrate that the present rate of withdrawal exceeds the natural replenishment and is depleting the underlying aquifers at a rapid rate. Water tables have dropped from 3 meters to 30 or more meters below ground level, meaning that in some low lying areas, groundwater levels are now below sea level, allowing salt water to begin to flow in from the ocean to fill the depleted zones. Because Auroville and the Bioregion depend on a single shared ground water resource for domestic, industrial and agricultural use, it is imperative that the overall flow within the entire aquifer be properly managed.⁴⁴³

Third, unchecked urbanization and mobility concerns: A changing socio-economic profile of these regions risks haphazard growth and uncontrolled development, inviting speculation and unchecked migration that will likely be detrimental to Auroville.⁴⁴⁴ Equally a common mobility framework between these areas can address regional travel patterns that may invite congestion, traffic and pollution on the ECR and associated road networks. This was suggested by the Planning Group in 2006 and Gastebois in 2018.⁴⁴⁵ The PVAC Report notes:

Urban sprawl and haphazard development directly influence regional travel patterns and mobility networks. The region is characterized by limited sustainable transportation choices that provide connectivity between the urban centres, towns, and rural areas. Traffic congestion, lack of dedicated pedestrian/ bicycle facilities, safety, poor quality bus service, absence of a regional airport, and multiple port developments are some of the other major concerns related to efficient movement of people and goods.⁴⁴⁶

Fifth, regional food security to minimize imports: The rapidly changing land use from agriculture to urban settlements places pressure on the regional food security of the region –

⁴⁴³ Stein and Stein, 2013, 4, 6, 8.

⁴⁴⁴ Kalra et. al., 2012, 27-8.

⁴⁴⁵ Planning Group, 2006, 6; Arpi (ed.), 2018, 16.

⁴⁴⁶ Kalra et. al., 2012, 25.

A significant portion of area under cultivation in the region is rapidly being converted into non-agricultural uses. In Puducherry alone, it is predicted that in another two decades most of its territory will be urban with no agriculture left. Also, the productivity of the current agricultural land in the region is poor owing to unsustainable practices, lack of sufficient infrastructure and loss of agricultural labourers. The challenge is to protect the agricultural land base and to encourage its active use for food production.⁴⁴⁷

Villupuram and Cuddalore are primarily rural districts, with primary occupations being agriculture, cashew and casuarina plantation, fishing, along with the construction of four sugar mills and a number of modern rice mills in 2012. Predictions indicate that in two decades most of Puducherry's territory will transit to urban land use. In addition to Auroville's own food security planning in the Green Belt, a regional food security plan to support increase in organic agricultural yields to secure the villages' nutritional requirements and minimize imports from elsewhere is important. Particularly worrying is the fact that the 2008 Villupuram District Agricultural Plan does not reference Auroville ('nearness to state capital and Union Territory of Pondicherry, nearness to growth centers like Tiruchirapalli, Salem and Export promotion Zone are the major strengths of this district.')⁴⁴⁸ As the fourth largest and predominantly agrarian, fully electrified district in Tamil Nadu – with potential for paddy, cumbu, maize, groundnut, cotton, gingelly and sugarcane – regional agricultural policy integration with the Villupuram district is key to Auroville's food security and long-term sustainability.

Sixth, activating economic linkages and identifying relative spheres of specialization: A linked regional framework to develop economic activities across mutually-supporting specializations in each urban centre may allow for regulated labour migration and build common infrastructure at scale. Clustering benefits, key to economic security, are difficult for any centre to achieve on its own. Equally, this can allow for diversification and resilience in the commercial and industrial profile. As of 2012, Cuddalore's economy revolved around the activities of 30 industries in SIPCOT, an industrial estate on the outskirts of the town on the Cuddalore-Chidambaram road; Pondicherry is shifting from a largely agricultural profile to manufacturing industries, with a 200% increase in the number of industrial units from 1990-91 to 2005.⁴⁴⁹ The Confederation of Indian Industries' Puducherry Vision 2025, and a series of government initiatives to attract non-pollution industries, indicate movement for the future.⁴⁵⁰ It is in Auroville's economic interest to engage with Pondicherry and Cuddalore to generate a common economic action plan:

The region is large enough to contain a substantial mix of economic activities, yet small enough so that relatively few changes to the natural and economic landscapes can produce observable trends.

...

⁴⁴⁷ Kalra et. al., 2012, 25.

⁴⁴⁸ Villupuram District Agricultural Plan, 2008.

⁴⁴⁹ Kalra et. al., 2012, 50-1.

⁴⁵⁰ Confederation of Indian Industry, 2009; Industries, Investment Promotion and Commerce Department, of Tamil Nadu Electric Vehicles Policy 2023. G.O. (Ms). No. 41, 2023.

Building upon the principles of collaboration and cooperation as opposed to promoting competing interests and profit-driven decisions, the region will support an economic base that is based on the strengths of each community within the region. There will be high interdependence between the region's economic clusters such that the different activity centres – city, town, or village – complement each other. Intergovernmental coordination across political boundaries will be instrumental in marketing the region as a single entity to potential investors.⁴⁵¹

The region also has potential to strengthen its heritage and eco-tourism economy.⁴⁵² This requires a careful and common management plan to operate within the ecological carrying capacity and particularly in Auroville's case, to avoid unchecked promotion as a 'tourist destination', as is the case currently as stated policy of the Tamil Nadu State Planning Commission and Pondicherry 2036 Comprehensive Development Plan. This subject has been studied in the 2018 Tourism Impact Management Framework – this is beyond our scope here, but we note that Auroville requires urgent action in respect of the ten recommendations made in the framework to regulate its tourism framework.⁴⁵³ We suggest the development of experiential learning programmes as part of the tourism management framework in Part III.E below.

Seventh, cultural heritage and a regional identity: The region shares a common history and culture, with a diverse range of influences from the Pallava, Chola, Pandya and later Vijayanagara empires, before the French and English influence post-colonization.⁴⁵⁴ The cultural heritage of the region, under threat by several accounts, can be preserved through a regional collaboration.⁴⁵⁵ As Mother noted on 19th September, 1970, the 'Tamil culture, which is one of the oldest in the world, has a unique role to play in the city of Auroville ...'⁴⁵⁶ Today, with Auroville's cosmopolitan identity and aspiration, it can anchor a cultural integration of the region often overshadowed by development works.

Given these concerns, the PVAC Report suggests a series of proposals to generate a Sustainable Regional Planning Framework. A proposal to develop a 'regional integration plan' was, we may note, also referenced in Mother's early 1968 Ford Foundation letter, with subsequent proposals in the early years that prioritized an integrated development strategy.⁴⁵⁷ Records indicate a more inward-looking, 'defensive' approach since the 1990s, with the exception of the EAPP and BPP proposals in the 1999 draft Masterplan and some sporadic efforts since by Mr. Doshi in 2015 and the TDC in 2016.⁴⁵⁸ As far as we are aware, no serious engagement between Auroville and other centres has ensued since, with Auroville pursuing an independent approach to its own planning. The 2017 Town Development Council Terms of Reference

⁴⁵¹ Kalra et. al., 2012, 10, 97.

⁴⁵² Kalra et. al., 2012, 39, 53-7.

⁴⁵³ See, generally, Tourism Impact Management Framework For Auroville, 2019. A scoping study was made in 2019 for ten districts of Tamil Nadu to identify alternate rural tourism spots, but we are unaware if this was incorporated in policy planning. See, Auroville Foundation Annual Report, 2019-20, 38.

⁴⁵⁴ Kalra et. al., 2012, 43-4.

⁴⁵⁵ See, the Infrastructure Development Investment Program for Tourism by the Department of Tourism and Culture Government of Tamil Nadu, 2017, for a regional example.

⁴⁵⁶ Guigan, 2018, Vol. 2, 176-7.

⁴⁵⁷ See, for example, Hemsell, 1988.

⁴⁵⁸ Thomas and Thomas, 2013, 84-5.

highlight the need for regional planning in the bio-region defined as the five village panchayats in and around the plan area, but does not consider the question of a planning framework beyond.⁴⁵⁹ Indeed, the absence of any regional planning is clear as the only reference made to Auroville in the Comprehensive Development Plan for Puducherry Planning Area, 2036, approved in 2019, is in relation to tourism.⁴⁶⁰ Similarly, the 2017 Villupuram District Development Report prepared by the Tamil Nadu State Planning Commission only references Auroville in the following context: 'the District has good tourist attractions such as Rock cut temples at Mandagapattu and Thalavanur villages, Kabilan Kundru, Gingee fort, the cultural township of Auroville. The district with a good network of roads and rails can be developed as a major tourism centre.'⁴⁶¹

This lack of regional planning both places pressure on Auroville's ability to deal with common challenges (environmental conservation, watershed management, climate adaptation, tourism, mobility etc.) and under-leverages the benefits of symbiotic collaboration (economic diversification, limiting imports, regional food security, preservation of cultural heritage and cultural interchange to develop a positive regional identity). A regional planning framework is thus urgent for Auroville's security and equally, an exciting opportunity to develop models for regional integration that can serve emergent urban agglomerations elsewhere.

iv. Regional Planning Priorities

Based on our short review above, the following development priorities emerge:

1. Finalize the 'smaller' NTDA option.
2. Gain 'observer' status in the District Planning Committee / Regional Planning Authority. Liaison with the Local Planning Authorities of Cuddalore and Villupuram, for an MOU for priority tasks identified in the PVAC report and above; work towards a Regional Development Plan, with Puducherry, Cuddalore and Tindivanam, to pursue action points, along the lines of the PVAC Report, including a common agricultural strategy, identifying common environmental / water assets, economic synergies in agriculture, manufacturing and labour skilling, transport links and preservation of cultural heritage. To this end, the following studies in regional development will be necessary, including those identified in Revi, 2007:
 - a. Regional demographic and human development trends assessment, with demographic, and resource footprint simulation over the next one / two decades.
 - b. Regional natural resources (water, renewables, agriculture, forestry, biodiversity) with GIS development, partly identified in Stein and Stein, 2013 and the PVAC Report.
 - c. Regional housing and urban trend assessment.

⁴⁵⁹ TDC Terms of Reference, 2017, 2.4.

⁴⁶⁰ Puducherry Planning Authority, 2019, 15. See, Tourism Management Framework, 2019, 76 for recommendations to address this worrying trend.

⁴⁶¹ Tamil Nadu State Planning Commission, 2017, 126.

- d. Regional industrial, services and market development trend assessment, given the Tamil Nadu State National Commission Villupuram District Development Report, 2007 and the 2019 Pondicherry 2036 Vision.
 - e. Regional land market and real estate assessment.
 - f. Regional mobility assessment.
 - g. Regional energy assessment, with renewables manufacturing potential.
 - h. Regional hazard risk assessment, with a climate mitigation and adaptation strategy, in partnership with the Tamil Nadu Green Climate Company, in charge of the 2021 Tamil Nadu Climate Change Mission.⁴⁶²
 - i. Inventory of regional cultural resources and tourism management.
 - j. Coordination of family welfare and health services across the region including monitoring of state-led schemes, joint baseline health surveys and drafting/implementation of regional health plans.
3. Engage with the Tamil Nadu State Planning Commission for collaborative planning in Villupuram district, in relation to proposals for agri-oriented infrastructure (cold-storage plants, godowns, market yards and threshing floors), an agricultural special economic zone, extension centres for market intelligence, phone-based agricultural information delivery services, market infrastructure development and price surveillance, e-NAM utilization, organizing exposure visits to Auroville and other organic farms, full utilization of National Agricultural Development Programme funds, veterinary clinic and integrated organic dairy and livestock development and planned conversion of mud roads to bituminous roads for regional mobility planning to avoid increased traffic on access / highway roads to Auroville.
 4. Revive action-points outlined in the 2014 MOUs with village panchayats in the plan area, with a dedicated department / sub-group – the proposed Regional Planning Coordinator – within the Interface Team; define link / distribution of responsibilities / decision-making authority between Interface Group, Auroville Village Action Group, Village Development Councils and if adopted, the Outreach Board proposed below.
 5. Develop Village Development Plans under the MOUs / as proposed by the Land Protection Team in 2020 / Mr. Doshi in 2015 in defined time-targets; conduct a five-yearly socio-economic study of the bio-region, with demographic survey, population census, household and health surveys, inventory of key art, craft and cultural resources, appraisal of potential skill, economic and entrepreneurial development needs; accordingly identify priority social / physical infrastructure for the villages, with funding strategy for village development work, mapping of available resources through Central / State Government schemes and private funding, for a single-window bio-regional development fundraising.

⁴⁶² Environment, Climate Change and Forests Department, Government Order No. 101/2021.

6. Develop easy-access manuals for sustainable building techniques in Tamil to support culturally appropriate buildings and place pressure on construction incongruent with the region's long-term sustainability goals. Until an NTDA is functional, draft and suggest development guidelines to be adopted by the panchayats till an NTDA, with dedicated sustainable building support through the TDC Bio-Regional Coordinator / empaneled architects, as feasible.
7. Consider the feasibility of Bio-region Resources Centres, proposed below, to integrate all outreach development services; Develop a bio-regional communication strategy, with Tamil handbooks, explainers, pamphlets; develop communications strategy for school outreach, to allow local youth to explore Auroville with day programming.
8. Study the feasibility of vocational training centres for infrastructure development activity (construction, masonry, electrical work etc.) in the bio-region to develop favourable labour conditions locally.
9. Examine Walker's suggestion for forest extension northward on the Rayapudupakkam, Aprampet and Mathur watersheds and an extension of forest cover linking the Ashram lands adjacent to Ousteri Lake in collaboration with the Sri Aurobindo Ashram.⁴⁶³

v. *Review of Bioregional Outreach*

As we discussed in Part II, Mother's emphasis on collaborative development with the local population emphasized the need for (i) a relationship of equality, without a sense of superiority, with the villages, (ii) a preference against forced land acquisition, and (iii) a transitional Rurban environment to integrate the rural and urban geographies, a central concern in urban studies and planning today. Auroville's work on all three counts offers possibilities to establish a model to address ubiquitous concerns with urban planning across the globe. Over the years, Auroville has built a substantial outreach architecture, spanning health, education and employment. Our review here is short, to identify strategic planning priorities for the future to consolidate and strengthen the exemplary work done in the sector.

a. *The Outreach Landscape and Early Years*

Identifying the village communities as the 'first citizens of Auroville', Mother had emphasized the need to acknowledge the local rural population as the original and rightful inhabitants of the land on which Auroville was to be built.⁴⁶⁴ She had therefore stressed the need to respect, collaborate with and support village settlements in the process of developing Auroville, by building a community based on brotherhood and fraternity: 'A relationship that is not only cordial but friendly with the inhabitants of the neighbouring village is absolutely indispensable.

⁴⁶³ See, Auroville Today, October, 2019, 22. The evaluation of this proposal on technical grounds is beyond our competence, yet records indicate that this is an important measure to enhance regional water security.

⁴⁶⁴ Guigan, 2018, Vol. 2, 176.

For the realization of Auroville the first step is to establish a true human fraternity – any shortcoming in this regard is a grave mistake which can compromise the whole work.’⁴⁶⁵

What is known as the ‘bio-region’ today comprises largely of the Villupuram district of Tamil Nadu and its surrounding region bounded by the town of Tindivanam in the north-west and the Kaluvelly water tank to the north; with the union territory of Pondicherry (the region’s largest urban centre) and Cuddalore town to the south bordered by the Ustery tank, an important environmental resource in the region. There are a total of 40 villages in this wider region in the triangular stretch between Pondicherry, Tindivanam and Marakkanam and 13 villages in the immediate area of Auroville including Kuyilapalayam, Acharampattu and Oddampalayam. Besides these, six villages lie within the limits of the Auroville township: the settlements of Edayanchavadi, Irumbai, Kottakarai, Rayapudupakkam, Pettai and Alankuppam.⁴⁶⁶ Most of these villages are situated on the western side of the township where agriculture is intensive with the presence of large *eris* or traditional village tanks. Over the years, the process of city-building in Auroville has brought with it the question of whether to resettle and rehabilitate these six villages (within the township limits) to conform with Auroville’s urbanization or to work towards integrating them within Auroville’s emerging socio-economic fabric. As we noted in Part III.B, Auroville has proceeded in the spirit of the Mother’s vision for collaboration, rather than coercion, with a focus on strengthening bonds with local village communities through varied social, environmental and employment-generation work, rather than activating the land acquisition route.

‘Outreach’ work in neighboring villages had humble origins. In the early years, the lands purchased to develop Auroville were barren and infertile and its village settlements were categorized as one of the ‘most backward areas in need of development’.⁴⁶⁷ Yet, even before the formal inauguration in 1968, a symbiotic relationship between incoming Aurovilians and local villagers had begun to form with the new residents acclimatizing to the rhythms of local life:

As the first Aurovilians began to trickle in and settle down on the land, they learned about the rhythms and culture of the people around them in the villages, who were impoverished and mostly uneducated. Millions of saplings were planted simply as a measure of self-survival from the dust storms and the heat of the barren vast plateau.⁴⁶⁸

Reciprocally, local community knowledge was instrumental in undertaking the rejuvenation of the region’s native Tropical Dry Evergreen Forests and its water bodies. Similarly, the construction of the Matrimandir drew heavily on labour from local villages. In 1966, the Mother initiated outreach work, asking Aurovilians to ‘work in the villages’, beginning with education projects in Edayanchavadi and Morattandi.⁴⁶⁹ Records from the time illustrate the

⁴⁶⁵ Guigan, 2018, Vol. 1, 425.

⁴⁶⁶ Masterplan, 2001, paras. 1.3.1-4; Kalra et. al., 2012- 15-8.

⁴⁶⁷ Masterplan, 2001, para. 1.9.20.

⁴⁶⁸ Ciconesi and Ciconesi, 2012.

⁴⁶⁹ Thomas and Thomas, 2013, 77-8.

severe hardships encountered, with the first port of call being primary nutrition, health and public hygiene.⁴⁷⁰ The survival challenges of the time are recorded in an early account:

The life of villagers was so hard and so difficult (without money, water, food) – they were forced to stealing even basic necessities like food – their cows would graze and destroy our crops, our houses would be broken into – this was happening so frequently that making fences became a necessity to protect oneself, although the ideal of fencing and making divisions between communities and houses was not on our plans!

...

Villagers had one crop and if that succeeded they were lucky – their investment patterns depended on this – so that they also had to put their money aside and never spend it, as the risk was so high; also water had to be shared with the villagers – permanently people from the villages would come for water, taps would get broken, leading to empty water tanks and therefore no water for a week, for all; from the Dental Centre at Protection community, they would get water; if that tank was empty they would up Patrick for water – this went on for years, until finally the village panchayat got its own big overhead tank.⁴⁷¹

Thomas and Thomas' commentary sheds light on the evolving social dynamics of the time, relevant to place outreach works today in perspective:

Auroville sparked a variety of hopes for a better life in the minds of the villagers. Some sold their land to Auroville, responding to the call of the Mother to sell their lands, and bought better land elsewhere; some came to work in Auroville, mostly starting as manual labourers and household helpers; some did business with Auroville, providing building materials and work teams; many learned to speak English. Work relations with the local population were quite personal, and probably in the beginning surprising for the village people; it was not a relation based on castes or systems of exploitation, but rather they were considered as 'co-workers' in building Auroville.

The younger village population started being part of the new and young community; some of them benefited from educational training, adoption or support along with a social environment which nourished these children with elements of different cultures. Many children saw the friendly and struggling foreigners as a source of nourishment for their hunger for education and Aurovilians responded with schools for the children. The villagers worked hard and also learned new skills, a new language, and new ways to live.⁴⁷²

⁴⁷⁰ A range of early planning documents in the Archives paint a stark contrast between living conditions in the villages and the future city to come, with humble beginnings to feed, clothe and support the local population in its material needs. Thomas and Thomas, 2013, 77-8 quote Aggarwal, an early resident: 'The villagers were very impoverished, women had to carry water from three kilometres away, and children were unkempt ... the first need was the physical: cleanliness and nutrition ... [they] managed to provide milk powder and wheat to about 100 children and pregnant and nursing mothers ... selling rice at a fixed price ... There was around this time a programme to distribute food to children in the afternoon. The miserable condition of the children inspired Nata to open a Kindergarten which was inaugurated in late 1974. Children were medically examined, washed daily and given clean ironed clothes and adequate nourishment.'

⁴⁷¹ Thomas and Thomas, 2013, 108-9.

⁴⁷² Thomas and Thomas, 2013, 110.

What has come to be known as ‘outreach’ work in villages surrounding Auroville began organically as individually-led projects led by passionate Aurovilians and local village leaders looking for collaborative and symbiotic growth. Today, the outreach sector comprises over 50 community-oriented projects in Auroville’s bio-region, primarily in the areas of education, health, community development (women empowerment, sanitation) and conservation.⁴⁷³ Alongside, Auroville is also a seat of daily employment for villagers, with about 5,000 villagers employed in Auroville’s commercial and services sector.⁴⁷⁴ We briefly review the outreach architecture below.

b. Employment Generation

In response to the emerging fear of eviction and alienation among local communities in the early years of land purchase, the Mother approved an announcement that emphasized Auroville’s role as an employment generator for the villages.

... Because of Auroville, there will be better employment opportunities, the standard of living will improve and health, sanitation and educational activities will increase. Further, those who want to join Auroville completely will be taken as such. Auroville wants to give to each individual without any distinction of caste, community, religion or race, the opportunity to grow fully. Auroville is not merely a city but also a way of life ...⁴⁷⁵

As with the emerging pace of infrastructure development in the city-area, local villagers were employed in varying capacities largely in the primary and service sector, as manual labourers in farming and house-keeping. A minority undertook business activity within Auroville for the supply of building/construction material, while some worked managerial jobs in commercial units.⁴⁷⁶ The largely labour-intensive profile of Auroville’s economic units generated employment in the sector, yet with limited opportunities for vertical growth or skilling, placing pressure on wages.⁴⁷⁷ Managerial training and up-skilling in general has historically been low in Auroville’s commercial sector.⁴⁷⁸ By the mid-90s, significant growth in the bio-region was recorded, relative to neighbouring regions:

... contrary to most regions in India and certainly in the state of Tamil Nadu till the year 1996, there had been a significant growth in these hitherto ‘backward’ villages. While everywhere else – up until then – the normal trend had been a fall in rural population due to urban migration, a rising trend was found in the villages in Auroville’s immediate neighbourhood in terms of both employment creation and wages impact.

Every activity in Auroville arose from the primary needs to make the barren plateau habitable through reforestation and environmental regeneration, and then build the township, ranging from digging wells, constructing shelters, growing and preparing food collectively to setting up schools, medical centres, etc. In this process,

⁴⁷³ See, for a review of outreach activities, Auroville Bio-Regional Development Activities, 2020.

⁴⁷⁴ This figure is referred to in several places, but requires verification. See, Auroville Today, November 2019, 2 (‘... the figure of 5000 has been bandied about for years [since the survey in 2000], but nobody really knows.’)

⁴⁷⁵ Guigan, 2018, Vol. 2, 177.

⁴⁷⁶ See, Thomas and Thomas, 2013, 112-121 for a review. Baseline Survey, 2000.

⁴⁷⁷ See, Auroville Today, November 2019, 2.

⁴⁷⁸ Helen and Manjula, 2021 confirm this trend.

Auroville's development has been inextricably intertwined with more than 20 villages, which were once considered backward. From the very beginning, this has taken the form of providing a steady - even if modest - means of livelihood to a growing number of villagers for activities, which were mainly manual in nature.⁴⁷⁹

In 2000, a baseline survey was conducted to assess the impact and effectiveness of Auroville's growth on the local rural economy, document the demographic profile of Auroville's workforce drawn from neighboring villages and identify challenges.⁴⁸⁰ A net positive effect was found in comparison with neighbouring regions, confirming earlier surveys from 1987, but naturally with significant work yet to be done to raise living standards. While an up-to-date survey is needed today, to understand how matters have evolved in the last twenty years, our interviews anecdotally suggested that the findings from the survey conducted in 2000 are current in terms of structural concerns:

- i. 60% of the rural workforce in Auroville was seen to be coming primarily from 8 surrounding villages (within a 5 km. radius, with limited engagement with Pondicherry, Cuddalore, Tindivanam or the Villupuram district at large).
- ii. Auroville was evolving as a region with sound gender parity in the workforce with 53% being male and 47% being female. However, women were primarily employed as informal labour in housekeeping, babysitting and handicraft industries, outside the net of labour protections.
- iii. As is the employment risk elsewhere, a 'quick hire-and-fire' approach with no formal social security net was found, but with informal support generated through personal contact with residents. 51% of Auroville employees expressed that they 'do not like Auroville because of its job impermanency'.⁴⁸¹
- iv. In terms of income, it was found that 50% are not happy with the pay-scale but do not complain about it, 28% complain about their wages and only 19% expressed they are happy with it. The survey also noted that overall, the pay-scale is lower for women vis-à-vis men and relatively higher in the formal sector (paid through donations/grants) as compared to the informal jobs (which are paid mostly from the modest incomes of residents). Further, given that wages in Auroville are lesser than government pay and, in some years, minimum wages in shops and establishments as per Tamil Nadu labour law, villagers tend to prefer other opportunities if available.
- v. While benefits such as Provident Fund, gratuity etc. were available to locals working formal jobs in Auroville, the Small Employers Welfare Administration ('SEWA') Scheme was introduced in the 1990s as a security net for those working

⁴⁷⁹ Thomas and Thomas, 2013, 116-7.

⁴⁸⁰ Baseline Survey, 2000; Sampathkumar, 2006.

⁴⁸¹ Thomas and Thomas, 2013, 116.

in the informal sector.⁴⁸² Employees and employers who signed up for this scheme had to compulsorily save a part of the employee's monthly wages in a fund pool that would become available whenever they left their jobs. In the 2000s, SEWA had not been widely used because employees found it hard to set aside funds eating into their monthly wages. Equally, employers were disincentivized by the requirement of a 10% contribution over the monthly wages to enable a savings pool under SEWA, given the pressures emerging from the competitive market landscape Auroville had to navigate.⁴⁸³

Though data from recent years is scarce, the District Human Development Report, 2017 for Villupuram District suggests that a combination of positive developmental effects owing to Auroville and opportunities for migration to other urban centres post 2000 have led to a significant change in both the demographic profile and aspirations of the region.⁴⁸⁴ Thomas and Thomas identify this trend in the late 90s, which seems now to have intensified:

In addition, more and more local people started going out for work - especially men in the construction sector - while their only source of employment until 2000 was within Auroville. During the last decade, these skilled workers (skills acquired from their years of experience in Auroville) went even for non-permanent contract work onto 'greener pastures' such as Pondicherry, Chennai and Bangalore, where the faster growth pace due to global trends demands skilled personnel in various types of construction activities.

The subsequent generation of workers' children has now also started going for higher education. Even if this means a lot of investment through taking loans, the villagers realise that their children need a good education to be upwardly mobile in India. This means that young educated persons from the village may also leave the bioregion for employment elsewhere as certified nurses, teachers, engineers, etc. This will eventually trigger a considerable emigration by the next generation from their villages. As a result, the trend in the 1990s of immigration of villagers into the Auroville bioregion, due to regular availability of work inside Auroville, may no longer be the case.

Already now, certain types of workers like earth workers i.e. those who dig the soil for making trenches, foundations ... are no longer available in the immediate area, as this generation has aged and subsequent generations have moved away from this work.⁴⁸⁵

A number of units are also engaged in rural employment generation, aside from commercial units and households that employ local villagers. The Integral Rural Development and Sustainable Enterprises Development in Auroville Bio-Region ('SEDAB'), which ran from 2012-2016, aimed to create sustainable and innovative rural enterprises in two blocks of the Villupuram District in the Auroville bio-region with financial support from Central and Tamil

⁴⁸² Auroville Foundation Annual Report, 2010-2011, 118; Auroville Foundation Annual Report, 2011-2012, 27.

⁴⁸³ See, Thomas and Thomas, 2013, 118-9 for details on the SEWA Scheme. See, Auroville Foundation Annual Report, 2020-21, 31-2 for current details on the scheme, which includes a retirement fund service scheme (295 individuals), insurance service (98 domestic workers), provision for interest-free educational loans (funded by Stichting De Zaaier, but numbers / amounts unavailable), and awareness programmes.

⁴⁸⁴ Tamil Nadu State Planning Commission, 2017.

⁴⁸⁵ Thomas and Thomas, 2013, 120.

Nadu Governments. In the final year, they targeted the poorest families in 47 villages of 32 panchayats in the blocks of Vanur and Marakkanam, with community managed enterprises (22 enterprises with 487 rural women) continuing to function and develop. The SEDAB project supported these initiatives through two Common Facility Centres and marketing assistance in collaboration with Auroville units.⁴⁸⁶ The AIAT conducts industry-linked training in electronics, hardware, mechanical goods, construction, finances and IT-TES, with a high employment rate.⁴⁸⁷ The Wellpaper initiative supports social enterprise development, with eco-Handicraft skilling, organized ‘within independent profit-sharing groups earning income according to quality of performance and group progress.’⁴⁸⁸ Alongside, Unlimited Tamil Nadu and the Social Entrepreneurship Association hosted by the Auroville Campus Initiative, developed by the Tamil Nadu State Rural Livelihood Mission, attempted a start-up incubator for social impact entrepreneurship,⁴⁸⁹ and enterprises like Lively Boutique, for the sale of handicrafts and clothes produced by small village enterprises, have worked to develop market linkages for products made by rural women.⁴⁹⁰ To augment these works, vocational education programmes in tailoring, sales, computer skills, handicrafts and permaculture have been instituted, albeit with a variable distribution and emphasis, across the surrounding villages, particularly for rural youth, women and at-risk sections of the community, by the Life Education Centre, Lively Boutique, Auroville Industrial School, Bamboo Centre, and the Sustainable Livelihoods Institute.

A thorough evaluation is beyond our scope; yet, as we discuss below, evidence-led planning and strategic interventions for the next stage of employment generation and economic development of the region is necessary to respond to this changing dynamic. Absent investment, the natural processes of migration of youth, and structural unemployment or low-wage work, present a serious concern for Auroville’s aspirations for integrated development. Sampathkumar’s 2006 study, ‘Areas of Strategic Planning for the Work Force’ provides a blueprint for this work.⁴⁹¹

c. Health Interventions

As land regeneration gathered speed in the late 70s, the focus shifted to social development in the bio-region. A key aspect at this stage was healthcare, especially for populations in the villages in the plan area and the immediate vicinity. The Auroville Health Centre (‘AVHC’) was founded in 1969 as a dispensary approved by Mother for the village of Kuyilapalayam, with a permanent built structure in 1973 with an emphasis on primary health care, i.e., preventive care including immunization, maternal and child nutrition, public health and health education.⁴⁹² Rural women were trained as Village Health Workers to conduct home-based

⁴⁸⁶ Auroville Foundation Annual Report, 2016-17, 27.

⁴⁸⁷ Auroville Bio-Regional Development Activities, 2020, 7.

⁴⁸⁸ Auroville Bio-Regional Development Activities, 2020, 34.

⁴⁸⁹ Auroville Foundation Annual Report, 2020-21, 22-3; Auroville Foundation Annual Report, 2018-19, 44-5, Auroville Foundation Annual Report, 2016-17, 28-9.

⁴⁹⁰ Auroville Foundation Annual Report, 2017-18, 34-5.

⁴⁹¹ Sampathkumar, 2006.

⁴⁹² Thomas and Thomas, 2013, 112-3.

medical check-ups and door-to-door awareness campaigns on community-centric health parameters such as level of hygiene, sanitation, nutrition and immunization.

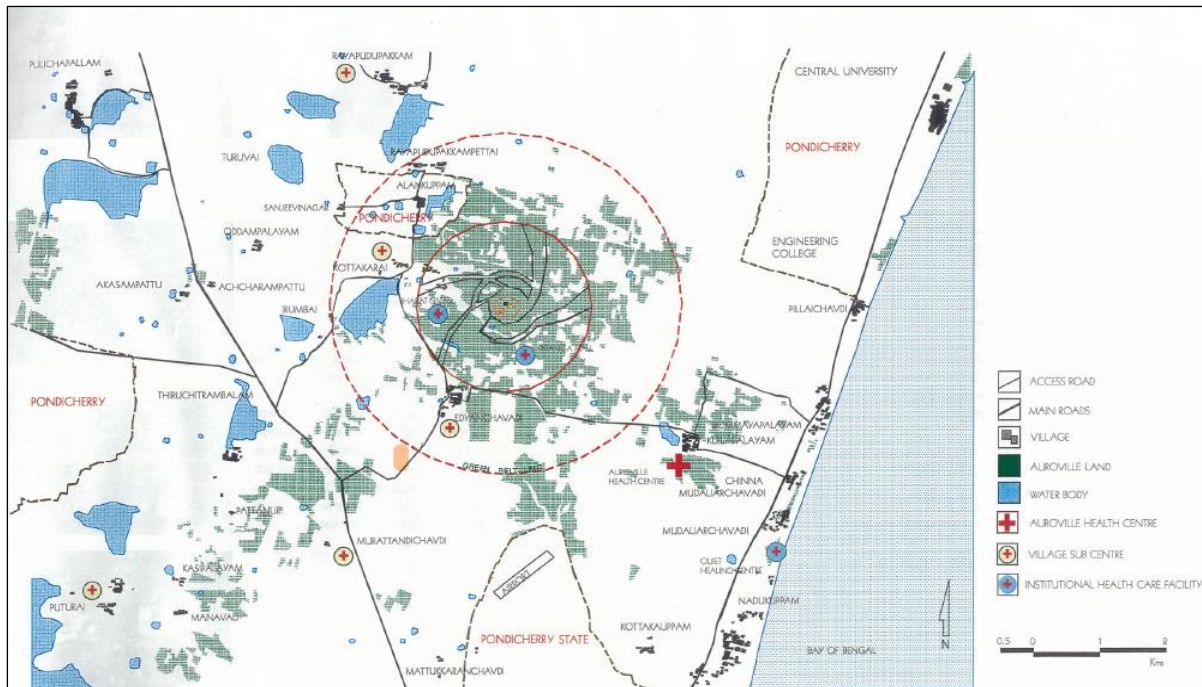

(Recognized healthcare facilities in the bio-region, 1999. *Source:* Residents’ Assembly Masterplan, 1999, 45)

Gradually, the AVHC grew to include six sub-centres in different villages surrounding Auroville, along with a laboratory for basic diagnosis and a pharmacy, mainly run by local villagers. It was recognized as a Mini-Health Centre by the Tamil Nadu State Government and in 2014, the Aravind Eye Hospital opened a vision centre. The AVHC today covers about 20,000 rural community members in Auroville’s bio-region from adults to adolescents and school children.⁴⁹³ Along with the AVHC, affordable and accessible dental care also began to be offered in Auroville’s surrounding villages by Aurovilians. The Auroville Dental Centre Education Research Rural Action (‘ADCERRA’) was set up in 1982 with the aim to fill the gap in dental care, spread awareness on oral hygiene and mitigate the taboos associated with dental treatments.⁴⁹⁴ Rural women were trained as dental workers, working from 10 sub-centres along with a headquarters. A range of other projects – natural health care education and addiction programs at Thamarai

Besides these institutional interventions towards better health care in the bio-region, social enterprises were also founded by far-sighted Aurovilians that combined public health care and awareness with women’s economic empowerment and environmental conservation.⁴⁹⁵ One

⁴⁹³ Auroville Bio-Regional Development Activities, 2020, 6; Auroville Foundation Annual Report, 2021-21, 27.

⁴⁹⁴ Auroville Bio-Regional Development Activities, 2020, 4; Auroville Foundation Annual Report, 2021-21, 28-9.

⁴⁹⁵ See, Auroville Bio-Regional Development Activities, 2020 for details on units involved in women empowerment: the Annual Women’s Solidarity Festival, 8; Life Education Centre, 14; Palmyra, for women’s self-help groups, 17; Small Steps, 33; Wellpaper, 34.

notable example in this domain was Eco Femme, set up in 2010, which mobilized local rural women and young adolescents for work in menstrual education and hygiene, involving them in the production and distribution of cloth pads/sanitary napkins.⁴⁹⁶ As of January 2018, Eco Femme was reported to have sold approximately 300,000 pads, while over 15,000 rural women and girls have been reached in terms of menstrual health education and hygiene, and in 2019-20, as an example, it distributed 52,100, 15,219 and 10,376 free, subsidized and cost-price sanitary pads across the country.

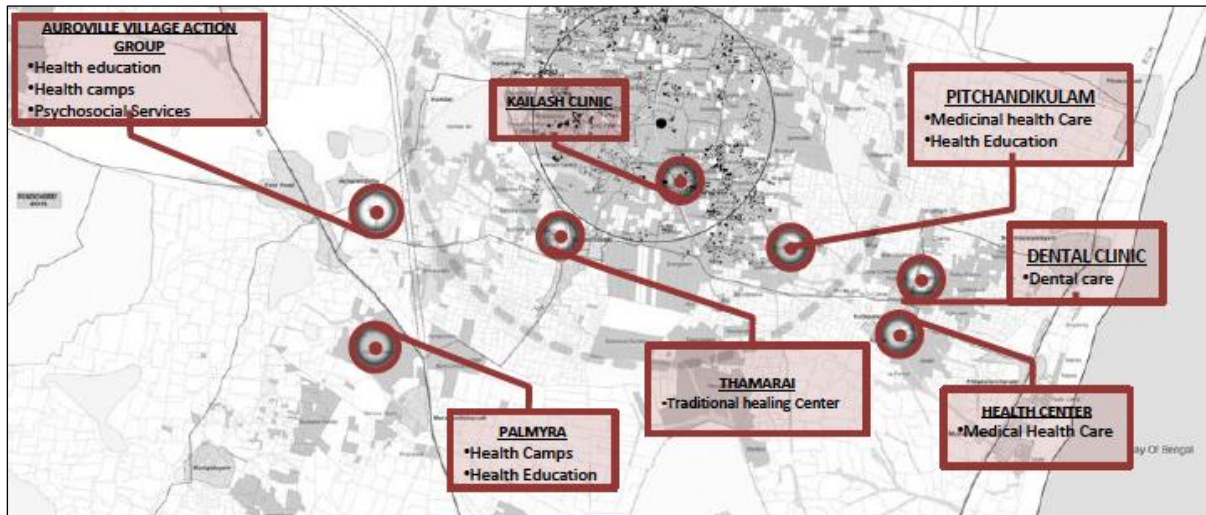

(Top, health interventions in the bio-region. Source: TDC, Annual Development Plan, 2014-15, 61)

d. Outreach Schools and Skill Centres

One of the earliest interventions came in the form of formal and informal schooling for rural children. Naturally, the attractions for villagers in the early years to the idea of Auroville came through the educational benefits their children could access by learning amidst a relatively more affluent and literate international community. In 1966, the Mother directed three committed Aurovilians (Varadharajan, Syamala and Nata, whose work stands out for its dedication) to work in the villages of Edayanchavadi and Morattandi. These efforts led to establishment of the Arulvazhi School and Education Centre in 1982, which focused on providing education on the lines of the free progress system as best adapted to the circumstances in the villages to children between the ages of 3-18 years.⁴⁹⁷ Similarly, since the 1980s, other schools were set-up in the villages surrounding Auroville, which came to be known as ‘Outreach Schools’ – Aikiyam School (1987), Isaiamabalam School (1982), Illaignarkal Education Centre, Tamil Ulagam Evening School, Thamarai, Udhayam Educational and Cultural Centre, Life Education Centre (1991), Deepam (1992), Udavi School (1998) and New Era Secondary School (2007).

⁴⁹⁶ Auroville Bio-Regional Development Activities, 2020, 9; Auroville Foundation Annual Report, 2019-20, 39-40.

⁴⁹⁷ See, Aggarwal, 2011.

These schools varied in terms of scale, the profile of student populations catered to and the philosophy of educational outcomes, yet they were all bound together by the drive to nurture curiosity and holistic personality development in the spirit of introducing progressive education to the bio-region.⁴⁹⁸ For instance, the New Era Secondary School combines free progress methodology focused on personality growth with the priority considerations in the bio-region to secure employment post-graduation, with a ‘modified’ CBSE curriculum. The Life Education Centre caters especially to young rural women interested in building vocational skills from tailoring, embroidery to handicrafts and teaching.⁴⁹⁹ STEM Land, the Auroville Institute of Applied Technology and the allied C3STREAM initiative – remarkable, first-of-their-kind institutions in the region – provide vocational and applied technology training through progressive pedagogical methods, with a 100 percent placement rate for students, alongside the recent introduction of an innovative Bachelor of Vocation with Pondicherry University.⁵⁰⁰ Illaignarkal similarly provides an ‘anytime schooling’ facility for Auroville workers and their wards, with a focus on skilling, particularly for low-income and at-risk families, acting alongside as a social mentoring hub. Alongside, its *Auroville Seydhi Madal*, a Tamil language monthly, stands out for its concerted efforts to build a dialogue of trust and cultural exchange. Udavi school equally stands out for its notable efforts to transition from an examination-centric model of learning to the free progress system, in patient conversation with parental push-back and cultural attitudes attendant to this difficult exercise in a rural / semi-rural setting.⁵⁰¹ A detailed review of the outreach schooling sector is beyond our scope, yet we may note that the work of each of the six Outreach Schools and allied centres is a shining example of the dedication, goodwill and collaborative ethic Mother envisioned for work in the bio-region. In terms of skills training, workshops by the Auroville Earth Institute, self-help groups setup by the Auroville Village Action Group, after school service and digital literacy projects at Thamarai, vocational training at the Life Education Centre, Bamboo Centre and Solar Village projects supplement educational efforts.

e. *Environment and Integrated Community Development*

Environmental work and rural upliftment go hand in hand in integrated development schemes, the scheme also in Auroville from the early days. The Auroville Village Action Group (‘AVAG’) was set up in 1982 as a nodal agency to promote and coordinate all environmental and community development activities in the 40 villages surrounding Auroville.⁵⁰² It works through a network of 340 village self-help groups (‘SHGs’) with over 6,000 women and men in 85 settlements and 35 Panchayat villages. This includes the Paalam Bridge Youth Network that runs six-month leadership and sustainable development training programs for 18 villages in the bio-region.⁵⁰³ A range of other outreach activities take the form of social enterprises kickstarted by Aurovilians at the intersection of environmental conservation, women’s

⁴⁹⁸ See, essays in Sri Aurobindo Institute of International Education Research, 2018 for a review.

⁴⁹⁹ Auroville Bio-Regional Development Activities, 2020, 14; Auroville Foundation Annual Report, 2011-12, 25.

⁵⁰⁰ Auroville Foundation Annual Report, 2019-20, 34-5; 58th Meeting of the Governing Board, Auroville Foundation, 2022, 5.

⁵⁰¹ Agarwal, 2020.

⁵⁰² Auroville Bio-Regional Development Activities, 2020, 8;

⁵⁰³ Auroville Foundation Annual Report, 2015-16, 19.

empowerment and community development or not-for-profits providing consultancy services on afforestation, water conservation and waste management. Social enterprises such as Waste Less and Eco Pro attempt to promote a culture of environmental sensitivity through the promotion of sustainable daily-use items.⁵⁰⁴ Simultaneously, platforms like the Pitchandikulam Bio-resource Centre, Auroville Botanical Gardens, Palmyra Institute of Ecological Land Use and Sadhana Forest focus on environmental education centered around spreading knowledge about the varied uses of the natural Tropical Dry Evergreen Forests, with campaigns of afforestation in collaboration with the local youth.⁵⁰⁵

The institution of SHGs in particular – in tailoring, handicrafts and beauty services – is a key component of the outreach architecture, given robust evidence linking women empowerment and developmental indices.⁵⁰⁶ In 2007, all SHGs under the Village Action Group were organized under the Udhayam Women’s Centre, expanding work to skill development, credit linkages and regular workshops/trainings on savings, loan repayment, insurance coverage, business development through collaboration with NABARD and the Tamil Nadu Rural Livelihoods Mission. Subsequently, AVAG also organized men into various SHGs. As of 2012-13, with figures broadly in that range today, about 4,700 women and men were organized under about 250 SHGs.⁵⁰⁷ As of 2016-17, the total savings of all SHGs has been Rs. 6.1 crores and a credit uptake of Rs. 9.8 crores with 100% repayment rate.⁵⁰⁸ SHGs have also been supported by the Palmyra Rural Women’s Self-Help Group Federation, through a range of efforts: these include support to access government schemes for sanitation, health, hygiene, agricultural support, and facilitated borrowing from the Pallavan Rural Bank and the Pallavan Grama Bank, for the erection of bore wells, laying of pipelines, purchase of agriculture land, construction of houses, children’s higher education, crop cultivation, small business, purchase farming machineries, etc.⁵⁰⁹

In addition to SHGs, the creation of new rural enterprises has also been encouraged through linkages with various government programmes, primarily those run by Tamil Nadu Corporation for Development of Women. Under SEDAB, community managed enterprises were developed and sustained in the Vanur and Marakkanam blocks, with Kamalam, a sales outlet established by the Auroville Visitor Centre, to promote ethical and eco-friendly products made by rural entrepreneurs.⁵¹⁰ Equally of note are community development projects undertaken by Auroville Water Harvest, Auroville Health Services, Palmyra Centre, Botanical

⁵⁰⁴ See, Auroville Foundation Annual Report, 2020-21, 21-2, for a review of Waste Less’ work, including the Garbology Lite pilot programme and Know Plastics. Notably, they wrote the state curriculum for Tamil Nadu for recycling etc.

⁵⁰⁵ See, Auroville Foundation Annual Report, 2019-20, 18-20; Auroville Foundation Annual Report, 2020-21, 22. The extension, consultancy and training work of these units, Pitchandikulam in particular which works in 25 villages through the Kaluvelli bio-region, is significant.

⁵⁰⁶ Kumar et. al., 2021.

⁵⁰⁷ We were unable to locate statistics as of May, 2023.

⁵⁰⁸ Auroville Foundation Annual Report, 2016-17, 25-6.

⁵⁰⁹ Auroville Foundation Annual Report, 2014-15, 22.

⁵¹⁰ Auroville Bio-Regional Development Activities, 2020, 27. This notable intervention was closed in 2016, and may be revisited.

Garden, Pitchandikulam, Sadhana Forest, Auroville Earth Institute and Thamarai.⁵¹¹ These projects include the setting up of village cultural centres, organization of village cultural festivals, development of the Harmony Village Promenade (Sanjeevinagar) in 2011, Chai Hut in Morattandi and Pattanur villages in 2018, after school and youth workshops, training, capacity building and awareness programmes, amongst others.

Notably, given the persistence of caste and gender dynamics in the region, integration programmes through exchanges between varied SHGs are also undertaken, though ethnographic work will be required to understand (what is often) a slow process of evolution on these social indices. An integrated approach to rural development, in general, is apparent – though not coordinated as such – in varied initiatives such as for the promotion of sustainable agriculture through farmer awareness drives and workshops in the optimal use of water and organic fertilizers, water re-generation works through construction of ponds and canals, setting up of water treatment plants and drinking water facilities across villages, awareness drives to improve solid waste management systems and community health development through a focus on health education programmes, medical camps, de-addiction sessions, leprosy sensitization and geriatric care. To sum up, the following maps outline the outreach architecture in Auroville.

⁵¹¹ The extension and training work, including school and youth related work, is exceptional. For a summary, *see*, Auroville Bio-Regional Development Activities, 2020. For details, *see*, Auroville Foundation Annual Report, 2017-18, 33-4.

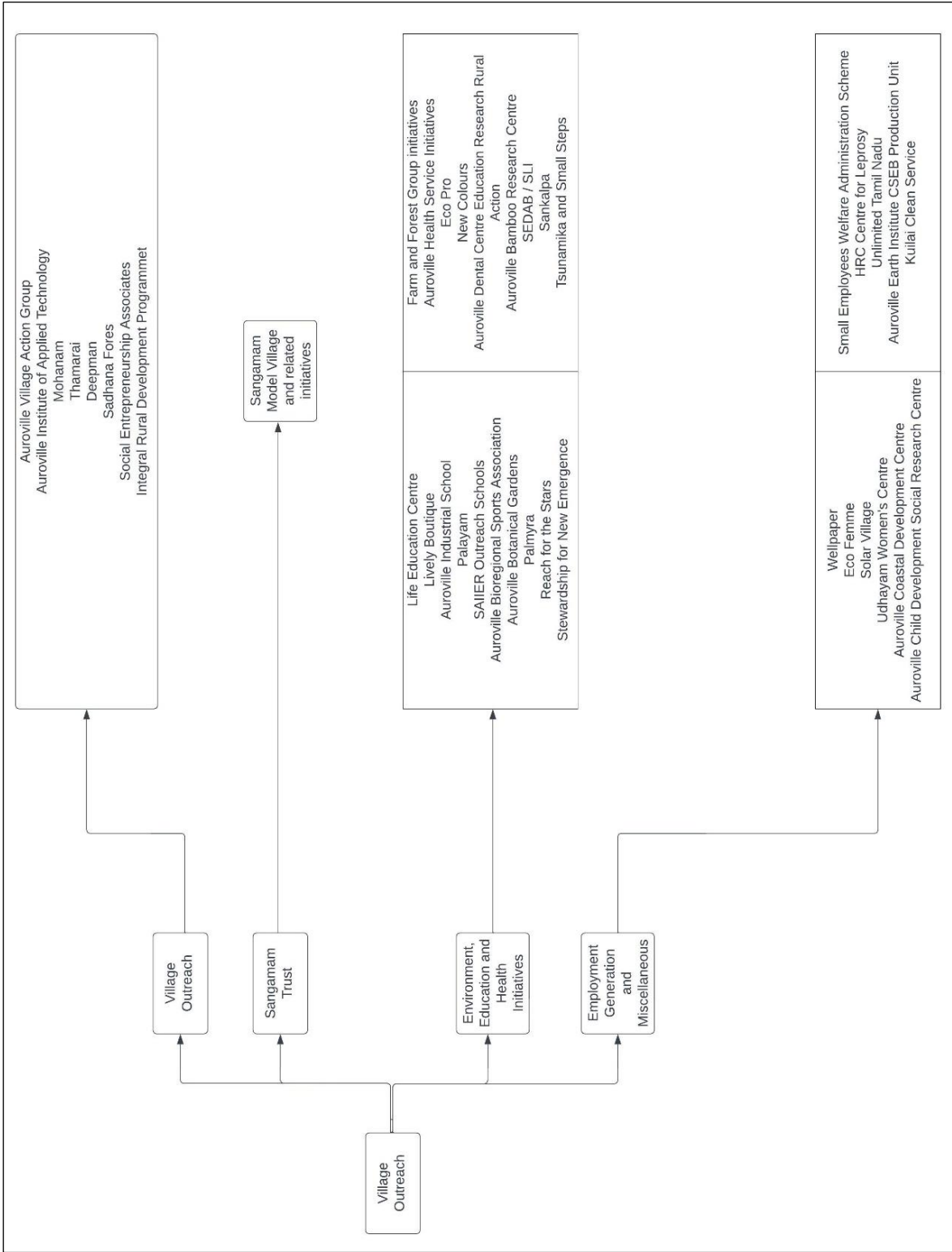

(Auroville units involved in bioregional outreach)

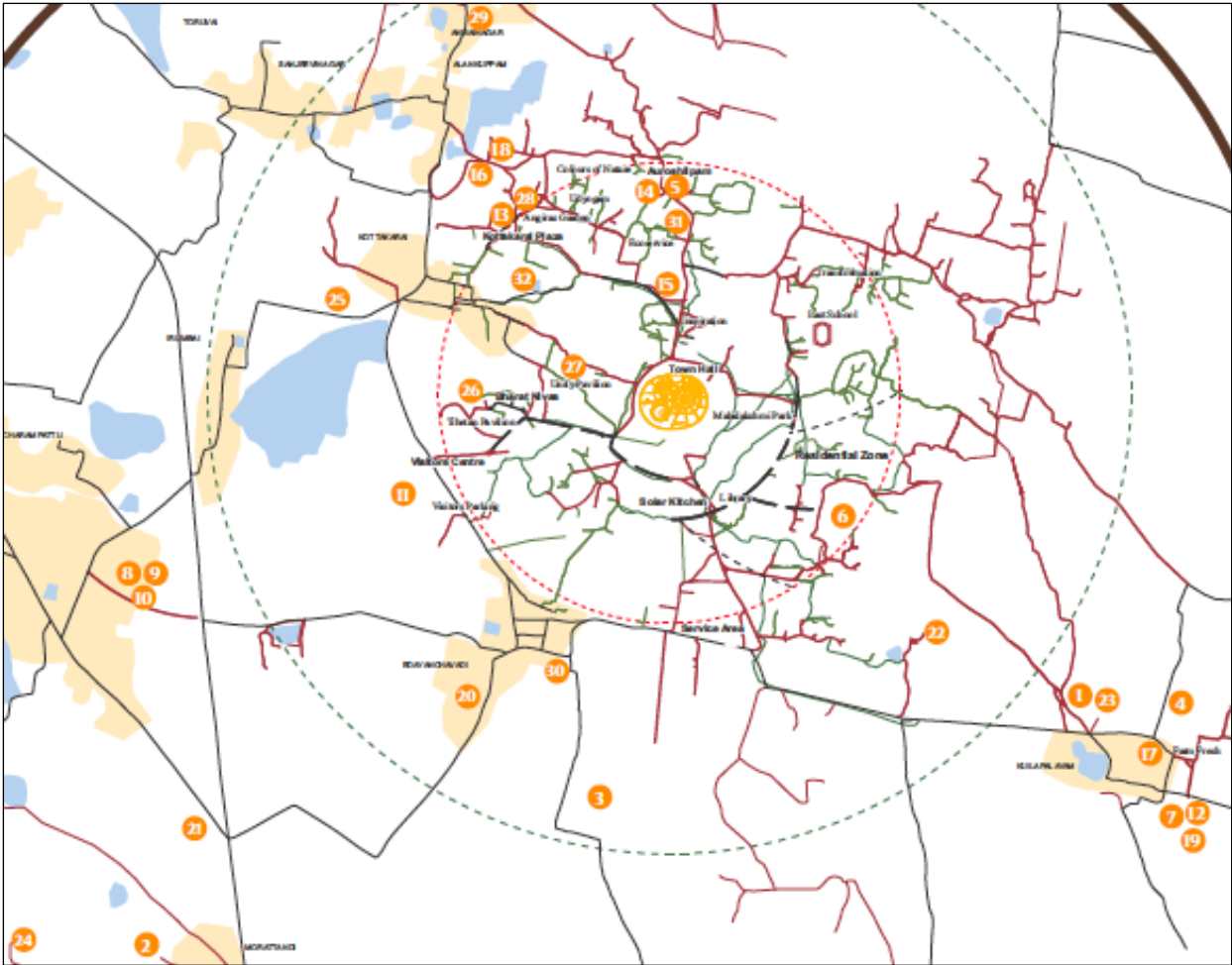

- | | |
|---|---|
| 1 Aikiyam School | 18 Life Education Centre |
| 2 Arulvazhi Education Center | 19 NESS |
| 3 Auroville Botanical Gardens | 20 New Colors |
| 4 Auroville Dental Centre Research Rural Action (ADCERRA) | 21 Palmyra-Auroville |
| 5 Auroville Earth Institute | 22 Pitchandikulam |
| 6 Auroville Film Festival Educational Outreach Program | 23 Reach for the stars - Stephanie |
| 7 Auroville Health centre | 24 Sadhana Forest |
| 8 Auroville Institute of Applied Technology-ITI | 25 SLI |
| 9 Auroville Village Action Group | 26 Sankalpa: Art Journeys |
| 10 Bio-regional Sports and Culture Association | 27 Stewardship workshop |
| 11 Compressed Stabilized Earth Block production unit (CSEB) TDC | 28 Solar Village (auroville consulting) |
| 12 Deepam, Children with special needs | 29 Thamarai |
| 13 Eco Femme | 30 Udavi School |
| 14 EcoPro | 31 Smallstep and Tsunami |
| 15 Ilaignargal Education Centre | 32 Wellpaper |
| 16 Isalambalam School | |
| 17 Kullai Clean Service | |

(Placement of units involved in regional outreach. *Source:* Auroville Bioregional Development, 2020)

vi. *Challenges and Development Priorities*

As such, the concerted efforts of Aurovillians over the years have generated a notable outreach architecture. Auroville has indeed come a long way from the early years, with subsistence concerns predominant across the region and the uncertainties of social integration baked into the meeting of two vastly different worlds and aspirations. Emerging, as it did, organically in response to individual calling and the felt needs of the region, outreach works may today benefit from consolidation and systematic planning, with evidence-led interventions to expand and strengthen existing initiatives. Some structural concerns remain tied to the broader socio-economic dynamics of the region, particularly in employment generation, gender and caste disparities and ecological security, which will require strategic interventions to develop *in situ* capacity in the medium-to-long term. Having undertaken the hard work, we suggest now some strategic interventions that Auroville may explore to leverage and build the momentum of past efforts.

a. *Outreach / Bio-regional Development Plan*

A Bio-regional Development Plan, along with an Outreach Strategy Plan, is necessary, both to consolidate existing outreach works and to allow for a systematic expansion to effectively address local needs and aspirations at scale and in lock-step with Auroville's own development to avoid a widening gulf of inequality. Existing interventions have made a mark, yet the development of the bio-region has a long way to go, with economic sustenance and poverty concerns, significant environmental and agricultural challenges, social dynamics of caste, gender discrimination and others. The current outreach and bio-regional planning and policy architecture is weak – with the exception of the AVAG's Village Development Councils – with individual initiative driving discrete projects. In 2018, for example, Auroville Today reported that 'while many Auroville groups are working on outreach in the bioregion ... there was no consistency in how they communicate ... and sometimes contradictory messages are sent'.⁵¹²

The scale of the challenge will require a systematic and planned approach – with strategic interventions for defined short, medium and long-term goals – to secure the interests of the bio-region and those of Auroville, whilst allowing for greater daily interchange to secure the cultural integration of communities. This approach is required along all three tracks, for socio-economic development, natural resource management and physical infrastructure planning, which will require systems for internal coordination. Alongside, the documentation of existing work with data collection practices going forward, as we suggest below, can allow for the significant funding potential for bio-regional development to be leveraged from state and central government resources and the private sector. There are considerable opportunities, both within Tamil Nadu and outside, yet to be explored, for which robust documentation and a planned strategy are necessary. Calls for integrated planning have been made since the 1980s, in the 1999 Residents' Assembly Masterplan, Mr. Doshi and the TDC in 2015, the 2014 MOUs and the plot level detailing suggested by the Land Protection Team in 2020 – a streamlined institutional architecture is needed to anchor this work and translate long-standing proposals

⁵¹² Auroville Today, January, 2018, 342. *See*, Evangelista et. al., 2018.

into action plans. Our proposal for a dedicated, single-window Outreach Board below is geared to that end.

b. Strengthening Village Development Councils and Integrated Bio-region Resources Centres

There stands a need to formalize Auroville's connections and communications with its villages through structured management and coordination systems. Formalizing and regularizing the meetings of the Village Development Council with the *ex officio* inclusion of the TDC Regional Coordinator, translation of the 2017 MOUs into action plans, leading to Village Development Plans, and identification of voluntary conflict resolution or grievance redressal mechanisms for and other disputes through a commonly constituted body by the panchayat and AVAG / Outreach Board. The AVAG's substantial work in this direction provides a pathway to strengthen inter-sectoral linkages, a concern voiced in interviews. Further, given the dispersed placement of outreach units in the bio-region (*see*, visual depiction above), a clustering of future enterprises will be helpful for common investment and to generate spatial cohesion and collaboration – this could take the form of an interlaced network of Integrated Bio-region Resource Centres in strategic locations in each village cluster, for common offering of educational, health, commercial and cultural facilities.

c. Data Collection and Outreach Dashboard

The development of a bio-region integral data management system will be helpful, with (i) socio-economic census / survey, including an employment survey for employees in Auroville units and homes, measuring demographic changes, levels of access to credit etc. (ii) epidemiological surveys to design healthcare interventions, (iii) future projections for the bio-region to anticipate growth profiles and (iv) impact evaluation of existing projects for documentation of existing work and evidence-led review of interventions. The Auroville Outreach Development Database, prepared by the Working Committee and the Town Development Council in 2014, may be used as the template for this work.

To augment data collection and translate it into real-time policy action, an outreach governance dashboard with integrated data management solutions may prove useful. These could be along the lines of the geolocation and infrastructure mapping of *anganwadi* centres using Kobo Collect by the Department of Women and Child Development, Government of Maharashtra. Such a system would visualize basic village information (location, population, demographic profile, nutritional profile etc.), existing community development programs, communities covered and so on to aid in periodic review and monitoring of activities. A structured approach along the lines suggested above in managing outreach activities is necessary to identify needs and demands and gaps in coverage (geographically and thematically) for designing planned and targeted interventions, and in undertaking periodic reviews of existing programs to incorporate data-driven feedback.

d. Local Skill Development and Economic Growth

As we discuss in Part III.F, Auroville's current commercial profile has generated significant local employment, yet opportunities for up-skilling, promotion and increased wage are limited

owing to the labour-intensive profile. Livelihood concerns continue to persist and, in some cases, have intensified.⁵¹³ Expanding to manufacturing and MSME sectors can generate substantial employment for the bio-region. Alongside, a concerted effort will be required to conceptualize, plan and execute a village-level economic plan in consultation with the panchayats and local authorities.⁵¹⁴ This is a challenging medium to long term task, yet socio-economic data collection and planned interventions will be critical for long-term sustainability of the region to check speculative activity, unsustainable urbanization patterns, uneven migration flows and social tensions arising out of an unequal development between Auroville and its neighbouring regions. Early planning documents, indeed till the 80s, exhibited an emphasis on integral development with the bio-region – that orientation needs to be revived as the bio-region is, in the words of the 1999 Residents’ Assembly Masterplan, ‘a part of the Auroville experiment.’⁵¹⁵ This requires a concerted effort for data collection, planning and liaison with panchayats, local and state administration, including the Tamil Nadu State Planning Commission. There is significant potential in the region for skilling, technical and managerial education, meso-credit extensions for local enterprise etc., but urgent action is necessary as Auroville cannot afford unplanned economic expansion in the already changing demographic profile of the region. SEDAB, closed in 2016, was a notable intervention in this direction, and may be revisited. We propose an independent, expert-led body to anchor this task in Part III.F.

e. Scaling, Impact Assessment and Evidence-Led Interventions

In assessing current works and planning for the future, Auroville may consider leveraging recent innovations in evidence-led social interventions, particularly in relation to scaling up its current activities. Collaboration with / learning from the work of J-Pal in this sector may be considered to allow for at-scale, low-cost impact. In particular, the following interventions may be considered in the Auroville context: TaRL,⁵¹⁶ school leadership and management training,⁵¹⁷ work by Pratham, healthcare interventions between the Government of Tamil Nadu and J-Pal,⁵¹⁸ ‘multi-faceted graduation programs’ for sustainable livelihoods,⁵¹⁹ microcredit schemes (run currently by Palymra and AVAG),⁵²⁰ integration of the MAVIM e-business platform for SHGs in Maharashtra and strategic interventions to provide market intelligence in agriculture.⁵²¹

⁵¹³ Villupuram Development Report, 2017, 126; Auroville Today, No. 36, 2019.

⁵¹⁴ See, Sampathkumar, 2006; Villupuram Development Report, 2017.

⁵¹⁵ Residents Assembly Masterplan, 1999, 61-2.

⁵¹⁶ JPAL, 2022b.

⁵¹⁷ Jpal, ‘Impact of School Leadership Training on Management Practices and Student Learning in India’, n.d. The successful interventions of the Principal Leadership Development Program in New Delhi by CreatNet may also be explored as a template. See, Creatnet Education, ‘Leadership Development in Public Education Systems’, n.d.

⁵¹⁸ JPAL, 2022a.

⁵¹⁹ Banerjee et. al., 2015.

⁵²⁰ JPAL 2023a. The Villupuram Development Report, 2017, 126 notes that the district ‘is blessed with a network of credit and non-credit cooperative institutions with a membership of 3.52 lakh.’ Leveraging existing credit institutions can be explored.

⁵²¹ JPAL, 2023b; Bharti, 2020. The 2008 Villupuram District Agricultural Plan lists this as a priority action point, with budget outlays. See, Villupuram District Agricultural Plan, 2008, 67.

f. Impact Funding

Outreach works in Auroville rely largely on foreign and CSR donations, followed by the City Services Fund (58 lakhs and 84 lakhs respectively in 2020-21 and 2021-22). Orienting itself to impact assessment – through a robust data collection system and evidence-led interventions – will allow outreach activities access to considerable resources available for impact funding, currently under-leveraged in the sector. These include ESG donations through CSR, Impact Investors Council, World Bank Development Research Programme, Tata Trusts, Gates Foundation, Omidyar Network, Asha Impact, Ashoka Changemakers, Aavishkar, ABC Impact, Acumen, Ally Venture Capital, Artha Impact, Beyond Capital, FMO, Dell Foundation, Lemelson Foundation, Ashva Capital, Avaana, SDI bond market etc.) Alongside, funding opportunities under the Tamil Nadu Innovation Initiatives / State Innovation Fund may be explored.⁵²² State and central government development scheme funding options are also substantial, and under-leveraged in the outreach sector currently. A coordinated resource mobilization effort amongst all units – coordinated by the Outreach Board – will be necessary to maximize potential.

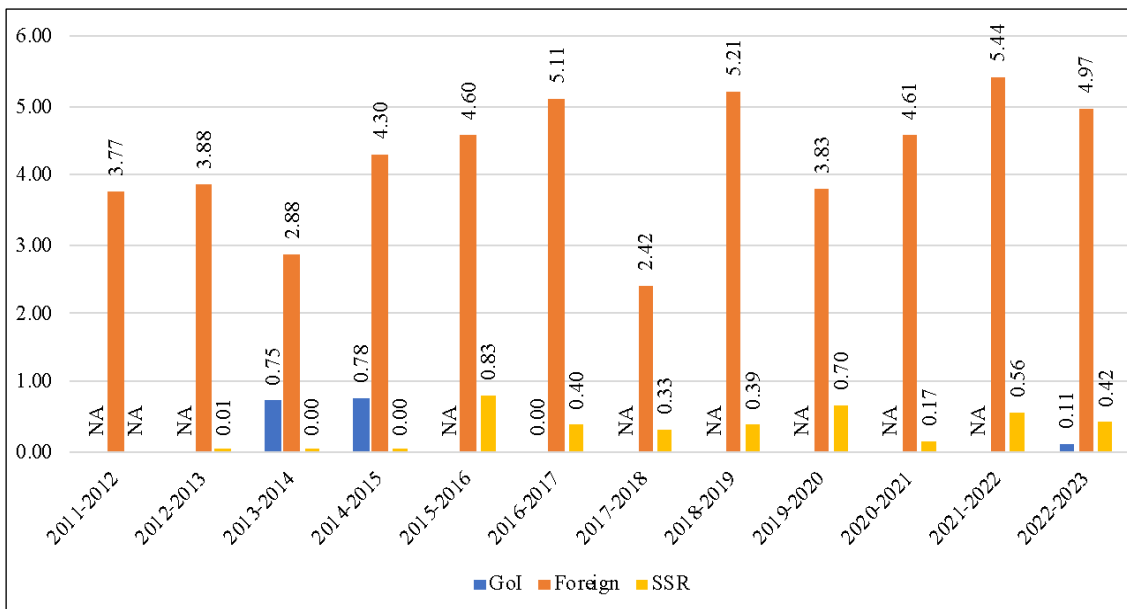

(Village outreach grants and donations, 2011-23)

g. Research Translation

Documenting and translating outreach work into published research is an under-explored area in Auroville, with some notable exceptions in Illaignarkal, STEM Land and Udavi. This can both serve as a reflective anchor to review and strengthen outreach work, as also generate a meaningful conversation and positive footprint externally. While pedagogical research relating to the substantial work in outreach education may be anchored in the research frame of SAIER on the lines suggested in Part III.E, for interventions in environment and conservation, health, women empowerment, employment and economic development and cultural works, a dedicated documentation and research wing under the Outreach Board suggested below will

⁵²² See, Planning, Development and Special Initiatives Department, 2023.

be valuable to assist units to translate action into research, in popular magazines and peer-reviewed research journals alike, with yearly seminars / conferences (a ‘Rural Development Conclave’) to promote knowledge exchange and sharing amongst practitioners across the country and globally. Alongside, the Outreach Board may consider instituting Auroville Outreach Fellowships (in collaboration with Ashoka Changemakers, Teach for India, Azim Premji Foundation, IRMA and other aligned organizations) in fields of rural education, participatory rural development, health, conservation, women empowerment etc. to invite young practitioners aligned to Auroville’s ideal as part of an assisted newcomer process.

h. Outreach Board

Currently, outreach works are conducted by a range of Working Groups and individual residents leading units / projects – as we note in Part IV, a sensitive rationalization follows the early stage organicity that was necessary in the circumstances in which most enterprises began to allow for a systematic and cohesive plan of action. Both for units to collaborate and to anchor future growth, a nodal body will be helpful. To anchor the diverse activities in the bio-region and in anticipation of growth, the mandate and capacity of the AVAG will need substantial strengthening, both in terms of funding and human resources. Given their existing work profile, however, Auroville may consider establishing an independent Outreach Board as a single-window anchor for coordination and action under the Outreach Strategy Plan and Bio-Regional Development Plan.⁵²³ For the latter, which concerns planning operations in the bio-region, effective coordination with the TDC Regional Interface anchor will be necessary, who may be an *ex officio* member of the Board.

To conclude, we may note that as ties between Auroville and the bio-region deepen, cultural, economic and racial tensions may naturally be expected as part of the process. The notable outreach architecture discussed above, particular in schooling and social enterprises, that serves to ensure daily, living exchanges between Auroville and the bio-region is critical to develop a cultural bond.⁵²⁴ This may be augmented with programmed youth visits to Auroville, films on Auroville history, values and activities, social theater, an outreach newsletter (with expanded distribution of the *Auroville Seydhi Madal*) etc. to generate greater awareness and people-to-people contact. The work of Mohanam is notable in this regard and may serve as an anchor for future strengthening. The ‘Cultural Heritage Festival’ conducted in 2004, and ‘Village Heritage Festival’, may be annualized as a platform for regular exchange and celebration. The natural trajectory of growth, without interventions, risks a gulf between the two worlds. In the long-term, the depth of cultural interchange in micro-environments will dictate the success of Auroville’s Rurban experiment. This is naturally easier said than done, yet we may reiterate its importance: our proposal for a dedicated Outreach Board is to anchor this substantial responsibility.

*

⁵²³ Placing additional burden on the AVAG’s considerable works may not be a feasible option. *See*, Auroville Foundation Annual Report, 2014-15, 19-20 for its comprehensive work profile.

⁵²⁴ *See*, Auroville Foundation Annual Report, 2014-15, 20; 2016-17, 27.

D. HOUSING

Auroville's urban form was envisioned as a rich ground for experimentation in housing, to manifest 'the architecture of the future.'⁵²⁵ High densities in the Residential Zone – 281 persons per hectare in the 1967 draft Masterplan, 400 in Anger's proposal accepted by Mother, 358 in the 2003 Directions for Growth Report and 300 in the Land Suitability and Land Use Proposal – presented among other things an architectural challenge for Auroville to solve, as a 'model city': to design dense yet uncrowded living spaces that engender communal warmth and intimacy yet offer space and solitude. Envisioned as a place brimming with energy and diversity, reflective of the cosmopolitan make-up of its society, the cultural architecture of neighbourhoods was to embody the ideal of unity in diversity, with community facilities and public spaces (sports complexes, libraries, groceries, stores, common kitchens, parks and so on) all envisioned in the early years. In the ideal, Auroville is to map out a new urban archetype, responding to the cultural and physical ills attendant to urbanization globally, of overcrowding and hygiene, on one hand and sprawl and alienation, on the other.

i. Early Vision, 1965-1980s

a. Values Guiding the Residential Zone

In his first report to the Mother in 1965, 'On Planning Auroville', Anger underscored the societal and spiritual values that should drive the development of housing in Auroville, on which the Mother provided her highlights and comments:

Architecture and research aspiring to the highest ideals of beauty and perfection should drive the construction of housing in Auroville. 'The trend of Auroville's architecture will be directed towards an architecture of the future, such has to be the main research. It indeed appears indispensable that by the very aim and reach of Auroville, she should be given a new face deriving from research and an impetus towards beauty.'⁵²⁶

Mother in turn commented on the importance of balance in manifesting the idea of beauty:

Beauty in simplicity – comfortable but without luxury for luxury, harmony in usefulness. Nothing is more beautiful than a harmonious simplicity.⁵²⁷

Anger further noted the need for diversity in housing development, to avoid monotony:

... the best solution in any case, consists in finding a wide range of types of accommodations, that is to envisage a mixture of individual, and small apartment blocks as well as buildings interconnected in series with patios, terraces, etc. Only such a mixture will allow a play of volumes that will not be monotonous.⁵²⁸

And Mother reiterated the need for a housing mix:

⁵²⁵ Anger, 1965.

⁵²⁶ Anger, 1965, 4.

⁵²⁷ Guigan, 2018, Vol. 1, 123.

⁵²⁸ Anger, 1965, 8.

I am in favour of some diversity in the types [of accommodations], in accordance with the types of residents.⁵²⁹

Anger further emphasized the social dynamics of housing development in his proposal to 'redensify' Auroville: to nurture a close-knit, community living and avoid, as cities tend to become, alienating islands of scattered living:

Should also be avoided the trap of a city cold because it feels like a desert due of excessive separation. It is indeed essential very important not to create a city that would be too scattered. What one has to reflect on and succeed in dealing with it is the difficult problem of urban grouping and thus avoid falling into the trap of 'dormitory-towns', of known new towns and of large American 'individual' housings areas.⁵³⁰

Here the Mother underlined the phrase 'avoid falling into the trap', marked the last two sentences and commented: 'Very important'. And finally, Anger pointed to the need for communal warmth and solitude, for communities to be close yet independent, an architectural challenge of some proportions at the density and scale of the Residential Zone:

The manner in which the homes will be treated plays an essential role in the image of Auroville ... It is therefore necessary to re-discover urban warmth by creating contacts as permanent as possible between residents, while still making it possible for them to withdraw completely.⁵³¹

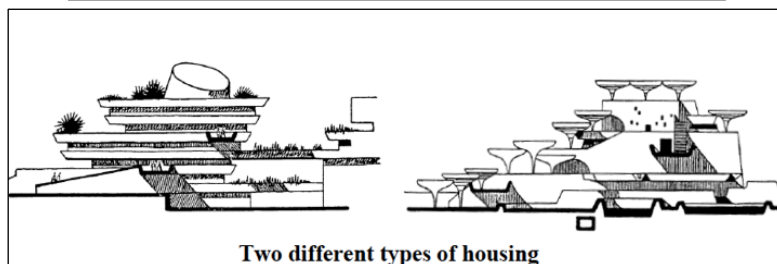
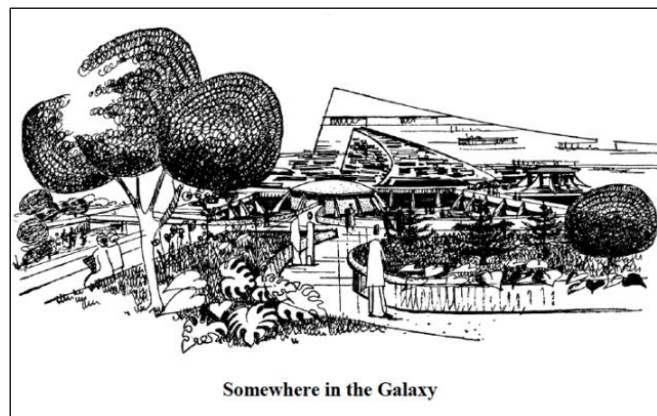

(Early visions of diverse housing structures nestled in a neighbourhood in the Galaxy. Source: Anger, 1968)

⁵²⁹ Anger, 1965, 8.

⁵³⁰ Anger, 1965, 9-10. The reference to the alienation of American towns brings to mind Edward Hopper's paintings, which capture well Anger's sentiment here. Whitney Museum, 2001.

⁵³¹ Anger, 1965, 10.

In practical terms, as we noted in Part II, Anger's density proposal of September 1965, which Mother approved, envisaged approximately 40000 inhabitants per sq. km. and 7500 accommodations per sq. km (i.e., 75 houses per hectare), with the average house plot size at 300 square meters, in the Residential Zone.⁵³² With the sense of urgency and ambition at the time, Anger had imagined 10,000, 20,000 and 50,000 inhabitants in 5, 15 and 20 years respectively.⁵³³ As Guigan notes, there is some discrepancy in Anger's calculations, which pushes the density figure higher. Guigan however calculates the density with 50 houses per hectare. An average figure would be 75 including both collective and individual housing.⁵³⁴ He also assumes that Anger's calculations do not exclude the area for roads and common spaces, which is not clear from the proposal itself. Guigan also references the allotment of larger housing plots by Mother, which is not unsurprising as she preferred a diversity and space in the early days was available. In any case, Anger's proposal gives average figures – these are approximate calculations and the difference is relatively minor.

This early exchange points to the Residential Zone as aspiring to a dense, rich and communal arrangement of life, representing the full play of architectural and cultural diversity within a calm and unifying wideness, an embodiment of *maheshwari*:

Tranquil is she and wonderful, great and calm for ever. Nothing can move her because all wisdom is in her; nothing is hidden from her that she chooses to know; she comprehends all things and all beings and their nature and what moves them and the law of the world and its times and how all was and is and must be ... Equal, patient and unalterable in her will she deals with men according to their nature and with things and happenings according to their Force and the truth that is in them. Partiality she has none, but she follows the decrees of the Supreme and some she raises up and some she casts down or puts away from her into the darkness ... In each man she answers and handles the different elements of his nature according to their need and their urge and the return they call for, puts on them the required pressure or leaves them to their cherished liberty to prosper in the ways of the Ignorance or to perish.⁵³⁵

A truly international living: 'the tower of Babel in reverse'.⁵³⁶ Looking back at this exchange, and Anger's exquisite 1968 description in '1', one's imagination cannot but be inspired with possibility. Coming on the back of urbanization and housing crises at the time, of the ideological movement towards functionalism of the 1970s, and in anticipation of future trends in India, the Residential Zone was an attempt to turn the tide:

[On densities] ... meaning you have to live together: One has to learn to live together as one will not always have enough land to build a house kilometres away from one's nearest neighbour, and certainly not in Auroville. It is the business of Aurovilians to have the right attitude that is part of the work that we all have to do ... One has to take an inventive step, an urbanistic one ... include contemporary life, human

⁵³² Guigan, 2018, Vol. 1, 122, fns 1, 4.

⁵³³ Guigan, 2018, Vol. 1, 123.

⁵³⁴ We have calculated the averages assuming an equal spread of individual and collective housing, and only for the Residential Zone (which may decrease depending on residential facilities in other Zones).

⁵³⁵ Sri Aurobindo, CWSA, 1997, Vol. 32, 25-7.

⁵³⁶ Guigan, 2018, Vol. 1, 173.

relationships, technology and respect for nature, within a very creative context to show to the world that *it is possible*.⁵³⁷

Interestingly, in a short exchange, in March 1973, when Shyam Sunder reported to Mother the difficulty in purchasing land for Auroville owing to land ceiling restrictions, Mother responded with a (humorous) ‘can we have a garden with each house?’ insisting as in other areas for high ambitions for Auroville despite constraints.⁵³⁸ Mother had earlier, in 1968, imagined the Residential Zone in the following terms, part of the early curve of the planning process:

Maheshwari: South – Residential zone

The shape will be Hexagon. The colour will be gold, golden pink. The shape signifies ‘Perfect Creation’. The Residential zone will have 3 sections. 1) People who wish to stay in a collectivity, that is to say as neighbours, can stay there. 2) There will be old men’s and women’s houses. Also big houses like management houses where people can have all the facilities, because they work outside in various places. All these houses will be surrounded by gardens and trees. 3) There will be independent houses with gardens and trees.⁵³⁹

b. Spatial Vision

These initial reflections on the style and values to guide housing development – ‘a perfect creation’ – were further elaborated in terms of spatial specifications in the Detailed Galaxy Plan prepared by Anger in 1969. By this time, the population target of 50,000 had been set, with a broad identification of the land parcels that would house the Residential Zone. Anger’s proposal contemplated the following:

First, majority of the population would be housed in the Residential Zone (43,000) and the remaining student/researcher population would be distributed across the Cultural Zone (5,000 in the proposed University campus) and International Zone (2,000). Second, the Residential Zone would be organized into neighbourhoods and wards, through the creation of five zones/sectors (A-E) in order to ensure an optimal distribution of densities and housing typologies. Third, three housing types were proposed – Vertical Collective and Horizontal Collective Housing (individual units with shared common spaces and facilities, typically housing higher densities) concentrated in Zones A, B and C and Horizontal Clustered Housing (‘family housing (with) a family of 4 persons occupying each house on an average’) distributed across Zone D (with vertical housing) and Zone E.⁵⁴⁰ Fourth, heights of housing units and densities of populations would decrease from Zone A to Zone E and increase as one moved outward from the Matrimandir towards the peripheries of the city area. That is, the highest storied buildings (collective housing, ground +3 stories) would be found on the peripheries of the city. Zone A would house the highest densities of population and Zone E the lowest densities.⁵⁴¹ A year earlier, speaking of the macrostructure, Anger described the imagination in broad terms as follows:

⁵³⁷ Aware Auroville, 2023 (emphasis ours).

⁵³⁸ Guigan, 2018, Vol. 1, 109.

⁵³⁹ Guigan, 2018, Vol. 1, 245.

⁵⁴⁰ Anger, 1965, 5.

⁵⁴¹ Anger, 1965, 8.

We first come to a zone of gardens and of private single-story houses. It is a rather flat area, with widely diversified foliage, where houses are integrated into the terrain, by both color and building materials. Earth-colored reddish tarmac lanes contribute to this cohesion. They meander up to the main ways. As one goes deeper into this huge garden where pools scatter sunlight, one sees slightly higher houses, mostly two-storied, giving a striking impression of variety: no house is similar to another. Though their shapes are very audacious, they all retain a common look of simplicity, of tranquility. They open widely on very private patios. As we move forward, building materials and colors begin to shift according to a strange gradation, like a subtle rainbow weaving its own bridge of light and colors through the town.

... [moving to the higher-rises, the] vertical axis contains systems of high speed elevators and escalators offering quick circulation with and between the levels and easy communication to residential sectors. Such a pyramid constitutes a complete organic unit for ten to fifteen thousand inhabitants. When several are positioned on the ground, interconnected by causeways, a growth pattern is established which could finally contain half a million people. Each unit enjoys naturally its own life and relations with others.⁵⁴²

Fifth, indispensable to the housing development distributed across the Residential, Cultural and International Zones was the ‘service ring’ or Crown envisaged as ‘the main ring of the town, which was to join and feed the main service area of the zones and wards.’⁵⁴³ The Crown would thus act as the downtown of the city – the ‘vital soul’ – providing basic community services, transport pathways and public spaces for recreation. In doing so, it would take on a specific function according to each zone, for e.g., in the Residential Zone:

It will be the main ‘Street’ of Auroville where one can get perishable as well as exceptional food stuffs. Where one can find entertainment, restaurants, coffee-houses, bars, permanent information (library, newspapers, bookstalls, sauna. A very important place will be given to handicrafts and to all kinds of exhibitions. Co-operative stores could provide to Aurovilians all that they want (prefabricated elements for housing...)⁵⁴⁴

...

In the residential zone these streets, with all their meeting places, will become arteries for creative neighborhoods (not dormitories) of people enjoying some particular common activity that will be their distinctive mark, a source for unique offerings to others. In the central ring, other meeting places will be found to accommodate several such groups.⁵⁴⁵

⁵⁴² Anger, ‘=1’, 1968.

⁵⁴³ Anger, 1965, 10.

⁵⁴⁴ Anger, 1965, 11.

⁵⁴⁵ Anger, ‘=1’, 1968.

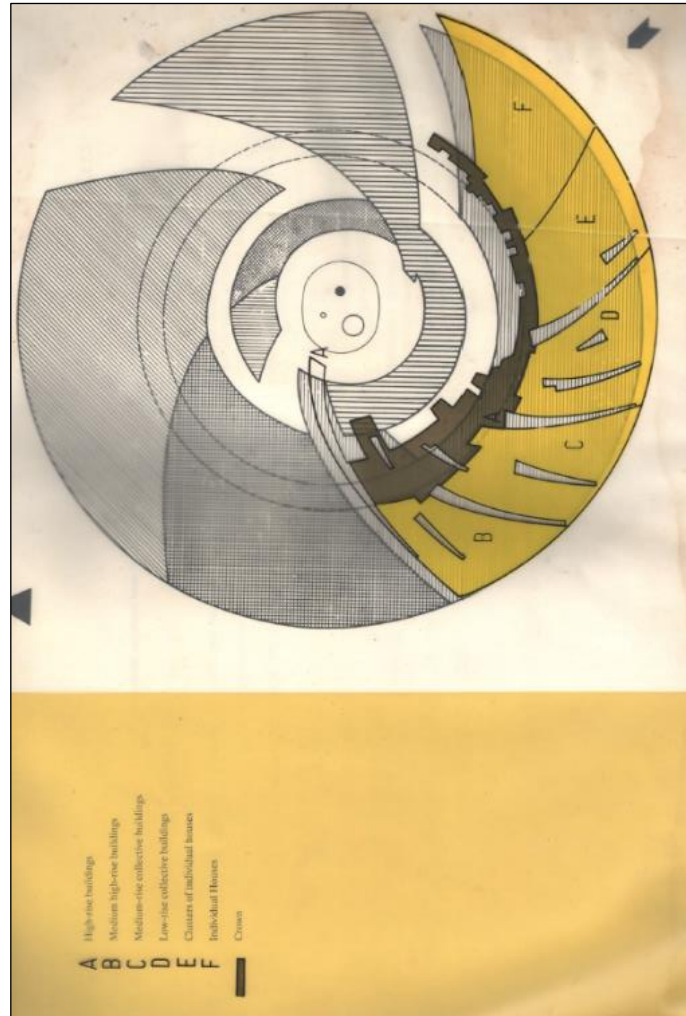

— Capacity of absorption :

(0)	(1)	(2)	(3)	(4)	(5)	(6)	(7)	(8)	(9)
1	42,000	9	0.65	245,700	3,685 1,092	4,422 4,368	4,422 2,184	2,184	8,700
2	8,000	9	0.65	46,800	702 208	842 832	842 416	416	1,674
3	5,500	8	0.65	28,600	429 127	515 498	515 249	249	1,013
4	21,000	8	0.65	109,200	1,638 485	1,965 970	1,965 970	970	3,905
5	5,500	8	0.65	28,600	429 127	515 249	515 249	249	1,013
6	13,000	8	0.65	67,600	1,014 300	1,217 1,200	1,217 600	600	2,417
7	20,000	7	0.65	91,000	1,368 404	1,638 808	1,638 808	808	3,254
8	14,000	7	0.65	63,700	955 283	1,146 1,132	1,146 566	566	2,278
9	3,000	5	0.65	9,750	146 43	175 172	175 86	86	347
10	21,000	4	0.65	54,600	819 243	983 972	983 486	486	1,955
11	5,427	4	0.65	14,110	211 63	257 232	257 127	127	509
								20,415	27,145

i. e. approximately 27,100 inhabitants (20 400 grown-ups and 6,700 under 20 years of age)

(0) = No of the building
 (1) = Surface covered on the ground in m²
 (2) = Average number of levels.
 (3) = Coefficient of utilisation
 (4) = Useful surface
 (5) = Number of cells and flats
 (6) = Number of inhabitants according to type of housing
 (7) = Number of grown-ups
 (8) = Number of children
 (9) = Total number of inhabitants.

(Left, vision for the Residential Zone organized into sectors (A-E) in 1969. Right, population distributions and built-up area 'absorption capacity'. Source: Auroville Development Scheme, 1988-1995; Anger 1969, 11)

This early vision, its design specifications apart – to redensify the urban, yet ‘give an extraordinary contact with nature’, develop organic, living residential contact so that ‘a kind of open fraternity can exist’, to utilize technical advances and push for innovative aesthetic forms – was *avante garde*, anticipating the turn of future movements:

Compact cities have, since the early 1990s, been one of the leading global paradigms of sustainable urbanism ... the compact city harnesses the advantages of agglomeration and taps into the tremendous variety of environmental, economic, and social benefits it has to offer through proper planning and development.⁵⁴⁶

Managing densities – the anchor on which Anger’s early work revolves in many ways – is the deep and difficult problem to be solved in the Residential Zone, as the most concentrated of the four zones in Auroville. The issue naturally lies in design and planning details, beyond our scope, yet the nature of the challenge may be articulated:

The debate over the compact city as a set of planning and development strategies is actually between the ‘decentrists’ who are in favor of a decentralised form and the ‘centrists’ who are in favor of a high–densely built form. Breheny discusses in more detail the view on the future of urban form in regard to decentrists, centrists, and compromisers. Based on the literature, the main critical arguments of the compact city are advanced by the decentrists who question the environmental benefits delivered by compactness strategies. They claim that the anticipated energy reduction is modest compared to the discomfort inflicted by compactness policies as necessary rigorous measures. They believe that it is impossible to halt the urban decentralization phenomenon that is suited to the majority of the population, which favors the tranquillity of rural and semi–rural areas. In short, the key reason for the heated debate revolves around GHG emissions, energy consumption, and the loss of open green areas in light of the escalating urbanization trend. A key point against the compact city model regards the loss of green spaces in urban areas and the inevitable development of green fields outwards due to high congestion and high density.⁵⁴⁷

c. Early Development Challenges

The Detailed Galaxy Plan thus crystallized the vision for housing in Auroville by giving it a spatial structure. The distribution of densities and housing typologies across the five neighbourhoods along with a service ring providing community facilities and public spaces presented a vignette into how the built form could nurture community. As we discussed in Part III.A, the realities on the ground in the 1970s however were far from ideal – with chronic financial concerns and the immediate task of regeneration at hand, not to add the lack of human resources, meant that often, as Doctor-Pingel notes, pioneering work was done within severe constraints:

There were no qualified structural engineers, contractors or supervisors, and skilled masons, carpenters, painters or bar-benders, were almost non-existent. Building materials available in Pondicherry, 10 km away, were rudimentary and the next big possibility was Chennai, 160 km away. Despite these difficulties and limitations, the buildings that came up in those early years still manage to inspire many: be it Roger’s

⁵⁴⁶ Bibri et. al., 2020, 1.

⁵⁴⁷ Bibri et. al., 2020, 5.

buildings with their curvilinear earth-hugging innovative shapes, the ‘Aspiration’ huts of Piero and Gloria using local know-how in a modern way or Popo’s low-cost ‘Fraternity’ workshops inspired by Japanese simplicity and detailing. Today in Auroville we take for granted the workmanship of different roofing and flooring possibilities; the quality of rammed earth, exposed brickwork or precast concrete; the ability of the local untrained but enterprising supervisors and contractors to read and understand drawings, as well as their willingness to experiment, to take on new challenges and learn from their mistakes. Masons and carpenters are proud of what they do in Auroville. A building construction crew with ‘Auroville experience’ commands respect and welcome in megapolises like Bangalore, Chennai or Hyderabad. Changes of this kind in a society do not come in a day and require the persistent effort of many years.⁵⁴⁸

It is indeed incredible to imagine early efforts to build housing – individual housing using vernacular building material – thatch, palm, *keet*, earth, the famous ‘capsules’ – began to be built wherever land was able to be acquired, with approximately twenty loosely organized communities across the terrain. The *terra nullius*, as it were, was slowly settled. These individual houses ranged from temporary to even permanent structures such as what was known as ‘Auroson’s Home’ (now Certitude) or the Auromodèle and Aspiration settlements, now outside the plan area.⁵⁴⁹ With the Galaxy as the future ideal, yet undefined, communities developed organically, with piece-meal development, outside of a planning framework, an understandable and perhaps necessary dynamic at the time that continues till today, with calls for a more cohesive and systematic approach. Ryckaert paints a picture of the development of housing and communities:

The first phase from the inauguration of Auroville in 1968 till the late 1970s saw mainly the construction of experimental huts and simple shelters by the early pioneers. Aspiration, Auroville’s largest settlement at that time and still existing today, showcased the possibility of simple homes made of mud walls, wood panels and thatched roofs. However, already then several residences built with steel and cement dotted the Auroville landscape.⁵⁵⁰

One aspect to note here is that since development in the pioneering phase (1970s-late1990s) unfolded in response to wherever land was able to be acquired, most housing units came to lie outside of the city area or outside the Residential Zone once the city limits were designated. As of 2014, ‘approximately 25% of the Aurovilians live ‘outside’ the city area.’⁵⁵¹ Attempts at planned development, on water, electricity and other social infrastructure and services including housing, only began in the late 1980s with the strengthening of the commercial sector that allowed for private investment and the passage of the AVF Act, 1988, that opened up funding channels from the Government of India. After the conflict with the Sri Aurobindo Society, and with substantial land rejuvenation work enabling infrastructure development, Thomas and Thomas note:

⁵⁴⁸ Doctor-Pingel, 2022.

⁵⁴⁹ Thomas and Thomas, 2013, 62.

⁵⁵⁰ Thomas and Thomas, 2013, 62-3.

⁵⁵¹ TDC Annual Development Plan, 2014-15, 20.

Administrative committees and positions were created within Auroville, and a period of relative economic and ‘political’ stability followed. A vivid illustration is a remarkable focus on the construction of houses from then on. Many residents gave up on the simple accommodation considered adequate up to that time, such as capsules made of ‘keet’ (thatched roof) and casuarina, and spent time on constructing their homes and improving the infrastructure of their particular communities. By 1983, there were many more communities, including Aurodam, Djaima, Amba Garden, La Ferme, Revelation, Dana, Samriddhi, Meadow ... ⁵⁵²

ii. *Semi-Planned Approach to Housing Development, 1980s-2008*

The Auroville Development Group and Auroville’s Future (a town planning consultancy) were formed at this time to draft Auroville’s Development Schemes between 1988-1999. The Development Schemes (1988-90 and 1990-1995) took forward the vision of housing in the five sectors of the Residential Zone as envisaged in the Detailed Galaxy Plan. These schemes proposed targets of number of collective housing units (4 buildings with over 50 apartments) and new-comer housing units (600 units) to be built and estimated the costs for the same (Rs. 9.05 Cr.) Research into construction technology involving innovations in the use of vernacular material and architecture was accordingly prioritized. The archival document also serves as an interesting historical artefact, which we produce below:

ESTIMATED COST OF THE AUROVILLE DEVELOPMENT SCHEME		
I. Plan of Development 1988-90		
Infrastructure: Overview Phase I	Rs 2.88	Crores
Housing Development: Phase I	Rs 1.30	Crores
S.A.L.I.E.R.: Phase I	Rs 1.12	Crores
Newcomer Housing: Phase I	Rs 0.50	Crores
Total for 1988-1990:	Rs 5.80	Crores
II. Plan of Development 1990-95		
Infrastructure: Phase II	Rs 10.87	Crores
Housing Development: Phase II	Rs 4.75	Crores
Newcomer Housing: Phase II	Rs 2.50	Crores
Community Facilities	Rs 7.32	Crores
Organic Farming	Rs 2.00	Crores
Village	Rs 1.65	Crores
Alternative Energy	Rs 2.50	Crores
Environment	Rs 1.28	Crores
Sports and Physical Education	Rs 0.90	Crores
S.A.L.I.E.R.: Phase II	Rs 7.11	Crores
Other Projects I	Rs 0.77	Crores
Other Projects II	Rs 2.15	Crores
Bharat Nivas: Phase I	Rs 2.00	Crores
CMRHU: Phase I	Rs 5.00	Crores
Total for 1990-1995:	Rs 50.80	Crores
TOTAL FOR THE DEVELOPMENT SCHEME OF AUROVILLE:	Rs 56.60	Crores

(Cost estimates for housing development between 1988-1995. *Source:* Auroville Development Schemes, 1988-90, 1990-95)

However, records indicate that funding concerns and ‘organic’ development, alongside slow population growth rates, did not allow for the planned targets to be met. For the remainder of

⁵⁵² Thomas and Thomas, 2013, 75.

the duration of the Auroville Development Scheme, between 1992-1999, Auroville's Future and the Development Group received Rs. 10 lakhs, a small sum by any measure for what it envisioned. How the funds were channelled precisely to housing development is not clear in the records, though our archival survey is incomplete. Concerns with the emerging sprawl, now intensified, were voiced at the time. Thomas and Thomas note, quoting Ryckaert's *Building Homes in Auroville*:

With the growing membership and rising income, along with the rapid development of the surrounding Indian economy, infrastructural requirements in terms of sufficient and adequate housing for Newcomers and the need for catering to the rapid increase in mobility far extended the economic possibilities of the community. From early on, housing had been in practice the responsibility of the Aurovilians themselves. This resulted mainly in small groupings of individually oriented places to live, with differentiation in quality ranging from 'tree houses' to aesthetically pleasing bungalows, often with a strong ecological orientation, like recycling of waste water and use of solar panels.

Collective housing had been experimented with in a community called Aspiration, established in 1969. Auroville's largest settlement at that time, and still existing today, Aspiration showcased the possibility of simple homes made of local materials and thatched roofs. The features of this community, which have endured over time, are provision of housing, a collective kitchen in which all participate, regular decision-making meetings, and proximity to school buildings, which also offer facilities for activities and recreation of community members.

The 80s and 90s saw a proliferation of individual houses, constructed in different sizes and architectural styles and using a wide range of materials, including ferrocement, rammed earth, and pressed earth-blocks. Most of these homes were single standing, though experiments with close clusters and row housing started in a considerable number of settlements during this period. As the community became increasingly aware of the need for urban density and cautious use of its land resources, construction of collective apartment facilities was taken up during the last decade. A wide range of multi-storied buildings, some designed for over 100 residents, appeared in Auroville's residential zone.⁵⁵³

By the turn of the century, about 70 residences housing 200 people had come up within what was to be the Residential Zone.⁵⁵⁴ There were a total of 95 residential communities (with the smallest at 3 and largest at 80 units), some outside the plan area occupying 100 hectares, or approximately 43% of the urban area.⁵⁵⁵ A total of 767 housing units, comprising individual dwellings, community housing, apartments and youth hostels, with an average household size of two adding up to 1534 residents plus minors. Significant experiments in building technology including stabilized earth blocks, rammed earth, fire bricks etc., were undertaken, which 'will have far-reaching implications in terms of design and materials, of reduction in energy consumption ...'⁵⁵⁶

⁵⁵³ Thomas and Thomas, 2013, 91.

⁵⁵⁴ Residents' Assembly Masterplan, 1999.

⁵⁵⁵ Masterplan, 2001, para. 1.5.3(b).

⁵⁵⁶ Masterplan, 2001, para. 1.8.2.

The Residents' Assembly 1999 Masterplan indicated that 'initial development of the Residential Zone in sectors 1 and 2 had begun only since the last five years.'⁵⁵⁷ In order to accelerate housing development, it proposed (i) fast-tracking the consolidation of land holdings to aid in building collective housing and (ii) guidelines for the development of the Residential Zone Sectors 1 & 2 (a policy taken forward in later years, with limited success), including limiting the living space per person to 60 sq. metres, providing a diversity of densities and architectural form, housing interspersed with community facilities and environmentally friendly methods of waste disposal, water management etc. By proposing to undertake these strategies, the draft Masterplan targeted the construction of 3,000 housing units by the year 2010 that could accommodate 10,000 additional Aurovilians. A sustainable mode of financing housing development was not elaborated, apart from concentrating on funding through donations, an unlikely strategy for housing development.

In a similar vein, the 2001 Masterplan presented a draft Five-Year Development Plan for 2001-2006.⁵⁵⁸ As we discussed in Part III.A, it targeted an increase in population growth in Auroville to 15,000 by 2010, with 73% of this estimated population growth was expected to be accommodated in the Residential Zone on a net area of 100 ha with average density of 240 persons/ha and 30 sq. meters floor space per person, a significant reduction from the 1999 plan. Taking forward the vision for distribution of densities and appropriate housing mix in the Detailed Galaxy Plan, the Masterplan proposed a mix of single family, low-rise and high-rise apartments with densities lower close to the Crown area and increasing outward towards the peripheral green belt area. Collective housing projects such as 'Creativity' and 'Progress' (on the Line of Force) were proposed in Residential Sector 1 and 2, along with the development of the Crown including community facilities and services. A total of Rs. 107 Cr. Was proposed for the development of the Residential Zone between 2001-2006.⁵⁵⁹

This was followed by the Directions for Growth Report in 2003.⁵⁶⁰ Following funding received under the Asia Urbs Programme of the European Commission in 2000, several studies were conducted under the Auroville Innovative Urban Management Project. In this, a set of guidelines for growth were published in 2003 for the five-year period between 2003-2008. To this end, the growth in population by 2008 was estimated to be 5,000 with a majority in the working age group of 20-59 years, accommodated in the Residential Zone.

Table 7: Estimated Age Groups of Aurovilians – 2025

Age group	Year 2008			Year 2025
	Total	Men	Women	Total
0-19	1330	665	665	17000
20-59	3335	2000	1335	28000
60+	335	135	200	5000
All age groups	5,000	2,800	2,200	50,000

Table 9: Distribution of Population – Ultimate & Current Phase

Zone	Ultimate	Current Phase
Residential	40,000	3,750
International	600	100
Industrial	1,800	300
Cultural	600	100
City Centre	5,000	450
Green Belt	2,000*	300*
All Zones	50,000	5,000

⁵⁵⁷ Residents' Assembly Masterplan, 1999, 18.

⁵⁵⁸ Masterplan, 2001, para. 2.10.1.

⁵⁵⁹ Masterplan, 2001, Table 22.

⁵⁶⁰ Directions for Growth, 2003.

Residential	%	Population (nos)	Sub total	No of units @ 2.5 people/ family unit	Res. area @ 40 sq mt/person as BUA	Sub Total	Social infrastructure @ 8 sqm/person as BUA
A - Individual Houses	20	750		300	30000		
B - Group Housing - low rise	40	1500		600	60000		
C - Apartment - high rise	40	1500	3750	600	60000	150000	30000
Cultural							
B - Group Housing - low rise		100	100	40	4000	4000	800
Industrial							
B - Group Housing - low rise	40	120		48	4800		
C - Apartment - high rise	60	180	300	72	7200	12000	2400
International							
C - Apartment - high rise		100	100	40	4000	4000	800
Habitat (City Centre)							
C - Apartment - high rise		350	350	140	14000	14000	2800
Crown (City Centre)							
C - Apartment - high rise		100	100	40	4000	4000	800
Green Belt							
		300	300	120	12000	12000	2400
Total		5000	5000	2000	20000	200000	40000

(Top, projected population growth and their zone-wise distribution (estimated for the year 2008). Bottom, zone-wise population projections. *Source*: Directions for Growth, 2003, 22-3, 40-1)

The residential densities at the time – between 8 and 16 person per hectare – were naturally lower than the early planning proposals, given the population growth rate discussed in Part III.A:

Sl No	Community Name	Total Area (Ha)	Ground Coverage (%)	Total Built Up Area (BUA) (Sq.m.)	Existing Population (Nos)	Existing Built Up Area per person (Sq.m.)	Existing Density PPHa
1	Gaia II	1.26	1.90	283.13	20	14	16
2	Grace	2.11	6.25	1857.74	27	69	13
3	Surrender	2.16	10.40	2365.92	46	51	21
4	Invocation	1.29	15.20	1747.96	20	87	16
5	Madhuca	0.94	8.15	830.56	14	59	15
6	Victory	0.30	3.65	160.00	3	53	10
7	Arati	1.17	5.23	877.95	10	88	9
8	Sukhavati	1.16	4.46	768.50	9	85	8
Total		10.37	7.48	8891.75	149	Avg for Sector 63	
Area under Green Corridors		3.98					
Existing open space/ vacant land		12.29					
Total Sector Area		26.64					
Total Proposed Population		1500					
Proposed Sector Gross Density (Persons per Hectare)		66					

(Built development, 2003. *Source*: Directions for Growth, 2003, Annexure 9)

Accordingly, the housing development plan for 2003-2008 emphasized the following considerations. First, a shift from the existing pattern of individual/ 'self-sufficient independent' housing and dispersed youth hostels to planned collective housing projects. Second, concentration of new clusters of collective housing development in Sectors 1 and 2 of the Residential Zone, still the planning emphasis today for the Zone, and gradually around the City Centre. Third, continued experimentation in new, vernacular housing construction technology (for example, promoting the use of the fired brick house). Fourth, community amenities at the neighbourhood level, developed along with housing construction, to enable a 'spiritual collective life'. This takes forward the vision of creating 'neighbourhoods' and 'wards' envisaged in the early planning proposals for Auroville in Anger's 'First proposal' of 1965 and the Detailed Galaxy Plan 1969.

Population	Nature of Facility		Population Threshold	Area
Neighbourhood level	Education	Crèche / Tot-lots	1-4 sq. m. / person	100-400 sq. m.
	Health	Dispensary	1 for 600 persons	0.5-0.8 ha.
	Culture	Neighbourhood room (hall, office etc.)	150-600 persons	500-660 sq. m.
	Services	Community kitchen, dining, laundry	150-600 persons	500-2000 sq. m.
		Water treatment plants	150-600 persons	500-1000 sq. m.
	Retail	Shops		
	Recreation	Neighbourhood park	--	10% of total area

(Neighbourhood-level service clusters. *Source*: Directions for Growth, 2003, 30.)

Fifth, in particular, responding to concerns with the growing sprawl, with a noticeable trend of loosely spread individual housing units mingling alongside early collective housing models, it notes: '[one] of the main underlying principles of Auroville is to encourage collective neighbourhood living as opposed to living in self-sufficient independent households. This aspect is most crucial for Auroville's development, as in addition to saving on land space Aurovilians will be largely freed from such routine work as cooking, washing, maintenance of buildings, etc, to put all their time into advancing the wider interests of the township; into living a more spiritual collective life; and ultimately into progressing towards the ideal of human unity.'⁵⁶¹

Thus, from the 1980s to the mid-2000s, the plans for Auroville in relation to housing development, evolved through several practical considerations such as consolidation of land,

⁵⁶¹ Directions for Growth, 2003, 29-30.

financing, determining design guidelines and setting population targets to estimate the housing demand. A thrust towards encouraging research in vernacular housing construction technology was particularly important, with the emergence of compressed earth blocks, ferrocement and other works led by the Auroville Earth Institute, Centre for Scientific Research and others.⁵⁶² This period also grappled, with variable emphasis over the years, with the question of how to leverage the physical design process of housing development as a means to nurture a society of communal living with ‘quietude and personal growth’. The architectural possibilities that lay in matching form to spiritual function inspired a number of diverse architectural projects, many widely acclaimed for their design innovations and environmental ethic.⁵⁶³

However, discussion of these considerations took place outside of the planned framework i.e., they did not unfold within the structure of a five-yearly Development Plan (‘DP’) that the Masterplan and URDPFI Guidelines anticipated, including the roadmap for two five-year DPs (2001-2006 and 2003-2008) in relation to housing suggested at the time, with a focus on the development of the Residential Zone Sectors 1 and 2, which were unmet. Further, in this phase, while a major focus on design considerations and physical urban form is noted, the want of financial planning and ability to attract newcomers to Auroville surfaced as a key missing piece in accelerating housing development. As a response, one sees a distinct shift from around 2009, where strategies for housing development now centred on economic self-sufficiency, with an explicit focus on producing a five-yearly development plan for Auroville.

iii. Housing Strategy Prioritizing Economic Self-Sufficiency, 2009- 2019

The years between 2009-19 saw a recurrent wave of planning studies, though as in city-planning in general, few translated to action. In any case, a review of these documents is useful, to understand the historical trajectory of the housing landscape in Auroville and identify pending challenges.

In 2009, the Integral Sustainability Platform (‘ISP’, discussed above in Part III.A) was initiated as a collaborative planning endeavour involving Aurovilians with expertise in their domains organized into 18 ‘sector planning teams’ across the themes of physical, social infrastructure and natural environment.⁵⁶⁴ The aim was to produce a DP for the year 2010-2015. As of 2009, Auroville had a total of 54 housing units including 29 existing/developed units and 24 under construction. These units were dispersed across the township area with a significant number of units lying outside the designated Residential Zone and some outside the city limits in the Green Belt.

⁵⁶² Thomas and Thomas, 2013, 87-91.

⁵⁶³ See, for example, Auroville Architecture, Prisma; Auroville Today, November, 2017; Kundoo, 2001, 2007, 2008, 2009; Mandeem, 2014; Louis, 2018; Ciconesi and Ciconesi, 2012; Srivathsan, 2023; Desai, 2019; Miles, 2007; Integral Architecture, 2017; Ajani, 2005; Doctor-Pingel, 2012, and particularly, Doctor-Pingel’s introduction in this volume for a beautiful summary of the humble and hard beginnings to where architecture in Auroville stands today.

⁵⁶⁴ Dinur and Yakolchik, 2009.

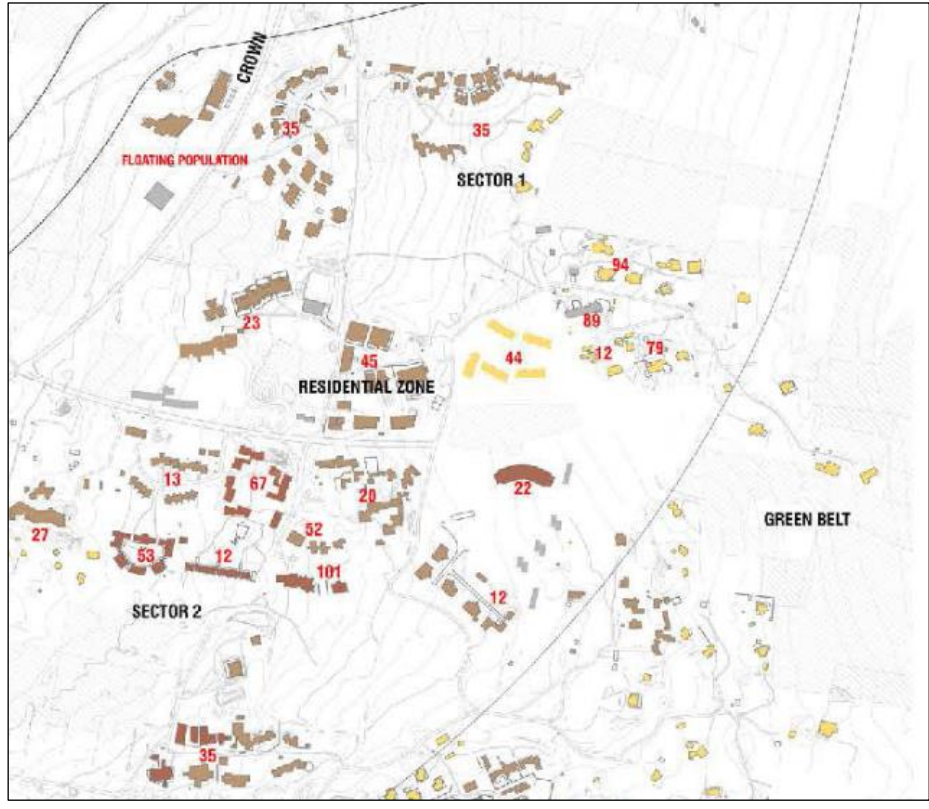
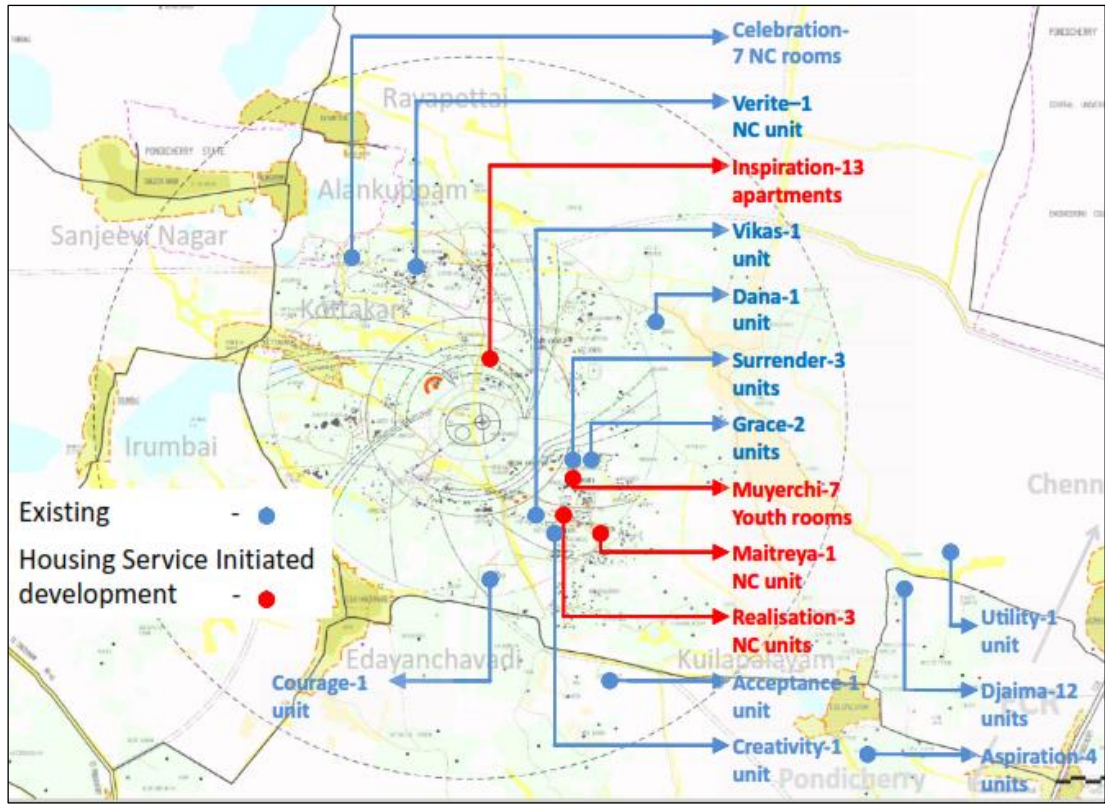

(Left, existing housing development, 2009; population distribution, 2013. Source: Dinur and Yakolchik, 2009, 96; Feduchi, 2014, 84)

The ISP strategy thus underscored the need for action in the following areas:

- i. *Financial self-sufficiency*, through a housing loan fund co-organized with the economy sector and by strengthening contributions from commercial units, a strategy that presupposes structural changes to Auroville's commercial profile, as we discuss in Part III.E.
- ii. *Organizational and administrative strengthening*, through the creation of a dedicated Housing Office with human resource capacity building.
- iii. *Planned integrated development*, facilitated by a 'Housing Assets and Management Policy', by exploring alternate temporary accommodations for newcomers such as through renting and liaising with nearby villages, alongside trust building with the community especially along the Green Belt to develop housing solutions.
- iv. *Strengthening existing research in housing technology*, an area in which a few pioneering units and architects have carved out a niche.
- v. *Teachers-housing*, close to schools as a priority area for SAIER.

While a Housing Service was created along with a Housing Policy in 2011 (later the 2021 Housing Mandate), the ISP process did not yield a comprehensive five-year development plan for the 2010-2015 period to enable a systematic execution of priorities identified at the time. The 2011 Housing Policy, for its part, provided a broad institutional framework of rules, mandates and guidelines to (i) manage existing housing units including their allocation, stewardship and repairs, (ii) develop new housing, (iii) regulate self-constructed housing by (iv) defining the mandate of the Housing Service and the Funds and Assets Management Committee.⁵⁶⁵ The following principles are outlined, which is to the best of our understanding the first exercise at codifying housing policy in Auroville:

First, no ownership and responsible stewardship: there is no private ownership of land or property in Auroville, and thus all Aurovilians are considered stewards/caretakers of land/housing. This means that the housing unit 'cannot be taken advantage of for personal profit and cannot be transferred into a guest house'.⁵⁶⁶ Thomas and Thomas summarize:

Homes in whichever form, from simple huts to beautifully-built residences, belong to the community and cannot be traded or sold as a commodity. Though most homes have been built with personal means, they are nobody's private property, and residents are considered to be stewards or caretakers of a community asset. From an economic angle, the analysis is rather straight- forward: given collective ownership, allocation of housing is decided upon by regulatory practices for which no market mechanism has been put in place ... Neither private ownership nor any purchasing of immovable property is permitted. Thus access to housing as well as the absence of an 'exit' arrangement [since instituted, but still subject to the need for price discovery]

⁵⁶⁵ Auroville Housing Policy, 2011; Housing Mandate: Governing the Allocation and Management of Residential Property Owned by the Auroville Foundation, 2021.

⁵⁶⁶ Auroville Housing Policy, 2011, 2.

are issues of great importance to individual Aurovilians that are settled by non-market mechanisms.⁵⁶⁷

As we discuss below in relation to Auroville’s commercial sector, working a non-ownership, stewardship formula requires mutual trust between the centralized administration and stewards. There is a distinction between non-ownership in the spiritual sense, as a progressive inner offering to the Divine, and in the legal sense, as an outer donation to the Auroville Foundation. As a matter of practice, the legal precarity of non-ownership, on one hand, and a *de facto* sense of possession natural to the *rajasic* temper, on the other, will each present challenges that will require a regulated exchange policy, which we discuss briefly below. Such a policy will in arriving at a workable formula that mediates between free-exchange – likely to lead to inequality concerns in the extreme until a generally diffused raising of the collective consciousness proceeds – and centralized allocations – likely to lead to inefficiency and moral hazards attendant to collectivism in the extreme. Concerns with semi-market-based ‘exchange’ of housing and centralized allocations have been voiced, including at the 2015 Retreat, yet usually in vague formulations.⁵⁶⁸ As we discuss in Part III.E, this will require careful policy choices – yet not codified – in meaningful dialogue with the complex literature on the subject, as a perhaps long pathway to the ideal of an unregulated and free yet fraternal exchange model that Sri Aurobindo outlines as the harmonization of the two extremes.⁵⁶⁹ Spatial justice concerns outlined in Part II arising out of scarce housing and land, with unequal entry-level financial positions of residents, will naturally bring in equity concerns, which are part of the challenge in regulating urban housing markets that Auroville must consider in its policy design.

This concern has been recognized in Auroville, often at a high level of generality, though the translation into a concrete policy framework is yet pending – for example, the 2015 Retreat outlines problems with the expected *rajasic* sense of possession, to note that ‘we need to engage with land stewards and work on an attitude change that reverses the trend of (some) land stewards behaving like land owners.’⁵⁷⁰ Alongside, it suggests that Auroville ‘cease (the) current practice of buying a house / all housing is stewarded in the best interest of the whole’, and identifies ‘Green Group attitudes’ as the ‘most critical challenge.’⁵⁷¹ Interestingly, the facilitators at the Retreat noted this concern ‘has not been translated in a milestone or action point’, a gap yet to be filled. The proposal at the time, ‘to institute (e.g. twice a year) the steward to report on the performance utilization’, may be a valuable one to consider, with a light and standard reporting format in the city-wide Governance Dashboard to allow for an evidenced, technology-leveraged planning approach to housing in Auroville. The concern here, as in the 2015 Retreat, was to the absence of any executive body, i.e., a defined Working Group, to anchor this process – we address this question in Part IV.

⁵⁶⁷ Thomas and Thomas, 2013, 91.

⁵⁶⁸ See, for example, Auroville Retreat, 2015, 21.

⁵⁶⁹ See, Hakimov and Kübler, 2019; Norris and Lawson, 2022; Truong et. al., 2020. See, for an overview of concerns in housing markets, Meulbauer and Murphy, 2008.

⁵⁷⁰ Auroville Retreat, 2015, 21.

⁵⁷¹ Auroville Retreat, 2015, 28, 49.

Second, responsible stewardship: alongside the no-ownership principle, the Housing Policy enjoins responsible stewardship.⁵⁷² Stewards are to look after repairs and maintenance of the house allocated to them either by self-financing or approaching the Housing Service for repair funds, while expected to ‘make a contribution towards the collective payment of the yearly housing tax.’⁵⁷³ Though Mother had indicated that there would be no ‘taxes as such’ in Auroville, communal contributions were expected.⁵⁷⁴ A change of nomenclature may be considered here in the policy. More substantively:

- i. Given the limited outlay of the City Services Budget for housing repairs (Rs. 24 lakhs in 21-22, for example), deductions for commercial unit executives who self-fund repairs and expenses may be considered, within specified limits.
- ii. Given the small-scale commercial profile at present, with limited surpluses subject to a flat 33% contribution requirement under the 2017 Code of Conduct, the FAMC may consider exemptions / credits for investment in housing, and a waiver of the ‘housing tax’ for a specific time-period (1-5 years), provided that incremental low-cost housing capacity is built alongside. As we note below in Part III. F, the disincentives to invest in the current economic setup make housing construction unlikely for those without prior savings.

Third, residence requirements: all residents have to live in Auroville on a ‘regular basis for at least nine months of a calendar year’ to be a steward of a housing unit.⁵⁷⁵ It is unclear here whether and how this requirement has been enforced since 2011, whether by self-assessments or otherwise. The concern with non-permanent residents was voiced repeatedly in our interviews. A portal for self-declaration of temporary exits exceeding one year may be instituted on the Governance Dashboard, to allow for efficient records.

Fourth, housing contributions: in allocating a house to a newcomer/resident, a donation/contribution is expected to be made by the steward to the Housing Service. In case of insufficient finances, the Housing Service could approach the unit in which the Aurovilian is employed for payment of contribution or it reserves the right to waive/provide full or partial

⁵⁷² As an area for future research, we may note that the practice of this ideal of responsible stewardship offers exciting possibilities for comparative work with justifications for property ownership in a fascinating and long-standing literature on the subject. Hefty reasons are presented in favour of ownership, which in fact Mother incorporates in her thinking as reasons for stewardship: for example, at the risk of over simplification, for Hegel, owning property served a pedagogic function, to build responsibility and a sense of duty, with a risk of under-utilization, improper care or irresponsible behaviour in alternate arrangements; for Locke, ownership is a *quid pro quo*, as just desert for one’s labour; for others, ownerships functions as an efficient, if at times inegalitarian, capital allocation mechanism. See, for example, Waldron, 1988. Equally, legal conceptualizations of property vary across a broad scale from negatively-cast exclusive rights to positive use-duties, with agenda-setting powers to determine resource-use, identifying a basket of entitlements and duties within the umbrella of ‘ownership’ that may be allocated and regulated in various permutations.⁵⁷² How Auroville’s model of responsible stewardship in service to the Divine interacts with these conceptualizations presents a rich area for study, both in terms of knowledge generation and informing policy specifications in light of past practice elsewhere. See, for example, Dagan, 2011; Katz, 2008.

⁵⁷³ Auroville Housing Policy, 2011, 2(c).

⁵⁷⁴ Guigan, 2018, Vol. 1, 220.

⁵⁷⁵ Auroville Housing Policy, 2011, 2(b).

grant towards payment. The concern with insufficient newcomer housing is critical, as we discuss below, given limited reserves in the Central Fund and the inability of most units to fund welfare, including housing.

Fifth, exit options: for self-constructed housing, the value of the unit is expected to be communicated to the Housing Service, reclaimable if the Aurovilian decides to permanently leave (conditional on the positive record of the Aurovilian). This is an important expression of goodwill from the community, and one that can be extended to commercial enterprises as well. As far as we are aware, an efficient price discovery mechanism is still to be introduced.

In general, the Housing Policy 2011 marked a move forward in codifying customary practices in the community at the time, a necessary advance to centralized planning of the sector. The thrust of the policy, however, is on regulation of existing housing rather than growth and development. Accordingly, two years after, the Implementation and Development Phasing Program, 2014, discussed in Part III.A, focussed on these growth concerns. It targeted a development strategy for a population of 5,000 people for the five-year period between 2013-2018, with little movement since the ISP, advocating ‘Affordable Co-created Housing Choices’ for Aurovilians, an option equally relevant today.⁵⁷⁶ It emphasized six issues:

First, an integrated plan to improve housing supply and demand: by encouraging incremental new housing development in each of the four Zones at a targeted 100-150 housing units per year between 2013-2018, along with a needs-driven approach to housing supply. This included proposals to create a housing database enabling a clear allocation-reallocation policy based on changing demands, compact housing design conducive to flexible use and institutionalizing the process of rentals for newcomers and Auroville employees through lease-to-own options and rental of additional spaces in existing units (such as guest rooms).

Second, a diversity of housing choices: to cater to diverse needs of populations from medium-low density housing for individuals (at 30 sq. metres) and families (of four, at 100 sq. meters) – both in line with Anger’s suggestions approved by Mother and the 2003 *Directions for Growth* report – live-work units for employees and teachers in proximity to workplaces/school campuses in and around the Industrial and Cultural Zones, low density innovative housing options in the Green Belt area to self-constructed housing in mixed density settings to keep alive the spirit of experimentation in building materials and architecture.

Third, an affordable housing policy: defining standards of what affordability means in Auroville (particularly given inequality concerns discussed in Part III.E) and exploring varied mechanisms to encourage affordable housing (from loans/assistance for housing purchase to drafting housing allocation and rental policies). This strategy proposed evolving networks with domestic and international funding agencies (including the World Bank, SEWA Bank, Micro-Finance Housing Corporation etc.) to raise capital, partnerships with private and non-profit providers/developers of affordable housing (Micro Home Solutions (Delhi), DBS Affordable Home Strategy Ltd., Tata Housing).

⁵⁷⁶ Kalra, 2014, 56-65.

Fourth, incremental housing: by mandating incremental addition of capacity for all new residential construction, and a percentage of lower cost units (3-4 lakhs) in all planned residential developments.

Fifth, private sector involvement: self-sustaining channels by creating market-rate housing on lands outside the designated township sold/rented to Friends of Auroville/Auroville employees to cover housing shortage within Auroville.

Sixth, market-rate housing in outlying lands: developing market-rate housing on the approximately 1100 acres of lands outside the plan area that may sold or rented to Friends of AV and AV employees such that the revenues generated from the profits is used to offset housing shortage inside Auroville.

Again, records indicate that no clear movement in terms of increasing access to housing stock through private investment or loans, nor regulations to determine allocation / reallocation, price discovery mechanisms, credit lines for newcomer housing or needs-based arrangements to address the inequality concern were made. However, progress was recorded at this time with the first draft development plan for the Residential Zone drafted by an external consultant, Feduchi, focussing on Sectors 1 and 2, in line with 2003 Directions for Growth proposal.

iv. Feduchi's 2014 Draft Development Plan for Residential Zone Sectors 1 and 2

Feduchi's plan attempted to detail out Anger's 1970 proposal in *Auroville, Study of the Town Plan – First Approach* along four axes: land use, movement, density and the urban form.⁵⁷⁷ At the time, in 2013, the only part of Anger's detailing that had been conceptualized, though still demarcation of the right of way was delayed, was the road layout. Feduchi's aim – each of which relate to early planning discussions between Anger and the Mother – was to work with two main housing typologies, a 'dense fabric of collective residences and the more autonomous cluster housing units':

Basing the decisions regarding the future development in the RZ on these parameters will safeguard a development that contributes to the city-scale, holistic vision rather than addressing solely the local needs. Moreover, keeping those parameters as outgoing (sic: ongoing) point for project development ensures cohesive yet varied development, responding to the ground realities and giving space for architects' innovation.⁵⁷⁸

The following points emerge from Feduchi's treatment:

First, on mobility, Feduchi outlines two design features, facilitating intra-zone movement to reduce heavy circulation on the primary networks, particularly the Crown and Green Corridors, to serve the ecological imperative and protect environmentally sensitive areas.

Intra-zone movement: the draft plan works with the street hierarchy in Anger's 1970 concept – with the Crown, Ring Road, Radials as the primary networks, and secondary networks for

⁵⁷⁷ Feduchi, 2014, 15.

⁵⁷⁸ Feduchi, 2014, 97.

access to the Residential Zones – Feduchi emphasizes (as in the 2005-2011 Auroville’s Future, Crownways and Posch studies) a shift from vehicular movement patterns current at the time (and still so) to give priority to walking and cycling routes that follow the proposed Green Corridors layout, leading to the primary networks for collective and emergency transport. As we discussed in Part III.A, this is a common emphasis in planning documents, from Anger’s first study to the 2022 Dreamweaving exercise. In this, Feduchi identifies – as Posch in 2008-2011, and a problem still – hindrances to intra-zone mobility caused by gating and fencing, which force movement onto the Crown leading in turn to inefficient flows and noise pollution on the primary networks. For this, the ‘dead areas’ or ‘negative spaces’ in Sectors 1 and 2 are leveraged, to keep movement within the zones.⁵⁷⁹ Feduchi outlines the underlying philosophy behind his planning approach:

[The] presence of a walkable realm and the biodiversity is prioritized over the vehicles and roads. Lifestyle oriented towards the walking and cycling is to be promoted and facilitated by every development to come in the RZ.⁵⁸⁰

Green Corridors: given the ecological imperative, these corridors, suggested earlier in Kundoo’s 2007 City Centre Study, are to secure a 50% green cover *within* the city, a practical means to ensure an ecologically sensitive urbanism, the heated ‘elephant in the room’ as we discussed in Part II. The Green Corridors are thus conceptualized as a network of greenery penetrating the built urban fabric of the two sectors, shifting the gravity of movements inwards to the zones rather than to the primary networks. Among other things, this, we may note, carries with it an emphasis on developing an urban form that support a communal social fabric, again a repeated emphasis from Mother’s response to Anger in 1965 to the Dreamweaving exercise in 2022. Imagined as beautiful, refreshing veins within the built fabric, they are to have a provision for vegetation and water percolation, with existing greenery, biodiversity to be allowed to flourish. Equally, Feduchi attempted to work with environmentally sensitive areas and where possible, respond to watershed patterns, suggested in the 2013 Land Suitability and Land Use and Water Sourcing studies. It appears though that this resolution was nonetheless rejected later, as the Town Development Council’s 2015 report records the failure to adopt Feduchi’s plan as owing to the chronic inability to integrate the Galaxy concept with on-ground geospatial concerns. We were not able to determine, however, precisely which aspect of Feduchi’s plan was objectionable.

⁵⁷⁹ Feduchi, 2014, 83, 65-71, 111.

⁵⁸⁰ Feduchi, 2014, 65.

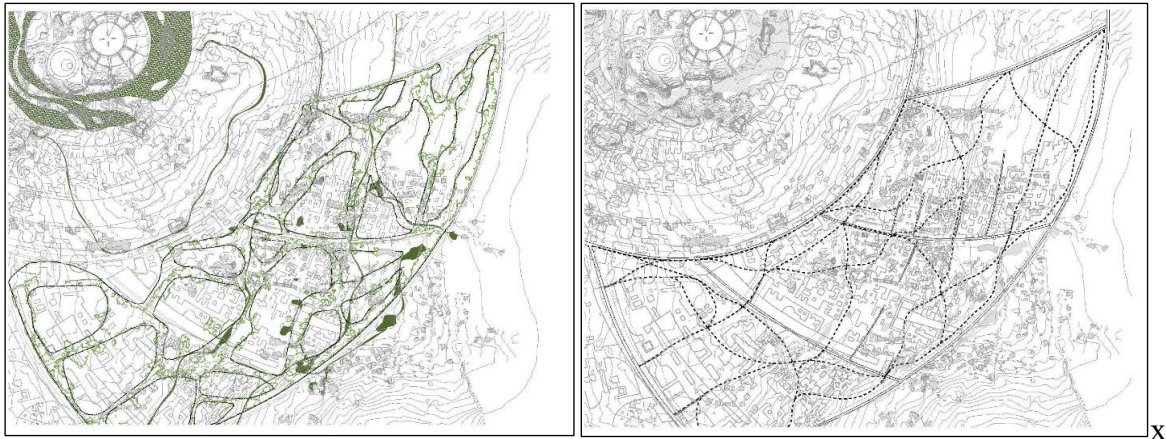

(Left, Green Corridor layout. Right, Cyclepath routes. Source: Feduchi, 2014, 22-4)

Second, on density and urban form, Feduchi outlines six features, each reflecting early planning conversations with Mother, (i) the need to define zonal plans, built form and population distribution, for systematic future planning that can manifest the form of the Galaxy, (ii) redefining fencing and boundaries that have emerged over time, in consultation with stewards, to redefine the form, (iii) designing public spaces, open and closed, to generate a cohesive social fabric, (iv) integrating zonal development with the Crown, to design a permeable interface, with the Crown serving as a centripetal, communal force for uses other than heavy mobility, and (vi) increased and representative densification to avoid a sprawl.

Signal for systematic future planning to manifest the Galaxy: Working with population distribution in the 2010 Land Development Plan, which incorporates distribution and population targets from the Directions for Growth Study, Feduchi proposes built fabric heights in the two zones in an attempt to capture Anger’s visually-appealing Galaxy Model, yet to be worked out in relation to ground realities. As the Galaxy determines, or ought to, the ‘general arrangement of the built form: inform the rhythm, sequence of open spaces, courtyards etc.’, Feduchi notes that his plan ‘gives an indication as to how the future development is to constitute a part of the Galaxy form.’⁵⁸¹ This, as he notes, is important to signal and guide to future development if the form of the Galaxy is to be realized on ground incrementally:

... strategy sets as the main target the manifestation of Roger Anger’s city concept, as presented by the Galaxy Model (1968) in the built environment of Auroville ... the analysis of the three-dimensional Galaxy form and a provisional 40 m² per person guide ... results in a set of varied densities that, in reality, translate into a build environment that reads as a *Galaxy* shape not only in plan but also identifiable on the ground.⁵⁸²

Redefining boundaries, fencing: a bone of contention given existing habitation patterns that led to the eventual (in effect, rejection) of the plan, Feduchi notes that his plan intends to ‘redefine, as they stand, ‘plots’.⁵⁸³ The objective is to ‘move on from a realm that operates

⁵⁸¹ Feduchi, 2014, 105, 111.

⁵⁸² Feduchi, 2014, 105, 83.

⁵⁸³ Feduchi, 2014, 105, 87.

with a fence line or a shape of the land, as it was acquired, as a base for defining and dividing Auroville.⁵⁸⁴ Accordingly, the ‘virtual DU [development unit, public space, green corridor or residential] boundaries serve merely for logistic purposes (like assigning FAR or projected population for the particular area), rather than giving an indication of the physical boundaries or divisions that lead to the isolation and fragmentation of the City.’⁵⁸⁵ The plan anticipates that projects will ultimately be allocated ‘to a DU that suits the proposed use, the number of accommodation units, the desired character of the development etc. ... whilst certain projects might be suitable for several DU’s which will present L’Avenir, the project holder and the architect with options to choose from.’⁵⁸⁶ It appears that the relatively unsystematic growth of the zones require redefinition to align with the overall form of the Galaxy, which will require existing ‘boundaries’ to be renegotiated for the whole. As the TDC-TOR notes, as did Mother in relation to early resettlement considerations, individual housing and settlements may, as plans emerge, need to be flexible, indeed consent to inconvenience, to accommodate the collective project.⁵⁸⁷

Public spaces and a socially cohesive urban fabric: the concern with maintaining open, public spaces and generating greater exchange among residents to allow for a cohesive social fabric is central in Feduchi’s plan. Feduchi’s plan builds on the 2010 Urban Design Guidelines that aimed to ‘decode’ the Galaxy concept in Sectors 1 and 2 to achieve ‘a critical density required in sectors 1 and 2 while maintaining a significant green space’, by identifying Green and Urban Zones.⁵⁸⁸ the former allow for clustered housing with a small amount of fenced off land directly around the housing units for privacy and security, but are largely to remain uninhibited for free movement and green cover, while the latter are given entirely for ‘active public uses’ to provide spaces to gather and recover the ‘old warmth’ of community.⁵⁸⁹ This, as we noted in Part II, was an important design feature in early planning conversations with Mother, to avoid alienation and dispersed settlements. In this, Feduchi defines the green areas – as early planning documents and Schmidt’s insightful 2003 essay again indicate – by the ‘reverse’ of the Galaxy shape, the areas filling the negative space between the mass of the Galaxy form.⁵⁹⁰ Particularly, Feduchi introduces Areas of Public Interest as standalone Development Units for public nodes of high importance, again stressing the need for a communal orientation to bring together the residents in common spaces. This concern with cohesiveness has been repeatedly emphasized in the records from 2003 onwards, being a persistent point of concern both in terms of design and the ideal of unity in close quarters that is to bind the Residential Zone – for example, the Annual Report of the Auroville Foundation notes in 2011-12 that ‘the (Residential Zone) layout ensures

⁵⁸⁴ Feduchi, 2014, 105, 87.

⁵⁸⁵ Feduchi, 2014, 105, 87.

⁵⁸⁶ Feduchi, 2014, 105, 87.

⁵⁸⁷ Guigan, 2018, Vol. 1, 268-9; TDC, Terms of Reference, 2017, para. 2.2.1.1.

⁵⁸⁸ Feduchi, 2014, 49.

⁵⁸⁹ Angerm ‘=1’, 1968.

⁵⁹⁰ See, Schmidt, 2003, 1, 3 (‘Town planning starts with the street (and not with individual buildings, which are subordinate to it) ... The human quality of ... public spaces can play a major part in fostering ... experiences. The life that takes place in and between buildings seems almost always to rank as more essential and more relevant than the spaces and buildings themselves.) See, Part IV.E for a short discussion on Schmidt’s essay.

development of housing and services in clusters that can facilitate a more interactive social life and urban community feeling.’⁵⁹¹

Permeable, Centripetal and Communal Crown: an overarching concern in Feduchi’s plan, reflected in early conversations with Mother and studies since, is to generate an urban form that facilitates social interaction, whilst providing necessary space for solitude and quiet. The twin concerns of diversity, liberty and free play, on one hand, and cohesion and unification that guide Sri Aurobindo’s discussion in the *Ideal of Human Unity* are here sought to be translated materially in a built form. Feduchi notes that his proposed urban form ‘draws a base for a cohesive urban fabric, with a diversity of local characteristics, a sequence of public spaces and with qualities ensuring a lively and actively used city realm.’⁵⁹² Particularly, in relation to the Crown, Feduchi attempts to translate Anger’s early description discussed in Parts II and III.A, with the main movement spine on the Crown (crossing the two sectors) constituted by a pedestrian realm of covered walkways and pergolas connecting the built fabric on the ring to a sequence of open spaces, with a 6.7 meter service road on the outer edge for emergence access, public transport and limited motorized traffic (similar to 2005 Mobility Plan, and the broad vision of Posch, 2008-2011). Interestingly, Feduchi proposes ‘indicatory Urban Form guideline parameters’ to ensure a ‘coherent, continuous yet varied fabric reflecting the desired character of this vital part of the city’, not to be seen as the precise footprint of buildings but ‘a general direction for the arrangement and massing of the proposed buildings.’⁵⁹³ In this, a proposed interpretation was offered as a case study, which we extract below.

⁵⁹¹ Auroville Foundation Annual Report, 2011-12, 11.

⁵⁹² Feduchi, 2014, 105, 91.

⁵⁹³ Feduchi, 2014, 105, 125-128.

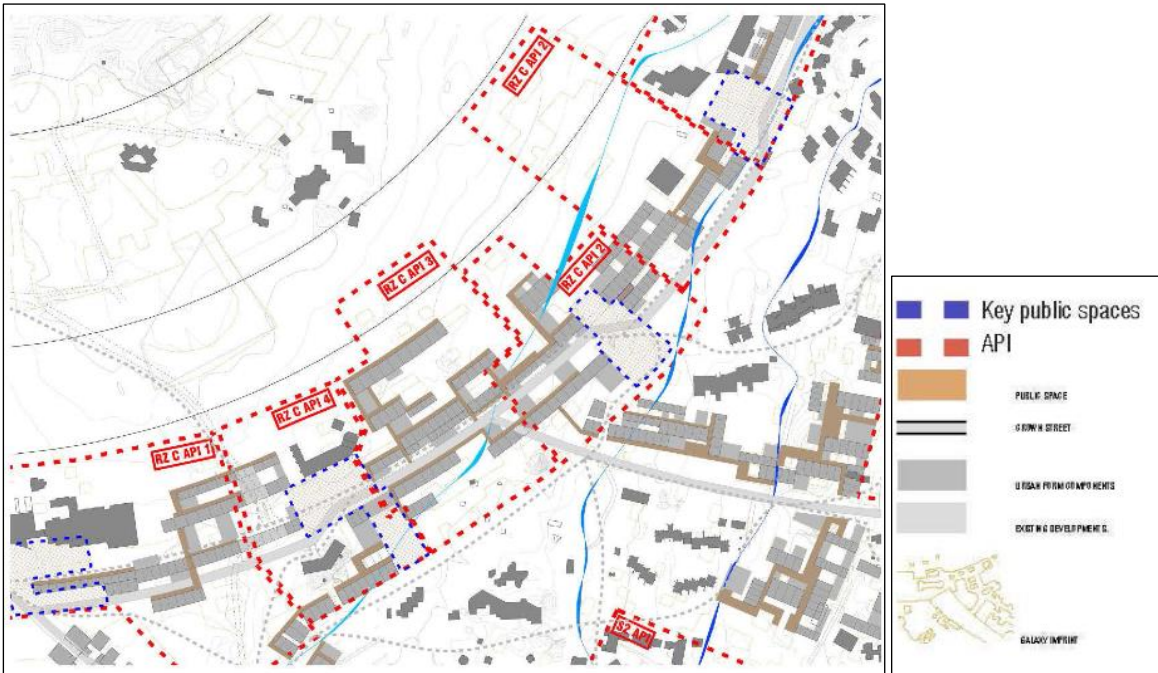

(Top, Crown urban form. Bottom, Indicatory urban form on the Crown, with a comparison of proposed projects in 2014 and those as against the indicated form. Source: Feduchi, 2014, 125, 128)

Representative Densities: on the important question of densities, discussed with reference to early planning discussion in Part II, Feduchi notes that the built mass of the Galaxy ‘translates into the specific building heights and the adequate population distribution’, and thus:

... projected population targets assigned to each Development Unit are based on a straightforward calculation combining the Galaxy Imprint, the Galaxy Model heights,

the expected 50 000 residences target (5 000 for the S 1&2) and the provisional guideline of 40m² per person.⁵⁹⁴

[These proposed densities are to] ‘ensure a development of a cohesive urban fabric with a range of the population densities throughout the city, a diversity of heights and a variety in the local built environment characteristics.’⁵⁹⁵

His figures, extracted below, are based on those proposed in the 2003 Directions for Growth and the 2013 Land Suitability and Land Use Proposal, broadly line with Anger’s 1965 document approved by Mother and the 1968 ‘first’ masterplan.

In this, Feduchi identified patterns of distribution of population densities and built-up area across urban and green zones in each of the sectors, and proposed primarily two housing typologies in line with the Detailed Galaxy Plan, i.e., moderate-high density collective housing units and low-density cluster housing units, with densities decreasing from west to east and heights increasing from the Matrimandir outward towards the peripheral Green Belt area.

⁵⁹⁴ Feduchi, 2014, 83.

⁵⁹⁵ Feduchi, 2014, 91.



URBAN ZONE

S1U		S2U	
Area	78,936 m ²	Area	107,397 m ²
Expected pp	1,174 pp	Expected pp	1,903 pp
Density	14,873 pp/km ²	Density	17,719 pp/km ²
Built up area	46,960 m ²	Built up area	76,120 m ²
Current pp	71 pp	Current pp	302 pp



GREEN ZONE

S1G		S2G	
Area	183,296 m ²	Area	99,114 m ²
Expected pp	321 pp	Expected pp	167 pp
Density	1,706 pp/km ²	Density	1,634 pp/km ²
Built up area	12,840 m ²	Built up area	6,680 m ²
Current pp	136 pp	Current pp	170 pp

S1R 100	16,574	140	5,600	
S1R 101	5,498	47	1,880	
S1R 102	21,687	183	7,320	45
S1R 103	9,866	83	3,320	
S1R 104	3,166	23	3,080	
S1R 105	15,652	132	5,280	
S1U 100	2,523	22	880	----
S1U 101	1,885	16	640	
S1U 102	1,160	10	400	
S1U 104	8,673	15	600	
S1U 105-6	1,708	72	2,920	44
S1U 107	1,380	12	480	12
S1U 108	9,317	79	3,160	
S1U 109	11,610	98	3,920	
S1U 110	11,098	94	3,760	14
TOTAL		488	19,520	71

total ground floor	183,296	318	1,706	
S1G 102	20,342	35	1,400	44
S1G 103	13,484	23	920	35
S1G 104	13,576	24	960	
S1G 105	20,479	35	1,400	57
S1G 106	3,026	6	240	
S1G 107	25,657	44	1,760	
S1G 108	57,673	99	3,960	
S1G 109	3,518	7	280	
S1G 110	9,042	16	640	
S1G 111	1,787	4	160	
S1G 112	2,081	4	160	
S1G 113	2,742	5	200	
S1G 114	1,567	3	120	
S1G 115	1,827	4	160	
TOTAL		321	12,840	136

(Population distribution methodology. Source: Feduchi, 2014, 93-5)

v. *Town Development Council, Annual Development Plan, 2014-15*

With this raft of planning work – the 2013 Land Suitability and Land Use Proposal, the 2013 Water Sourcing and Integrated Water Management study, the ISP, IDPP and finally, Feduchi's draft development plan – the TDC Annual Development Plan 2014-18, projecting a pathway for 2014-18, suggested strategies for action.⁵⁹⁶ The Annual Report of the Foundation for 2015-16, thus, records an optimistic note:

A Detailed Development Plan (DDP) was prepared, focusing on the Residential Zone which will become the first part of the town where development is carefully planned and controlled. DDP is based on the Master Plan (2001) and Architect of Auroville, Mr. Roger Anger's model of the development guidelines address a range of planning aspects on various layers: Land Use, Movement, Density and Urban Form. These provide the TDC with a comprehensive set of parameters for every plot of land and help allocate projects according to the use and character. In this financial year, a project was completed with the preparation of the LDU (Land Development Unit) that provide the identification of plots, building typology and assigned population for each of them.⁵⁹⁷

The TDC Annual Development Plan thus envisaged the development of compact residential settlements with a good mix of public and social amenities for a target critical mass of 5,000 people in the Residential Zone and City Centre areas 'in a relatively short time', by 2018.⁵⁹⁸ The development of the Residential Zone Sectors 1 and 2 was targeted at (i) bringing the 25% population living outside of the designated zone/city limits into the Residential Zone to address the sprawl and (ii) increasing densities 'to at least 50%, thus changing the social and urban dynamic.'⁵⁹⁹ The priority at the time, as it remains now, was identified as follows:

... [to] focus the development towards a more compact residential settlement taking care to integrate green areas, social services and public spaces for social interactions. At the moment approximately 25% of the Aurovilians live 'outside' the city area. Our objective is to focus on the growth of the Residential Zone and to concentrate up to 50% of inhabitants in this area within a relative short time. For housing this means that the TDC is planning a more compact form settlement as a transition from the present pattern of sprawled communities into a more connected type of urban environment. On the basis of the surface water and the land use studies an integrated planning will be developed for the residential sectors 1 & 2. Basic services & amenities for the planned resident population will be integrated locally thus reducing the for long distance mobility and promoting stronger social interaction.⁶⁰⁰

Alongside, as we discuss in Part III. F, the TDC's Annual Development Plan focussed – following from the ISP and IDPP – on the strengthening of the commercial sector – the 'social consolidation and growth of internal economy' – as indispensable to accompany the move to

⁵⁹⁶ TDC Annual Development Plan, 2014-15.

⁵⁹⁷ Auroville Foundation Annual Report, 2015-16, 10.

⁵⁹⁸ TDC Annual Development Plan, 2014-15, 20.

⁵⁹⁹ TDC Annual Development Plan, 2014-15, 28.

⁶⁰⁰ TDC Annual Development Plan, 2014-15, 20.

concentrated housing development.⁶⁰¹ Concerns of cyclical stagnation discussed in Part III.A and elaborated upon in Part III.F below, meant that the proposed increase in population numbers by 117% to 5000 residents in 2018 would be insufficient to cover increases in service infrastructure spending in the short-term till the added population generated productive contributions. An infusion of capital was thus identified as necessary to break this vicious cycle:

... a large expansion in Auroville population, will create a huge deficit in budgets unless the commercial units are helped to dramatically increase their income and contributions. This would need a large and focused effort in assisting units, existing and new, on all levels also financially.⁶⁰²

In this context, the plan proposed a total investment of Rs. 42.6 crore for housing and infrastructure (water, electricity) development in the Residential Zone Sectors 1 and 2 financed primarily by donors, with 350 apartment units in varied stages of development capable of housing approximately 500 people. This was to be accompanied by collective low-cost housing facilities integrated into the development of the Industrial Zone in the Auroshilpam area, Mangalam and Pony Farm.

At the end of this process, however, Feduchi's 2014 plan was not formalized. A 2015 letter from Dr. Doshi, Chairman of the Town Development Council to Chairman of the Governing Board notes that the plan was presented to 'most of the architects and other community members ... and [their] constructive and positive response indicates that we can fulfil the ... deadline' of one year under the NTDA option being considered at the time'.⁶⁰³ Three concerns were identified in relation to lack of action to formalize the plan: first, difficulty to harness residents' support to embark on action-oriented planning practices and a collaborative governance system; second, existing stewardship realities leading to constant negotiations / mediations, hindering development of a shared plan for the city; and third, insufficient integration with ground realities in Feduchi's plan.

The first two reflect chronic governance concerns common to most sectors, which we discuss in Part IV. For the third concern, we may reiterate that Feduchi's plan sought to incorporate Anger's 1969 detailed Galaxy model, Kundoo's 2007 City Centre Proposal, the 2003 Directions for Growth and 2014 Land Suitability and Land Use and Water Sourcing and Management reports. The emphasis, priority in Mother's early conversations, was on the need for a cohesive urban fabric as central to the Auroville experiment for unity in close quarters, at density. In this, Feduchi reflected concerns on different ends of the spectrum, the Galaxy and geospatial realities, increased densification and relative quietude. As such, interviews did not reveal the precise scope of the disagreement that led to its *de facto* rejection; yet, at any rate, what remains worrying is the absence of execution-oriented community dialogue on the 2014 draft (as a template if not a settled document, for further amendment to accommodate concerns) to arrive at a common Development Plan that may incrementally manifest the Galaxy form. This indicates either intractable divisions or a general lack of urgency or willingness to manifest the urban form at scale, with interviews suggesting both.

⁶⁰¹ TDC Annual Development Plan, 2014-15, 25.

⁶⁰² TDC Annual Development Plan, 2014-15, 9.

⁶⁰³ Doshi, 2015, 2.

The next two major documents to consider housing in Auroville highlight these concerns pertaining to execution: the 2015 Auroville Retreat and Ayer et. al. in 2019. The Retreat highlights – though as with most ‘milestones’, without specific action plans – the need for affordable housing for newcomers and Auroville youth, and an identification of financing options for short-term housing loans. It commits to building 2000 affordable houses of ‘sophisticated simplicity, beauty and sustainability’ by 2020, with a focus on increased densification of Sectors 1 and 2 (though oddly Feduchi’s plan is not mentioned in the discussions); speed up building permissions processes; create ‘affordable housing for teachers and researchers by 2017’; ‘[create] 500 units of housing / basic short-term accommodation not funded by individuals but by other means [not identified] for all those ready to commit and work for Auroville’ by 2018; development of outlying lands.⁶⁰⁴ The proposal was also mooted for 10% of the Unity Fund Budget and 10-15% of the Government of India Plan Grants to be routed to housing, though it is unclear how planned grants for other purposes can be utilized for housing.⁶⁰⁵ Notably, the governance concern persists here, as the bodies to implement these goals are identified as ‘FAMC, BCC, ABC, LRD, Land Board, Schools’, excluding the Housing Service and TDC, reasons for which were not clear, though without any clear specification of executive powers.⁶⁰⁶

Subsequently, in 2019, Ayer et. al. identified the lack of sufficient housing stock as an impediment to engage skilled persons, necessary for the growth of the tertiary research profile of Auroville, as also the primary bottleneck for drawing a younger population of 20-50 year-olds, necessary for the demographic profile.⁶⁰⁷ Accordingly, they identify the ‘enormous need for developed plots & housing loans for incremental housing’ as the priority for the sector.⁶⁰⁸ It bears noting that all but one member of the Housing Service (who had operational objections) noted that they ‘full agree with the ... priorities ... [and] sincerely hope that the proposed new policies will be approved and put into practice soon’.⁶⁰⁹ A joint committee between the TDC, FAMC and Housing Board was proposed by the Auroville Council based on this recommendation.⁶¹⁰ To the best of our understanding, neither the 2015 Retreat ‘milestones’ nor Ayer et. al.’s housing priorities were translated into actions plans.

In sum, the fairly intense planning activity in this period from 2007-19 – with seven ‘major’ reports / proposals / draft plans and approximately 30 ‘minor’ studies / surveys – thus did not translate into a detailed development plan for the Residential Zone, or identify feasible funding

⁶⁰⁴ Auroville Retreat, 2015, 21, 34, 36, 43 (inline comments ours).

⁶⁰⁵ Auroville Retreat, 2015, 53.

⁶⁰⁶ Auroville Retreat, 2015, 53. There is also a suggestion that youth ‘can make themselves houses and use materials available like mud, wood ... [including as part of the] school curriculum.’ Whilst a great learning opportunity that can be explored, the scale and ambition of housing development in Auroville would require a professionally driven and concerted approach.

⁶⁰⁷ Ayer et. al., 2019, 8, 26.

⁶⁰⁸ Ayer et. al., 2019, 8, 26, 40. The Housing Service team, with one exception, noted that they ‘fully agree with the Housing priorities presented ... [and] sincerely hope the proposed new policies will be approved and put into practice soon.’

⁶⁰⁹ Ayer et. al., 2019, 40.

⁶¹⁰ See, News and Notes No. 872, 2021, 5.

strategies to build or access borrowing for newcomer housing.⁶¹¹ A study of Annual Reports of the Auroville Foundation in this period reveals the persistence of these concerns: in 2005-6, it notes that ‘the major question needing attention is how to provide Aurovilians entirely supported by community funding with affordable housing’;⁶¹² in 2008-9, it notes that ‘[among] Auroville’s diverse needs, housing appears to be the pressing need and must be given top priority. The prevailing grave housing shortage is impeding Auroville’s growth’;⁶¹³ in 2013-14, it records that the ‘(Governing) Board directed that the Auroville TDC to give top priority to affordable and sustainable housing for new comers and Aurovilians and speed up the completion of sanctioned projects.’⁶¹⁴

The lack of coordinated planning to arrive at a systematic plan that may address these structural, and by no means easy to solve, concerns reveals, as in city-planning generally, a concern with undefined governance mechanisms that can balance the twin concerns of participation (and divergence of opinion, as is natural and expected) and authoritative decision-making, reflected in the scheme of ‘illuminated hierarchies with collective discipline’, Mother’s ‘qualified democratic’ suggestion for collective organization discussed in Parts I and IV. Simply put, it appears that the concern at the time, and indeed now, is not primarily technical, but one concerning a resistance to urbanize and to arrive at appropriate governance forms that can secure effective movement in that direction.

That said, this period, particularly since 2005, saw a range of housing projects develop across the plan area, many with a distinct and innovative architectural imprint that Auroville is now world-renowned for.⁶¹⁵ While capacity details were not available at the time of our research, approximately 500 beds were constructed / allocated across the following communities in this period in the following communities: Vikas, Creativity, Courage, Prarthna, Samasti, Luminosity, Realization, Inspiration, Citadines, Swayam, Arati, Invocation, Realization, Humanscapes, Sunship, Sanjana, Kriya (Project X and Project Y), SAIER Staff Quarters, Maitrye II, Vibrance, Grace and Humility.

⁶¹¹ See, Survey on collective housing was undertaken by the APDC to analyze the various factors involved in developing collective housing projects (Auroville Foundation Annual Report, 2004-05, 11); APDC proposal with regard to future housing development within the City area (Auroville Foundation Annual Report, 2005-06, 24); Complete survey of all the building assets of the Foundation (Auroville Foundation Annual Report, 2010-11, 96); Five Year Plan (2012-2017) for infrastructure, housing and public funding (Auroville Foundation Annual Report 2010-11, 98); Layout for the Residential Zone foreseeing a population of 5,000 people (Auroville Foundation Annual Report, 2011-12, 11); Study on affordable housing (Auroville Foundation Annual Report, 16); Plans for Green Casbah Housing project and Invocation Phase 4 (Auroville Foundation Annual Report, 16); Plans for the Pony Farm area, including Newcomer and Volunteer temporary Housing and spaces for small units (Auroville Foundation Annual Report, 2013-14, 17)

⁶¹² Auroville Foundation Annual Report, 2005-06, 24.

⁶¹³ Auroville Foundation Annual Report, 2008-09, 11.

⁶¹⁴ Auroville Foundation Annual Report 2013-14, 8.

⁶¹⁵ See, for example, ArchDaily, 2018; Auroville Design Consultants, 2023; Citadines, n.d.; Desai, 2006; Auroville Earth Institute / Realization, n.d. Architectural Review, 2023; Auroville Building Centre, n.d.; Hindu, 2013; Auroville Today, No. 340, November, 2017; Srinivasan and Venkatesh, 2011; Inscape, 2021; Architect and Interiors India, 2018.

In 2020, a housing survey was conducted across 286 residents. Taking the results to be representative, the shortages continue with limited capital for housing investment and, worryingly, rent:

Almost 50% people have a budget of only 5-10 L for the housing and all of them live with their families and thus, the built up area required and hence construction cost will be even higher. Many couples and even family people have mentioned just 1-2 L and this proves that the affordability in AV is very low. There is a striking difference between what people wish to own in AV and what they can contribute financially.

....

70% of the people can afford to pay only maximum 5k as rent and surprisingly many of them are living as couples and families and that too, with Aurovillian status. Hence, on an average, an individual's capacity to fund himself or herself in AV is drastically low.⁶¹⁶

...

If one compares the contribution people are willing to make with the average housing cost for around 100-150 sqm built up area per household, the affordability seems to be almost nil.⁶¹⁷

As a result, in March, 2021, the entry process was 'closed due to lack of housing.'⁶¹⁸ Alongside, the TDC was requested to form a subgroup with the Housing Board, FAMC, and 'other interested people who had attended the meetings' in order to implement Ayer et. al.'s 2019 suggestions. They were asked to:

... look at the multi-pronged approach required to fix the situation. The task was to remove roadblock to the implementation of housing projects and not to only look at previously considered projects but to consider new and creative housing solutions.⁶¹⁹

As of 2022, the problem of acute housing shortage continues – the Housing Service notes that:

To meet the urgent housing needs for Newcomers and Aurovilians alike, the Housing Service will need to expand its development branch significantly and strengthen its capacities for fundraising. As there is currently a housing shortage in Auroville, it may be difficult for Newcomers, particularly those with families, to find a suitable place to stay. Auroville cannot yet afford to build houses for all those joining, and one should therefore come prepared to live in a temporary home, and if possible, to pay for the construction of an apartment or house.⁶²⁰

Given this overview, we now identify governance concerns and development priorities.

⁶¹⁶ This confirms the discussion in Part III.F on structural concerns with the economic sustainability of Auroville's commercial sector. The renting capacity requires further examination if external borrowing is used to construct newcomer housing, as many have suggested and we too propose below.

⁶¹⁷ Housing Survey, 2020, 27-8, 31.

⁶¹⁸ News and Notes, No. 872, 2021, 5.

⁶¹⁹ News and Notes, No. 872, 2021, 5.

⁶²⁰ Housing Service, 2022.

vii. Challenges and Development Priorities

Three kinds of concerns emerge from our overview: (a) governance concerns, pertaining to decision-making and execution; (b) social and mindset concerns, pertaining to increased densification, sprawl and social cohesion; and (c) growth concerns, pertaining to action strategies to build housing stock and data collection mechanisms for evidence-led allocation, planning and review.

a. Governance Concerns

Our overview reflects (i) a clarity of vision in relation to the objectives and nature of development, (ii) abundant attempts to draft plans for an integrated implementation of the vision and (iii) an awareness of organizational reforms and holistic growth strategies needed to accelerate development. This is evident through the years (from the mid-1960s) in the clear definition of the urban form (housing typologies, densities and their distribution across neighbourhoods) and also in the prioritization of economic growth and social consolidation since the mid-2000s to catalyse sustainable and well-rounded housing development in Auroville. Despite these attempts, the realization of planned and phased development has been the primary concern, resulting in a housing shortage today. The first challenge appears to be the inability to reach a collective consensus on a housing development plan, a legislative concern; the second appears to be an executive concern, with an unclear identification of planning and implementation powers between the Working Groups. We briefly reflect on each.

The following points may be noted in the context of the legislative domain of the Residents' Assembly:

- a. Legislative – executive distinction:* as we discuss in Part IV.B, the legislative task of approving policy lies within the domain of the Residents' Assembly, yet the drafting and execution of plans to develop and manage housing in Auroville lies within the executive mandate of the Working Groups. Referring plans for expansion back to the Assembly is neither efficient nor as a matter of principle, necessary. It appears that an unclear implementation mandate (in practice) for the Working Groups has led to accountability concerns.
- b. Centralization and Zonal Assemblies:* as we propose in Part IV.B, Auroville may consider instituting Zonal Assemblies for each Zone, with representatives selected to a smaller Residents' Assembly – this may permit effective and more direct participation in the smaller Zonal assemblies, with city-wide concerns being raised at the Residents' Assembly. In principle, the housing policy for Residential Zone then only requires the approval of the Residential Zone Assembly. Even here, the execution of the policy, by preparing and implementing a Detailed Development Plan (with Feduchi, 2014 as the template, or otherwise) in a time-bound manner lies with the Zonal Group (the executive arm of the Zonal Assembly) and relevant Working Groups, not the Assembly. We also propose in Part IV a strengthening of the zonal and sub-zonal architecture, for efficiency and cultural reasons, with a definition of the Residential Zone into neighbourhoods, wards and sectors, with each sector having one selected, not elected, member on the Residential Zonal Group for effective coordination. This is necessary to

localize decision-making, to allow for meaningful and accountable participation. This Group serves as the community interface with the Housing Board – with an independent, empowered mandated under our proposal, hived off from the FAMC, with one member (the Chair) as *ex officio* in the Housing Board. This structure will allow for effective participation at a small-scale closer to the ground, clear executive pathways to implement with accountability and generate a sub-zonal cultural setup necessary for social cohesion and interchange, the ‘organic entities’ Anger spoke of in 1968.

- c. *Altered incentive structures:* as Ayer et. al. suggest, and our interviews confirm, the incentive structures to build and densify appear to be weak, which is reflected in the selection of members to Working Groups. To address this, as we suggest in Part IV, the selection to the TDC / FAMC / Housing Group can be through an expert-led, expert-constituted process rather than the current arrangement of a popular vote under the 2022 Participatory Working Group and their Selection Guidelines. We suggest robust sub-zonal (neighbourhood, ward and sector level) consultation mechanisms to arrive at devolved planning aspiring realistically to consensus in these smaller-groupings (‘communities of participation’), rather than large-zone-wise ones; yet with final decision making in cases of unresolvable disagreement or unreasonable delays – two key concerns – lying with the Working Group and in defined cases, the Unity Committee and Steering Group. This is to address the balance, on one hand, between participatory and technical inputs equally necessary for effective planning, and on the other, the aspiration for consensus and authoritative decision-making mechanisms. This may ensure both timely and inclusive development along the principle of ‘illuminated hierarchies with collective discipline’, Mother’s organizational suggestion. This model will naturally require further detailing, yet may serve to allow for meaningful engagement and co-production of the residential environment with those who live in that area, yet avoid the aspiration for consensus translating into a veto.

In relation to the executive mandate of the Working Groups, the following points may be considered:

- a. *Streamlining the organizational architecture:* in organizational terms, the Housing Service, a sub-group of the FAMC is the nodal agency tasked with building, repairing and renovating residences. Alongside, the Housing Board, Housing Development Trust and Housing Development Services have or continue to occupy organizational roles, with the Housing Corpus Fund created in 2005-06 (yet with little reporting in the annual plans and reports since) ‘to examine various aspects of collective housing projects for Auroville such as fund raising, creating a revolving fund, and aspects of taking external loans.’⁶²¹ In general, the records are unclear as to the specific roles and functions of each body. The second major vertical that responds to the housing is the TDC, tasked with urban infrastructure development. At various points, the following bodies are

⁶²¹ Auroville Foundation Annual Report, 2005-6.

referred to in relation to housing development: TDC, FAMC, Housing Service / Board / Development Trust and sectoral bodies for zonal development (SAIIER, International Zone Group, Residential Zone Group and ABC / ABS in particular). Despite varied experiments in consultative, community and experts-led processes that have arrived at common ground on the need to secure financing and planned development to augment housing capacity, authority to plan and implement seems undefined. For example, Housing Service indicated that they ‘hope they [the development priorities identified in Ayer et. al. 2019] are implemented’, yet it is unclear as to why the Housing Board / Service is not empowered to implement. In general, as we suggest in Part IV.C, the large mandates of the TDC and FAMC, with varied sub-groups, require restructuring to arrive at streamlined and defined executive powers with identified competences in relation to the domain. The 2016 FAMC mandate requires it to develop assets and ensure collective provisioning of housing, whilst the 2017 TDC-TOR tasks it with the drafting and implementation of Detailed Development Plans, including building approvals as against TDC-approved urban designs. This overlap between the two mandates, with the Housing Board / Service placed uncertainly in the middle, may require streamlining. To this end, we suggest the constitution of an *independent* Housing Board / Working Group (sub-divided into Planning, Implementation / Evaluation, Repairs / Maintenance tracks) empowered to lead housing development in Auroville, with restructured and streamlined mandates for the TDC and FAMC as we discuss in Part IV.C. Naturally, there are overlaps, which may be served by an *ex officio* member of the TDC / FAMC on the Housing Board for effective coordination. As a priority task, which requires domain expertise, housing development necessitates a dedicated organizational anchor.

- b. *Linking power to accountability*: so constituted, the selection of the Housing Board by an expert-led process as outlined in Part IV.C can be against defined competencies and contingent on the submission of an agreed-upon Work Plan formulated at the selection stage in consultation with the sub-zonal groups (with time-bound performance benchmarks) for the duration of their term as against which accountability can be ensured by the Unity Committee (‘internally’) and Steering Group (‘externally’). This was the explicit thrust of Mother’s 1968 Ford Foundation letter, which can serve as a design benchmark. The concern with altered incentive structures and intra-group disagreements resulting in ‘lame-duck’ Working Groups can thus be addressed at the selection stage.
- c. *Advisory Group*: as we suggest in Part IV.C for all Working Groups, the Housing Group may too consider constituting an external advisory group to (i) assist in planning and implementation, taking advantage of ‘external’ expertise and (ii) allow accountability by an independent reviewer, with a standard and light reporting mechanism to the Unity Committee in case of institutional concerns to resolve issues mid-term.
- d. *Zonal and sub-zonal strengthening*: as we noted above, the Masterplan, Directions for Growth and importantly, Anger’s early exchange with Mother demonstrate the need for neighbourhood, ward and sector level groupings in a firm sub-zonal confederated

institutional architecture. As we discuss in Part IV, this is necessary for three reasons: (i) to allow for effective and meaningful participation at a devolved level, given concerns with large assemblies such as the Residents' Assembly particularly at scale as Auroville grows, (ii) enhance sub-zonal 'local' accountability, (iii) to allow for efficient implementation by de-linking the need for developing in one sector on a zone-wide consensus; and (iv) the cultural importance of person-to-person contact in smaller groupings to generate a cohesive neighbourhood identity and belonging, required for a step-wise movement to the ideal of city-wide / zone-wide human unity (adapting Sri Aurobindo's discussion on this point). Achieving cohesion in smaller groupings, each interlinked, yet separate, offers a practical pathway for design thinking of the Residential Zone.

- e. *Governance Dashboard for Institutional Continuity, Data Collection and Streamlined Administration*: as we suggest in Part IV.C, a city-wide Governance and Integrated Data Management Dashboard can be considered for streamlined administration.⁶²² Interviews recorded a concern in relation to approvals processes for building, maintenance and repairs, as also insufficient data on utilization. Moreover, concerns with institutional continuity with handover processes between terms require standard archival practices for minutes, preparatory studies, survey data, work plans etc. to assist in directional growth despite change of personnel. In particular, standard and digitized data collection on the following heads may be considered to allow for evidence-led planning: housing units presently available, occupied and vacant; segmented division of housing needs and their provision; record of 'house tax' contributions with trends / demographic information to determine inequity / compliance concerns; status-updates on site approval, building approval, construction status; standard (light-form) utilization reports from stewards particularly for collective housing projects to determine vacancies etc. To the best of our understanding, the last city-wide housing survey was conducted in 2011-12, with a survey of all physical assets in 2014-15.⁶²³ To this end the following may be considered: develop a housing portal on the Governance Dashboard; an efficient price discovery mechanism for housing assets; transparent mechanism (algorithmic as far as possible, with manual exceptions) for housing applications and allocation / reallocation under the Housing Mandate, 2021 to avoid 'the buddy system' identified in Ayer et. al., 2019; survey of available housing stock; expand on the 2022 Housing Survey to determine need and contribution / rental capacity; streamline, digitize site and construction approvals / permits / NOC processes on the Dashboard with standard, self-certified and automated processes.

b. *Sprawl, Cohesion and Densification*

As we discussed above, Anger's early exchange with Mother had warned of 'falling into the trap of 'dormitory-towns', creating 'a city cold because it feels like a desert due of excessive

⁶²² See, Bibri, 2020 for a review of data-led planning. This is a key area.

⁶²³ News and Notes, No. 617, 2015, 3.

separation.’ This concern with optimal densities – both for sustainability concerns and to allow for a communally rich urban experiment to operate at scale – was central to the founding ideal. Concerns with the now entrenched sprawl in Auroville have been voiced from the 90s onwards, with the 2017 TDC-TOR advocating a ‘change ... [in] character from the existing sub-urban sprawled environment into a concentrated development which gives the feeling of living in an urban environment.’⁶²⁴ As of 2023, it appears that approximately 25% of the population resides outside the Residential Zone (and 20% outside the plan area) with leapfrogging development.

Concerns with sprawls are thoroughly examined in the urban studies literature – for impact on mobility, land use, social dynamics, building energy – with progressive urban movements experimenting with high-density collective housing, multi-scalar density mapping for planning etc.⁶²⁵ This is beyond our domain, yet for Auroville to lead the urban movement, as Mother envisioned, countering the current sprawl is necessary, alongside a robust engagement with the literature. The studies reviewed above from 2003 – 2019 offer practical pathways to that end. A positive note looking forward is that 64% of the respondents to the 2020 Housing Survey wished to live in the city, as compared to 19% and 11% in the Green Belt and outlying lands.⁶²⁶ Further work will be required, however, to acculture preferences towards collective housing. Approximately 90% of respondents ranked individual and row houses as their first choice, and only 8% preferred apartments – this does not seem to be tenable spatially (if we take the projected density distributions for Sectors 1 and 2 in the 2003 Directions for Growth Report, 2014 Land Suitability and Land Use Proposal and 2014 Feduchi DDP as between 38-40 sq. m. per person as built-up area) and at least in the short-term, financially, as the ‘the affordability seems to be almost nil’ among respondents.⁶²⁷

Yet, the concern it appears is not ideational, but executory. Arriving at optimal densities in terms of floor space (studies from the Masterplan onwards locate it at between 30-60 sq. meters) and manifesting it in relevant housing typologies (collective to individual housing) interspersed with green spaces (Green Zones / Green Corridors) has been a consistent focus of planning works since the mid-80s. However, low population densities have nonetheless resulted, with the ‘scattered dormitory town’ that Mother warned against. It appears thus that there is a resistance to increasing population densities tied to spatial justice, overcrowding and environmental concerns, linked as interviews suggested to the broader hesitance to the ‘city’. These concerns are weighty, yet a constitutive part of the urban challenge discussed in Part II. Density figures proposed in Directions for Growth, the Land Suitability and Land Use Proposal and Feduchi – the last two of which account for overcrowding and environmental concerns – provide a pathway to incremental densification that places Auroville in representative ranges consistent with its ideal to be a model city that can guide others.

In this, arriving at a Detailed Development Plan for the Residential Sector, particularly Zones 1 and 2, is an urgent requirement to prevent further sprawl / unsystematic development of housing and to signal the urban form of the Galaxy for future development. Absent a cohesive

⁶²⁴ TDC Terms of Reference, 2017, 11.

⁶²⁵ See, for example, Pafka, 2022; McFarlane, 2020; Güneralp, 2017.

⁶²⁶ Housing Survey, 2020, 15.

⁶²⁷ Housing Survey, 2020, 17, 31.

planning framework, it is likely that constructions made in the interim will be subject to avoidable disagreements over relocation / refencing in time, as indeed is already the case. In the interim, (i) approvals for the Residential Zones may be valued carefully in anticipation of these concerns, (ii) as the IDPP, 2014 suggested, building and site approvals for housing outside the plan area may be paused (unless regional development benefits are identified), with (iii) a time-bound plan for progressive shifting of residents living outside the plan area to Sectors 1 and 2, (iv) the increased densification of the Auroshilpam, Mangalam and Pony Farm locations may be considered, as a pathway to a Detailed Development Plan for the Industrial Zone; (v) leveraging funding for research-linked housing in the Cultural and International Zones discussed in Part III.E.

c. Growth Concerns

Insofar as growth of housing options is concerned, the following points may be considered. The vicious cycle of low population numbers generating insufficient surplus for housing development, further limiting population growth, is a critical structural concern that requires capital infusion through Foundation-backed housing loans to develop entry-level ready-to-move collective housing.

1. Cyclical stagnation and Over-Dependence on Grants

As the TDC Annual Development Plan and Ayer et. al. noted, housing development is tied to the strength of the commercial sector. We consider this in Part III.G in more detail, yet its impact on housing is a critical inter-sectoral link that merits attention. The City Services Fund for housing has – on average, for 2019-22 – been less than 3 lakhs for development, with expenditure largely on repairs and maintenance. This places the financial burden of housing development on three sources: (i) self-funded, which leads to entry barriers for young newcomers central to Auroville’s demographic profile and research-oriented aspiration, (ii) unit-funded, which is an option with limited potential currently due to low surplus and flat contribution rates that disincentivize housing investments, and (iii) grants and donations, which have accounted for a majority of housing-development activity. Auroville’s aspirations to the ‘prosperity’ / collective provisioning ideal – voiced in several interviews, and front-ended in the discussions at the 2015 Retreat – are thus currently funded by external moneys, which is an unsustainable and undesirable model. As a ‘model’ city, Auroville must be able to generate its own reserves to sustain housing, yet the policy-discussion has historically focussed on distributive rather than growth concerns. Insofar as housing development relies on external capital, the ‘no-money-exchange’ ideal, as we discuss in Part III.G, is in reality dependent on external monetary support. This structural concern was registered by Ayer et. al.:

As per the housing service data of the number of individuals (beds) who request housing they have been able to provide for 25%-35% with the exception of 2016 and 2018 where they could meet up to 62-63% due to GOI grants allocated for housing. The dependence on GOI grants for housing is a result of the economic policy of contribution along with the hyper risk averse regulations from the FAMC that discourages investment in enterprises or housing.⁶²⁸

⁶²⁸ Ayer et. al., 2019, 26.

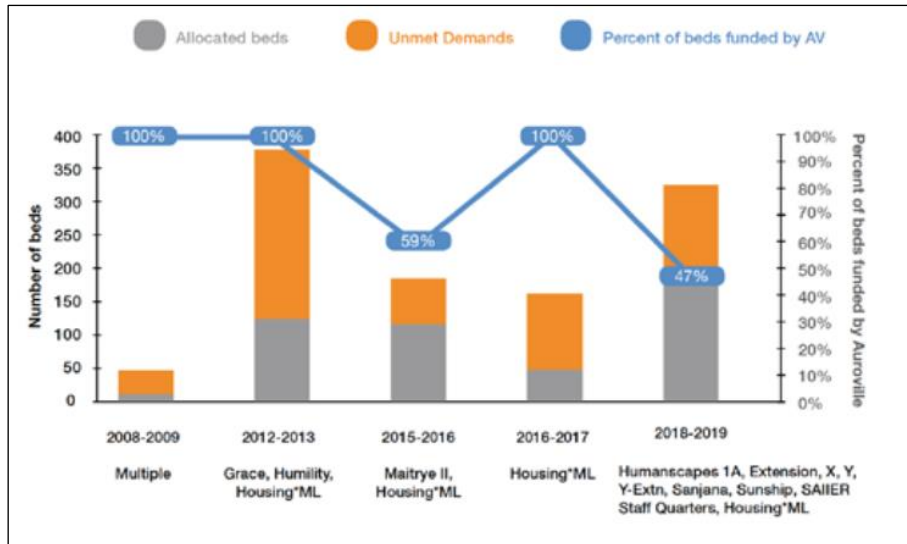

(Available beds, unmet demand and Auroville versus external contribution to housing. *Source: Ayer et. al., 2019, 26)*

Between 2011-2023, Auroville received approximately Rs. 103 crores for housing development, a large sum. To the best of our understanding, there are no standard utilization metrics by which this spending is measured – this is an institutional risk that may be accounted for by an independent monitoring and evaluation track in the Housing Group suggested above, with standard utilization and evaluation protocols automated on the Governance Dashboard.

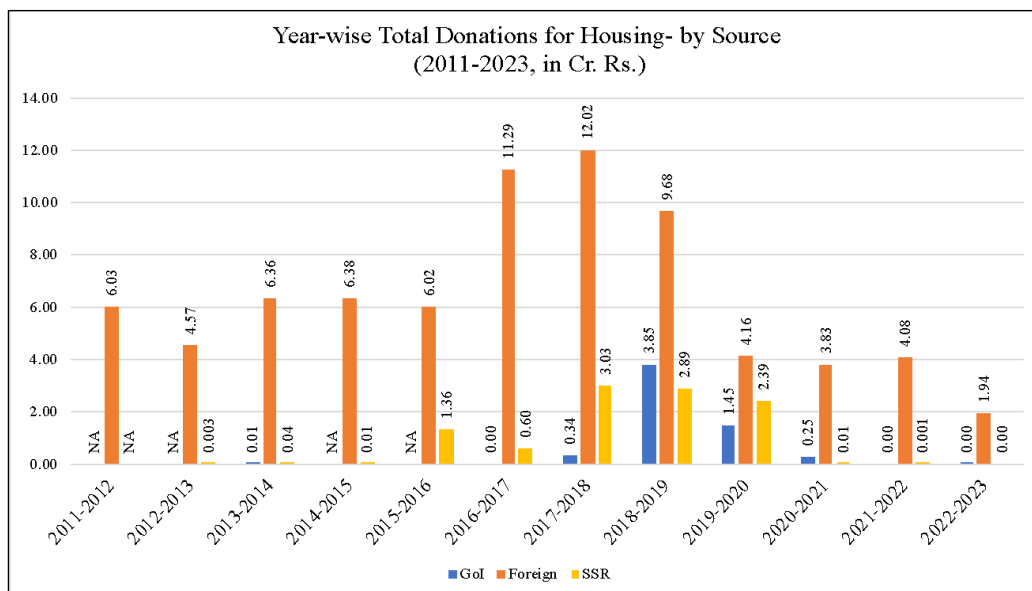

(Housing donations 2011-23. *Source: Unity Fund)*

Strategic planning to build sufficient surplus and reserves in the commercial sector is thus key for Auroville’s medium-long term housing strategy. To this end, the following actions may be considered by the Housing Group. We incorporate here suggestions made by previous studies.

2. Incentives for Investment

- i. Amend the 2017 Code of Conduct for credits / deductions for housing investment for unit executives or employees. Tie deductions to incremental addition of capacity for all new residential construction, and a percentage of lower cost units (3-4 lakhs) in all planned residential developments. Further, to encourage responsible stewardship, consider deductions for housing maintenance / repairs within specified limits.
- ii. Create a Housing Fund for contributions by residents to be invested by the Financial Services / managed by a professional body, not as an un-tied 'donation' but with secured interest / returns for future housing development. It appears that residents currently prefer to keep savings privately, rather than deposit in a housing-specific fund as the latter is treated as a donation. Whilst the legal form of 'donation' may be secured, an internal policy framework to allow withdrawals may balance these concerns, allowing in the meantime for greater liquidity for housing development.

3. Strategic Growth Options

- i. Inventory rental options in nearby villages for the short-term.
- ii. Pursue research-linked funding for housing, identified in Part III.E.
- iii. Consider feasibility of translating excess guest-house capacity into interim housing
- iv. Explore live-work housing units linked to industry-backed commercial enterprises, identified in Part III.F.
- v. Pursue low density housing options in the Green Belt in line with the New Prosperity Policy, 2023.
- vi. Finalize the proposed housing loan from HUDCO (under consideration as of June 2023) for entry-level collective housing.
- vii. Finalize the proposed housing loan from HUDCO (under consideration as of June 2023) for entry-level collective housing.
- viii. Explore funding options through private and non-profit channels such as SEWA Bank, Micro-Finance Housing Corporation, Micro Home Solutions (Delhi), DBS Affordable Home Strategy Ltd., Tata Housing.
- ix. Develop market-rate housing on lands outside the designated township identified by the LRD Task Force to be sold/rented to Friends of Auroville/Auroville employees to cover housing shortage within Auroville. Examine feasibility of private sector investment in meeting the demands of Auroville's housing needs, with long-term repayment guaranteed

by the Foundation. We address the legal, tax and regulatory concerns in respect of these proposals in Part III.F.

d. Development and Miscellaneous

- i. Time-bound preparation of a DDP for Residential Zone Sectors 1 and 2, with Feduchi, 2014 as a starting template, with amendments if necessary.
- ii. Plan and implement two acupuncture projects on the Residential Zone Crown immediately as a pathway to a time-bound Development Plan, with Kundoo, 2007, Feduchi, 2014 as templates, addressing concerns / suggestions in the Land Suitability and Land Use Proposal, 2014. Alongside, finalize a watershed management plan for the Residential Zone based on the 2013 Water Sourcing Study, with the city-wide environmental audit proposed in Part III.A, to allow for planned developments without delay.
- iii. Time-bound preparation of the DDP for the Residential Zone Line of Force, with multi-scalar density modelling to generate informed community dialogue.
- iv. Map and mark non-permanent fencing and boundaries existing currently, to ensure clarity and avoid uncertainty or conflict for future development.
- v. Define a sub-zonal (neighbourhood / ward / community level) institutional architecture, to allow for the emergence of collective identities in relation to planning decisions, with dedicated portals on the Governance Dashboard for each to allow for easy and meaningful engagement on upcoming and ongoing projects. Localize participation at the sub-zonal level, without reference to the Residents' Assembly, with authority in case of disagreement lying with the executive arm, i.e., the relevant Working Group, subject to the Unity Group for one level of checks and balances.
- vi. Develop a neighbourhood / ward-level handbook to allow newcomers to freely gravitate towards a chosen community. Entries and exits not to be subject to neighbour's approval, yet determined naturally by alignment, in line with Mother and Sri Aurobindo's suggested framework.
- vii. Reconsider the three-tiered payment structure in the New Prosperity Policy (May, 2023) in relation to existing housing stock to counter entry barriers, if newcomer is unable to afford housing. Alternatively, link monthly payment to percentage of future income stream / in-kind contribution.
- viii. Pursue research-linked housing options in the International Zone with development agencies (DFID, USAID, IDRC, Asia Foundation etc.) / satellite centres for established research-universities / foreign governments, as discussed in Part III.E.

- ix. Finalize Urban Design Guidelines, 2010; review, finalize the 2013 draft Building Guidelines by TDC / Eveleigh to regulate energy efficient construction practices.
- x. Develop a neighbourhood / ward level architectural language to ensure a cohesive aesthetic, with conscious effort to ensure diversity in approvals processes across the sector.

*

E. EDUCATION AND RESEARCH

Mother's vision for Auroville as a centre for research and study places the education and research landscape not as one vertical amongst others, but an embedded field of activity across sectors. Importantly, the spirit of unending spiritual and temporal education in the path of the Integral Yoga imbues an educational ethos across Auroville activities, such that the formal institutions we discuss in this part are only a small part of the picture. As such, the first and indeed last marker of research and education in Auroville, its *raison d'être*, is knowledge sought on the inner journey through spiritual practice, a progressively expanding experiential identification with the Divine, *para vidya*, in the vast, complex and ineffable inner terrains. This is not a routinely-identified 'developmental priority,' far less a checklist item to be captured in formal policy prescriptions, but an imperative that englobes all life and activity. Nor, we may note, is it necessarily obvious to the outward eye. It imagines a living and vibrant public culture of seeking and research, backed by a strong material infrastructure, a complex web of tangibles and intangibles that can together generate fertile ground for the individual and collective yoga. A brotherhood aspiring for the descent of Knowledge – the 'greatest sweat of knowledge upon Earth'.⁶²⁹ Few collectives come with this constitutional imprint, none at a city-scale or dedicated to the synthetic and terrestrial vision of the Integral Yoga: 'the creation of a city like Auroville has more weight in the earth's history than all the groups of the world.'⁶³⁰ Needless to say, this anticipates a singularly important advance in knowledge systems, pregnant with yet to be imagined possibilities for research and practice. Our discussion here is far more modest, to examine the more tangible and quantifiable works within immediate reach that can set the foundations for this enterprise. Naturally, Auroville's spiritual and research imperative cannot be contained in formal governance mechanisms or institutional architectures, which are our concern in this short study, though they may facilitate it. The causality runs the other way: 'A mystic Form enveloped his earthly shape.'⁶³¹

As we outlined in Part II.B, Sri Aurobindo's 'System for National Education', 'Brain of India', and the 'free progress' system detailed in Mother's 'On Education', practiced in their lifetimes in National College, Calcutta and later the Sri Aurobindo International Centre of Education, Pondicherry, provide practical guidance for Auroville's own systems design.⁶³² Even here, a complete review of their educational thought or Auroville's education and research landscape is beyond our purview. Rather, we offer a thematic summary of developments, with suggestions for future development. A comprehensive detailing out of proposals were not possible in the time constraint, and as such, will require further work if they are taken up.

i. *The Early Years*

The early 'Aspiration' community developed Auroville's first foray in education, both for local youth and the children of the first residents: 'schools' were set up in homes, *keet* and thatched

⁶²⁹ Guigan, 2018, Vol. 1, 45.

⁶³⁰ Guigan, 2018, Vol. 1, 215.

⁶³¹ Sri Aurobindo, CWSA, 1997, Vols. 33-34, 334.

⁶³² Mother, CWM, 2002, Vol. 12; *see*, Joshi, 2001, and his other works, for an exposition on the free progress method.

structures to bring to life Mother's 'free progress' system as adapted to the realities of the time. As land to build Auroville was being acquired in parcels and was not yet consolidated, schools and Aurovilians were scattered across varied places between Pondicherry (near the Sri Aurobindo Ashram) and in early communities such as Aspiration (outside the now known boundaries of the designated township). Schooling was experimental in that it did not rely on the standard instruction-based formats of assessment and teaching – literature from the time records early experiments in facilitated learning with teachers acting as guides and building on children's own explorations and mutual learning in a loosely organized multi-cultural setting.⁶³³ Indeed, complaints were made to the Mother at the time, but she refused to intervene, allowing space for the experiments to evolve on their own terms:

An incident worth noting is that in 1972 there were parents who complained to Mother that their children were not being educated properly, which meant they were not learning to read and write and they were not good in general studies and they were not equipped for life, etc., and the Mother replied to them, 'if the parents are not satisfied with the education being given in school, they may take their children elsewhere'. In many ways Mother made it clear that she was supporting the experiments being made by the teachers in the school.⁶³⁴

Some such early schools to be started at the time included Equals One (=1) in Pondicherry, the Aspiration school, Last School, Sanskrit School, La Ferme, Pyramids, and a Kindergarten – Aggarwal and Watts, early pioneers in Auroville's education landscape, present a rich history of Auroville schools from 1968-1984, remarkable for the intensity and creativity of work at the time despite serious resource constraints.⁶³⁵ This presents fertile ground for historical research given limited, published material on the area.⁶³⁶ Watts, for example, notes:

The 70s were a rocky time for education in Auroville as different educational philosophies and (sic) attitude toward school became a magnet for other conflicts within Auroville, but after a period of no schools, small and varied experiments in schooling began to crystallize into coherent programs, many radiating from Centre Field where the original creche and kindergarten remain. At first a school might be just a parent with a few children, but these small experiments soon became clusters of schools based on the language of the children: French, English or Tamil. In 1984, these embryonic schools moved to where Transition School is now and became one school for children of 1st to 8th standard, with English as the main language.⁶³⁷

Agarwal narrates early experiments, indicative as in the other sectors at the time of enthusiasm and enterprise:

The history of Auroville schools begins with a school started by Yvonne Artaud called = 1 (Equals one). This was sometime in the late 1960s. The school was located in Pondicherry and children of people accepted to be in Auroville went to that school. The school was highly experimental in nature; had a very high teacher-student ratio;

⁶³³ See, Aggarwal, 2011.

⁶³⁴ Agarwal, 2011, quoted in Thomas and Thomas, 2013, 76.

⁶³⁵ See, Aggarwal, 2011; Watts, 2005; Watts, 2018.

⁶³⁶ Sri Aurobindo Institute of International Education Research, 2018 contains some insightful accounts. See also, Majumdar, 2017, 132-151 for short narratives from the time and the later institutionalization, pointing to an important tension to consider as Auroville matures.

⁶³⁷ Sri Aurobindo Institute of International Education Research, 2018, 10.

but was not acceptable as a model for Auroville. It lasted till about 1974 and then closed.

Next was a school in Aspiration, sometime early in 1970, run by Ursula with assistance by Rod Hemsell ... A large keet hut was put up in Aspiration - one of the early communities. A bus would come from Pondicherry and ... reach the school collecting children from various families of Aurovilians on the way. The school started with about 35 children. In 1973 it had expanded to include 105 children representing 10 different nationalities, 9 Indian states and a wide diversity of social and cultural backgrounds.

The teachers tried to rely solely on the aspiration and enthusiasm of every individual involved and on the mutual stimulation and direction that had arisen naturally among them under such diverse and harmonious conditions, as they were freed from conventional demands and were guided and inspired by the highest educational ideals. There were no examinations or imposed standards to be met. The groupings of students and teachers were not made arbitrarily. The children were encouraged to learn for the joy of learning and were free to move from one area of interest to another as they wished. The aim of the school was a full and natural integration of the children into the life of the community, where they would find their place by following their own natural interests and aptitudes.

By 1973, the school was well settled and had a well running programme. It was spread over a very wide area. The Library was placed in Last school. La Ferme, which was called 'Mango Grove' at that time, which is on the other side of the canyon from Aspiration, was part of the school. Then in Aspiration various buildings like Last School and Sanskrit School and even the Pyramids though incomplete were being used as labs where children could work independently. The Kindergarten was also located in Aspiration. There was a Tibetan boarding house in what is now Protection, a community kitchen in Douceur, and the sports ground, which was where the Shakti community is now.⁶³⁸

There was, at the time, a healthy exchange between the Sri Aurobindo International Centre of Education at the Sri Aurobindo Ashram and the early education experiments in Auroville. With Mother's passing, and rising tensions with the Sri Aurobindo Society, records indicate that this hitherto collaborative model was disrupted (i.e., only students and teachers residing in Auroville were allowed to be part of the Auroville education system).⁶³⁹ Whilst this fissure – with connections severed till date – had a developmental impact on the youth, learning was kept alive in small groups in existing structures in Aspiration, homes and in temporary structures around the Centre Field, Certitude, Kottakarai areas driven by demands from parents and the passion for education development in the early pioneers.⁶⁴⁰ Agarwal recounts:

After Mother left her body in November 1973, from about June 1974 onwards difficulties between Auroville and the Sri Aurobindo Society started. In the initial period, the school was not quite affected. It was sometime in November 1976 that a

⁶³⁸ Thomas and Thomas, 2013, 75-8.

⁶³⁹ Thomas and Thomas, 2013, 76-7 ('... in November 1976 a clear choice was placed before students and teachers that only those who lived in Auroville could be the teachers or students at the school ... as all teachers and students from Pondicherry were no longer welcome.')

⁶⁴⁰ See, for example, Watts, 2003; Sraddhavan, Sri Aurobindo Institute of International Education Research, 2018.

clear choice was placed before students and teachers that only those who lived in Auroville could be the teachers or students at the school, and suddenly this was the end of the school, as all the teachers and students from Pondicherry were no longer welcome. A number of Auroville teachers then created a small study space for children in and around their own homes. Also there was no longer any bus to move the children to school. The parents of the Centre area - Certitude, Centre Field, Kottakarai - felt the need for a school. Diane Hassinger built a large keet structure in the Centre Field area and offered it to the school sometime in 1978-79, where now the Kindergarten is located, and what came to be known as Centre School grew there in 1979. Mauna took charge of the school and built it further into a flourishing school.⁶⁴¹

Simultaneously, the early years also witnessed a significant thrust in educational activities for the 'first citizens of Auroville' i.e., for locals in the surrounding villages notably in Morattandi and Edayanchavadi. Led by Vardarajan-Syamala and Nata, chosen by the Mother for the work, a Kindergarten was set up along with special classes for local children in Tamil (which later led to the formation of the Arulvazhi and Udavi schools). With these formative developments, the broader task at hand – to develop integral educational and welfare schemes for the region, classified at the time as a 'most backward area' – emerged in sharp relief. The early records indicate a complex set of individual initiatives grappling with problems of nutrition, cleanliness and the lack of basic civic amenities which had to be addressed for any meaningful learning to flourish in the bioregion. The enterprise of pioneers in the field, up against difficult odds, is well documented.⁶⁴² As educational activities in surrounding villages in the early years grew, they evolved into Auroville's larger and, as of today, noteworthy project of integrated rural regional development. We discuss these outreach activities in Part III.H.

ii. Consolidation post 1984 for Systematic Expansion

With the passage of the 1980 'temporary takeover', leading to the Auroville Foundation Act in 1988, the new administrative setup introduced a much-needed channel of funds and an opportunity to consolidate early educational activities into an institutional structure. Government grants began to be released under the 'Auroville Development Scheme' (1985-1999) to catalyze city-building through multi-sectoral development. Education emerged as a priority sector for the national government at the time, as the then Prime Minister, sought to set up a Central University in the memory of Sri Aurobindo in Pondicherry. Following this, on the proposal by the then Chairman of the Auroville Foundation Professor Joshi, the Sri Aurobindo International Institute of Education Research ('SAIIER') was founded in Auroville in 1984. SAIIER was envisioned as an umbrella organization to coordinate and support capacity building and educational and research experiments being undertaken by existing and emerging schools in Auroville and nearby villages. Government aid thus began to flow into SAIIER under the national 'Scheme of Assistance to the Institutions of Higher Learning of All India Importance', beginning 1984 through 2002.

⁶⁴¹ Thomas and Thomas, 2013, 76-8.

⁶⁴² See, Aggarwal, 2011.

The infusion of government funds into Auroville sparked the phase of semi-planned development in the education sector.⁶⁴³ Early attempts at sector planning are reflected in the Auroville Development Scheme, 1988-1995, and SAIER's five-year plans 1997-2002, 2002-2007 and 2007-2012.⁶⁴⁴ Between 1984-2012, the plans exhibited a two-fold focus: (i) building and strengthening pedagogy (along four areas viz. a new education (teacher-pupil relations, methods of assessment etc.), developing learning materials and a new syllabus, furthering research and promoting outreach) and (ii) infrastructure development (construction and upgradation of school campuses). We briefly consider these early development schemes and plans to understand the historical trajectory of the organization of Auroville's educational landscape, which continues to define debates today.

In relation to the first Development Plan, 1988-90, the focus was on developing infrastructure. The plan addresses five areas (i.e., research in value-education and scientific enquiry, evolving methods of learning, formulating learning materials and a new syllabus and promoting outreach) that continue to define the outlook, at times reproduced *verbatim*, in the consequent plans for SAIER post 1988 till date. The early emphasis on strengthening educational infrastructure came with a strategic focus to build housing and civic infrastructure alongside the schools, early indication of education being envisioned as a key driver in growth strategies. This policy of strategic building of educational capacity seems to be implicitly reversed in subsequent years. Funding, whilst increased, was still limited at this time – a request for Rs. 2.52 crores was made for the 7th Five Year Plan, with only Rs. 35.55 lakhs sanctioned. The sector thus had 'to curtail seriously our plans of expenditure to fit the new budget. It means that we had to make a drastic selection, in which among other things a lot of very valuable equipment was cut out.'⁶⁴⁵

The second Development Plan from 1990-95 similarly prioritizes infrastructure development – it proposed 11 buildings, including two campuses (Last School and Transition School), hostels and staff quarters, a central administrative building, yet undetailed out Centres for Research and Rural Learning Centres, along with the CIRHU campus and sports facilities.

The third Development Plan from 1997-2002 demonstrates a relatively greater focus on strengthening internal institutions and defining the pedagogy and practice of education in Auroville schools. The growth trajectory between 1996 and 2001 is significant, both in infrastructure and pedagogical terms, in schooling (despite resource constraints), yet little movement is recorded in the tertiary research or higher education sectors, with limited discussion on students' choices post-graduation from high school, particularly in professional fields. This is with the exception of the Centre for International Research in Human Unity ('CIRHU'), first proposed by Anger in 1988, which figured prominently in the early proposals but without any movement. As a response, in 2000-2001, the Centre for Further Learning – currently not in operation, as far as we are aware – was established to provide an avenue for

⁶⁴³ Thomas and Thomas, 2013, 74-8.

⁶⁴⁴ Auroville Development Scheme: 1988-1995; Sri Aurobindo Institute of International Educational Research, 1997-2002; 2002-2007; 2007-2012.

⁶⁴⁵ Scheme for the Development of Auroville, 1987.

‘those who wish to pass traditional exams, receive certification, or go abroad’ post-school.⁶⁴⁶ Interestingly, grants coming in at the time supported Auroville’s schooling not *qua* educational subsidies, but as educational research – SAIER was to contribute to India’s educational landscape with experiments made possible by these subsidies. This outward-looking focus gradually dims in subsequent years. In a rough summary, the development agenda focuses on ten areas:

- i. Facilitative learning experiments, to develop a pedagogy that encourages free progress and child-centered learning, rather than an instructional teacher-pupil relationship – to nurture the teacher’s role as an ‘animator’ and ‘observer’, rather than as a lecturer; with a focus to translate these experiments into a K-12 syllabus, with learning materials, as a practical complement to Mother’s ‘On Education’.
- ii. Research on re-design of the physical structure of the classroom, seating arrangements etc. to generate an aesthetically supportive environment for learning.
- iii. A focus on language training, particularly for learning in multi-lingual groups.
- iv. Re-thinking methods of assessment, for self-directed learning and evaluation in line with Sri Aurobindo’s ‘third principle’ of education – experiments are recorded to move away from a marks-based examination system towards self-assessment, portfolio of sample works, observations by teachers and parents.
- v. Encouraging creative expression, with an emphasis on the fine arts and performing arts, and a focus on physical education research.
- vi. Building manual skills, to integrate classroom and experiential methods, with mentorship/apprenticeship models embedded in the community.
- vii. Creation of platforms for knowledge exchange and future planning, to hold national conferences and collaborate with other institutes such as the National Council of Educational Research and Training, Indian Council of Philosophical Research etc.
- viii. Encourage publications to document pedagogical research, with two interesting volumes successfully published, *The Aim of Life* and *The Good Teacher and the Good Pupil*,⁶⁴⁷ both edited by Professor Joshi.
- ix. A focus on outreach, to share learnings from experiments in educational research in Auroville with the world through teacher’s trainings (with programmes for interested teachers outside Auroville in value-oriented education, assistantships with Auroville teachers, apprenticeship for youth interested in pursuing a teaching career and monthly workshops for teachers in nearby villages)

⁶⁴⁶ Sri Aurobindo Institute of International Educational Research Annual Report, 2001-2.

⁶⁴⁷ Joshi (ed.), 1986; Joshi (ed.), 1988.

- x. A push on mass media (documentaries, short-films, films, audio-books etc.) to document and promote the educational system in Auroville.

At this time, detailed proposals were also drawn up for the Educational Sector Loop in the Cultural Zone, meant to serve as a closely-knit, cohesive concentration of schools and research centres in proximity. This is a critical and urgent design element for schooling in Auroville, with great promise and possibility to develop a beautiful and lively learning *community*, which we briefly reflect on below. Interestingly, Mother indicated that this Zone was an embodiment of her aspect of *mahalakshmi*, which yields to a harmonious and beautiful arrangement of the physical – in the educational loop as elsewhere – in the ‘unity and ... glad flow of many lives’, of children, teachers and researchers:

Harmony and beauty of the mind and soul, harmony and beauty of the thoughts and feelings, harmony and beauty in every outward act and movement, harmony and beauty of the life and surroundings, this is the demand of Mahalakshmi. Where there is affinity to the rhythms of the secret world-bliss and response to the call of the All-Beautiful and concord and unity and the glad flow of many lives turned towards the Divine, in that atmosphere she consents to abide ...⁶⁴⁸

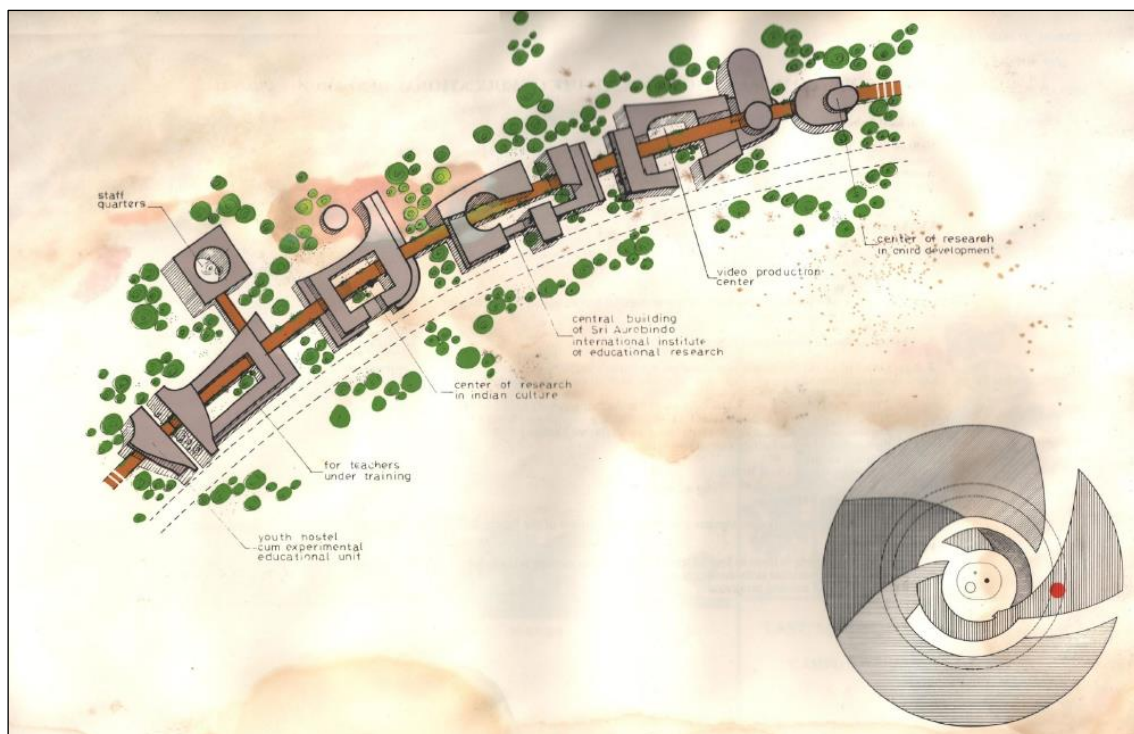

(Plan for SAIER-Phase II (1990), Source: Auroville Development Scheme 1988-1995)

These were not, as far as the records indicate, developed further at the time given resource constraints, nor subsequently. The 2014 Land Suitability and Land Use proposal notes that the

⁶⁴⁸ Sri Aurobindo, CWSA, 1997, Vol. 30-32, 20, 574.

detailing of this plan is yet to be done – the reasons for this delay seem to relate to broader concerns with unsystematic city-planning, slow population growth rate that renders expansion unnecessary and the relative insulation of schools, teachers and SAIER from each other.

Thus, between 1997-2002, substantial work was done to develop six active primary and secondary schools (two creches, a kindergarten, Transition, Mirramukhi and Last School) and six active schools in the surrounding villages (New Creation, Ilaignarkal, Isaiambalam, Arulvazhi, Life Education Centre and several Evening Schools).⁶⁴⁹ The education spending increased accordingly from 92.8 lakhs in 1995-96 to 544.87 lakhs in 2001-2002. However, annual government grants to SAIER registered a decline post 1995, in the absence of any formal assessment of its financial requirements in that period. As a result, Auroville Today reports in 2001:

In December 2000 the Auroville School Board, the working group that coordinates the work of all the Auroville schools, sounded the alarm. It announced that, from January 2001 onwards, there would be a severe shortfall of funds. It also announced that there would be problems admitting new students to the kindergarten creche and to Transition primary school as some classes are full. In addition, a shortage of teachers prevents Deepanam creche and primary school taking more children.⁶⁵⁰

iii. The Pande Visiting Committee

In response, in March 2002, SAIER submitted a detailed funding proposal to the Department of Higher Education, Government of India: this Development Proposal for 2002-2007 was in relation to the 10th Five Year Plan ('Plan Grant Proposal') and presented a roadmap for Auroville's educational sector. Subsequently, a Visiting Committee was appointed to evaluate this proposal. This Plan Grant Proposal and the Visiting Committee Report merit attention, as they represent the comprehensive action plan for Auroville's education sector:

First, institution of tertiary research faculties: the Plan Grant Proposal envisaged the development of seven Research Faculties, namely, the Faculty of Education for Human Unity, Faculty of Studies in Sri Aurobindo and the Mother, Faculty of East, West and Human Unity, Faculty of Indian Culture and Human Unity, Faculty of Humanity, Nature and Development, Faculty of Perfection of Human Body and the Faculty of Arts, Crafts and Technology. A substantial budget outlay of Rs. 29.26 crores was proposed for these faculties, indicating a major push to develop a research infrastructure. The Report quotes General Chatterjee, the then-head of SAIER, in relation to SAIER's plans to 'grow into a world-class institute', detailing 'how the entire setting of Auroville provides a fitting environment and also the required personnel in the form of researchers, educationists, thinkers, philosophers, scientists, sociologists and specialists ...'⁶⁵¹ The proposal also included the development of an 'Apex Body', the Centre of International Research in Human Unity ('CIHRU'), which would aim at convergence for researchers within SAIER and around the world who are engaged in the theme

⁶⁴⁹ See, Sri Aurobindo Institute of International Educational Research Annual Reports, 1997-98; 1998-99; 1999-2000; 2000-1.

⁶⁵⁰ Auroville Today, February, 2001, 2.

⁶⁵¹ Report of the Visiting Committee, 2001, 7.

of human unity.⁶⁵² In relation to CIHRU, the Report noted that ‘there is a great potentiality, what is immediately needed is minimum constructed space and required equipment.’⁶⁵³ Below is a reconstruction of the faculties proposed, that may serve today as a useful template for the tertiary university to be developed in Auroville:

Faculty	Proposed output criteria (2002-2007)	Proposed Faculty contribution
Faculty of Education for Human Unity	Research	Developing tertiary educational institutes beyond the Last School in line with the Mother’s vision, including After School, Super School, and a sports infrastructure.
	Teaching/learning materials development	Promoting publications on themes of value education (in cooperation with the Indian Council of Philosophical Research), producing translations of existing work for better reach (e.g., The Good Teacher and the Good Pupil / Aim of Life) through the Centre of Research in Communication and Publications and Aurofilm, to produce audiovisual materials.
	Teacher training	Strengthening the theory and practice of integral education through two dedicated bodies, the Centre of Research in Teacher Training and the Auroville Educational Resource Centre.
	Outreach	Meeting the educational needs of children and working adults in surrounding villages through the Tamil Ulagam for non-formal education, village libraries and village school (Arulvazhi, Ilaingarkal, Isaiambalam etc.)
Faculty of Studies in Sri Aurobindo and the Mother	Research	Promote and facilitate research on the teachings of Sri Aurobindo and Mother through Savitri Bhavan and the House of Mother’s Agenda.
	Teaching/learning materials development	Develop courses and study aids on Sri Aurobindo and the Mother’s major works.
Faculty of Indian Culture and Human Unity	Research/Training/Learning Material/Outreach	Develop four centres dedicated to exploring multi-cultural Indian Heritage and Indian Arts, namely the Centre for Research in Indian Culture, the Centre of Indian Studies, Kala Kendra and the Tamil Heritage Centre.

⁶⁵² Report of the Visiting Committee, 2001, 1-2.

⁶⁵³ Report of the Visiting Committee, 2001, 34.

Faculty	Proposed output criteria (2002-2007)	Proposed Faculty contribution
Faculty of East, West and Human Unity	Research/Training/Learning Material/Outreach	Promote multi-cultural knowledge exchange and research the Unity Pavilion (to act as a 'seed and catalyst for the development of the International Zone in Auroville'), the Language Learning Centre, to promote basic literacy in Tamil, French, Sanskrit and English along with other languages and the International Information Centre.
Faculty of Humanity, Nature and Development	Research/Training/Learning Material/Outreach	Four institutions are proposed for ecological research, namely the Auroville Institute of Botanical and Ecological Studies, the Ecological Agriculture Research and Extension Centre, the Centre for Applied Research in Integrated Human Settlement Development, the Coastal Water Research Institute and the Children's Pony Farm.
Faculty of Arts, Crafts and Technology	Research/Training/Learning Material/Outreach	Three institutions are proposed in this vertical, namely the Centre of Research in Performing Arts, the Centre of Research in Visual Arts and the Centre of Training in Technology/ Technology Resource Centre. In addition, proposals are made for the development of training programmes in pottery and the development of vocational training programmes in crafts.
Faculty of Perfection of the Human Body	Research/Training/Learning Material/Outreach	Four institutions are proposed for medical and health research, namely the Centre of Integral Medicine, the Dental Research and Training Centre, the Surya Mukhi-Martial Art Centre, the Naad Brahma Scientific Resonance Research Centre and the development of programmes for physical fitness in villages and other parts of India.

Second, developing forms of embedded education: the Plan Grant Proposal suggests an embedded educational setup, with schools integrated in the various sectors of work in the city:

[it] was pointed out that the guiding principle of educational research is that all life is education and that when life is fully organized, every aspect provides to each student the right stimulus and appropriate teaching-learning material required for the student's growth and development ... That being the aim, it was explained, schooling processes should give way gradually to reaching a stage where no schooling is

needed, since all the necessary educational experience is gained from the educational environment and atmosphere of the total life organized around the students and the teachers.⁶⁵⁴

This is an important ideal for Auroville to experiment and develop today, both to translate Mother's vision of unending education into institutional form and to leverage the city-environment that is uniquely suited to anchor such a model. As we discuss below, Auroville's experiments here have great potential for collectives elsewhere.

Third, contribution to educational setups outside Auroville: the Visiting Committee Report notes that SAIER aims to make 'a major contribution to the world of education', with an 'experimental syllabus with regard to value-oriented education [that] ... can be adapted in any school programme ...';⁶⁵⁵ equally, it recognizes Prof. Joshi's *The Good Teacher and the Good Pupil*, which 'has ... been evaluated by NCERT, and the Ministry of Human Resource Development has even recommended that this book should be made available to every teacher in the country.'⁶⁵⁶ Further, the Report indicates that Auroville is to lead curriculum development for teacher training and value-oriented education to service the educational needs of India. In particular, it is worth noting that the Plan Grant Proposal included a draft curriculum for Value-Oriented Education (Class I to XII), a draft curriculum for a Bachelor of Arts in Applied Philosophy, a draft curriculum for Value-Oriented Education Under the Teacher Training Programme, and outlines for further work in this area, through the two proposed projects, 'Experimental Research in Education for Development of Integral Personality' and 'Explorations in Contents and Methods of Last School, After School, Super School, No School.' In this respect, the Report noted that they are 'impressed by the fact that the Institute aims at developing two additional syllabi, one for education for human unity, and another for scientific study of the world. Considering that the present syllabi of the country and the world insist too much on stuffing the mind with and more information ...'.⁶⁵⁷ They also indicate that they are 'greatly inclined to support the Institute's idea of developing laboratories.'⁶⁵⁸ Records indicate that these 'learning labs' came up in a limited way, with most experiments fading away in time. As we discuss below, they can be revived and expanded.

Fourth, recognition of early work in line with the National Education Policy, 1986: the Report concludes with a recognition of the early pioneering work done in the sector:

... the work of SAIER is also based upon the answers that we found to various questions relating to the relevance and significance of the work of the SAIER in the context of the National Education Policy (NEP) (1986) ... The work of SAIER is found by us to be in consonance with these concerns ... SAIER can be perceived as one of the rare institutions working centrally on the tasks of education ... This is a rare achievement, and it deserves to be continuously encouraged and supported.⁶⁵⁹

⁶⁵⁴ Report of the Visiting Committee, 2001, 11.

⁶⁵⁵ Report of the Visiting Committee, 2001, 12-14.

⁶⁵⁶ Report of the Visiting Committee, 2001, 15.

⁶⁵⁷ Report of the Visiting Committee, 2001, 36-7.

⁶⁵⁸ Report of the Visiting Committee, 2001, 36-7.

⁶⁵⁹ Report of the Visiting Committee, 2001, 31-3.

The Report further notes that SAIER's work can plug a gap in the country's education system, tying funding to the value that Auroville's schools can add elsewhere:

... research in contents and methods ... is in consonance with India's urgent needs of educational development ... the country ... does not yet have any satisfactory curriculum which can implement and foster value-oriented education, integral education, and education for human unity ... It can be said that SAIER has progressed considerably in this direction, and what SAIER has done can be rated as rather very precious.⁶⁶⁰

Notably, the Report recognized that the work in Auroville had humble beginnings, led by committed residents despite severe resource-constraints:

we have witnessed that activities in this Institute have outstripped the facilities available to them in terms of building and equipment ... During all these years since inception, the Institute has not asked for any assistance for construction of buildings ...⁶⁶¹

With the passage of the New Education Policy in 2022, a review of Auroville's schooling sector – to reflect on movements since the 2001 Visiting Committee Report and plan ahead to channelize the headwinds generated by the new policy – is a useful exercise to conduct today. This is both to evaluate progress as against benchmarks in the Plan Grant Proposal and to leverage work to assist schools elsewhere, an important yet forgotten component of SAIER's founding principle.

Sixth, focus on publication: responding to the Plan Grant Proposal's push on publication (a lacuna in Auroville's educational sector today, as we discuss below), the Report noted that when SAIER's 'programme of publication which are now envisaged will be completed, the country will have a very rich treasure of resource materials from which new kinds of books will be made available to millions of students and teachers of the country'.⁶⁶² This outward-facing avatar of SAIER has since taken a backseat, with limited research publications, curriculum development for the country or consultancies / structured teacher training programmes for schools willing to adopt the free progress system, in part or in full. The Committee in fact notes that they:

... felt that the work of this Institute should be made available to larger groups of teachers in the country. We also note that the Institute can do much more terms of publications and in terms of undertaking training programmes, if the Institute can be expanded and facilities are provided for teachers' training programmes ... intensive research in these works is encouraged through various programmes of workshops, seminars ...⁶⁶³

As we note below, some exceptions aside, this work did not take place as planned. It calls for a fresh impetus to build a reflective culture across schools currently operating in silos and capacity building for research translation.

⁶⁶⁰ Report of the Visiting Committee, 2001, 35.

⁶⁶¹ Report of the Visiting Committee, 2001, 45.

⁶⁶² Report of the Visiting Committee, 2001, 31-3.

⁶⁶³ Report of the Visiting Committee, 2001, 31-3.

Seventh, resource constraints: the Report noted that schools do not have ‘adequate facilities to hold classes’, and that the ‘lack of these facilities ... prevent the right and full utilization of available talents.’⁶⁶⁴ Accordingly, it signalled that infrastructure needs ‘to be developed, at least to a minimum level of efficiency and fruitful activity of educational research.’⁶⁶⁵ In particular, it notes as far as ‘the development of teachers’ training programme is concerned’, there are ‘inadequate facilities ... that deserves immediate support.’⁶⁶⁶ Equally, insofar as extension work is concerned, the Report notes that the

focus on facilities required for extension work are extremely limited and they can even be considered to be poor ... It is, therefore, necessary that SAIER is assisted so as to meet its deficiencies in respect of buildings and equipment.⁶⁶⁷

As we note below, the concern with inadequate facilities for teacher training and extension work remains today in the context of the under-resourced Teacher’s Centre. Based on these considerations, the Report concluded:

SAIER is a powerful Centre of educational research, that the work it has done so far is extremely valuable, and the future development which has been envisaged in the development proposal, if supported by the Government of India both in terms of academic collaboration and substantial and sustained financial assistance, SAIER will turn out to be a world-class Institute, capable of making major contributions to the contemporary educational and cultural needs of the country and even of the world.⁶⁶⁸

Accordingly, the Report recommended that Plan Grants against existing services should meet the full expenditure on account of maintenance of researchers. As far as the Development Programme was concerned, it proposed an outlay of Rs. 4.75 crores per year between 2002-2007 (the 10th Five-Year Plan) that *could* ‘be increased during the 11th Five Year Plan, after evaluation of the progress and performance of the work.’⁶⁶⁹ This funding, it bears noting, was not as an educational subsidy, but tied to ‘the immense potentialities of the Institute to serve the larger educational needs of the country ...’⁶⁷⁰ Importantly, this period also marked the shift in Central Government funds which now started coming into SAIER as grants under the Central Government’s Five-Year Plans (‘Plan Grants’) from 2002 to this day. The inflow of ‘Plan Grants’ meant (i) the formal recognition and promotion of SAIER’s work by the Government of India and (ii) expanded accountability in terms of evaluation of outcomes of projects undertaken.

⁶⁶⁴ Report of the Visiting Committee, 2001, 32-3.

⁶⁶⁵ Report of the Visiting Committee, 2001, 32-3.

⁶⁶⁶ Report of the Visiting Committee, 2001, 33.

⁶⁶⁷ Report of the Visiting Committee, 2001, 34.

⁶⁶⁸ Report of the Visiting Committee, 2001, 38.

⁶⁶⁹ Report of the Visiting Committee, 2001, 43-4. Visiting Committee granted a total of Rs. 26 Cr for the five-year plan period between 2002-2007, as against SAIER’s request for Rs. 129 Cr. for the same plan period.

⁶⁷⁰ Report of the Visiting Committee, 2001, 48.

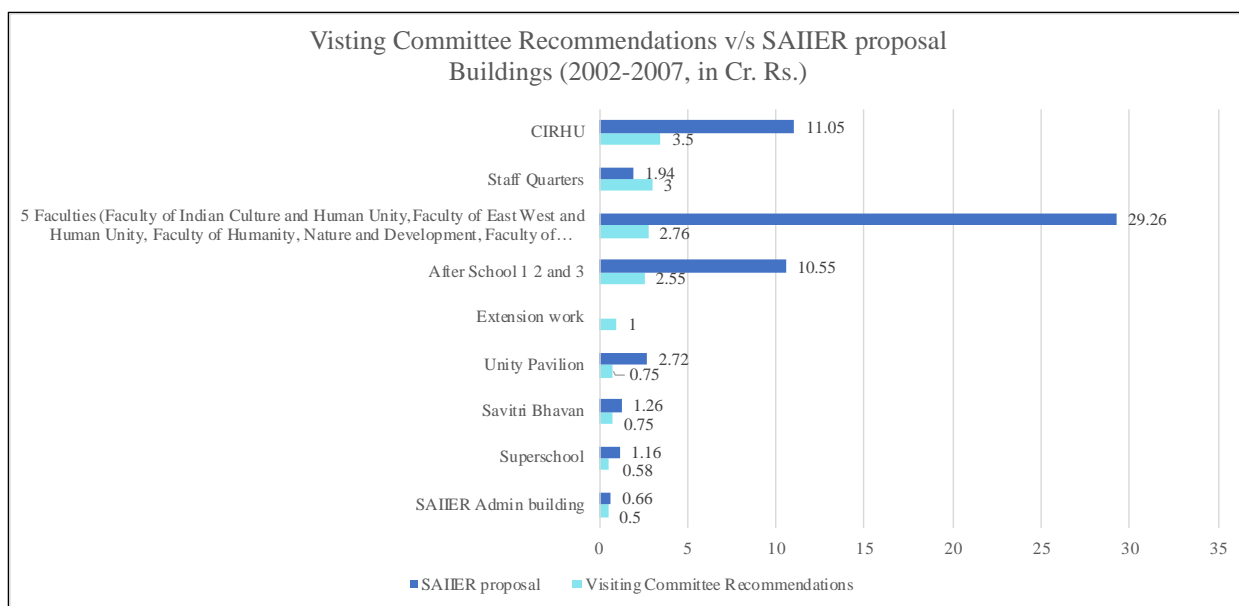

(Project-wise Visiting Committee recommendations to SAIER's Plan Grant Proposal (2002-2007). *Source: Visiting Committee Report, 2001*)

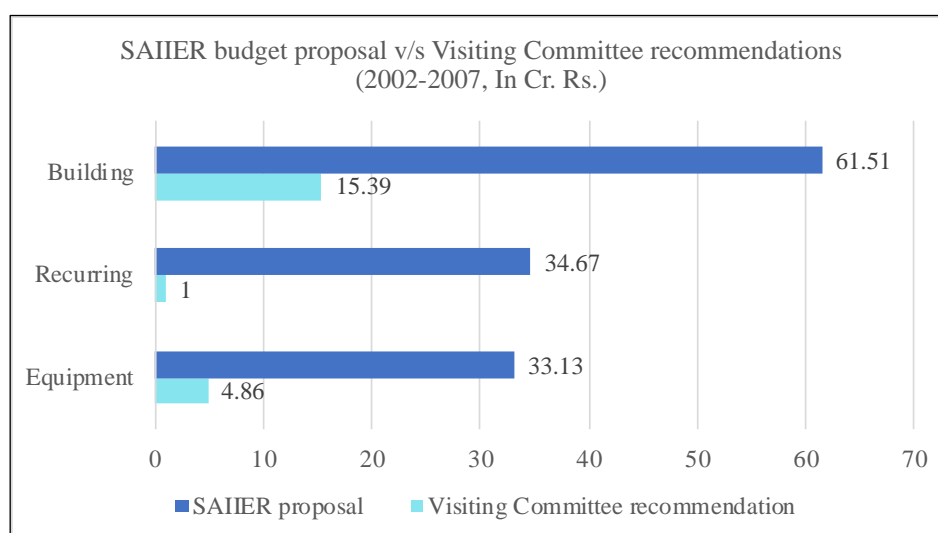

(Heads of expenditure in the Visiting Committee recommendations to SAIER's Plan Grant Proposal (2002-2007). *Source: Visiting Committee Report, 2001*)

Substantial funding was thus approved by the Central Government on these lines. However, records indicate that most work-streams identified in the Plan Grant Proposal were not systematically developed, indicating accountability concerns: the seven research faculties were not organized along the lines proposed (and are, as of today, not in operation); curriculum development, publication of learning materials and development of teacher training programs for broader use in India were not finalized; the stress on publication was met with limited success; plans for CIHRU or the multi-disciplinary research framework too did not materialize. Nor, as far as we are aware, was there any dedicated work-stream / organizational setup within SAIER to develop these projects – by some accounts, Professor Joshi's leadership was

instrumental in work at the time, and after him, there was a flagging of energies on this front. Equally, though the Visiting Committee Report had indicated that appropriate increases to the grants could be made in the 11th Five-Year Plan (2007-12) after a review of work (given the grant of Rs. 26 crores as against the proposal of Rs. 129 crores), the records indicate that grant amounts remained relatively stagnant in the subsequent years, without fresh proposals based on targets accomplished in 2002-2007. It is also worth noting that, based on our interviews, there seems to be limited awareness in the educational sector in Auroville, of the plans for expansion and development in the Plan Grant Proposal, which served as a detailed blueprint for growth, with the following institutional structure proposed, yet not implemented in substance.

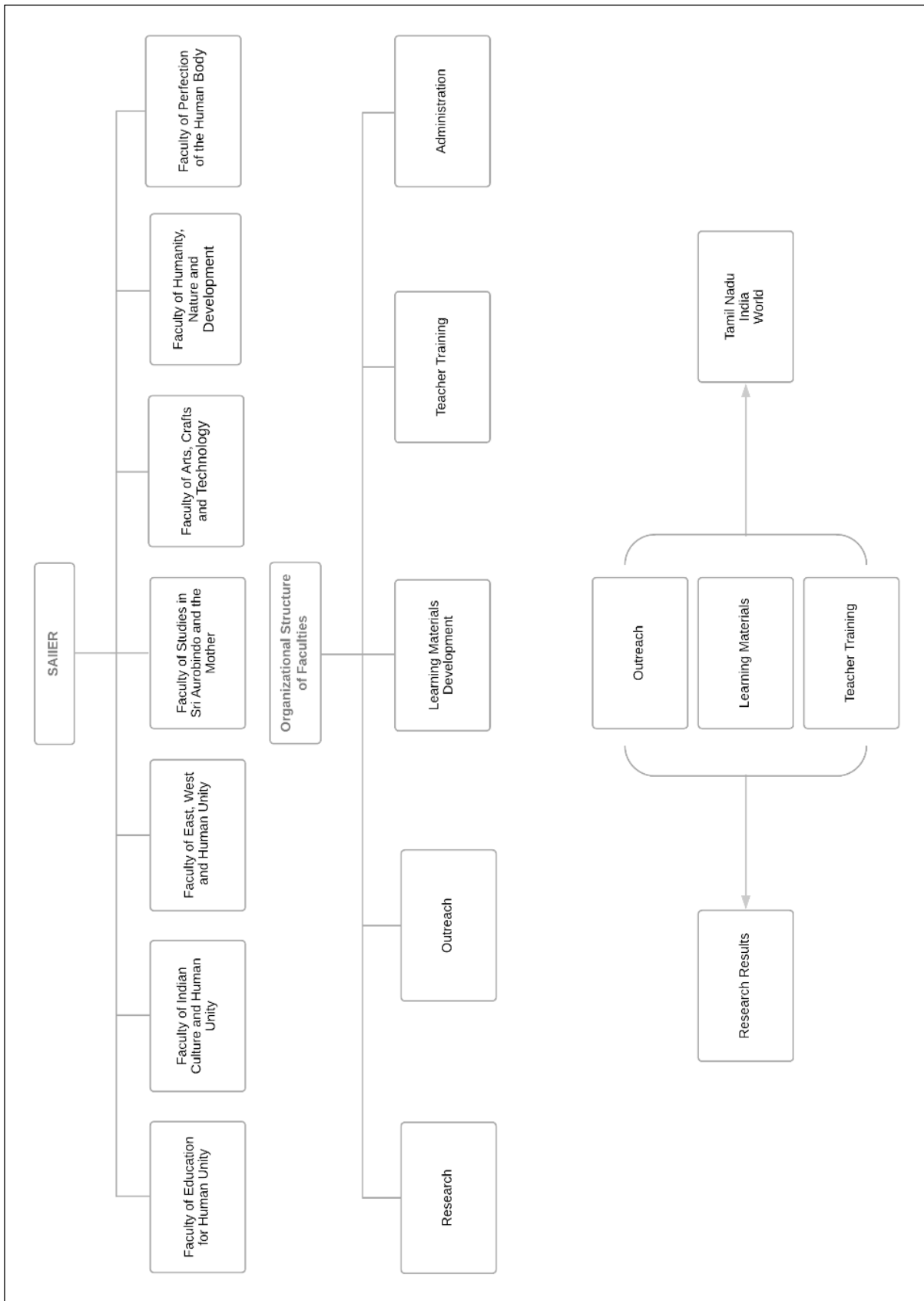

(Proposed organization of the Education Sector. Source: SAIIER Visiting Committee Report, 2001)

A quick analysis of successive educational budgets also reveals an over-dependence on foreign donations and Government grants (both Plan and non-Plan grants). From 1984 to 2002, SAIER received support from the Scheme of Assistance to the Institutions of Higher Learning of All India Importance (to the tune of approximately Rs. 20-30 lakhs per year), with approximately three times the amount coming from third-party donations. Given the high reliance on donations and the need for sustainable infrastructural development, the budget for 1997-2002 proposes a higher percentage of funds to be sourced from government grants (from Rs. 1.28 crores between 1991-96 to a proposed Rs. 5.56 crores between 1997-2002). This dependence on government grants, given the limited surplus available from income-generating units, persists till date, with institutional risks tied to external funding.

Moreover, it is interesting to note that the expenditure till 2007 was equally spread between research, infrastructure development and teaching maintenances, whilst subsequent years demonstrate a general decrease in research and infrastructure development spending (special projects aside), a concern expressed by those involved in the sector. We may also note that in plans from 2002-2012, a repetition of development proposals is observed along similar lines with no distinct value addition or follow up, review or evaluation of work done in relation to the previous Five-Year plans. For example, the proposals for pedagogical strengthening (teacher-pupil relations, development of learning material, outreach etc.) are largely drawn from (and in many cases, worded *verbatim* as) the work mentioned as ongoing in SAIER's previous Annual Reports over the years, without future planning requirements identified. Post 2012, as far as we are aware, it appears that no development plans for the education sector were drafted, as government grants continue to flow in based on previous recommendations. This carries an institutional risk: these grants were instituted in the 10th Five Year Plan based on the Visting Committee Report to enable Auroville's contribution to the educational sector in the country at large – absent benchmarks to assess work on this front (particularly as most outward-looking and research-related proposals were not acted upon), questions can be raised as to Auroville's claim to continuing funding.

Overall, the evolution of education planning in Auroville since 1984 reveals several challenges in relation to (i) the planning process (the nature and extent of consultations), (ii) implementation (improving the quality of human resources through capacity building and clear delegation of executive powers), (iii) a robust monitoring/review mechanism to assess progress vis-à-vis plan deliverables and (iv) the financial sustainability of running educational programmes in Auroville without reliance on government funds for recurring expenditure.

iv. Snapshot of the Sector Today

Nonetheless, while planned development is lagging (as in city-planning), the expansion and work of the educational sector continued through individual enterprise, with notable initiatives and work. As of the last available SAIER Annual Report, the educational landscape in Auroville comprises 42 sub-units, including eight Auroville schools, under the umbrella of the School Board, and six Outreach schools, six units or centres of research and a Teacher's Centre for capacity building.

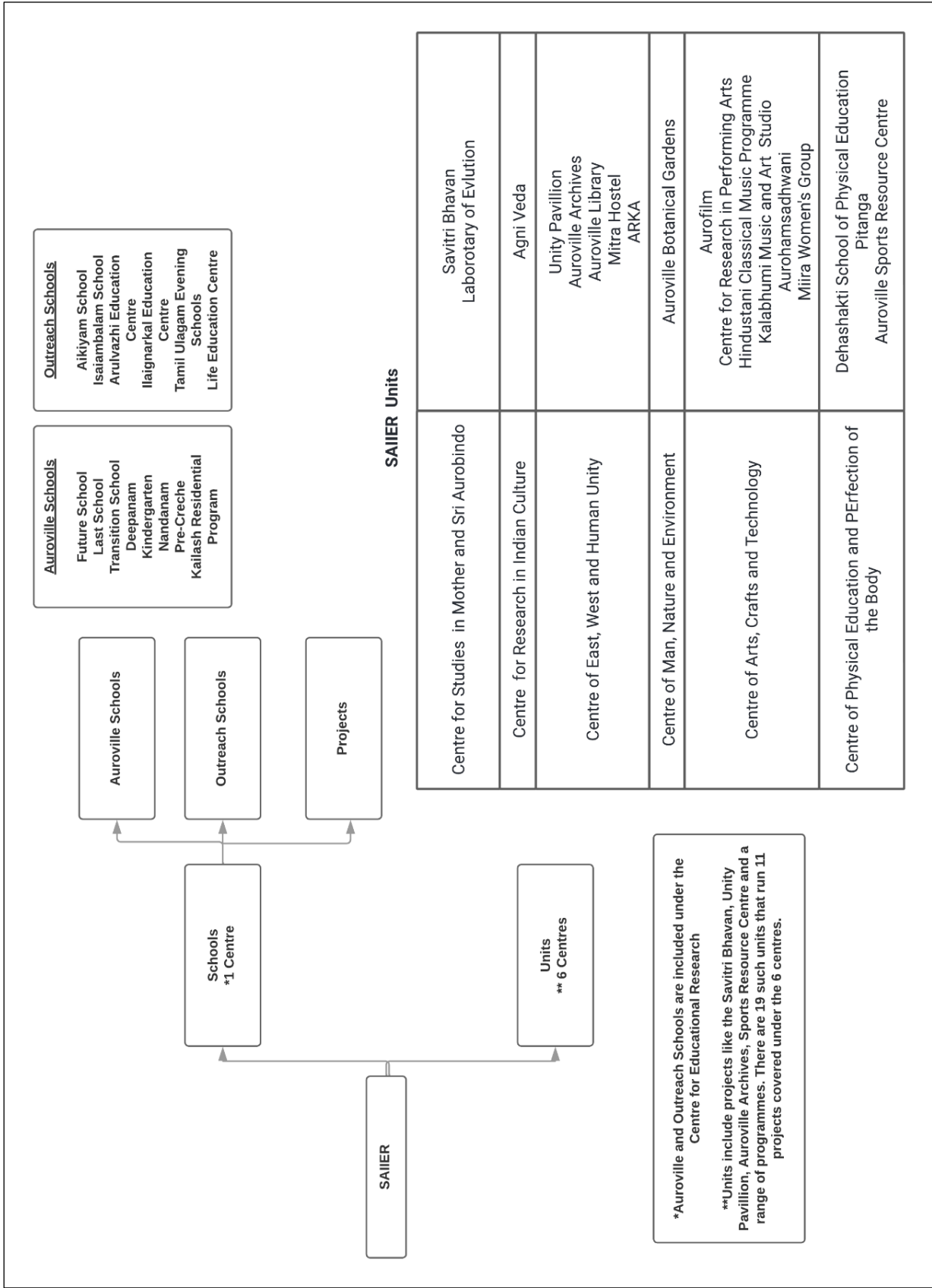

(Current organization of the Education Sector under SAIER. NB: The Centres are largely formal, not operational entities). Source: SAIER Visiting Committee Report, 2001)

A study of the qualitative aspects of schooling in Auroville – the pedagogical approaches and practices, particularly in relation to the five essays in Mother’s *On Education* – is outside our purview.⁶⁷¹ In general, it bears mention that the reflections of individual teachers across schools, reflected in the SAIIER Annual Reports demonstrates the dedication and of those involved in this sector and the vibrance of the sector. Based on the Annual Reports of each school, recent consultations conducted by SAIIER on the place of Mother and Sri Aurobindo’s thought and a survey conducted by us with Auroville schools, we note that there are a range of ongoing experiments:

- i. Models of facilitated co-learning.
- ii. Alternate assessment models, including portfolio rather than exam-based assessment methods, assisted self-assessments, process, rather than product, based assessments, year-long formative assessments rather than end-heavy examinations.
- iii. A range of pedagogical approaches, including experience and play-based learning models, reflective journaling practices, curated spaces for silence, individualized treatment and self-directed, teacher-assisted programming (for example, the Lotus Diagram in the Learning Community), a focus on exemplary and emulation-based teaching, limiting instructional and information based-teaching in favour of Socratic, dialogue-led learning and community integration, with service weeks, collaboration with units and community visits in Auroville and research in local cultural heritage.
- iv. Focus on the arts, sports and creative disciplines (including city-wide sports events organized by the Auroville Sports Resource Center, though the regularity and details were not detailed).
- v. Attempts to create multi-lingual classrooms, and notable attempts, still a work in progress, at local and cross-cultural integration.
- vi. A culture of student ownership, student-led journals and magazines.
- vii. Work around curated travel and exploration outside Auroville.
- viii. Innovative curriculum practices, including ‘Awareness through the Body’, ‘Building with Blocks’, Learning Centre’s ‘Peace Education’, a stress on ecological education through Seed to Plate programmes and a range of other initiatives.
- ix. Translation of Mother and Sri Aurobindo’s thought in teacher and faculty fora and school – for example, Last School reading circles, the Auroville project and Thursday Reading Circles in Isai Ambalam, *Savitri* sessions and the Auroville - Tamil Nadu seminars at the Arulvazhi Education Centre, though the practice on this appears variable across schools, and may require deeper examination.
- x. Initial forays in technology-based education, with Isai Ambalam’s adoption of Byju’s Online Learning Platform.

⁶⁷¹ Sri Aurobindo Institute of International Education Research, 2018 stands out as an insightful, if brief, reflection of learning practices.

- xi. The notable innovations in STEM Land, at Isai Ambalam, which was showcased by the Directorate of Education as a practical model to implement the National Educational Policy, 2020, Ilaigarkal and various initiatives in the Outreach schools, serving close to 3000 children in the bio-region, to progressively introduce free progress practices into culturally relevant forms within Board curricula, which deserve particular recognition, though space limits a more detailed appreciation.⁶⁷²

There appear however to be several systemic concerns. The records indicate that, in many cases, the translation of these practices into documented research – that allows both critical evaluation and assistance to other setups in the country – is a challenge. Accordingly, a more thorough study of the five layers of Mother’s ‘On Education’ and Sri Aurobindo’s ‘three principles’ in relation to schooling practices, conducted variably by individual schools over the years and begun more systematically SAIER in its May, 2023 consultations with Auroville schools, presents an avenue to document, discuss and evaluate teaching practices across schools. This could serve as a pathway to a common pedagogical research handbook – an Auroville Schooling Handbook – and a curricular framework that may be offered to schools outside Auroville, originally proposed to the 2001 Visting Committee. We discuss this below.

The Auroville School Board, which serves as a single window admissions portal to these schools, is currently an administrative body, with limited research interventions / inter-school interactions. Recent initiatives have been taken up in this regard – the Research Desk set up by SAIER in March 2023 to serve as a contact point to facilitate and support those who want to undertake, document or publish pedagogical research is a valuable step forward insofar as the problem concerns rigorous documentation, reflection and writing output (though we are informed that there has been limited uptake).

This limited focus on documented research is accentuated by challenges in capacity building and organizational structure. A move to bring together teachers from various schools was initiated in 2014-15, with the launch of the Teacher’s Centre at SAIER, as a space dedicated to teachers in Auroville/outreach schools that would encourage their professional development and reflections on collective learnings, challenges and identification of future needs. As of today, it appears that the work of the Teacher’s Centre is more responsive than instructive, i.e., prescribed, compulsory modules of training are not imposed on teachers to follow, rather, programmes are culled out specially in response to the expressed needs of teachers. For example, teachers approach the Centre for guidance on classroom management, materials or management of children with special needs. In response to teachers’ demands, the Teacher’s Centre has developed and is piloting a teacher training program for kindergarten certified by a Montessori Centre that applies the principles of integral education to meet the requirements of children with special needs, a supportive learning satellite programme and professional development programmes at Aikiyam School Kindergarten, with a variable involvement with other schools. The Centre is backed by Auroville educationists / long-term resident teachers, with associations with medical/psychology professionals (such as collaborations with the

⁶⁷² See, for example, the short description of the work at Udavi School, Agarwal, 2020; work at Deepam, Deepam, 2020; New Era Secondary School, NESS, 2020. SAIER’s Annual Reports provide yearly summaries, which we do not rehearse here.

Pondicherry Institute of Medical Sciences), but is operating under serious resource and personnel constraints (with one and a half maintenances):

The idea of a Supportive Learning Satellite, working independently from schools with maintenances targeted through the Teachers' Centre, emerged from the growing caseload of Lilaloka which was, at that time, working on extremely limited maintenances in a half-built facility, plus a Supportive Learning Service, operating from the Teachers' Centre, with no independent premises and no means of recruiting dedicated SLS teachers. There was a waiting list of students in need of support.⁶⁷³

The expansion and development of this Centre can assist in much-needed capacity building, a concern voiced by several schools and identified as the primary challenge at the 2015 Auroville Retreat. We discuss this below.

In relation to the approximately fifteen research units housed under SAIIER, the link between them is unclear, in terms of coordination or planning of research activities. As such, the Centres seem to be listed for formal administrative or legacy reasons to house particular projects, rather than as operational entities. The faculty structure proposed by the Plan Grant Proposal is reflected in subsequent SAIIER Annual Reports, but it appears that these are not active research clusters – rather, each individual unit is conducting work independently, with funding requests routed annually through SAIIER. As elsewhere, the necessary centralization under sub-zonal bodies, in this case SAIIER, appears weak.

In terms of the research output, the records indicate a variable output over the years across the listed research centres, with approximately twenty book volumes of independent research. A fuller examination of the published research, in terms of the reception of these works in the peer network, contribution to the existing literature etc. is required and beyond our scope. In general, published output in terms of original scholarship appears to be low. As the available information was limited, our review here is incomplete, subject to further study. The following points emerged from the records we were able to access:

- i. Without systematic research programs, clusters or faculties that can absorb researchers, individual, *ad hoc* research projects are the dominant mode.
- ii. SAIIER's policy for research grant allocation (in terms of supported areas, disciplines, outcome / impact etc.) is not clear in the records.
- iii. There is no generally defined research agenda / medium or long-term research development plan across disciplines, in the humanities, social sciences or STEM.⁶⁷⁴ A multi-disciplinary research framework – proposed by General Chatterjee to the Visiting Committee – is yet to develop. There is notable body of published research by individual residents in architecture, building technologies, water, land management and ecology and to a limited extent, cross-cultural philosophy, but a systematic research setup (with funding, infrastructure etc.) requires planning

⁶⁷³ Teacher's Centre Supportive Learning Project Presentation, 2022

⁶⁷⁴ See, Lung and Suryamayi, 2022, as a notable exception.

attention.⁶⁷⁵ For the STEM disciplines, the records do not indicate ongoing research programmes outside of architecture / sustainable building technology / work of the Centre for Scientific Studies; in terms of research in the arts, the SAIER Annual Reports contain references to events and individual training sessions conducted over the years in music, sculpture, theatre and dance (with acclaimed homegrown artists in some disciplines), but the records do not indicate a permanent research programme in these disciplines.

- iv. There appear to be no fellowship / funding opportunities to invite external researchers, or logistical / accommodation assistance, with the exception of the recent initiative by the Auroville Research Repository, to offset disincentives owing to the high cost of living in Auroville.
- v. Comparing year-on-year grants from SAIER Annual Reports from 2014-15 to 2020-21, most research projects seem to be short-term (less than one year), which is a matter of concern.
- vi. SAIER's research outlay for 2015-16, 2019-20 and 2020-21, years for which figures were available, was approximately 13, 16 lakhs and 38 lakhs, a low investment for the ambition and scale of Auroville's ideal research landscape. In this, more than 90% of the projects were short-term and individually-led and the rest routed through the defined sub-units; most project funding for each year is for events, exhibitions, training and extension activities or other one-off activities.
- vii. Savitri Bhavan and Agni Veda appear to be the only formal fora dedicated to publishing-oriented research in the collected works of Sri Aurobindo and Mother – whilst several compilations, short booklets and translations have been produced, independent scholarship, particularly in peer-reviewed journals or presses, on their works appears to be limited for a range of concerns, primarily funding and lack of researchers.⁶⁷⁶
- viii. In terms of funded research projects, the outcome / relationship to long-term research goals / defined outcomes is not clearly articulated. Particularly, peer-reviewed research, that can speak to a wider audience and validate rigour, appears to be low with a greater focus on study circles, activities, exhibitions, short booklets etc.

⁶⁷⁵ See, as a non-exhaustive list, works on architecture listed in the bibliography. A comprehensive catalogue of works is listed on the Auroville Research Repository, an important initiative to collate independent research work and anchor projects (though again limited owing to funding and infrastructure concerns). Most works on the platform are graduate theses or works by external scholars, not residents.

⁶⁷⁶ To the best of our understanding, scholarship has in general been limited, with the works of Kireet Joshi, Georges van Vrekhem, Rod Hemsell, Ruud Lohmann, Vladimir Yatsenko, Sharaddhavan, Hadnagy, Kosha Shah and Huchzermeyer standing out. We list these in the bibliography.

- ix. In terms of ongoing work, though our review is incomplete, the following projects seem to have growth potential and can be considered for systematic expansion: the natural language acquisition research related to ‘Education by Design’ projects and experiences primarily of children at Isai Ambalam School, including research on enhancing foundational literacy (presented and published since); research projects hosted at Centre for Research in the Performing Arts devoted to music, theatre and dance (though available information on these was limited); Svaram’s research on product development and instrumental classes,⁶⁷⁷ the *Savitri* encyclopaedia project begun at Savitri Bhavan; the Mother’s Flower Garden project, to complement earlier work in this domain; the research project on Increasing Water Literacy in Auroville; the development Laboratory of Sanskrit grammar modules at the Centre of Human Unity / Agni Veda and the book manuscript on the *Secret of the Veda*; the research infrastructure at the Auroville Library; the statistical work on impact of plastic usage as part of the ‘kNOw PLASTICS’ Educational Programme and Waste Less’ ‘garbology’ pilot, ‘Re-Centre’ and educational extension, particularly curriculum writing for Tamil Nadu;⁶⁷⁸ research into local ecology and tree identification with associated environmental education modules developed by the Auroville Botanical Gardens; research into Kalarippayattu, with the development of a guidebook; research on ‘Reviving Vegetable Diversity’ by the Centre for Excellence in Sustainable Agriculture; auto-ethnographic work by Suryamayi on prefigurative utopianism; the Citizen’s Assembly pilot and subsequent projects with the Dreamweaving initiative; the Teacher’s Centre’s research in Supportive Learning Satellites; research at the Centre for Scientific Research in renewable energy systems, appropriate architecture and building technology and waste water recycling (though we were not able to access details of precise research projects as of date) and at the Auroville Earth Institute on earthen buildings techniques; research at the Social Research Centre (though again details on current research projects was scarce).⁶⁷⁹

v. *Challenges and Development Priorities*

Given this brief overview of the educational sector, we address key institutional challenges and identify development priorities.

a. *Retaining Youth and Certification*

⁶⁷⁷ This unit is self-supporting and does not receive SAIER grants, yet may be integrated to allow for fundraising for extension services of their notable work. *See*, Auroville Foundation Annual Report, 2017-18, 30.

⁶⁷⁸ This is a significant achievement, the only instance to our knowledge, of a unit contributing to the educational curriculum elsewhere. The establishment of ‘Re-Centre’, to conduct research, test, develop and share innovative solutions to improve the management of resources and waste is also noteworthy. *See*, Auroville Foundation Annual Report, 2020-21, 21-2.

⁶⁷⁹ We were not able to ascertain the current research projects in many centres, as the descriptions in Annual Reports are general or sporadic and available information with SAIER was limited. This will require further study.

Auroville’s aspiration to the free progress system is distinct from standard pedagogical systems based on an instructive teacher-pupil relation, marks-based assessment and certification post-graduation. Such a pedagogical approach is therefore driven in large measure by the faith of children and parents’ in the vision and its practice – expectedly, this faith has been brought to question since the mid-1970s with parents’, and the learners’ own, concerns about the practical value of their education to be ‘equipped for life.’⁶⁸⁰ Particularly, the practical concern with the absence of certification, especially in the absence of higher institutes of learning within Auroville post high school, has featured in discussions since the early years. Youth are therefore confronted with two options – either pursue higher education outside Auroville (where the competition and metrics of assessment demand certification and a validation of skills/capacities acquired), or staying back in Auroville to learn ‘on the job’ through apprenticeships in domains of interests. The latter being contingent on the availability and quality of mentors and the structured formulation of a tertiary education system in Auroville, a significant rate of drop-out between primary level and high school is observed. Anecdotally, the rate of the drop-outs for Tamil and Indian children appears to be higher.

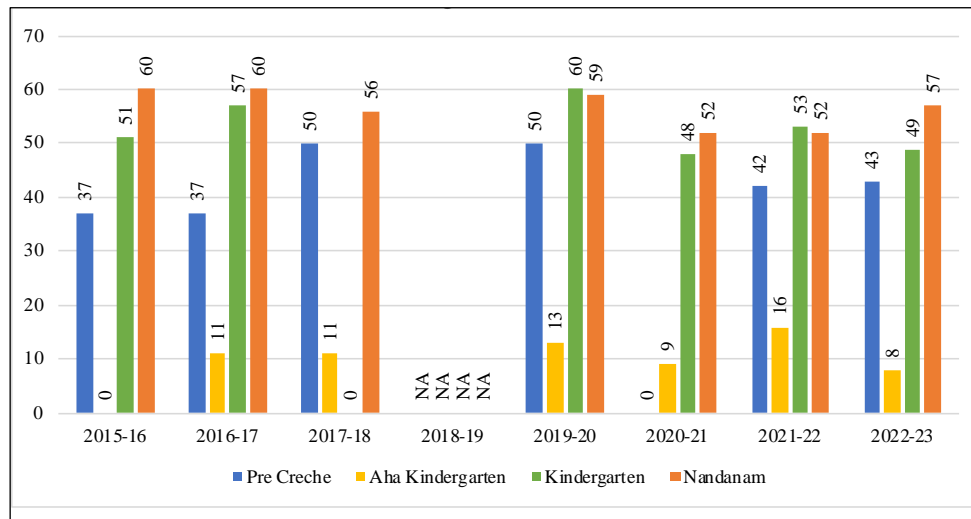

(Kindergarten enrolment, 2015-23. *Source:* SAIER School Board)

⁶⁸⁰ Thomas and Thomas, 2016, 76; Tiwari et. al., ‘Auroville Education Survey (1968-2013)’, 2016.

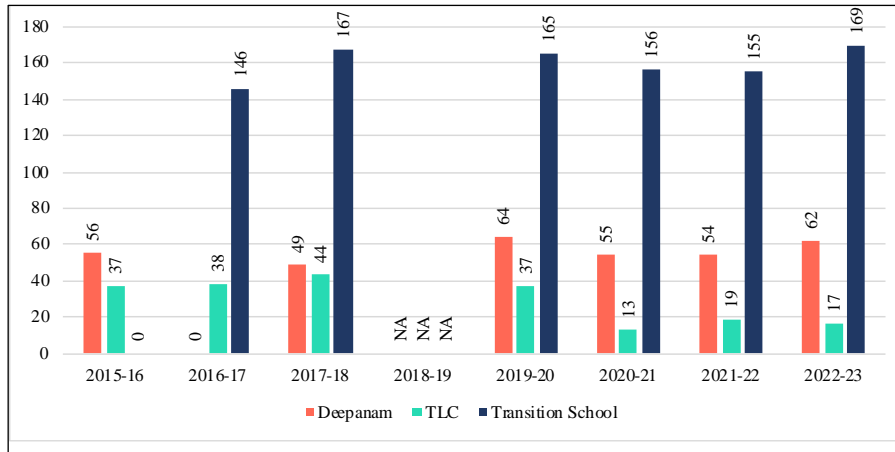

(Primary school enrolment, 2015-23. *Source:* SAIER School Board)

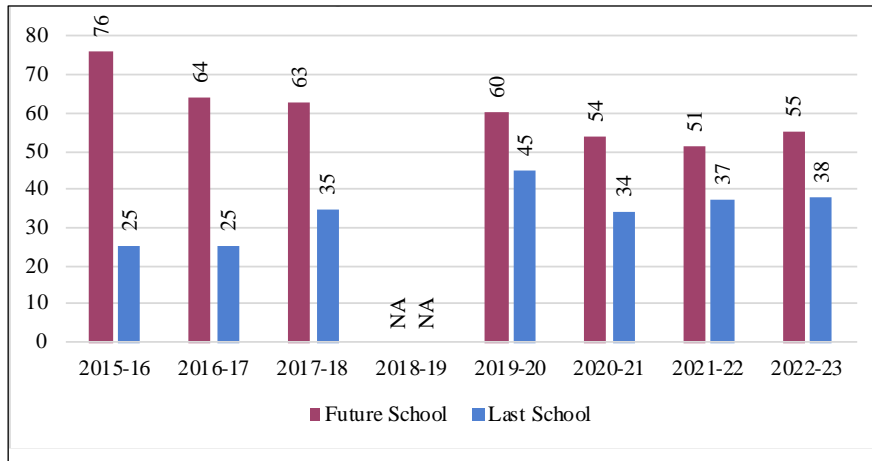

(High school enrolment, 2015-23. *Source:* SAIER School Board)

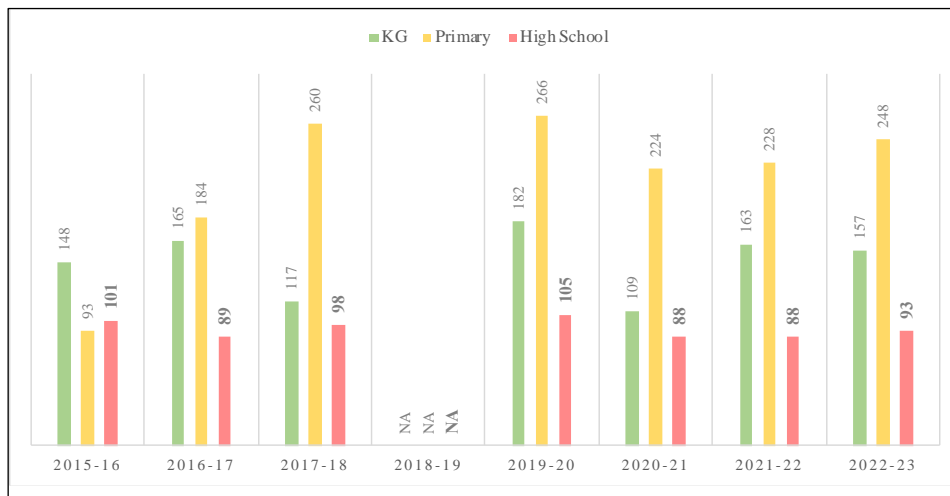

(Drop-out patterns (2015-2023). *Source:* SAIER School Board)

There is a trend of children dropping out post Transition School and choosing to either enroll in an Indian / foreign school board accredited school (CBSE/IGCSE/IB). Noting this pattern in the early 2000s, the Centre for Further Learning was established to provide an avenue for ‘those who wish to pass traditional exams, receive certification, or go abroad’ post-school:

The second external factor is the presence of another school, the Center for Further Learning, which gives a possibility to those who wish to pass traditional exams, receive certification, or go abroad. This has had two positive consequences on our activities: it has saved us from the pressure of those parents who want to give a ‘normal’ education to their children, and this in turn has permitted us to make of the free progress method truly a ‘choice’ that is freely chosen. For indeed, Free Progress has this particularity, that it can work only when it is consciously chosen by the children and the parents. For the growth of this free progress school, it appears to have been useful to have in its surrounding a non-free-progress system available ...⁶⁸¹

The debate on certification in Auroville has been a persistent one – as of 2015, the facilitators for the educational track at the Auroville Retreat noted ‘disagreements between certified/accredited vs. non-certified/non-accredited education’, with ‘severe skepticism (vs. the absence of the same) towards most if not all educational approaches and methods practiced outside of Auroville.’⁶⁸² The Full Report accordingly suggested a reconciliation:

8	In Auroville’s education no certificates must be issued.	Certificates in education are needed for higher studies outside Auroville	<i>Do not study for certificates but ask for one if needed as a reference for studies outside Auroville.</i>
---	--	---	--

(Source: Full Report, Auroville Retreat, 2015, 65)

Whilst naturally the competitive, examination-driven methods prevalent in various school boards / standard certification systems lend themselves to rote-learning, standardized assessment methods unsuited to true learning, dimming of creativity and confidence, narrow definitions of success measured in employment terms, fractured peer-relations, insufficient attention to the arts and sports and a range of other well-recorded limitations, it does not necessarily follow that the free progress or integral education system is incompatible with progressive forms of assessment, evaluation and certification. It goes without saying that the keynote of psychic and spiritual education in the integral education system stands out in any comparative assessment of educational thought and is singularly unsuited to standard assessment formats. Yet, the ‘largely unaddressed’ extremes between certification and non-certification are premised on the idea that *any* kind of certification is incompatible with the free progress method – yet, this may not necessarily be the case. Progressive assessment methods, with which Auroville and aligned institutions, have been experimenting offer realistic ways to dissolve the tension. The debate hinges on a reading of Mother’s words on the subject:

⁶⁸¹ Sri Aurobindo Institute of International Education Research Annual Report, 2001-2002.

⁶⁸² Full Report, Auroville Retreat, 2015, 40.

[Question: Why are no diplomas and certificates given to the students of the Centre of Education?]

For the last hundred years or so mankind has been suffering from a disease which seems to be spreading more and more and which has reached a climax in our times; it is what we may call 'utilitarianism'. People and things, circumstances and activities seem to be viewed and appreciated exclusively from this angle. Nothing has any value unless it is useful. Certainly something that is useful is better than something that is not. But first we must agree on what we describe as useful—useful to whom, to what, for what? For, more and more, the races who consider themselves civilised describe as useful whatever can attract, procure or produce money. Everything is judged and evaluated from a monetary angle. That is what I call utilitarianism. And this disease is highly contagious, for even children are not immune to it. At an age when they should be dreaming of beauty, greatness and perfection, dreams that may be too sublime for ordinary common sense, but which are nevertheless far superior to this dull good sense, children now dream of money and worry about how to earn it. So when they think of their studies, they think above all about what can be useful to them, so that later on when they grow up they can earn a lot of money. And the thing that becomes most important for them is to prepare themselves to pass examinations with success, for with diplomas, certificates and titles they will be able to find good positions and earn a lot of money. For them study has no other purpose, no other interest. To learn for the sake of knowledge, to study in order to know the secrets of Nature and life, to educate oneself in order to grow in consciousness, to discipline oneself in order to become master of oneself, to overcome one's weaknesses, incapacities and ignorance, to prepare oneself to advance in life towards a goal that is nobler and vaster, more generous and more true ... they hardly give it a thought and consider it all very utopian. The only thing that matters is to be practical, to prepare themselves and learn how to earn money. Children who are infected with this disease are out of place at the Centre of Education of the Ashram. And it is to make this quite clear to them that we do not prepare them for any official examination or competition and do not give them any diplomas or titles which they can use in the outside world. We want here only those who aspire for a higher and better life, who thirst for knowledge and perfection, who look forward eagerly to a future that will be more totally true.⁶⁸³

Mother's concern is with a 'utilitarian' system of education that ties itself *solely* to monetary success or employment, one that does not value learning and the development of the learner's faculties for their own sake. Accordingly, education at the Sri Aurobindo International Centre for Education, in the context of which this remark was made, does not prepare children *for* official examinations or competition, yet offers them a certificate that, by virtue of a notification from the Ministry of Education, acts as a proxy for one.

The concern in Mother's discussion is not with certification *per se*, but with certification requirements that eclipse the learning process. Auroville schools already experiment with a range of assessment methods, and indeed, pedagogical research (at primary, secondary and tertiary levels) globally has developed a body of literature on this subject that allows for

⁶⁸³ Mother, CWM, 2002, Vol. 12, 351-2.

learning-sensitive, personalized / examination-free certification models – if certification methods can be developed as *accurate markers* of true learning and ability, the emerging trend globally in progressive institutions, the tension can be dissolved.⁶⁸⁴ This is a realistic possibility today – research to evaluate these options, yet not undertaken at a policy level, can be explored. We were not able to locate any feasibility study on the possibility of a *sui generis* certification within the free progress system that could institutionalize the alternate assessment methods piloted in various Auroville schools over the years. This was the direction suggested by the Plan Grant Proposal in 2001, with draft curricula to be adopted across the country. Auroville’s experiments with alternate assessment methods, recorded in available literature. This presents a fertile opportunity to leverage existing knowledge to develop a *sui generis* certification system (an ‘Auroville School Certification and Accreditation’ system) that caters to the core tenets of the free progress method whilst validating ability and providing students the necessary support to enter professional fields of study outside Auroville if they so wish.

In sum, the stress of Mother’s remark above, if our reading is valid, is not against certification as such, but against certification as the primary goal of learning – if so, a free-progress certification system can provide a *via media* for Auroville youth, and also serve as a notable contribution to the educational landscape in the country, where there is a felt need for an accessible alternate to the existing boards (CBSE, ICSE etc.). The recent push of the National Education Policy 2020 to redevelop the National Curriculum Framework, reduce the curriculum load, introduce flexibility in curriculum design with a reform of assessment methods to support student development, presents a timely opportunity to study this option, resuscitating the 2001 Plan Grant Proposal. The 2015 Retreat suggested a move in this direction, proposing a task group to define the parameters of integral education including a ‘quality label’ of Auroville education – what was there referred to as ‘AV Identifiable Education’ – by the of the year, a task that remains to be done.⁶⁸⁵

Equally, this pathway will allow for the substantial learnings of pedagogical experiments conducted in Auroville schools over the years to be concretized and studied in a systematic manner, thus allowing for generational transmission and the production of reflective study-material and publications that can meaningfully engage with other movements in this direction globally. A major concern, voiced over several conversations, was the absence of translating on-the-ground research into published material and the limited interactions between Auroville schools to generate a mature *body* of pedagogical thought, as opposed to individual experiments: working towards an Auroville School Certification can provide the necessary collective push in this direction, bringing schools closer and recording experiments across schools for the benefit of others.

⁶⁸⁴ See, for example, OECD, 2017; Andrade, 2019; Elkhoury, 2020; Deng and Carless, 2010; Black and Wiliam, 2018; Branco, 2021; Reeves et. al., 2009; Gipps and Stobbart, 2003; Caliskan and Kasikci, 2010; Boubouka Papanikolaou, 2013; Hamayan, 2008; CERI, 2008; James and Simmons, 2007; Aha, 2022. Comparative research of Auroville’s experiments in this field with scholarship elsewhere presents exciting possibilities.

⁶⁸⁵ Full Report, Auroville Retreat, 2015, 40. An integral education adaption of the School Quality Assessment and Accreditation Framework may be considered here as a template.

In the course of interviews in the sector, we were often met with a reluctance to engage with schooling and learning systems elsewhere, a point raised by the facilitators at the 2015 Retreat as well. Whilst a certain distance is understandable given the unique emphasis of the free progress method, an insularity is best avoided. An open and assimilative approach to progressive systems elsewhere can only render Auroville's own practice richer. There is now a substantial body of research globally across educational systems, both at the level of teaching practices and policy, that share a common alignment, though not complete correspondence, with the free progress method – as such, a robust engagement presents both a meaningful opportunity to learn and to contribute to the urgent task of developing alternate systems, allowing Auroville to emerge as a centre for world-class educational research. Finally, and not trivially, an Auroville Certification can generate a healthy income-stream through accreditation and training programmes, thus serving to secure the financial independence of the schooling system currently over-dependent on Government of India and private grants.

b. Pedagogical Experimentation, Peer-Review and Research

A recurring theme across education development plans through the years is to encourage publication and the development of learning material drawn from the rich pedagogical experimentations that have been unfolding in Auroville since the 1970s. In 1984, with the foundation of SAIER, a first seminar was convened in Delhi under the chairmanship of Professor Joshi towards consolidating learnings from varied schools and organizing them into structured teaching material. As a result, two key publications were produced, *The Aim of Life* and *The Good Teacher and The Good Pupil*.

In 2001, the Visiting Committee noted that educational experiments in Auroville carry value for 'in consonance with India's urgent needs of educational development.'⁶⁸⁶ In order to harness the potential of these pedagogical experiments, there is a need to document ongoing pedagogical research. It is useful here to clarify 'research' in this context: whilst practical experiments in teaching are reflected in the Auroville education landscape, research in terms of rigorous documentation and publication is lagging. Research in this sense involves the systematic generation of knowledge shared with peers in the field by way of contributing to the existing knowledge-base – whilst there are some notable works, SAIER's publications shared with us largely take the shape of short reflections by Auroville teachers/educationists, brochures/annual reports and some writings on educational philosophy (primarily compilations of the works of the Mother and early writings by Professor Kireet Joshi). These publications are largely circulated internally or to a select external audience of those interested in Auroville's growth. Reports and brochures are largely anecdotal, for e.g., narrating a student's or one teacher's perspective on the Body Awareness course and other such curricula. In general, development plans and annual reports express an understanding of research more in terms of practice and on-ground action, but rigorous documentation and examination of that experience using formal, systematic methodologies of data collection and analysis, as also reflective mapping of the practice to Mother's works, or other traditions of pedagogical thought, is limited. The Annual Reports usually list 'research' informally in relation to the work

⁶⁸⁶ Report of the Visiting Committee, 2001, 31-3.

undertaken in each school year-on-year (including workshops, courses taught, exhibitions held, booklets published etc.). For example, of the 81 publications listed in SAIIER's annual reports since 1986 – the understanding of research appears to be driven more by the focus on action in the day-to-day, which are valuable and necessary but require peer-review and translation. Research, in this sense, is yet to be embedded as a culture within the working of Auroville schools and the overall organization of SAIIER.

Some schools have formulated research agendas, with a curated documentation of their pedagogical practices, but the practice is variable across schools and years. Some noteworthy volumes produced in recent years – with critical research insights and comprehensive articulation of innovative curricula in discrete themes, alongside a range of children's books – but research translation appears to be weak.⁶⁸⁷ Whilst our review is limited, based on materials made available to us, these are nascent trends that require strengthening and support.

This concern was identified at the 2015 Retreat, with a 'milestone' to 'transform SAIIER into a research organization' by 2016. In 2019, however, the then-head of SAIIER had indicated in 2019 that the 'development of education materials' was not a priority, with 'far too many materials available ... [and] not enough time to use them'⁶⁸⁸ – whilst our review indicates that the development of education materials in various, indeed most, disciplines still requires substantial work (a matter for further study), the organization of existing materials and effective translation into published handbooks etc. is necessary at any rate to allow for critical reflection and systematic development year-on-year – as such, these materials can be made available publicly to contribute to the educational landscape in India, as was proposed by SAIIER to the 2001 Visiting Committee. Indeed, the viability of continuing Plan Grants absent this function is questionable.

From interviews, it seems that human resource constraints and the multiple roles played by teachers (as administrators and mentors) spares little time for dedicated research. As a result, there is a conspicuous absence of peer-reviewed research studies, of the kind published in leading national and international journals, whereby educational experiments in Auroville can speak to emerging developments elsewhere. As such, encouraging teachers and educationists – through initiatives like the Research Desk, platforms to match writers with teachers, development of research handbooks, stipends / maintenances dedicated for publication and / or research, conducting a yearly research conclave amongst Auroville and Outreach schools to share research output as a pathway to write-up – is important to translate experiments into writing: peer-reviewed research work promises to (i) generate well-documented knowledge from the on-ground experiences of working with children, (ii) contribute to the growth of knowledge and practice by eliciting feedback and learnings from other practitioners in the field, (iii) allow Auroville to concretize learnings over the years, and generate a body of pedagogical knowledge that can sustain institutional memory and (iv) put Auroville's unique experiments

⁶⁸⁷ See, for example, Sri Aurobindo Institute of International Education Research, 2018 (particularly, Watts' introduction); Marti and Sala, 2010; Marti and Sala, 2020; Sri Aurobindo Institute of International Education Research and Last School, 2010; Watts, 2018; Dini, 2016; Aikya, 2015; Fouladoux, 2013; 'Taking Care of Pre-School Children', undated. Tiwari, 2002, presented at *the* national seminar on education organized by the Indian Council of Philosophical Research, is a perceptive reflection on the sector.

⁶⁸⁸ Ayer. et. al., 2019, 38.

‘on the map’, which will aid in drawing aligned researchers and practitioners to Auroville to bolster efforts to increase population numbers. In this context, Auroville may also consider housing a peer-reviewed educational / pedagogical research journal, plugging a gap in India’s research landscape in general, with a yearly conclave – the Auroville Educational Research Conference – as a focal point for researchers from across the world, and reviving the publication of *Ritam*.

In this context, it may also be helpful to reflect on Professor Joshi’s detailed proposal for a ‘Children’s University’, that can serve as a useful blueprint for the organization of SAIER’s research-wing in conversation with emerging pedagogical scholarship pushing along these lines.⁶⁸⁹ Professor Joshi’s proposal contains several key features, worth outlining: (i) it envisages that ‘affiliation will be granted under this University for any school for purposes of experimentation and implementation of innovative programmes of the University’,⁶⁹⁰ with supervision and monitoring of these establishments, which serves as a pathway to establish an independent Auroville School Accreditation system discussed above; (ii) it anticipates ‘innovative testing services ... which will free the present examination system from the current limitations’, thus concretizing alternate assessment methods within a certification frame;⁶⁹¹ (iii) it proposes the establishment of research councils, with full-time fellowships attached to professorial positions, with doctoral programmes, to generate an independent research engine; (iv) it identifies 74 discrete areas of research, from pre-natal care to secondary education, across disciplines, with a particular focus on language training, relevant for Auroville’s multicultural context; (v) it proposes a centre for extension services to work with state and central governments to address the broader educational landscape; (vi) finally, it proposes the institution of a peer-reviewed research journal.

While space limits a more detailed discussion of the proposal, it suggests an institutional architecture to address Auroville’s educational ideal, as also to render services to the rest of the country, concerns that have featured regularly in the records since SAIER’s establishment in 1984. Professor Joshi’s proposal thus provides a helpful template to chart Auroville’s future planning efforts. At any rate, this would require a dedicated and concerted effort to build capacity and reorient SAIER’s institutional architecture, with research clusters / centres dedicated to each vertical with full-time professorial and / or research positions, including we may suggest doctoral work, to develop a culture of research embedded within the schools. Currently, to the best of our knowledge, SAIER does not house research fellowships independent of the schools, which can be explored for the future to generate a standalone research environment that both attracts external scholars and provides the necessary impetus to those in the sector within Auroville to reflect on and translate their work into a rigorous research output.

Equally, as similar concerns with pedagogical experimentation and progressive education now motivate institutions globally, partnerships and exchanges with leading schools – for example, those of the Krishnamurthi Foundation, United World College and others, including several

⁶⁸⁹ Joshi, 2010.

⁶⁹⁰ Joshi, 2010, 21.

⁶⁹¹ Joshi, 2010, 22.

Integral Education Schools and youth programmes across the country, for example at Mirambika, New Delhi, the Sri Aurobindo Society Youth Programme – and universities engaged in similar work – for example, the Graduate School of Education at Harvard University, the Department of Education at the University of Oxford and others – can be explored to generate a healthy interchange of faculty and students. As of today, whilst some schools have external engagements, these are relatively unstructured with limited in-residence research programmes. In general, comparative research with aligned pedagogical approaches, of the Montessori, Waldorf and other methods, presents a meaningful area of inquiry that may be formally housed at SAIER.

c. Curricular Integration

An integration of Auroville’s founding ideals, history and philosophy, as also current civic issues (in terms of urban planning, manifestation of the Galaxy, environmental conservation, outreach etc.) into the school curriculum, to enable healthy debate and informed opinions, may be considered to develop a cultural ethic that allows the next generation to effectively participate in city-building. This is particularly important because Auroville youth in most cases have not made a conscious decision unlike parents, and may have a limited experience of life elsewhere which can serve as a model for comparison or choice – an understanding of Auroville’s founding rationale is thus necessary to allow the youth to evaluate matters objectively outside the usual frames of reference they may be accustomed to. This would require innovative curriculum development, with immersive participation and regular dialogue with those involved in each sector – this may be developed by each school independently (for example, as in the ‘Explorations in Education’ initiative at Aha), or coordinated through SAIER. Based on conversations with those involved in the sector, general awareness on these issues is variable, and generally low. Focus group respondents in Ayer et. al.’s study, for example, similarly identified the need to develop ‘values and norms to ensure informed participation in Auroville’s organization and governance.’⁶⁹² As such, a live civic education within schools may avoid the recalcitrant divides of the last two decades, with a reflective dialogue going forward with the next generation.

Further, the practice of integrating Auroville units within the curriculum may be considered, whether through service weeks, externships / apprenticeships with units, part-time faculty drawn from units etc., to develop a system of embedded learning, in line with Mother’s ideals. We are given to understand that these practices are adopted, with a varying emphasis, in some schools, but require coordination and strengthening, particularly to provide a firm institutional architecture by which students access to learning opportunities within units can be facilitated as part of the curriculum. We consider this below in the context of Mother’s naming of the After, Super and No School, to suggest a city-wide embedded learning programme post-graduation – a similar format may be developed across schools as well to create an institutional architecture that allows a settled integration of Auroville’s schooling system within the broader community as individual awareness or capacity to access may be limited given social location.

⁶⁹² Ayer et. al., 2019, 27.

In particular, modules on entrepreneurial education, with school-based incubators, curricular integration with commercial units etc. can be considered (building on initiatives such as the Future School Investment Group and learning from similar experiments elsewhere), as we are given to understand a general sentiment of aversion amongst the youth to commercial activity. Proposals along these lines were mooted at the 2015 Auroville Retreat to ‘make units of Auroville part of the educational experience’, with a December, 2015 deadline, yet the records do not indicate if any headway was made in this direction.⁶⁹³

Finally, we were not able to access literature on technology-leveraged learning in Auroville (other than the acclaimed work of the AIAT / STEM Land). Substantial research has been conducted, particularly in STEM subjects, globally, which may be explored for integration within the Auroville system.⁶⁹⁴ SAIIER may also explore the possibility of establishing a Centres of Excellence in Educational Technology, proposed by the National Education Policy, 2020.

d. Inter-School Linkages

A concern voiced by several in the field was limited interactions between the various Auroville and Outreach schools, with each operating as an independent ‘island’ – as a result, there is little cross-pollination across the schools or sharing of research, to address challenges and develop solutions through the collective wisdom of those involved in the sector. The 2015 Auroville Retreat and Ayer et. al. both record this concern, yet the records do not indicate any remedial action since.

Whilst each school naturally retains its freedom to develop curriculum, limited interactions between schools tend to unhelpfully isolate learning environments and create a sub-optimal environment for collective research. The Auroville School Board and SAIIER, we are informed, function as administrative centres for school admissions and funding requests, but have historically played a limited role in coordinating research activity across the schools. In interviews, there was uncertainty as to SAIIER’s place in the Auroville education landscape in this regard, with some conversants suggesting a more involved role, whilst others preferred to operate in their own domains.

Given natural variations in each school’s approach, it seems helpful to have a common platform to share research, develop cross-school offerings and integrated teacher training workshops. The importance of cluster and network dynamics in research innovation is a key design principle, manifested spatially in the Education Loop.⁶⁹⁵ In this, Auroville may consider:

- i. A city-wide Learning Management System, with dedicated portals for each school, comprising curricula, description of learning objectives and materials, outcomes, feedback loops, self-assessment / teacher-assessment forms.

⁶⁹³ Full Report, Auroville Retreat, 2015, 41.

⁶⁹⁴ See, for example, Kärkkäinen and Vincent-Lancrini, 2013.

⁶⁹⁵ See, for example, Mphalele, 2012. This is equally a consideration for tertiary university frame proposed below.

- ii. A termly or yearly conclave organized by SAIER across schools as a regular platform – the Auroville Teachers Forum, or howsoever called – to present and discuss work undertaken, with peer-review, and identify projects / research areas for the next term / academic year, with the results published to systematically generate a cohesive body of literature documenting Auroville’s experiments year-on-year. Alongside, SAIER may explore the possibility of a Research Handbook, to collate and distill learnings across schools into a single document with a range of curricular material: this can allow for institutional continuity in Auroville, support capacity building, allow for critical reflection and peer-review, and serve as a helpful resource for schools elsewhere. As of today, some exceptions aside literature on the curricula, learning methods and materials, or well-rounded expositions on Auroville’s experiments with the ‘free progress’ method are not available publicly in an organized manner.⁶⁹⁶

- iii. Whilst SAIER indicated in 2018 that there is a plethora of learning materials developed in Auroville, others have argued that there is a lack of diversity in curricula.⁶⁹⁷ Many conversants similarly raised issues concerning curricular approaches in various Auroville schools – insufficient rigour / discipline, insufficient attention to intermediate literacy / numeracy, weak language training, limited access to advanced classes / specialized tutorship for gifted students, vaguely-defined / weak assessment processes, limited emphasis on the STEM subjects, weak vocational / skills training, limited interaction with communities / schools / peers outside Auroville, too much / too little focus on assessments, need for greater reflection on Mother and Sri Aurobindo’s texts, need for a clearly articulated pedagogical philosophy, need to address the culture of drug-usage amongst sections of the youth etc. While we are not in a position to comment on specific issues, a *permanent and regular platform* for inter-school exchange, facilitated by SAIER, can make concerns transparent, invite regular peer-review / feedback and allow teachers to work together on common challenges. Collaboration and regular exchange are key. As elsewhere in Auroville, the decentralizing impulse towards free variation in each school, tends here to a dissipation of energies. This now needs an appropriate corrective, by way of consolidation under SAIER, to generate a cohesive, yet diverse, schooling system.

- iv. A five-year Research Agenda with a funding allocation policy, to systematically develop a body of educational research, rather than sustaining *ad hoc* projects (where duplication of work is likely, as the records indicate) – the agenda may identify priority research areas, as in the 2001 Plant Grant Proposal or otherwise, that schools may apply against with proposals, identifying the methodology, timeline, expected learning outcomes, contribution to the existing literature etc.

⁶⁹⁶ See, as examples, wonderful documentation by Aha, compilations by Learning Centre; Sri Aurobindo International Institute of Educational Research and Last School, 2010; Watts, 2018; Fouladoux, 2013; Marti and Sala, 206, 2010.

⁶⁹⁷ Ayer et. al., 2019, 26.

e. *Teacher Training and External Offerings*

The importance of trained teachers to free progress system naturally cannot be overstated – SAIIER’s education plans from 1997-2012 emphasize capacity building of teachers within Auroville to nurture their role as ‘animators’ and ‘observers’, making them accessible and sensitive to understanding children’s needs and capacities. Proposals are also made towards harnessing capacities of interested Auroville youth and teachers outside Auroville through assistantships with Auroville teachers for 1-2 months, apprenticeships for youth interested in pursuing a teaching career and monthly workshops for teachers in nearby villages. Naturally, a core challenge is that given the experimental and constantly evolving nature of the learning process, teacher support and capacity building cannot be instructive or a one-size-fits-all. That is, a conventional handbook-based ‘training’ model is not conducive. A collaborative support approach resting on a healthy exchange of learnings between teachers across varied schools and feedback loops involving parents and children, through a structured platform is needed to strengthen capacities.

Various schools indicated in conversations that training young teachers is a challenge, particularly at the school level given demands on time and resources. In most cases, teachers are brought up informally through a range of semi-structured apprenticeship and mentorship models, dependent largely on self-study and availability in each school. A more structured programme across schools, housed under SAIIER, for professional teacher training modules integrated within each school seems necessary to systematically develop capacity, both in-house within Auroville and for teachers elsewhere interested in the Auroville method. This was a constant concern raised in interviews, with a *shortage* of teachers well-versed with the free-progress method identified by most, though not all, conversants, as a systemic problem that is difficult to solve locally – several expressed a felt need for SAIIER to take up this task with a formal Integral Education Teacher Training Programme as a pathway for residents interested in contributing to the sector.

An attempt in this direction was made with the establishment of the Teacher’s Centre in 2014. The Centre was imagined as a space to encourage needs-based professional development of teachers in Auroville and Outreach schools – this model has been partially successful in identifying and responding to critical needs, as is evident in the evolution of the Supportive Learning Programme, a structured programme to address the needs of special learners and regular Montessori trainings conducted for teachers on request. Yet, the work of the Centre is limited owing to the following factors: (i) resource crunch: the lack of adequate financial and human resources (with currently one and a half maintenances) does not allow the Centre to adequately address the demand from teachers, engage in independent research activity or to plan for the future with modules for capacity building / continuous learning programs. Ayer et. al. similar record ‘inadequate social and economic support to teachers’ as a concern; (ii) teacher response: any teacher ‘training’ model in Auroville relies on teachers’ voluntary participation; over the years, the response from teachers Auroville schools has been limited, with a relatively greater uptake from the Outreach schools; (iii) knowledge sharing: as we discussed above, each school is generally considered an independent microcosm of educational experiments and

growth, with no formal, structured platform (such as a Teacher's Conference / yearly or termly conclaves) to facilitate the collective participation of and knowledge sharing among schools and teachers.

Given this, developing common modules for teacher training seems necessary to secure a stream of educators, provide a supportive environment to those interested in entering the education landscape and leverage Auroville's existing capacity for future development. In this, formal apprenticeship programs for new residents, partnerships and exchanges with aligned schools in India and elsewhere and formal short to medium term training programs for teachers elsewhere may be considered. This extension activity was part of SAIIER's founding ideal – 'providing to teachers from India and abroad an opportunity ... work with experienced teachers for a short duration of two to three months' – yet has not been developed systematically thus far.⁶⁹⁸ Ayer et. al. had similarly recommended the 'setting up of an institutional structure for teacher professional development' in 2019, though the then-head of SAIIER indicated that 'these programs take place as and when resource persons are available. It is a continuous need and not a development priority.'⁶⁹⁹ Our albeit limited interactions with those involved in the sector indicated otherwise, with the relatively unstructured supply of training falling short of the demand – at any rate, securing well-established modules for teacher training will be necessary in anticipation of future growth, as also to serve SAIIER's ideal to extend services beyond Auroville to the country at large, where limited work has been done historically. Prof. Joshi's voluminous edited works in this field on historical figures of note,⁷⁰⁰ and in particular, the Curriculum Handbook for the Indian Institute of Teacher Education (a detailed and brilliant volume) may be explored as blueprints for this exercise.⁷⁰¹ The need and demand for such programmes across the country, particularly with the push of the National Education Policy, makes it an opportune moment to begin that exercise. This will require the systematic development of a dedicated training infrastructure / strengthening of the Teacher's Centre.

In this, SAIIER may consider introducing a Bachelor of Education for the free progress system (proposed by Professor Joshi to the 2001 Visiting Committee), along with vocational courses in integral education, certified apprenticeships, hybrid distance education courses, MOOCs, for short-medium term assignments, through Pondicherry University and any other aligned institution, given the renewed focus of the National Education Policy on capacity building with a 4-year integrated B.Ed. programme. SAIIER's institutional placement, and the knowledge generated through experiments over the years, places Auroville well to lead this movement. Aside from the educational and research benefits of such programmes, they can leverage the economic potential of Auroville's education sector, which is an urgent concern given over-dependence on Plan Grants / donations, and limited surplus within Auroville (which we are informed has led the Budget Coordination Committee to request schools to cut-back in the last cycle of discussions in May, 2023).

⁶⁹⁸ See, for example, Professor Joshi's account. Joshi, 'A Brief on the Sri Aurobindo International Institute of Educational Research', n.d. 4-5.

⁶⁹⁹ Ayer et. al., 2019, 36-8.

⁷⁰⁰ Joshi, 'Teachers Training Catalogue', n.d.

⁷⁰¹ Joshi et. al., 'Curriculum Handbook, Indian Institute of Teacher Education', n.d. In general, SAIIER may consider in-print publishing of Prof. Joshi's complete works.

Finally, in addition to capacity building in terms of teacher training, there appears to be a need for capacity building in relation to administrative / managerial functions – Ayer. et. al. record the concern that ‘responsibility of school management and administration (is) delegated to teachers without prior training and capacity building.’ Interviews in the sector, albeit limited, confirm this view, with teachers suggesting that they are over-burdened and under-prepared / resourced to handle school management. Aside from managerial inefficiencies that result, the research suggests a significant link between school management practices and learning outcomes.⁷⁰² Whilst naturally school management is to operate at the level of each school, with freedom to self-organize, the following suggestions may be considered: (i) a principal / senior teacher / school manager’s forum to addresses organizational challenges together, attempted successfully for example in the CreatNet Principal’s Forum in New Delhi, (ii) continuous capacity building / school management training for principals / teachers on request, organized by SAIIER with internal leads or experts / consultants involved leading schools elsewhere, (iii) a centralized learning management system (‘LMS’), developed by SAIIER, to ease the burden of academic administration, which we discuss below; (iv) with consultations on further areas of common concern across schools that can be helpfully centralized or addressed through collective measures through the proposed Auroville Teacher’s Forum.

f. Strengthening Planning, Peer-Review and Data Collection

In general, the planning and review functions for schooling in Auroville are variable, and in many cases, weak. As far as we are aware, no sector-wide development plans have been drawn up since 2012, with planning functions largely localized and informally conducted at the school level. As such, absent clearly articulated development goals, SAIIER’s planning and review function vis-à-vis infrastructure development is limited. The 2015 Auroville Retreat accordingly identified the creation of ‘an education coordinating platform’ as the ‘most critical challenge’. Equally, there seem to be limited independent review processes across the sector to assess educational outcomes (howsoever defined, not necessarily through examinations, and to the extent they are quantifiable), particularly in higher grades.

In interviews, we were met with uncertain assessments of the role of SAIIER in the organization of the educational sector – to the best of our understanding, SAIIER currently functions as a loose administrative umbrella within which Auroville and Outreach schools are housed, largely as a channel for funding and centralized school admissions. Going back, records indicate that SAIIER’s role was conceived as two-fold: research and planning / administration.

First, in relation to SAIIER’s role in anchoring research in Auroville in general: various proposals, including the 2001 Plan Grant Proposal and those at the 2015 Auroville Retreat, identify SAIIER as the nodal research body to develop and coordinate research in Auroville through consequent faculty clusters and centres. Yet, the founding documents for SAIIER, as indeed its current structuring, suggest a more limited mandate of educational research, rather

⁷⁰² JPAL, ‘Impact of School Leadership Training on Management Practices and Student Learning in India’, n.d. The findings naturally need to be investigated in the context of Auroville schools.

than research in general. There is, as of today, no established research agenda / identification of priority areas / research development plan pan-Auroville, within SAIIER or elsewhere – this is a gap that needs to be plugged, but Auroville may consider establishing an independent body for that purpose given the weight of the task, allowing SAIIER to focus on the task of pedagogical research in relation to the formal schooling system. The housing of the seven faculties identified in the 2001 Plan Grant Proposal, which find mention in subsequent SAIIER Annual Reports, including the latest one in 2022, may thus be re-considered (either re-constituted or re-housed) under an independent body, particularly as these faculties are not operational entities and seem to be listed for legacy administrative reasons. We consider this below.

The task of educational research in itself is a specialized discipline, which demands focused attention – clarifying SAIIER’s mandate accordingly may thus help streamlining work in that direction. Our discussion above on the Children’s University / independent research fellowships and projects housed at SAIIER relating to pedagogical research addresses the need for a systematic research agenda within this specialized domain: this would, *inter alia*, require: (i) organization of research clusters dedicated to themes *within* educational research (along the lines suggested by Professor Joshi, or otherwise in the vigorous literature on the subject), (ii) independent research-only fellowships housed at SAIIER, offered on a competitive basis within a defined funding allocation policy identified across priority areas (currently lacking) (iii) embedded projects within each school, through research-cum-teaching fellowships, with a funding policy to address priority areas (iv) a focus on research and publication, (v) a peer-review, assessment and feedback processes for each school to innovate on common challenge and for maintenance of minimum standards, where quantifiable and measurable; (vi) development of common handbooks, with curricular diversity; (vii) pan-school capacity building / teacher training measures through strengthening of the Teacher’s Centre; (viii) partnerships and exchanges with external universities, schools and research institutions; (ix) a city-wide digital learning management system, common across all schools, to organize learning materials and make them accessible and (x) organizing yearly or termly research conclaves, and instituting peer-reviewed journals in the field.

Second, in relation to planning / administration of the formal schooling sector, the following functions emerge:

- i. Pedagogical review, support and coordination:
 - a. develop active co-ordination and sharing amongst schools, with a common research output, particularly in relation to pedagogical experiments within the free-progress method, as discussed above for effective clustering.
 - b. provide independent peer-review and feedback to schools on curricula, methods and standards where deemed necessary (currently absent, to the best of our understanding, due to a reluctance on either side to ‘supervision’), particularly in relation to metrics that can be quantified or easily assessed (as indeed, various intangibles in relation to the practice of the integral education method may not

be open to quantification); and supporting schools with capacity development, where necessary; Ayer et. al. recorded a ‘lack of diversity in curriculum’ as a problem area in the sector – while we were not able to study curricula in detail, such peer-review processes, coupled with a public learning management system, discussed below, can allow curricular concerns to be addressed effectively and regularly. The absence of interchange between schools, and review processes with SAIER, currently insulates curricular development within schools with limited interchange. Finally, there appears to be a growing reflection across SAIER executives to broad base the teachings of integral education, with regular workshops on Sri Aurobindo’s and Mother’s works on education. A June 2023 survey conducted by SAIER on the relevance of the free progress method on teaching practices in schools, which resulted in relatively short but thoughtful responses, is an incipient move in this direction, and can be institutionalized through the Auroville Teacher’s Forum – a termly / yearly research conclave amongst schools to generate greater peer-review.

- c. address systemic challenges – these include concerns with drop-out rates (particularly in relation to Tamil students), catering to children with special needs, leveraging the sector’s funding potential, generating active links externally with schools and research organizations elsewhere, addressing optimal utilization of space, developing city-wide apprenticeship programmes, developing common research handbooks and developing research expansion plans for the sector in consultation with each school.
- ii. Infrastructure and funding:
 - a. Serve as the nodal body for school budgeting vis-à-vis the City Services Fund. SAIER’s institutional role in the yearly budget discussions between Auroville school and the Budget Coordination Committee is not clearly defined – as we discuss in Part IV, a strengthening of zonal and sub-zonal systems would require financial assessment and disbursement decisions to be located within zonal bodies (SAIER for schooling), as a single-window to the Budget Coordination Committee. This would particularly be required as numbers grow, which will limit the possibility of individual discussions with units / schools. Processes to develop effective sub-zonal coordination between schools and SAIER, with the latter acting as a collective representative for the Budget Coordination Committee may be accordingly explored. This will in turn also create a more responsive interface between SAIER and the schools.
 - b. Developing common and beautiful physical infrastructure through a Detailed Development Plan for the Cultural Zone, particularly the Educational Loop, to avoid capital duplication, unplanned development and act as an aesthetically enlivening and closely-knit zone for learning. As we noted above, Mother in general was particularly enthusiastic for beautiful, cohesive and playful spaces

for children – the education loop offers wonderful aesthetic and architectural opportunities to make this happen. For example, Mother ‘is said to have very much liked’ the following idea in relation to the New Horizon project of the Sri Aurobindo International Unity Centre in 1956: ‘There is a small island in the lake, close to the shore, which will be transformed into an ‘Isle of Enchantment’, with ‘fairy-boat’ service from the shore and a legendary children’s paradise within its borders.’⁷⁰³ Her stewardship of Golconde in Pondicherry is another case in point. The current scattering of schools, and limited interchange, taken away from this ideal.

- c. In this SAIER may act as the sub-zonal link between the schools / pedagogical research centres and the TDC. A Development Plan for the Educational Loop is particularly necessary, given Ayer et. al.’s finding of capital investment duplication, and the 2017 TDC-TOR’s proposal for clustering of educational establishments for ‘convergence of appropriate land use plans and socioeconomic development.’⁷⁰⁴ *Ad hoc* expansion and development of schools introduced avoidable inefficiencies and sub-optimal utilization of resources, aside from denting the cohesive development of the education sector as a whole. Defined and as far as possible, digital, permissions / approval processes for infrastructure development can be instituted, for schools to identify requirements as against existing infrastructure / a Detailed Development Plan for the Educational Loop / Cultural Zone. This can avoid uncertainties pertaining to building approvals, as was the case with the 2014 proposal by the Last School. All subsequent approvals can thus be benchmarked against the development plan.
- d. Planning for new establishments and common spaces, activate funding channels (whether through a proposal for increased Plan Grants, or through private bodies) and leverage funding potential in the sector (through vocational courses / apprenticeships / distance education courses / hybrid programmes etc.). These activities require sectoral-wide planning and cannot be addressed exclusively at the school-level.
- e. Early five-year development proposals (from 1992-2007), including those in the Masterplan, focussed attention on expanding the schooling infrastructure to meet expected population growth – the slow rate of growth since 2000 has, it appears, dented this focus in subsequent proposals. In interviews, two concerns were highlighted: first, that expansion of educational facilities is not necessary, as newer residents will organically develop those facilities; second, that the small number of students (particularly in primary and high school, given low population numbers and drop-outs) did not allow Auroville to access benefits of

⁷⁰³ Guigan, 2018, Vol. 1, 57-8.

⁷⁰⁴ TDC, Terms of Reference, 2017, 2.3.7.

scale in terms of developing the necessary physical and research infrastructure, including plans for housing an Auroville Accreditation Board (which conversants in general welcomed). Ayer et. al. note on this point that excess capacity in Transition and Deepanam School (~50%) and Pre-Creche, Kindergarten, Nandanam and Aha, and Future School and Last School (~15-25%) is available – a ‘comparative evaluation of the built-up spaces of all the schools as in the year 2018 with the projected population for the next decade to 2028, shows that the available built-up space should be sufficient to absorb the needs for the next ten years.’ Whilst expansion thus is not required, this depends on the population growth rate, which as we discussed above, is a major concern in Auroville: Ayer et. al.’s projections, based on a 3.8% growth rate, may have to be revisited if appropriate strategies for a conservative estimate of 10-15% growth can be achieved. Indeed, the small number of students is a major concern for the development of the sector, as the scale does not justify necessary investments in physical and research infrastructure, limits experimentation and specialization – this concern was recognized by SAIIER in 2019, and voiced in interviews. As elsewhere, a critical mass of students and faculty is required.

Whilst naturally the variation and freedom of each school to determine its own management and methods is valuable, SAIIER’s centralized planning, coordinating and review function, with a yearly peer-review and feedback process, seems to require strengthening. This centralizing or consolidating impulse is necessary to allow for a systematic growth of the sector, and leverage individual activity currently operating in silos.

In particular, strengthening of SAIIER’s executive powers to develop and *implement* concrete five-year / yearly development plans, after due participation and consultation, is necessary – in this respect, SAIIER may consider (i) the development of 10-20% excess capacity in schools, to attract aligned residents (assuming higher than ordinary population growth rates, as suggested by the Governing Board), (ii) study utilization of existing educational spaces, with school-levels plans for development of under-utilized / single-use spaces; (iii) plans for the development of the Educational Sector Loop in the Cultural Zone, to allow for a concentrated, cohesive public space to generate greater interchange.

This point was addressed by the SAIIER Board in Ayer et. al.’s consultations, with the note that ‘it is helpful to identify priorities without excluding other projects and needs that were not planned for or foreseen ahead of time.’⁷⁰⁵ Whilst naturally plans cannot anticipate all future needs, and will need iterative development, the current state of affairs seems to be heavily skewed in the opposite direction with no Development Plan for the sector available as of today – our discussion in Part II on high frequency feedback-loops, with strong evidence-led planning, applies here in relation to balancing organic and planned development, a concern registered frequently in interviews on designing Auroville’s research future.

⁷⁰⁵ Ayer et. al., 2019, 24.

The need for concrete planning and strong executive powers needs some emphasis, as various proposals in relation to the education sector, in five-year development proposals till 2012 or more recently at the 2015 Auroville Retreat have, as in other sectors, been limited by the absence of clear assignment of responsibility and executive powers for implementation, particularly in relation to SAIER. As the facilitators for the ‘education track’ at the Retreat noted,

While ground realities and accompanying challenges and opportunities were easily identified, the resulting goals to concretize the vision are missing more specific elements of strategic planning ... there also appeared to be the tendency to remain in inclusive ‘vagueness’ to retain harmony and unanimity. Some underlying polarities within the collective, rooted in personal convictions and paradigms rarely surfaced and thus remained largely unaddressed.⁷⁰⁶

The proposals made at the 2015 Retreat were thus largely vague and undefined, with little by way of concrete proposals or follow-up processes.

Indeed, arriving at consensus proposals in this sector is easier said than done, as varying educational approaches each have their play in Auroville; yet a centralized approach is necessary for this sector (i) to generate a cohesive and mutually interactive pedagogical landscape across this diversity that benefits from reflective *peer*-review and can capture, collate and synthesize learnings across common challenges that may otherwise remain isolated, and (ii) to coordinate sector-wide development activity that goes beyond the domain of each school. As we discuss in Part IV, whilst participatory processes are key in the working of Sub-Zonal groups like SAIER, the absence of consensus need not unduly hinder forward movement.

This organizational reorientation will require:

- i. Strengthening SAIER’s institutional capacity, with appropriate plans to augment the human resource infrastructure to handle these tasks (given the SAIER Board’s remark in 2019 that human resource / managerial capacity to undertake new projects is limited).
- ii. Clarifying the distribution of responsibilities, with defined process maps, in relation to its functions in respect of each school, in terms of review, feedback and assessment processes, funding of new projects, expansion plans and budgeting.
- iii. Identifying areas of independent work, in relation to research fellowships or projects housed within SAIER, development of new schools / research centres / capacity building and teacher training initiatives.
- iv. Explicit and defined powers to plan and execute a common educational research infrastructure in the Cultural Zone by way of a Cultural Zone Development Plan, prepared along with the TDC and the Zonal Group (within which SAIER would operate, as a sub-zonal entity).

⁷⁰⁶ Full Report, Auroville Retreat, 2015, 40.

The last of these points merits attention, as interviews revealed uncertainty regarding the distribution of powers and responsibilities between various bodies – absent a clear articulation of who has powers to plan and implement, accountability mechanisms have been weak. Tellingly, the ‘most critical challenges’ identified at the Retreat were concerning organizational clarity, rather than substantive proposals: ‘someone to put the time in’, ‘finding someone to give permission’, ‘RA agreeing on vision’, ‘someone to take responsibility’.⁷⁰⁷ Of particular concern is the distinction between legislative and executive functions as between the Residents’ Assembly and TDC / SAIER – whilst the Residents’ Assembly is a legislative body that may consider the broad policy / vision, executive authority to develop and implement plans lies with the TDC and SAIER, who can and indeed are required to finalize plans after consultations / community engagement. As such, referring all issues back to the Residents’ Assembly is neither necessary nor efficient: as we propose in Part IV, the devolution of legislative responsibilities to the Cultural Zone Group (to be resuscitated) and executive responsibilities to the Working Groups, SAIER / TDC in this case, may be considered. The elementary concern of being unable to ‘find someone’ to take decisions – mentioned often during our interviews – is a sufficient reason to strengthen and clarify the relative distribution of powers across these actors for effective and time-bound implementation, particularly as repeated development proposals in relation to the education sector have witnessed a delayed implementation with piecemeal and unsystematic development resulting.

Finally, in relation to data collection, practices in the educational sector appear weak. In this context, we note the following:

- i. A sector wide Learning Management System / Education Dashboard to gather and update data on enrollments, drop-outs, demographic information, teacher profiles, personalized learning assessments / dedicated student pages, student records, collation of curricula, learning materials, community / parental / learner feedback, asynchronous modules for teacher training, etc. can be instituted to allow for efficient management – such LMS / dashboard systems are now commonplace in educational environments.⁷⁰⁸
- ii. A sector-wide utilization survey of existing and available facilities in each school is necessary to allow for effective planning – this can be digitized to a large extent as again is now common practice. The lack of sufficient data was recognized as an obstacle to planning in the 2015 Auroville Retreat, with a proposal to develop an ‘education resources database’ by 2015, yet the records are unclear if this exercise was conducted.
- iii. Recording of alumni feedback appears to be weak. A beginning in this regard was made in 2016 through a survey of alumni, which provided insights into the free-

⁷⁰⁷ Full Report, Auroville Retreat, 2015, 56.

⁷⁰⁸ See, for example, Turnbull et. al., 2020; Botha et. al., 2018. An adapted version of the DIKSHA (Digital Infrastructure for Knowledge Sharing) platform may also be considered as a template, for a bio-regional platform.

progress education’s effects on personality development, career choice and suggestions for improvement (including teacher training and emphasis on practical skills). However, the records are unclear as to whether this is a regular exercise or how the feedback is incorporated into the schooling system. This exercise can be automated post-graduation. Equally, an alumni database / platform – to allow regular contact between alumni and current students – may be considered.

g. Overdependence on Grants

Between 2011-23, SAIER received a total funding of Rs. 104 crores for the promotion of educational programs and research from external sources (Government of India grants, foreign funding (individual and institutional) and ‘SSR’ funding). SAIER received Government of India grants under general (recurring) and capital (non-recurring) heads to finance infrastructure development and curriculum/program design in Auroville schools. Foreign and ‘SSR’ donations have been channeled towards allied educational activities, beyond Auroville schools, such as for the Teacher’s Centre, the Supportive Learning Program for differently abled children, organization of nature camps, sports facilities, educational scholarships, child protective services and adult learning programs (Auroville Campus Initiative, Language Lab) etc. In this, Central Government Grants accounted for 63% of all donations.

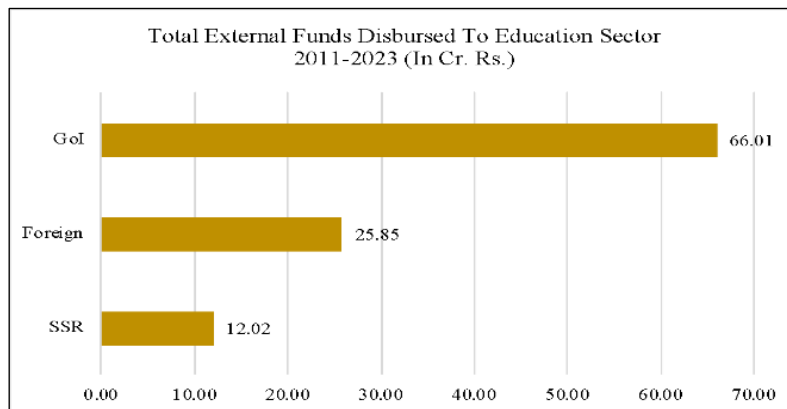

(Total external funds to the education sector, 2011-23. *Source:* Unity Fund)

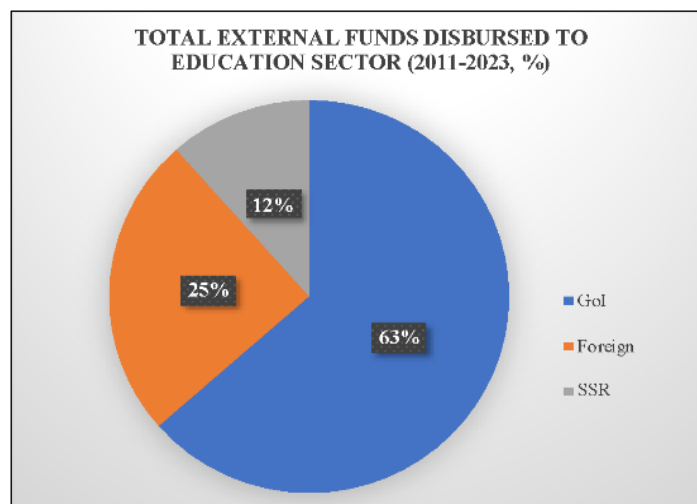

(Source-wise percentages for external funding, 2011-23. *Source:* Unity Fund)

The years 2015-16 and 2016-17 saw about a twofold increase in donations from Rs. 8 crores to Rs. 12 crores, but there has been a steady decline in total donations towards education and research activities 2017-18.

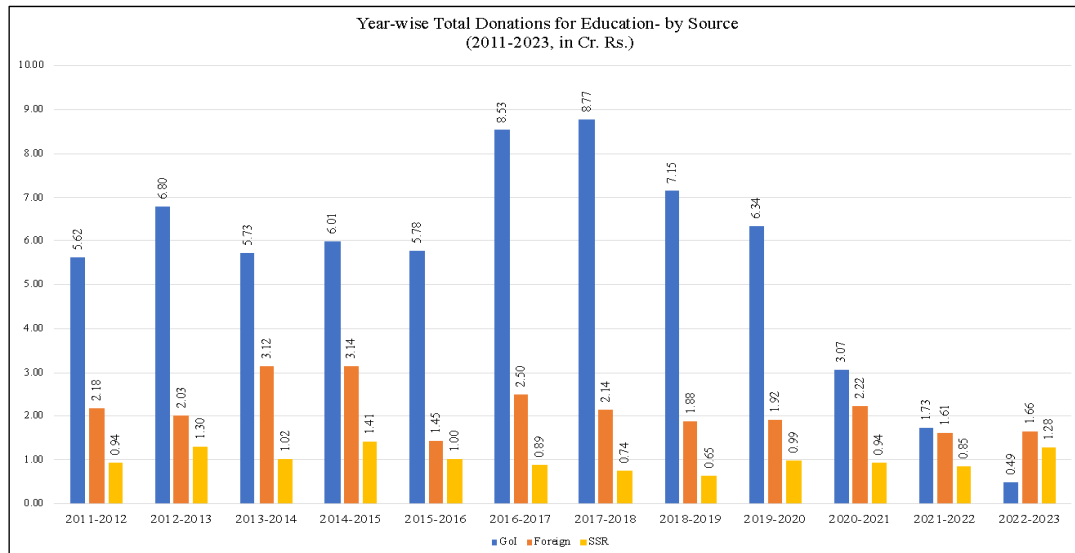

(Year-wise, source-wise donations / grants for education, 2011-23. *Source:* Unity Fund)

Further, a major portion of the grants received from the Government of India have supported recurring expenditure (maintenances etc.), rather than expansion or infrastructure. Comparing to education-related expenditure from the City Services Budget with foreign donations indicates an unhealthy dependence on foreign grants: for the last three years, 2019-20, 2020-21 and 2021-22, the figures, in crores, are 6.18 / 9.25, 3.07 / 6.23 and 1.73 / 3.43.

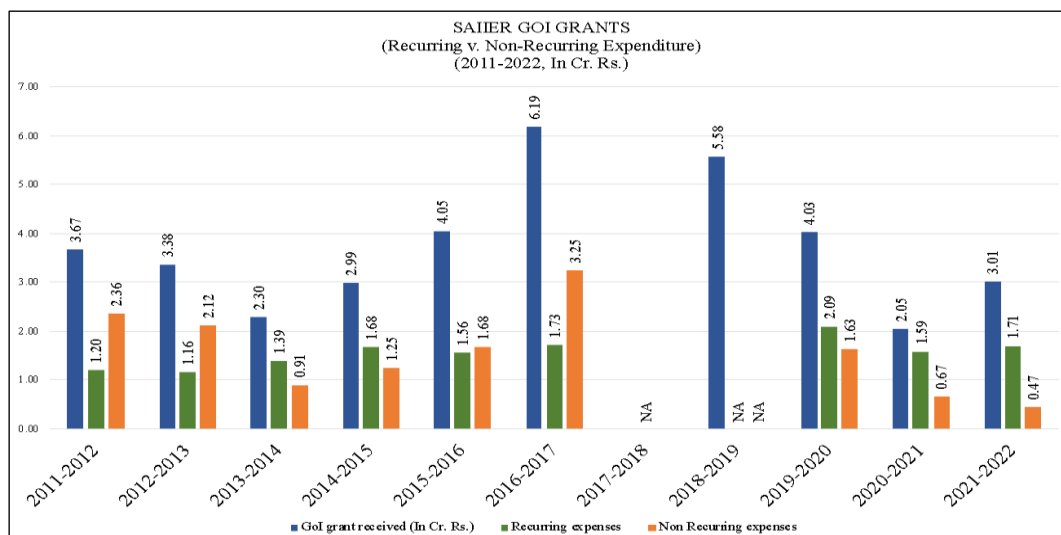

(Recurring versus non-recurring expenditure, 2011-22. *Source:* Unity Fund)

The over-dependence on external funding, particularly Government of India grants which have steadily and rapidly decreased since 2017-18, for recurring expenditure is concerning for the

medium to long-term financial health of the sector. The institutional risk of depending on external funding for daily operations must be weighed carefully. We may also note here that (to the best of our understanding) Government of India plan grants, starting with the 10th plan / Pande Visiting Committee Report, are given not as educational subsidies, but for educational research. This requires a conscious move to develop the research, publication and outward-facing extension activities mentioned above, including an Auroville Free-Progress Accreditation both for the continuing flow of Government grants and as importantly, generate revenues to minimize this dependence. Such work offers a meaningful path to revenue-generation, by educating others of Auroville's unique mission and developing much-needed 'free progress' teaching capacity in India. These may be bolstered by short-term apprenticeships, vocational courses and other offerings (as in the YouthLink Learning Network, Univers-City, Auroville Campus Initiatives etc.) to generate meaningful educational 'tourism.' As we consider in Part III.E below, the slow growth of the commercial sector and increasing demands of city services will likely put greater pressure for cut-backs in the education sector in the coming years, for which conscious policy planning along these lines may be considered.

That said, the Auroville schools currently underleverage fundraising potential in relation to ESG CSR grants.⁷⁰⁹ A common fundraising effort across schools, coordinated by SAIER, currently absent, carries significant possibilities to diversify grant funding, particularly for pedagogical research and extension work.

h. Development of a Tertiary Educational Sector: a living 'Univer-city'

Various proposals have been made over the years to develop a tertiary educational setup in Auroville, including but not limited to a university. In a sense, Mother's vision for Auroville was to develop a city that acts as a living university, where the progression from school to post-school education ties in seamlessly with community action. The Mother's naming of schools, beginning with Last School, through Super School, After School and lastly No School, reflects a vision to establish an *embedded* university framework – the challenge here is to ground these ideals materially in the development of Auroville through appropriate institutions of higher learning.

Historically, the emphasis on 'centres for higher knowledge' has been consistent since the 1969 Galaxy Plan which imagines a 'University of Peace' along with research centres in the Cultural and International Zones. Mother's vision for the Cultural and International Zones, outlined in Part II, was for an internationally diverse and multi-disciplinary research environment: 'to serve as a centre for education for those who wish to study the important contributions of the national genius in any of the fields of life's activities,' 'to serve as a research centre for the discovery of the Spirit of the nation.'⁷¹⁰ Her vision for the Sri Aurobindo International University, a precursor to Auroville – as the 'greatest seat of knowledge upon Earth' – and the Charter's commitment to Auroville as a city dedicated to research naturally yields to a tertiary

⁷⁰⁹ Auroville Foundation Annual Report, 2017-18, 26 records an exception, with a Rs. 1 crore grant from Bajaj.

⁷¹⁰ Jhaveri, 1974. This is a key element of Sri Aurobindo's socio-political thought, with a free confederation of 'nation-souls'. See, Sri Aurobindo, CWSA, 1997, Vol. 25.

university frame.⁷¹¹ Mother made this explicit, albeit in a lone reference, in 1969 in relation to a funding proposal to UNESCO:

The permanent university will be the key to Auroville's *raison d'être*. It must be a leap forward; so that it can hasten the advent of the future, of a world of harmony, beauty and union.⁷¹²

The following images, from the inauguration of the Sri Aurobindo International Centre for Education and the Convention for the Sri Aurobindo International University Centre serve to inspire to that ideal. The photo at the bottom, in particular, offers a symbol worth considering, with Mother surrounded by men and women of all ages and temperaments and a child innocently in the lead. Indeed, all her children.

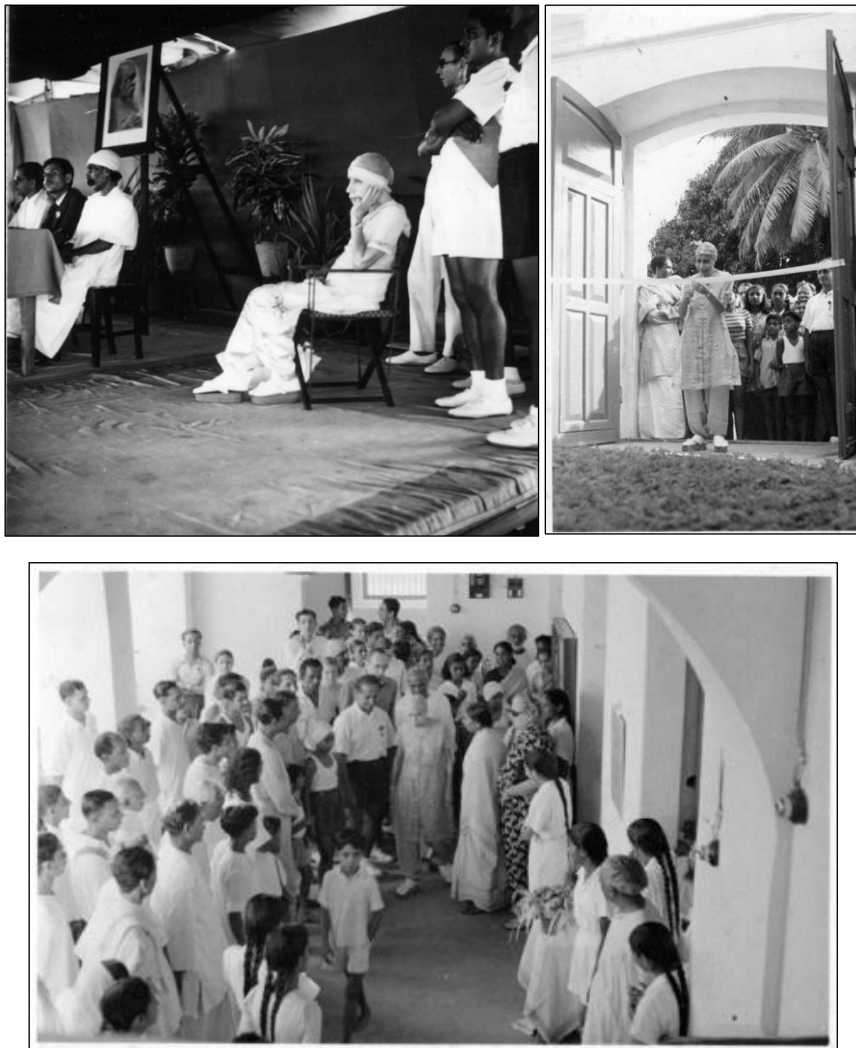

(Left: Convention for the Sri Aurobindo International University Centre, 24 April, 1951. Right and bottom: Inauguration of the Sri Aurobindo International Centre for Education, 6 January 1952. Source: Overman Foundation, 2017)

⁷¹¹ Guigan, 2018, Vol. 1, 45. Mother also references the 'University of Human Unity' here, though it is unclear if it is an independent project or the name for the 'permanent university'.

⁷¹² Guigan, 2018, Vol. 1, 325.

Through the early years, this imagination took the shape of the proposed Centre for International Research in Human Unity ('CIRHU'), to be housed in the International Zone as the focal point of research activity in the national pavilions, with a number of other centres – the Centre of Scientific Research, SAIIER, Savitri Bhavan, Auroville Language Lab, Agni Veda / Centre for Human Unity, Centre for Excellence in Sustainable Agriculture, Centre for Urban Research, Auroville Earth Institute and others – emerging independently, driven by individual enterprise and funding opportunities.

Yet, as far as we are aware, no proposal for the systematic development of a tertiary, research-intensive or teaching, university frame has been detailed out. Neither CIRHU nor the seven 'faculties of research' proposed in the 2001 SAIIER Plan Grant Proposal fructified. Similarly, the development and progress of the Super School and After School programmes (prioritized in the Visiting Committee's recommendations in 2001) is unclear. SAIIER's annual reports in the 2000s describe activities being conducted/proposed to be conducted as part of Super and After School at an informal, needs-based level and do not detail enrolment and drop-out rates. A 2021 SAIIER Brochure attempted to formalize the After School programme (offered to students who graduate from high school in Auroville (i.e., either from the Last School (free-progress / no certification), Future School (IGCSE/IAL-based program) or NESS (CBSE Board) – in this proposal, learning continues to be participatory and curriculum tailored to the needs of students, but with a 'certification ... issued by SAIIER at the end of the successful completion of the course of studies decided at the beginning of the course which will give details of what has been learned by the student.' The organization, status and uptake of this programme is unclear from the records. Notably, the Scholarship and Education Fund has also been started as a sub-unit of SAIIER to allow Auroville youth to pursue higher studies elsewhere through the provision of an interest-free loan to be repaid by students post completion of studies, though with a limited budget.

Another attempt at bridging the gap in tertiary education is the Auroville Gap Year Programme (a seven-month programme designed for Auroville youth to support their growth post schooling in Auroville) offered by the Auroville Campus Initiative, which is now the Department of Further Learning of SAIIER.⁷¹³ The Campus Initiative further comprises the 'Univers-city' platform that curates networks of domain experts/practitioners from within Auroville and elsewhere to mentor Auroville youth in their chosen fields of study through embedded 'learning labs.' While the range of offerings is currently limited, this is a notable effort to bring together the diversity of offerings in Auroville under one roof. As we note in Part III.E, the development of experiential learning programs as part of a tourism management framework can be considered, to both leverage economic benefits and sustain meaningful tourism that allows for Auroville to radiate its message to the world. We must also mention here the work of the YouthLink, formed as part of the community dialogue process at the 2015 Retreat, as a forum for peer engagement, in particular the recent Auroville Youth Integration Programme and the

⁷¹³ Auroville Foundation Annual Report, 2017-18, 26.

Auroville Learning Platform.⁷¹⁴ This is a wonderful platform to allow youth across the world to access Auroville for internships, volunteering and research that offers great promise.

In general, two considerations emerge in this space: the first is developing a research infrastructure in Auroville across major disciplines (humanities, social sciences, science, technology, engineering and mathematics, and medicine) and the second is catering to the educational needs of young Auroville residents' post-school along with the continuous or unending educational aspirations of the resident population. We address each in turn briefly.

i. Tertiary Research Landscape

On the first issue of a tertiary research landscape, the following points may be made.

First, the establishment of CIHRU, for which plans were prepared by Anger, and later expositions by Professor Joshi, has been long pending.⁷¹⁵ We are given to understand that work to establish the physical infrastructure is now in early stages, with two parcels of land pending acquisition. In regard to the latest proposal made available to us, the following points may be considered:

- i. The proposal requires further detailing of the funding requirements and research infrastructure, including details of full-time research positions and roles, disciplines to be housed at CIHRU.
- ii. In particular, details for the conditions of service, tenure, expected publication or research requirements and prior qualifications or experience for appointments require attention for the proposal to be feasible.
- iii. Given delays in execution, the proposal can identify time-bound action plans, with identified personnel requirements (internal and where necessary, external, with public recruitment calls) to enable a phased introduction of research and support staff. These are currently not included.
- iv. It would be helpful to map the division of research work in the current proposal across disciplinary lines, rather than subject-areas, for a clearer articulation of the methodological approach CIHRU intends to take to the problems of human unity. It is currently unclear if CIHRU intends to focus its energies on either the humanities, social sciences or STEM disciplines, or whether it is a multi-disciplinary institution, in which case an identification of research clusters within each discipline will be helpful to identify. Professor Joshi's detailed disciplinary

⁷¹⁴ See, YouthLink, 2022; Auroville Today, No. 407-8, June-July, 2023. Other similar events, for example, the Youth Day, are wonderful examples of how a thriving cultural landscape can be built. See, for example, Auroville Today, No. 410, September 2023.

⁷¹⁵ Joshi, 'Centre for International Research in Human Unity', n.d.

map may serve here as a useful template, which, to the best of our understanding, is not reflected in current proposals.⁷¹⁶

- v. CIHRU can consider instituting an external advisory board to help structure its research landscape. From our understanding, the CIHRU Board currently comprises internal members, whose research qualifications across disciplines may be limited.
- vi. To further promote exchange of ideas, CIHRU may also consider, identifying one or two core research questions of particular relevance to Auroville, identified by discipline (humanities, social sciences and STEM), within which faculty clusters can be identified from Auroville's *existing* researchers and centres, to allow for a cohesive organization of the research framework pan-Auroville. This can also be used to approach select universities to establish, for example, two research fellowships a year, with a clear publication requirement at the end. This can help generate a healthy and regular flow of medium-term researchers, which can bolster attempts to generate a healthy population growth rate. Importantly, a publication requirement will attract serious researchers and allow CIHRU to access external research funding usually available at leading universities, thus lessening the funding burden that we are given to understand is an obstacle. One academic conference per research cluster can be organized with this setup at the end of the fellowship as part of the Auroville Research Conclave (or howsoever named), that can result in an edited volume published by Auroville (or an academic press), to place Auroville on the research map, thus attracting those aligned with the vision.
- vii. Similarly, the research capacity of existing centres can be leveraged, such that the fellowships can be tied to a centre, for example, the Auroville Earth Building Institute, Centre for Scientific Research, Centre for Urban Studies, Auroville Botanical Gardens, various architectural offices etc., rather than building from a clean slate.
- viii. The link between CIHRU and the proposed university model, which we discuss below, will have to be clearly articulated to avoid redundancy and share organizational capacity.

Second, Mother's vision for Auroville as a living-university, with national pavilions in the International Zone and centres for higher learning in the Cultural Zone, across disciplines and cultures, requires a concerted effort to develop these zones. It is interesting to note that early planning, particularly in the 1969 'First Approach to the Town' study, linked the development of the International and Cultural Zones as the two 'poles for growth' for the 'realization of the town' and the 'urban complex':

⁷¹⁶ Joshi, 'Centre for International Research in Human Unity', n.d.

Realisation of the town starting from two poles

1st pole of growth :

The urban complex with a mainly international functions.

2nd pole of growth :

The urban complex with mainly university and research functions.

(Early Planning Approach. *Source*: Anger, 'First Approach to the Town, Plan of Study', 1969, 26)

The manifestation of the International Zone, as we discussed in Part III.A, has been rather limited compared to Mother's vision, with eight pavilions / clusters constructed, but none as yet with a permanent, living and robust exhibition of the genius of each culture, with attached research facilities (with the limited exceptions of the work of the Bharat Nivas, Tamil Heritage Centre and the Tibetan Pavilion). Mother's ideal an international university centre envisaged housing and facilities for research across cultures – particularly in the humanities – that would serve as a vibrant and well-endowed research environment, generating the necessary groundwork for a tertiary university. The Zone was originally envisioned as a place where students:

... will be taught in their own language ... the cultures of the various parts of the world will be represented here so as to be accessible to all, not merely intellectually in ideas, theories, principles and language, but also vitally in habits and customs, and in all its forms – painting, sculpture, music, architecture, decoration – and physically through natural scenery, dress, games, sports, industries and food.⁷¹⁷

If one compares the current state of affairs with the original vision, it is clear that the Zone is yet to mark a beginning. We have considered reasons for this under-development earlier in Part III.A, particularly in relation to the 2018 International Zone Strategic Plan – as Auroville's research landscape can only proceed co-terminus with the development of the International Zone, this requires urgent attention. It is necessary to develop (i) a time-bound strategy plan to approach embassies / foreign governments to build national pavilions, with coordinated, well-defined action between the International Zone Group (and sub-zonal national, continental clusters), the Working Committee and TDC; and (ii) identify leading universities globally across the continent clusters, to institute one / two-year in-residence research fellowships based in Auroville, with a defined research agenda, to generate momentum and access substantial higher educational funding available through international development programmes usually housed at leading universities for such work. In defining this agenda, the work of the Centre for Study of Civilizations, particularly the Project for the Study of Indian Science Philosophy and Culture, led by Professor Chattopadhyay, a former member of the Governing Board, may be considered as a blueprint for research activity across cultures / pavilions, to systematically harness the research potential of the International Zone. Space limits a more detailed discussion of this proposal, but the International Zone Group may identify a team of general editors, from within Auroville and leading scholars elsewhere, to lead such a project, approach leading academic presses in India to commission the project, and issue a global call for contributing

⁷¹⁷ Guigan, 2018, Vol. 2, 44.

authors. This would signal Auroville's research intentions and fillip a healthy inflow of scholars and artists.

Similarly, the systematic development of the Cultural Zone has lagged, with a limited research infrastructure across disciplines. As far as we are aware, no detailed development plan for the Cultural Zone, which would require a research agenda to identify disciplines / subject-areas to be represented in addition to the physical infrastructure, the focus of discussions historically, has been drafted till date. The development of each sector has largely been piecemeal, driven by individual enterprise of residents committed to particular causes, especially in schooling, but without an enabling environment to guide the overall development of the zone. This, it seems, is partly owing to funding and human resource constraints, but also, as conversants indicated, to a dilution of the original vision for those sectors as research environments and a reticence to planned development.

It is therefore urgent for each Zonal Group – assisted by the Research Group, discussed below – to develop a five-yearly *research agenda*, identifying research clusters, disciplines, priority subject-areas, along with requirements in terms of dedicated, qualified research fellows, strategies for inviting external scholars and developing talent within Auroville. The organic development of the sector, as several preferred, has it appears led to a dissipation of energies, which requires a centralizing corrective for integrated and planned development: the inevitable dynamic of collective development between these conflicting tendencies, outlined in Part II, currently leans heavily in one direction – accordingly, the 2015 Auroville Retreat identified coordination of research activities across a 'collective vision' are a priority area. The recent initiative by the Auroville Research Repository / Research Platform to collate research work and assist incoming researchers with navigating the landscape is a useful step in this direction, and one that requires systematic strengthening and expansion to develop a strong research infrastructure. Developing an Auroville Research Handbook may serve as a useful starting point in this exercise.

While review is not comprehensive, it appears that Auroville has a limited research infrastructure as of today, in terms of physical infrastructure, capital and human resources – for: (i) the natural sciences (basic sciences and applied technology, with the limited exceptions of the Centre for Scientific Research,⁷¹⁸ Auroville Consulting, Auroville Earth Institute, AIAT, Aurolec in the early years, and notable environment research and education work discussed above), (ii) engineering and mathematics, (iii) the humanities and arts (Savitri Bhavan, Agni Veda, Centre for Indian Culture, Auroville Language Lab, Centre for Research in the Performing Arts, Kalabhumi, Svaram serving as focal points), (iv) the social sciences (economics, sociology, history, political science, with the exception of the Social Science Research Centre playing a leading role) and (v) medical science research.⁷¹⁹ Indeed, Auroville

⁷¹⁸ For a review of the early pioneering work of the Centre for Scientific Research, *see*, Thomas and Thomas, 2013, 88-9. We are informed that the work of the Centre has since registered a relative decline. *See*, Auroville Foundation Annual Report, 2019-20, 41-2 for a summary of current projects.

⁷¹⁹ Whilst various individual volumes have been produced across a range of disciplines and subjects (though mostly in history, literature, social commentary), some acclaimed, we consider here the research infrastructure in general with a focus on peer-reviewed work. *See*, for a complete list of publications, *see* Auroville Art Service, 'Books written by Aurovilians and / or published in Auroville', 2017; Auroville Research Repository.

has played a leading role in research in discrete fields – land regeneration, ecology and forestry, architecture and building technologies, energy – consistent with the thrust of early individual efforts. Yet, a systematic and planned research infrastructure is now necessary, and indeed, possible given past efforts to develop a helpful foundation, to meet Auroville’s ideal – this is both to serve its immediate developmental goals through professionally trained residents – particularly in urban planning, medicine, engineering, business etc. – and the core task of knowledge generation.

It is unlikely that a research and training environment consistent with Mother’s ambition for Auroville – to be a ‘greatest seat of knowledge upon Earth’, ‘taking advantage of all discoveries from without and from within ... philosophical, spiritual, moral, scientific, all ...’ to ‘boldly spring towards future realisations’ – can develop through piecemeal individual effort.⁷²⁰ It requires substantial capital investment in physical infrastructure, funding sources for stipends / fellowships for researchers and a curated community of scholars. This is a task of considerable proportions that requires a detailed feasibility study, with the aid of external domain experts, for effective planning and implementation – this detailing is beyond our scope here, but at any rate, this will need a shift from the historical pattern of atomized initiative to a centralized push to systematically invest and build institutions that can attract aligned individuals. In interviews, some preferred an ‘organic’ approach, by which new residents will build these facilities as and when they arrive. Organicity and planning are not opposed here as we discussed in Part II – but past lessons suggest that prior investment is necessary at this stage to counter existing disincentives to dedicated and high-quality research work: the high cost of living, absence of newcomer housing / lack of accommodation for invited / visiting researchers, limited research facilities, particularly in technical domains that require large capital investment to begin, absence of specialized researchers in several fields, lack of defined research clusters, difficulty in identifying and tying into ongoing research and navigating the dispersed terrain, weak documentation practices etc. As such, prior investment and organization is required to invite aligned individuals. As Revi notes, ‘considerable pre-emptive investment in ... education and human development’ will be necessary to enable an innovation-led tertiary sector economy, which, as we consider in Part III.E, is the most promising driver for Auroville’s self-sustenance.⁷²¹ Lessons learnt from the cyclical stagnation in key sectors owing to the slow rate of population growth in the past two decades militates against a wait-and-build approach.

Third, we may note here that there appears to be an institutional gap – as of today, there is no nodal body to coordinate research activities in Auroville or to plan for future expansion. Whilst some have suggested that this lies within SAIER’s mandate, the founding document indicate that SAIER is *not* an institution dedicated to research at large, but rather to educational research. For example, the research ‘milestones’ considered at the 2015 Retreat were tasked to an undefined ‘sub-group of the Residents’ Assembly’, indicating the need for a dedicated and full-time body to develop the research landscape in Auroville, particularly in terms of identifying a comprehensive research agenda, funding opportunities, instituting fellowships, generating a positive footprint globally through strategic outreach etc. The recently developed

⁷²⁰ Guigan, 2018, Vol. 1, 45, 241.

⁷²¹ Revi, 2007, 8.

Auroville Research Platform (operated by three residents part-time, without maintenance support as we are given to understand) is a positive step in this direction to support incoming researchers and collate previous work. Yet, the planning function, to anchor and build a research infrastructure in Auroville, is yet unmet. This is a major gap, and serious action to address it would require substantial resources to be committed. Accordingly, we suggest that in the short term an independent and full-time body – a ‘Research Group’ or howsoever named – be constituted to anchor this important work, leading towards a tertiary research institution, a free progress university, in the medium term.

Fourth, in this context, Auroville may consider the establishment of a multi-disciplinary, free-progress research university. Sri Aurobindo and Mother both considered, at various points, in relation to Auroville and otherwise, a university ideal as a natural complement to their work.⁷²² The currently dispersed nature of research activities across Auroville can benefit from clustering dynamics. Naturally, this university ideal requires careful structuring to match Auroville’s unique context – whilst space limits a more detailed discussion, the following points may be considered:

- i. The existing research infrastructure across fields of expertise in architecture, ecology, sustainable building techniques etc. require organization into coherent clusters or collectives, with a single-window research platform, both to archive research and to invite external scholars.
- ii. These research clusters provide a natural platform to develop the university framework, rather than developing an *independent* university framework, which would be inefficient. As Auroville already has strong headwinds in this direction, with a founding vision uniquely suited to a tertiary university frame, internal research capacity developed in some sectors and an existing funding potential that can be leveraged within each centre, the ground-up development of existing expertise into a university frame presents a viable path for growth. In particular, the catalogue of courses and learning opportunities curated on the Auroville Education / Univers-city Platform, alongside the training and extension work conducted by various units, provide a well-established ramp for expansion into an embedded university scheme outlined below. Similar suggestions were made, we may note, at the 2015 Auroville Retreat, for ‘Auroville as a whole to be a university campus for education and researchers’, though at a fairly general level, without clear action plans.⁷²³
- iii. In this context, the challenge and unique opportunity in Auroville are not simply to develop a university, but rather innovate an *embedded* university model, outlined by Mother and Sri Aurobindo – a ‘university that was as large as life’.⁷²⁴ The university model that Auroville can experiment and develop is one where each discipline is naturally embedded in each sector of activity – research and education

⁷²² Guigan, 2018, Vol. 1, 38-9, 43-5.

⁷²³ Full Report, Auroville Retreat, 2015, 39.

⁷²⁴ Guigan, 2018, Vol. 1, 38.

thus do not operate as independent silos, but are integrated within the ‘city’. By way of an example, the School / Department of Ecology and Agriculture is embedded in the work of units / farms / stewards etc. in the Green Belt, the School / Department of Architecture and Urban Planning is embedded in the work of the Council of Architects or the urban planning processes housed in the TDC, the School / Department of Humanities is integrated in the various pavilions and centres across the International and Cultural Zones etc., which serve as constituent units. Whilst some centres may be independent of the university, others may be loosely affiliated and some housed within the university – a model of dual affiliation, to the faculty of the university and to the centre / unit concerned can be considered to develop an organic institutional link that does not limit the independence of each centre / unit and yet allows for the emergence of an embedded city-wide university model. Auroville’s founding ideal lends itself naturally to such an ideal, the ‘univers-city’ model. Indeed, it is here that Auroville can provide a unique contribution to the educational landscape. It is also worth noting that the faculties proposed in the 2001 Plant Grant Proposal broadly cohere to the traditional disciplinary distinctions between the humanities, social sciences, STEM and medicine, as opposed to the CIHRU proposal that is subject-specific – indeed, both can be explored, but at any rate, conceiving an embedded university frame will require careful thought to be paid to the appropriate disciplinary architecture.

- iv. Yet, manifesting this ideal requires an *independent* establishment, that can bind together the diverse elements of the city within a cohesive university frame that allows both for disciplinary specialization support by a critical mass of peers in the field and inter-disciplinary linkages naturally to Auroville’s community practice and ideal. Whilst the 2015 Retreat carries the suggestion that SAIER house Auroville’s research needs, and thus this university model, as was also the suggestion of the 2001 Plan Grant Proposal, it seems that SAIER’s founding ideal and current area of work is not research in general, but educational research.⁷²⁵ As such, allowing SAIER to maintain and develop capacity in this niche, rather than overlaying city-wide research development, whether in a university model or otherwise, on its limited institutional capacity, seems more appropriate. This would accordingly require an independent institution (the University of Auroville, or howsoever named) to be created for this purpose. Under Indian law, to be able to offer certification, whether for professional courses or otherwise, such a university would require an act of the Tamil Nadu State Legislature or the Parliament, to establish a university.
- v. Given Auroville’s focus on research, a phased introduction of doctoral and post-doctoral programmes and independent research (for those without formal qualifications) can be developed first, with relative ease, leading subsequently to

⁷²⁵ See, for example, Professor Joshi’s account. Joshi, ‘A Brief on the Sri Aurobindo International Institute of Educational Research’, n.d., 1-3.

graduate and under-graduate programmes. Indeed, these programmes will require careful pedagogical thinking, and an understanding of the regulatory environment within the University Grants Commission and professional bodies, to develop teaching and assessment methods suited to the free progress method as applied to higher education. Yet, the regulatory environment, particularly with the 2016 Graded Autonomy Guidelines and the recent push of the New Education Policy towards model liberal arts and multi-disciplinary institutions, offer sufficient flexibility to customize degree-programmes that can marry Auroville's ideal to the regulatory norms.

- vi. In any case, these downstream questions can be considered after an initial period of standalone research, and need not delay the first step in the natural evolution of the idea. We may also note here that the records indicate a proposal for a 'Liberal Arts College', discussed with the TDC in September 2015, but no movement on this is recorded since.⁷²⁶ We were not able to access details of this proposal, yet it may be useful to revisit the idea, particularly in relation to establishing an institution in the bio-region to serve the community, which dovetails with Auroville's own aspirations.
- vii. Given the urgent need in Auroville for professional expertise, in urban planning, medicine, engineering, accounting etc., for which regulatory accreditation is mandatory in India, a university frame will permit Auroville to develop capacity in-house in the long term, a gap in current policy planning.
- viii. The university can consider a mix of certified and non-certified programmes, with embedded technical and vocational education to leverage existing areas of expertise. Ayer et. al.'s suggestion of a 'Applied Research and Training Centre' to coordinate vocational training activities is timely, and can eventually be integrated into a university frame. A beginning has been made in this direction with the 2022 Memorandum of Understanding with Pondicherry University for students of the Auroville Institute of Applied Technology (AIAT) to obtain certificates for recognized courses of Bachelors of Vocational Training. Similar models may be considered in the interim for other vocational courses with Pondicherry University (particularly in relation to applied disciplines where Auroville has recognized expertise – for example, architecture, sustainable development, ecology, land regeneration, organic agriculture, energy systems management, free progress teacher training etc.) as a pathway to generate organizational knowledge for course structuring, until and if independent university-status is secured; indeed, the remarkable work of the AIAT in vocational education may be explored as a model for vocational training centres in the bio-region across other fields of immediate utility to the youth, in the form of integrated vocational centres outlined as a priority task in the 2015 Retreat.

⁷²⁶ See, News and Notes, September, 2015, 3.

- ix. A serious commitment to establish a university requires a major infrastructure push, particularly in capital-heavy disciplines such as medicine, science and technology; this will provide the necessary impetus to the development of these sectors in Auroville, and equally allow Auroville to access substantial private funding available in India and elsewhere for higher education. Auroville's funding potential in terms of research is currently under-leveraged, which a university model can help capture.
- x. Research, particularly in terms of scholarship, in the arts and humanities in Auroville is currently limited, both in relation to Mother and Sri Aurobindo's works, as also other traditions, spiritual ('Indian' and otherwise; in relation to the major Axial faiths or heterodox traditions) and temporal (particularly, the analytical and continental traditions, with which comparative dialogue presents meaningful avenues for research). Whilst there are notable study circles / individual initiatives run by residents, a research infrastructure to allow for dedicated research work is absent and unlikely to be generated at sufficient scale or quality without cohesive action – a university model, with the systematic development of research clusters and disciplines in clearly defined centres, operates not in opposition to existing initiatives but rather as a natural evolution. Indeed, several conversants indicated an indifference to 'traditional 'academic' work or intellectuality – whilst these concerns have force, they can be overstated. As we discussed in Part I, Sri Aurobindo's thought advocates a progressive transcendence of intellectuality, rather than a rejection of it. This subject requires a more detailed treatment than we can provide here, but in any case, the proposed university setup is agnostic on the methodological orientation that may be adopted in the content and substance of its research work – these conversations can be anchored within the university frame as part of its work, and need not delay its institution.
- xi. Developing a tertiary research environment in a university frame also presents a calibrated strategy to attract aligned newcomers – as we consider in Part IV, research exchanges with other universities and centres for research globally will naturally self-select individuals aligned to Auroville's ideals, whilst also ensuring a healthy interchange and critical feedback.
- xii. This proposal, if established through an act of Parliament or the State Legislature, can ensure that the governing authority remains within Auroville, thus alleviating concerns on that front. Auroville may also consider applying for the green-field Institution of Eminence status, as and when the window reopens.
- xiii. Finally, we note the difference in emphasis between the recent Multiversity proposal and this university frame. While the former focuses on establishing Auroville as the central node for free-progress research and education amongst the net of centres

globally, the multi-disciplinary university frame proposed here is a natural expression of Auroville's founding ideal in a suitable institutional frame: an embedded university. Indeed, the Multiversity proposal presents a valuable pathway to expanding Auroville's research sector and may be considered on its own merits: it establishes Auroville as the centre of free-progress and integral education experimentation, though governing authority, insofar as the proposed legislation made available to us indicates, is located in an independent body. In this, as a *via media*, Auroville may support and develop the *lead* centre of the proposed Multiversity to attract and anchor research talent in free progress education – yet, as it is formally independent of the Auroville Foundation, given Mother's guidance that exclusive control of management should not be handed over, constituent units / research centres / faculties can remain free to affiliate as a matter of independent institutional choice to balance concerns.

At any rate, examining the feasibility of this university model and its execution will require a well-resourced, full-time and empowered team, with external advice and input. While aligned ideas of an 'open university' were mooted at the 2015 Retreat, the absence of clear executive authority within any Working Group led to limited follow-up. If Auroville is to develop an embedded university frame as an expression of Mother's ideal for a living university, it must move fast and decisively to leverage strong headwinds in the sector with the 2020 National Education Policy. As Revi noted in 2006:

Excellence in education and research could be a key contribution of Auroville to India and the world. The implication of the establishment of world-class teaching and knowledge institution may need to be examined carefully, especially given the new thrust to public-private partnerships in this area. The challenge will be to build a bridge between inner and outer education ... This initiative, if adequately led, could bring considerable resources into the 'city' and help develop one of its four major sectors.

Fifth, as several conversants noted, Auroville currently has limited collaboration with industry – industry-linked research centres, in areas of electric vehicles, renewable energy generation, sustainable building and others where Auroville has demonstrated expertise, and in emerging areas, particularly artificial intelligence and machine learning, can be explored to invite external capital and kick-start research activity in discrete domains that may later be embedded into the university frame. This option may particularly be explored for the basic science and technology, where capital investments from internal revenue sources are unlikely in the short-term.

Sixth, pending a development plan for the Cultural and International Zones, developing interim housing for external researchers (at subsidized rates, with contributions made through research), particularly those invited by Auroville units or centres, is an urgent need. The cost of doing research in Auroville is currently steep, unless hosted by individual residents, which disincentivizes scholars interested in pursuing work in Auroville.

Seventh, to generate momentum, the Foundation – or the proposed Research Group – may consider developing an 'Auroville Global Fellows Programme' for external scholars engaged

in aligned research, for short to medium term work ending with publication or defined research outcomes. This is a practice common in leading research universities, which is suited for Auroville today. In addition, Auroville may consider the institution of dedicated fellowships for Studies in Sri Aurobindo and Mother for external and internal scholars (to be housed at Savitri Bhavan or elsewhere, as appropriate), to generate a body of scholarship across their *oeuvre* – these fellowships may be identified across works and disciplines, in philology, political philosophy and international relations, comparative theology, epistemology, philosophy of science, psychology, poetry across themes and traditions, dramatics, bearing on contemporary issues etc. to systematically generate comparative and quality research, which is a pressing need today and as far as our understanding goes, a gap in Auroville’s research landscape.

Eight, the Research Group may catalogue funding opportunities from recognized grant-making institution globally who regularly support university projects – for example, the Indian Institute of Advanced Studies, New India Foundation, Centre for Study in Social Sciences, the Ministry of Education’s Indian Knowledge Systems Program, Scientific Research Council Award, Ramanujan Fellowship, Wenner-Gren Foundation Grants, Wellcome Trust Fellowships, World Wildlife Federations Grants and several others – to assist early career researchers in Auroville in accessing those funds. To the best of our understanding, Auroville currently does not provide institutional support to access competitive grants – accordingly, a database of funding opportunities and timelines, with assistance in writing grant / conference proposals, will be a useful resource to assist young researchers. The assistance of established research universities / higher education consultants may be taken in this regard.

Ninth, the Entry Group / Research Group / SAIER may consider developing a targeted outreach campaign for universities and research institutions to invite early career researchers – our understanding, albeit anecdotal, is that Auroville’s image in universities across the world is not necessarily one of multi-disciplinary research (some exceptions aside, in agriculture, ecology and architecture). Whilst ‘publicity’ is to be conducted carefully, to avoid unchecked entries not aligned with the vision, Auroville’s founding ideal – as a city dedicated to research and learning – finds a natural home in the aspirations of university youth who may otherwise be unaware of the available opportunities, given partial reporting in popular media and the relative ‘hibernation’ of Auroville, as one conversant suggested, in international circles. As such, generating a positive global footprint as to the emerging research landscape in Auroville is an urgent task to help generate a healthy growth rate. In particular, the assistance of Auroville International Centres, foreign governments and existing linkages with individual units may be taken to identify aligned institutions for a targeted outreach campaign.

Tenth, as an immediate measure, Auroville may consider formal exchanges with allied research institutions within Pondicherry and elsewhere engaged in research on Mother and Sri Aurobindo’s works – for example, the recently instituted Chair on Sri Aurobindo Studies at Pondicherry University, the Indian Psychology Institute at Pondicherry, the Gnostic Centre in New Delhi, the Sri Aurobindo Centre for Advanced Research in Pondicherry (with whom a

Memorandum of Understanding has been pending since 2016),⁷²⁷ Institute of Human Studies in Hyderabad, the California Institute of Integral Studies, and the Ramakrishna Mission University. These can serve to build a shared research capacity amidst aligned institutions. Alongside, the syncretic spirit of the Sri Aurobindo and Mother's vision pushes for a strong comparative research framework – generating an exchange with other faith traditions, in departments of philosophy / religious studies / literature / Divinity schools or research-oriented monastic orders may accordingly be considered.⁷²⁸

Similarly, as we proposed in relation to CIHRU, the Research Group / the Foundation may consider programmes for formal exchange of faculty and research with leading universities in India and globally across disciplines, with a defined publication and / or research outcome, culminating in an edited volume / research conclave to generate short-term momentum leading to a university frame. For example, in India, memoranda of understanding with the Indian Institute of Science, Indian Institute of Advanced Studies, Indian Institutes of Technology, Indian Institutes of Management, National Centre for Biological Studies, National Law Universities, the literature faculty at Jadavpur University, the Indian Institute Human Settlements, liberal arts institutions such as Ashoka University, Krea University etc., tied into identified clusters / research areas within Auroville, may be explored where alignment is possible. As Revi rightly notes, the challenge here will be to avoid 'being captured by the deeply entrenched culture of mediocrity in the contemporary Indian bureaucracy and academia.'⁷²⁹ A similar suggestion was made by the International Advisory Council prior to the 2015 Auroville Retreat, to host a 'higher education conference to foster partnerships with universities and other institutions of higher education ... [and] to identify University Chancellors who would benefit from visiting Auroville with the potential of setting up partnerships and institutional collaboration'.⁷³⁰ The Council pointedly advised that 'rather than just being a 'show-and tell' of interesting projects, the gathering will serve as a catalyst for future partnerships and identify potential barriers to such collaborations' – accordingly, the Council proposed goals, target audience, outcomes and planning time-bound strategy, still relevant today and thus worth quoting at length:

Goals: 1) Develop long-term strategic and sustainable partnerships with universities and research institutions interested in innovative holistic forms of education; 2) Showcase and scale up unique aspects of the Auroville education experience, combining spiritual, social, and ecologically sound development of society; 3) Integrate Auroville more closely with the current need for innovation in the Indian higher education system.

Target audience: Select Vice Chancellors and education leaders from all parts of India, faculty members who have already developed partnerships with Auroville units, and appropriate members of the Auroville community who are engaged in this work.

⁷²⁷ Auroville Today, No. 406, May, 2023.

⁷²⁸ Space limits a listing of university departments / research institutions whose research aligns with Auroville's current focus areas – these can be explored.

⁷²⁹ Revi, 2007, 8.

⁷³⁰ International Advisory Council, Auroville Foundation, 2014, 3.

Outcome: Detailed mapping of all education related projects and identification of select projects with high impact and lasting impact; at least three to four concrete proposals for partnerships between Auroville units and universities over multiple years, strengthened commitment of Aurovilians who are interested in developing greater engagement with universities and research institutions.

Planning: We recommend that the Campus wide group of never-ending education take the lead in organizing this initiative with active involvement of members of IAC including Vishakha Desai, Shaunaka Rishi Das and Kabir Shaikh. We suggest that an initial concept note be sent to the Secretary Higher education about the conference before September. The planning should include a good mapping of all higher education work currently underway with a clear indication of partnerships, especially in India. The external scholars and faculty members who have already developed programs with Aurovilians should be consulted for their advice and for participation in the conference to articulate their observations and conclusions about their partnerships. Governing Board and IAC members can be consulted for their suggestions of potential participants. We propose that the final program should include presentations as well as visits to relevant units. There should be some time to experience Auroville. Thus, we believe that such a program should be for two full days. The members of the IAC are willing and ready to work along side the Campus group to develop this conference and to ensure its success. The IAC believes that both these proposals (Retreat and Education Conference) merit urgent consideration by all the stakeholders and would like early feedback from the Working Committee, Auroville Council, Vision Task Force and Campus Initiative on concrete steps and a proposed timeline.⁷³¹

The Retreat reiterated this proposal to ‘develop ... strong connections with ... universities’, by 2018.⁷³² Yet, to the best of our knowledge, this exercise was not conducted, and as such, may be considered today along the lines discussed in our short proposals above. There is a positive trend in this direction: ‘in recent times, there has been a growing trend of universities and other educational institutions carrying out regular learning engagements with Auroville’, with collaboration in the past with nineteen universities.⁷³³ While we were not able to access details of these exchanges or research outputs that have resulted, this movement can be strengthened and expanded across sectors, with a focus on tertiary research, in addition to internships, graduate theses and volunteer opportunities, which currently form the majority of engagements. The work of the Auroville Sustainability Initiative and Queen’s University, for example, demonstrate the benefits of such partnerships for Auroville, with a cross-flow of researchers that can generate a positive footprint, inviting aligned newcomers to Auroville. We may also note that substantial collaborations, training and consultancy services in land regeneration, ecology, sustainable building, architecture and the energy sector are recorded over the years with municipal authorities, community centres and universities – while space limits a more complete discussion, these notable works – conducted largely by individual units – can be

⁷³¹ International Advisory Council, 2014, 7-8.

⁷³² Full Report, Auroville Retreat, 2015, 39.

⁷³³ University Linkages, Auroville Education Platform, 2018.

strengthened for formal, regular research interchanges with research clusters alongside the extension or consultancy work.

Eleventh, the Research Group / Art Service may consider formal training programmes in the performing and fine arts. This may include in-residence students, from Auroville and elsewhere and full-time faculty, including visiting positions for recognized artists globally (or an artists-in-residence scheme), in a personalized, *gurukula* setting – across music, dance, painting, sculpture, drama, art history, aesthetics etc.⁷³⁴ As we noted above, Mother indicated that the Cultural Zone was an embodiment of the *mahalakshmi* aspect, which has a particular resonance with the arts. The ideal of his sector is encapsulated in Sri Aurobindo's alluring description:

There is no aspect of the Divine Shakti more attractive to the heart of embodied beings ... all turn with joy and longing to Mahalakshmi. For she throws the spell of the intoxicating sweetness of the Divine: to be close to her is a profound happiness and to feel her within the heart is to make existence a rapture and a marvel; grace and charm and tenderness flow out from her like light from the sun ...⁷³⁵

Interestingly, an early 1974 brochure for Auroville, presented by Jhaveri for the UNESCO General Conference in Paris, a wonderful historical artefact, envisaged that 'cultural pavilions' would 'arrange for the visit of their nation's great artists, scholars and leaders for the purpose of cultural and educational programmes and exchanges.'⁷³⁶ In terms of institutional strategy, the foundations laid by the Centre for Research in Performing Arts may be leveraged, leading in the medium-term to the establishment of full-time faculty clusters dedicated to each discipline. This will require a phased expansion plan with an empowered team to lead and develop the institution of these faculties. The scale and ambition of Mother's vision for the Cultural Zone as a vibrant centre of artistic activity, research and training will require substantial investment to establish the necessary physical and social infrastructure to establish Auroville as a leading centre for the arts in India. Funding opportunities in the arts are not insubstantial in India – these are currently under-leveraged in Auroville. The institution of formal training programmes will also allow for income generation to sustain the sector. Formal certification consistent with progressive teaching methods in these domains is relatively easier to secure and may be considered, either independently (leading up to an embedded multi-discipline university frame) or in affiliation with aligned teaching institutions, by way of partnerships and exchanges with leading schools of art / individual artists, as for example, Kalakshetra, National School of Drama, Film and Television Institute of India, Ramakrishna Mission Vidyamandir, Kala Bhavan, Visva Bharati University, the Indian Ensemble of the Berklee College of Music, Shantiniketan School of Fine Arts, Sir JJ Institute of Applied Art, Faculty of Fine Arts, MS University, Lashva Academy, the Dhrupad Sansthan and others.

⁷³⁴ See, for the importance of art to Mother and Sri Aurobindo's thought, Sri Aurobindo, CWSA, 1997, Vol. 20, 255-313; Vol. 1, 431-453; Vol. 25, 145; Mother, 1992. In 1969, Mother anticipated a music programme along these lines, currently run weekly as the Om Choir in Savitri Bhavan, 'It would be good to listen to music that comes from the consciousness of higher domains, straight from the upper level. I am in the process of preparing someone to execute it.' Guigan, 2018, Vol. 1, 325.

⁷³⁵ Sri Aurobindo, CWSA, 1997, Vol. 30-32, 20, 574.

⁷³⁶ Jhaveri, 1974, 19.

In general, a formal and regular exchange of artists, performers and academics across art and aesthetics departments in leading universities and performing centres, rather than simply a one-time invitation for a performance, will allow for a culture of artistic exchange necessary for a flourishing scene – on one hand, Auroville may benefit from external expertise in developing its own in-house research programmes, currently operating on a limited basis, and on the other, this platform may allow for greater visibility and recognition of Auroville’s own artists, to generate opportunities for collaboration, concerts and tours, generating in turn a positive footprint for Auroville.

Finally, in terms of medical science research, the establishment of a tertiary teaching and research hospital is an urgent need.⁷³⁷ Our review of the healthcare sector is incomplete, but the following issues may be noted:

- i. Anger’s 1965 proposal to the Mother highlighted the creation of health centres for outpatient health consultations based on varied treatment approaches from allopathy to ayurveda, naturopathy and homeopathy. Structured institutions for mental health treatment were also emphasized at the time with the creation of psychiatric centres. These health centres along with surgery and veterinary centres were proposed along the ‘Service Ring’ or Crown. Similarly, the 1988 Development Scheme presented a model for a multi-system primary health and dental care centre in the Residential Zone at an estimated cost of Rs. 4.5 crores, to promote ‘traditional, alternative and modern approaches to the treatment and prevention of diseases.’ Later, the Masterplan propose the creation of a five tiered health care infrastructure consisting of an Emergency Centre at the community level (serving a population of 250), a Clinic at the sector level (for a population of 1000), a Polyclinic at the neighbourhood level (5,000 population), a Hospital at the City/District level (for a population of 15,000) along with Alternative Health Facilities at the sector, neighbourhood and city/district level.⁷³⁸ The 2001 and 2005 Mobility Plans also accordingly made provision for the creation of health facilities in the secondary service node at the intersection of the outer ring road with the access road. Later plans, including the ISP-2009 and the IDPP-2013 highlight the need to foster capacity building (attract more health professionals and doctors to Auroville), promote health services and medical research and encourage entrepreneurial activity within Auroville to expand funding avenues and make available the latest medical and health technology along with specialized treatment facilities for Aurovilians and the bio-region. These plans have not systematically materialized, in lock step with concerns on the delayed implementation of the Masterplan discussed in Part III.A.

⁷³⁷ Mother had anticipated a hospital in relation to an ‘ideal city’ in 1954 (‘In the matter of health, there will be regular medical visits, a hospital, a dispensary, a nursing home ...’) Guigan, 2018, Vol. 1, 49.

⁷³⁸ Masterplan, 2001, 67.

- ii. The current setup of the secondary and tertiary healthcare infrastructure, and associated research, appears to be limited.⁷³⁹ The primary focus appears to be on primary healthcare, diagnostics, senior care, dental services, independent practitioners of alternate systems and psychiatric / counselling support, with the Health Centre established in 1972, Quiet Healing Centre in 1998, Kailash Clinic, the Santé / Auroville Institute of Integral Health in 2015, Ambulance / Emergency Services and Maatram, led by a team of dedicated and caring practitioners, though it appears without any centralized, strategic planning to guide development of the sector. A review of the healthcare facilities is beyond our scope here, but we note that referrals are thus common to the Pondicherry Institute of Medical Sciences, JIPMER, Aravind Eye Hospital and other regional hospitals, even for routine needs during holidays and off-times. Absent in-house education / training or research capacity (in medicine, dentistry, nursing or emergency / paramedical care), Auroville currently relies exclusively on resident professionals trained and accredited elsewhere.⁷⁴⁰

- iii. This is a major gap and opportunity for growth – an accredited multi-disciplinary teaching and research hospital, within the embedded university frame, across allopathy and AYUSH, may accordingly be considered with MMBS / BDS / BAMS / BHMS / BPT / B.VSc, BUMS / BSMS / BNYS options in line with early planning documents. The challenge here will be in examining and working with regulatory environments to generate learning consistent with Auroville’s ideals. Given limited internal capacity, we suspect Auroville will have to lean heavily on external support of those aligned with the vision to plan and execute a project of this scale and ambition, particularly with respect to the need for innovations in medical education signaled by recent reforms and anticipated in Mother and Sri Aurobindo’s short discussions on this point. A centralized set-up of this sort, if well-stewarded, can serve to (i) catalyze the growth of the sector, (ii) systematically plan and service healthcare needs for residents and the bio-region, and (iii) establish research facilities / faculties.

- iv. The viability of this project will depend on significant population increases, as the current scale does not permit or justify investments of this magnitude. A medical science research framework consistent with Auroville’s aspirations for cutting-edge research will require substantial prior investment, unlikely to come in the short-medium term from Auroville’s commercial sector. Accordingly, industry-linked

⁷³⁹ There are a total of 14 operational units in the Health and Healing Trust, comprising the Auroville Health Centre, Quiet Healing, Auroville Dental Care Education Research Programme – Rural Action, Auroville Dental Centre, Integral Health Service, Auroville Dental Laboratory, Auroville Health Services, Health Resources Management Unit, Multipurpose Health Centre (Bharat Nivas), Kailash Holistic Health Clinic, Child Protection Services, Santé, Auroville Home Health Services, Ambulance Service and Integrated Animal Care.

⁷⁴⁰ For a review of the sector with development priorities, *see*, Ayer et. al., 2019, 18-21. For a summary of ongoing activities, *see*, Auroville Foundation Annual Report, 2018-19, 39-42; *see also*, the case-study on the work of the Quiet Healing Centre in Thomas and Thomas, 2013, 175-8.

funding strategies for research centres (the practice in leading universities) and government funding for a nodal district teaching hospital will need to be explored.

- v. Given strong disincentives for tertiary healthcare professionals or researchers to join Auroville as of now, strategic outreach in university hospitals across the country, with an investment push to build first rather than wait for new residents to take the lead, seems necessary to attract aligned practitioners / researchers as newcomers.
- vi. In the short-term, the feasibility of the following programmes may be considered: (i) skill development and / or medical trainings for doctors / health professionals in collaboration with leading regional medical universities, JIPMER and CMC, Vellore (with whom preliminary discussions along these lines have been conducted in the past, in our understanding) and leading AYUSH centres across the country, (ii) a formal support programme for Auroville and Outreach school students under SAIIR / Health Board who wish to pursue medical education elsewhere; (iii) in-residence research fellowships for visiting scholars along identified research areas relevant to Auroville (for example, preventative medicine, epidemiological studies in the bio-region, commentaries on classical texts in Ayurveda, Siddha medicine, as areas that conversants indicated were of interest), (iv) an AYUSH history and practice research agenda / programme housed at the Auroville Institute of Integral Health, with a publication series and (v) AYUSH / other scheme empanelment to generate a patient and revenue stream.

j. Post-Graduation Options and Continuing Education

On the second issue of catering to the post-graduation educational needs of young residents and continuing education for residents, the following points emerge:

First, concerns with the absence of ‘formal structures of education’ for youth post-graduation has been repeatedly voiced, with Auroville unable to absorb youth interested in tertiary training across fields, professional or vocational. While there are no comprehensive surveys to judge the post-school trajectories of Auroville youth, anecdotally, the absence of professional training and a robust research frame inevitably skews young residents’ preferences after the age of 18.

Second, various initiatives have been taken to address this concern. The Stewardship for New Emergence project, a leadership development program (developed in 2017, though records do not indicate if it is currently operational), the Disha Information Desk, which provides personalized support to young Aurovilians for post-school pathways, the Unending Education group (comprising Savi, the Auroville Research Platform, Auroville Campus Initiative, Anveshan and YouthLink) and Purnam, an initiative focused on making Mother’s and Sri Aurobindo’s teachings accessible to Aurovilians and others (through curated learning programmes like the Integral Studies Programme), bridging the gap in education post-graduation from Auroville schools, with its flagship programmes Swadharma (‘a five-week ‘adventure of self-discovery in Auroville for young seekers across the world’) and the Auroville

Gap Year Programme (a seven-month programme designed for Auroville youth to support their growth post schooling in Auroville). There is alongside the ‘Univers-city’ initiative, which bears the potential to address two major challenges: building in-house capacities of Auroville youth and attracting (and orienting) younger newcomers to Auroville. These are notable works, with promise for future growth, that deserve support for systematic expansion. However, while such individual projects are encouraging, they are not substitutes for an institutionalized higher education system that can offer opportunities for tertiary training and research in the form of the embedded multi-disciplinary university proposal discussed above. Existing initiatives can serve as helpful building blocks to a more robust setup.

Fourth, as a complement, or in addition, to the embedded university model, Auroville may explore a city-wide embedded digital learning platform to curate learning, tutorship, mentorship and / or apprenticeship opportunities for the youth, who prefer to remain independent of a university frame – indeed, there are exciting opportunities to integrate this model *within* a university frame, with appropriate assessment models leading to certification.⁷⁴¹ The Mother’s enigmatic description of Auroville schools – beginning with Last School, through After School, Super School and No School – offers interesting possibilities to structure an innovative post-16/18 learning experience: as Tiwari perceptively notes, these names are to be understood not simply in their physical dimension, as names for school buildings, but rather, as states of psychological progression in the free progress method where a facilitative environment is created for the learner, ‘post schooling’, to identify, engage and train in her chosen areas of discipline by associating with the relevant unit / centre / sector of activity in Auroville. As Tiwari notes:

Mother saw Auroville as a learning society and each unit necessarily should be a learning environment. In the future we can envision that possibilities for apprenticeships and professional/skills training will be available in all units. Everyone will be then a teacher and a learner simultaneously and Auroville will indeed be the place, materially, psychologically and spiritually, of an unending education, a constant progress and a youth that never ages ... [for this ideal] a certain conscious analysis and rationalization still needs to be undertaken, but already each of these stages exists in practice.

This presents an interesting educational design problem, where Auroville’s embedded learning system, whether integrated into a free-progress university frame or otherwise, can experiment. Similar proposals have been floated over the years, most recently by Ayer et. al. for the establishment of ‘applied research and training centers’, ‘career counselling centre’ and a ‘collegiate composed of small-group tuition with tutor / supervisor for UG and PG levels.’⁷⁴² We are informed that SAIER, Last School and Future School have facilitated apprenticeships along these lines, but the uptake and consistency is variable.

This presents an exciting design problem: how can each unit / sector of activity in Auroville translate into a centre for tertiary learning and research? Developing an appropriate model will require a detailed study, but we sketch below a rough template for an undergraduate embedded

⁷⁴¹ Again, progressive assessment and certification methods can be integrated into the free progress method.

⁷⁴² Ayer et. al., 2019, 38-9.

learning model that may allow the ideal of unending education to be cast into an institutional form. This would comprise (i) a digital platform, with an integrated LMS, to identify the learning opportunities in each centre / unit / individual who wish to offer learning services, with course catalogue by discipline / area of work, (ii) with pedagogical support from SAIER / Research Group / independent, dedicated team for this model (depending on the organizational structure adopted) to develop a ‘course’ with appropriate curricula / learning and assessment strategies suitable to the nature of the activity, (iii) assigning one lead mentor / supervisor to assist the learner through the course of the self-curated program, possibly integrated with a Purnam / Integral Education Lab-format anchor group, (iv) identifying external tie-ups for areas in which Auroville does not yet possess expertise, (v) with termly / yearly monitoring, review and feedback by the appropriate group based on the unit and learner’s self-assessments, (vi) leading to an informal certification by each unit of the learner’s progress upon completion, (vii) tying into an ‘Auroville Credit System’, which may specify the necessary credits to be completed across chosen disciplines, with pre-defined course clustering / identification of pre-requisites as appropriate, flexible major / minor areas of study to allow a learner to develop her own learning catalogue within identified clusters for effective immersion and specialization, (viii) with appropriate credits (perhaps mandatory) for bio-region work / exchange with affiliated institutions outside (ix) ending with an appropriately designed Auroville Certificate (as opposed to a formal degree), and (x) subject to feasibility, stipends for students and appropriate incentives for units / individuals who participate.

Whilst this rough design template requires further examination, a city-wide continuous learning platform along these lines may be explored as a practical manifestation of Mother’s ideal of the After, Super and No School. We are informed that apprenticeship / tutorship practices were routine in Auroville’s early years, with a continuing but limited appeal today – as such, a firm architecture to anchor the diverse learning opportunities, particularly as numbers grow, with consequent distance and anonymity, can assist in rejuvenating and securing this cultural practice to progressively develop Auroville’s commitment to be a ‘learning society.’ The Auroville Campus Initiative, Purnam, apprenticeship opportunities at the Last School and the Auroville Campus Platform / Integral Education Portal, we may note, are innovative and exciting models working in this direction: while we were unable to study these initiatives in detail, they seem to offer the foundations for a city-wide platform that can serve, albeit partially, the post-graduation educational needs of the youth. Indeed, if established, such a model carries potential for integration into a multi-disciplinary free-progress university model.

Fifth, such a platform can address the needs of adult education, as much as of Auroville youth: Auroville’s ideal as a place of unending education requires appropriate means for hetero-didactic adult learners to be able to identify and engage opportunities for learning in new fields – whilst some individuals may be able to arrange for their own learning needs through appropriate contacts and / or exchanges, this network is likely limited by social location for many: a curated, digital city-wide continuous learning platform can (with or without the credit system) strengthen learning opportunities. In addition to offering a repository of learning opportunities, the platform, if actively managed may also host interactive, asynchronous digital content drawn from various units / sectors / events to allow for self-study, rather than a passive backend to allow user connections. Thus, for example, video lessons / updates / masterclasses

from the Farm Group / Auroville Board of Commerce / Town Development Council / Council of Architects / researchers in various fields can provide regular learning materials in agriculture / conservation, commerce and economy, urban planning, architecture, the researchers' fields of expertise for diffused and general consumption. Recent innovations in the educational technology sector can be explored as templates for this proposal. Aside from its learning advantages, such a digital platform can serve as a public space for social cohesion and camaraderie born of learning communities.⁷⁴³ This may support greater levels of trust and awareness, with downstream benefits vis-à-vis collective action and good governance practices particularly in relation to issues that have traditionally divided the community due to an insufficiently nuanced understanding of technical details. As we discuss in Part IV, insofar as concerns over informed participation in democratic processes in Auroville are concerned, with limited attendance of large public gatherings and information asymmetries, a continuous learning platform can generate stronger information flows for better decision-making. This was the founding principle of the Auroville Campus Initiative; similarly, the positive outcome, albeit with a limited sample size, of the Citizen's Assembly Pilot Project which provided participants with pre-recorded videos from domain experts, supports the need for a permanent city-wide platform to host such content, with asynchronous learning modules where appropriate. This would be, to the best of our knowledge, one of the first city-wide 'ed-tech' innovations, that may serve as an interesting experimental ground for collectives elsewhere.

*

⁷⁴³ Research on the dynamics of digital public spaces offers interesting possibilities for Auroville's own systems design. *See*, for example, Languillon-Aussel, 2021.

F. ECONOMY AND COMMERCE

Our review of this sector is brief given Thomas and Thomas' comprehensive work, which examines the evolution of Auroville's economy from the 1968 to 2013, with proposals for reform.⁷⁴⁴ As such, we limit ourselves to a short thematic summary of the guiding principles of Auroville's economy and its historical trajectory, to draw out persistent points of tension and identify development priorities.

i. Guiding Principles

Mother envisioned Auroville as a largely, though not entirely, self-sustaining city. As we discuss in Part I.C, Mother's ideal was a bold practical expression of the idea of Vedantic socialism – it rested on an arrangement of productive life (i) that is expressive, rather than transactional or competitive, as a ground for *karma* yoga, (ii) supports egalitarian access to basic public goods required for flourishing on a mutuality of need and capacity, (iii) generates a culture of material abundance, but not excess, based on innovation-led production, and (iv) replaces individual or communal property ownership, with stewardship in service of the Divine. While Mother and Sri Aurobindo criticized a sole preoccupation with economic growth ('the economic conception of life overrides all others'), for both its motivations (greed, envy, unchecked expansion of desire, wealth-linked status markers etc.) and effects (competitive social relations, hedonistic ethics, unchecked productivity / 'economic barbarism', instrumentalization of knowledge and beauty, untethering of work from value, industrial and bureaucratic unfreedoms, environmental damage etc.),⁷⁴⁵ their vision was neither ascetic nor distrustful of capital.

Indeed, Sri Aurobindo recognized the necessity and value of global industrial growth driven by an engine of technology-led production, to democratize access to basic necessities and improve the standard of living, balance political power across 'conventional' classes and expand access to practical, scientific education, as a (perhaps ugly and rough, but powerful) means to universalize spiritual pursuits in time. This echoes concerns raised subsequently in a growing body of literature revisiting the ethical foundations of economic growth, productivity increases and the future of work, reimagining the economy a means to an end, that of human flourishing, not an end in itself.⁷⁴⁶

Accordingly, Mother's founding concern for Auroville was to generate and sustain a sufficiently strong productive base to secure material necessities and a certain level of comfort or standard of living, alongside appropriate surplus for growth for a rich, urban environment (investment in infrastructure development), which would in turn allow each to focus their energies on the spiritual pursuit in the domain of one's choice in a modern city frame. Work, in this way, is ideally not a transactional necessity, a wage, but a means of expression, echoing indeed the ideal of a long tradition of thinkers reacting to the ills of alienation of value from

⁷⁴⁴ Thomas and Thomas, 2013.

⁷⁴⁵ Sri Aurobindo, CWSA, 1997, Vol. 25, 486.

⁷⁴⁶ See, for example, Skidelsky and Skidelsky, 2013; Skidelsky, 2020. This is a long-standing debate, with historical roots, an area for exciting comparative research in Auroville. See, for example, Rothchild, 2001.

labour in modern industrial setups. The unique import of Mother's ideal was the emphasis on *karma* yoga: work – including commercial work, the *vaishya* quality of production and distribution – as an offering to the Divine, a means to spiritual ascension, rather than competitive status-ordering or desire-driven consumption, as the organising principle of individual and collective life. She notes:

Money would be no more the sovereign lord. Individual value would have a greater importance than the value due to material wealth and financial position. Work would not be there as the means for gaining one's livelihood, it would be the means whereby to express oneself, develop one's capacities and possibilities, while doing at the same time service to the whole group, which on its side, would provide for each one's subsistence and for the field of his work.⁷⁴⁷

In this, for those drawn to it, commercial activity itself is the ground for *karma* yoga, for money to be 'reconquered for the Divine' – reconciling the intractable tension between 'business' and spiritual seeking.⁷⁴⁸ This vision – embodied in the Industrial Zone, a constituent pillar of the city – encouraged leveraging all possibilities and potentialities within and beyond Auroville, relating to businesses and industrial activities of all scales and types (cottage, medium/small and heavy industries), advancements in skill building, production technologies and systems of monetary exchange. Accordingly, for example, Mother's 1968 Ford Foundation letter proposes 'a town feasibility analysis' that would identify the 'types of industry, commerce, agriculture and other economic activities', on the basis of which, a 'preliminary economic plan' was to be prepared with 'inducements to attract specific economic activities (factories, stores etc.) ... to be determined'. As we discuss below, this systematic approach to economic development is, and has been, missing in Auroville, with piecemeal and variable development over the years driven by individual enterprise, often as a survival response.

This scheme – a practical attempt at a 'Vedantic socialism' – presents novel opportunities and problems. The challenge, as we noted in Part I, lies in concrete policy and practice specifications, not philosophical speculation. Mother's discussions on this point were at a high level of abstraction, and as such, require substantial fleshing out. For example, whilst she noted that Auroville will not have internal 'money relations', a point of constant emphasis in community dialogue since 1968, the practical import of this prescription is unclear – does it imply an internal, informal 'community currency', with a pegged exchanged rate? Does 'money relations' include any monetary exchange of currency or credit *per se*, or does it address long-standing concerns with inequity resulting from allocations through unregulated exchanges? Is the concern with the medium of exchange or the ethical implications of a *laissez-faire* approach? How does this 'no-money-exchange' proscription rest with her suggestion that those 'who have nothing but money will give money'? Similarly, when she suggested, 'each one will have to contribute to the collective welfare by his work, in kind or in money', a benign requirement of reciprocity, it does not address downstream concerns that require resolution: by what metrics will contributions be judged, particularly those in-kind? What administrative mechanisms can allow for individuated assessments at scale? How are free-riders to be

⁷⁴⁷ Mother, 1954, 1.

⁷⁴⁸ Sri Aurobindo, CWSA, 1997, Vol. 25, 248.

addressed? Again, in relation to the ‘prosperity ideal’, what is the commonly-agreed upon basket of essential needs in a modern city context? What consumer and ‘luxury’ products are to be produced or traded in Auroville’s marketplace? How does this interact with urban planning, in the Masterplan’s listing of shops, restaurants etc.? How can centralized, collective provisioning to ensure enterprise freedom and avoid levelling down? If collective provisioning is to be earned, by what metrics is this to be judged? What is a just distributive scheme that can secure ‘a happy and beautiful life for all’? Equally, in relation to the ideal of non-ownership enshrined in the Charter, how does this interact with motivations to work and innovate, or expand commercial enterprises, absent profit incentives? Does it require a transfer of all profits or turnover minus expenditure to a common pot? Are these voluntary or coerced? In which case, how does one resolve persistent efficiency and moral concerns with centralized planning, spending and permissions that hinder commercial freedom and innovation at scale? Can commercial units have variable incentive-linked maintenance packages? Does the diversity of lifestyles permit relative affluence for the ‘productive’ class as against the ‘service’ and ‘speculative’ classes? If so, how does communal solidarity interact with inequality? What levels of income equality are consistent with the ideal? Is qualified profit-generation permitted, proscribed or tolerated? Is Auroville’s ideal strict ‘egalitarian’, ‘prioritarian’ or ‘sufficientarian’? Is external equity or debt participation desirable or permitted? Similarly, how does the economic profile anticipated by Mother at the time evolve in relation to technological and productivity advances, tertiary sector developments and green manufacturing?

These are difficult questions – Mother outlined the guiding principles for Auroville’s economic setup, rather than fully articulated policy prescriptions. These are subject to varying interpretations and do not yield immediate solutions. The ‘famous question of money’, she noted, would only be solved by a collective with ‘an integral, comprehensive and universal vision’, a noble and notoriously hard ideal to practice that requires a great and as yet unachieved advance, including in Auroville, in developing one’s consciousness through the yoga.⁷⁴⁹ How must then the collective proceed in the interim, so as to avoid a disabling substitution of the good for the perfect? Sri Aurobindo following pungent remark has a particular bearing on Auroville today:

We cannot arrest our development of industry and commerce while waiting for a new commercial system to development or for beauty and art to reconquer the world.⁷⁵⁰

The emphasis of Mother’s yoga, both in philosophy and practice, distinguishes Auroville; yet, her principles are in a sense not new but eternal – they echo longstanding ideals that have proved intractable in collective experiments elsewhere, past and present, including in the ‘mainstream’, generating a vigorous literature with which Auroville can, but currently does not, meaningfully dialogue in its own systems design. Our discussion only touches upon these points – a more detailed discussion than is required to address the philosophical foundations and sociological implications of Mother and Sri Aurobindo’s thought on this subject. This is an under-researched area in Auroville insofar as published scholarship goes, with exciting

⁷⁴⁹ Guigan, 2018, Vol. 1, 271-4.

⁷⁵⁰ Sri Aurobindo, CWSA, 1997, Vol. 2, 248.

possibilities for future work.⁷⁵¹ Roughly, the practical concern is four-fold: (i) an enabling environment to attract, incubate and support commercial enterprises that can meet residents' essential needs, with sufficient surplus generation for city-building and public services, investment in research and the 'Prosperity' ideal, a form of basic in-kind income / welfare support scheme (adopted, in a different economic context, in the Sri Aurobindo Ashram), (ii) identification of appropriate regulatory mechanisms for just contribution and distribution schemes, consistent with the 'no-money-exchange', 'no-ownership' and 'prosperity' principles, (iii) developing pathways to maximum self-sustenance with strategic linkages with regional and global markets that may operate on a different logic and (iv) study and design on the future of work.⁷⁵²

In working with these ideals since 1968, Auroville's community dialogue and practice loosely tracks deep and long-standing debates on: (i) the conceptualization of money, as a medium of exchange or otherwise, (ii) moral limits of markets and exchange, (iii) institutionalizing and defining 'just' (re)distribution, through voluntary or coercive methods, (iv) preserving commercial freedom in a thick collectivist setting, (v) tethering of value to work, (vi) identification of appropriate scale, productivity levels and automation / labour-intensive activity, (vii) environmental and sustainability concerns with industrial growth, (viii) developing a commercial profile across primary, secondary and tertiary sectors to leverage specialization in a competitive global market, and (viii) pathways to a research-led tertiary sector, or a knowledge-economy.

Accordingly, in the brief reflections that follow, we frame the debate in Auroville in the canvass of the existing literature. A deeper examination – to take 'advantage of all discoveries' – is required to achieve a workable specification of Auroville's economic model, assisted ideally by a tertiary research infrastructure in economic and social policy. Whilst some study papers on point have been produced over the years, alongside Thomas and Thomas' seminal

⁷⁵¹ Our discussion in this part is limited. This orientation presents fertile ground for research with the vast literature in economic and moral philosophy and history, on the strengthening of individual enterprise, regulating competition, motivations to work, progressive contribution / 'taxation' systems, just distribution in market arrangements for allocation of surplus, appropriate regulatory interventions for structural inequalities, nurturing 'collective' or 'primary' goods and capabilities, nature of employment relations, etc. See, for example, Rothchild, 2001, for a historical perspective; Kincaid and Ross, 2009 for a comprehensive review. To the best of our understanding, work in this field, key for Auroville's policy design, is limited.

⁷⁵² The related concern of employment in the bio-region, *in situ* and for daily workers who come to Auroville, is critical as part of Auroville's commitment to integrated development. This is beyond the scope of our study. Sampathkumar, 2006 provided a blueprint for strategic planning for the work force, but action has been limited on this front. See also, Thomas and Thomas, 2013, 106-135 for a review; Auroville Today, No. 36, 2019; No. 366, 2020, for a short and insightful discussion on concerns with local employment, highlighting (i) the need for an employment, socio-economic survey, (ii) limited promotion opportunities in Auroville units for local villagers, (iii) need for skill-training and vocational education to address immediate economic concerns – '[the] last comprehensive survey of workers in Auroville was done in 2000. In that year there were 4179 employees and 3709 of these were surveyed, of whom 2971 were permanent employees and 738 were contract workers. Since then, apart from a more limited survey of institutional employees in commercial units in December, 2016, nobody has attempted to find out how many people come to work in Auroville every day. The figure of 5,000 has been bandied about for years, but nobody really knows ... The biggest challenge by far, 99.99%, is financial. And this is true not only of Auroville workers, but also of the villages today and also of a large cross-section of the residents of Auroville. Many of the people are living on the edge because they are in debt, some heavily. In 2000 life was still manageable, now it is a continual strain.'

contribution, much work remains to be done. Given limitations in internal capacity, collaborations with ‘external’ expertise will likely be needed and helpful.

The challenge will be to flesh out Mother’s brief prescriptions on the role of money exchange and production to arrive at a precise conceptual vocabulary that is sensitive to Auroville’s spiritual aspirations, yet not reductive, and one that is feasible at scale and in the context of Auroville’s inevitable external market links. Ethnographic work and surveys to determine prevailing views, with financial literacy programmes, may need to be designed to anchor these debates in an expert-led, informed community dialogue. Most important, however, will be the need for decisive action, given cyclical stagnation in the sector and a small-scale, labour-intensive commercial profile insufficient at present to serve the imperative of city-building and generate sufficient time and leisure for non-‘productive’ spiritual works. Auroville’s challenge is difficult, yet not entirely exceptional. Similar problems are faced elsewhere. If a workable arrangement of productive life sensitive to its ethical and spiritual aspirations can be developed, it would be a singularly valuable contribution to the global conversation. There is however some way to go.

ii. A Historical Sketch: Four Phases of Growth

The years since 1968 have seen experiments in building alternative economic systems (focussed on collective sharing and distribution, in the Pour Tous, Nandini, Circles and Seed initiatives, with variable uptake and success), the establishment of largely cottage-type industries, small to medium manufacturing units, consultancy services with some cutting-edge enterprises in electronics / computing in the early years, with the slow and piecemeal evolution of an organisational structure. Yet, major milestones remain to be crossed in creating a stable and flourishing economy, through the institutionalisation of strategic economic planning, capitalization of commercial units, generating lines of credit, stimulating of entrepreneurial capacities and entry policies to attract capital and talent. In this context, we consider patterns that have characterised the peculiar evolution of Auroville’s economy over the years. Patterns, which in many ways, continue to steer the direction of economic development in Auroville today. Our overview here leans heavily on Thomas and Thomas’ work, which identifies four phases in the evolution of Auroville’s economy.

a. First Phase: Subsistence Concerns

We keep our discussion of the first phase brief, as developments of the time have been recorded elsewhere.⁷⁵³ This ‘pioneering phase’ from 1968-80, with funds routed through the Sri Aurobindo Society, saw persistent survival concerns and a thriving idealism that led to an incipient commercial sector. Small population numbers and a sense of collective belonging led to various collective sharing models, notably the Pour Tous and later Envelops experiment. Basic necessities – ‘bed, bedding, mosquito net, toiletry items and clothing if necessary’ – were provided, a ‘monthly support fee’ was paid, with exceptions approved by the Mother if

⁷⁵³ See, for example, Thomas and Thomas, 64-73; Fanning, 2011.

necessary.⁷⁵⁴ Between 1975-77, ‘funding became ever tighter, and food supplied to the community members became increasingly spartan.’⁷⁵⁵ The financial concern persisted since the early days – for example, in November, 1970, Anger intimated Mother:

Besides, analysis shows in an obvious way that most of the practical difficulties are due to the chronic lack of funds. This situation, which is hampering any progress, has only gotten worse with the increasing number of Aurovilians. The lack of financial means makes it indeed impossible to build enough individual accommodations, and to provide Auroville with both a concrete economic infrastructure and an effective organisation.⁷⁵⁶

Early efforts relied in large part on individual savings and donations coming through the Sri Aurobindo Society, with small-scale agriculture to meet basic needs and an informal support system for goods and services, all with a sparsely-settled terrain of approximately twenty communities acclimatizing to the social climate and beginning the ambitious work of land regeneration. The developing conflict with the Society in the mid to late 70s imposed hardships in terms of food, housing and health, with an exodus of approximately 20% of the population. This led to the creation of small commercial units to meet immediate needs, more as a survival response than an economic strategy. Thomas and Thomas describe these attempts:

Definitely from an economic perspective, For All/Pour Tous has been the most characteristic institution that was shaped by individual initiative and ideological orientation on collective provision for individual needs (the ‘food basket’) as well as absence of money exchange (replaced by an account system). A key role of this institution also became its call for frequent meetings of the entire community to address numerous collective concerns ... As the conflict with the SAS intensified, there was a great urgency for residents of Auroville to start commercial units able to finance and sustain the collective economy, which in essence consisted of a system of distribution to provide for the basic needs of all members.

...

Between 1975 and 1977, funding became ever tighter, and food supplied to the community members became increasingly spartan. Moreover a pattern of borrowing by Pour Tous to meet the monthly basic needs led to shortfalls of the Pour Tous Fund in 1977. The sources available simply could not meet the needs.

A non-market system for distributing basic goods and service on an individualized level (owing to the small numbers, approximately 400 at the time), with a few small commercial units, led to a modest income but strong idealism, with a sense of collective belonging. A nascent organization developed, with the establishment of the Artisana Trust in 1978 and a Financial Committee, to plan for the community’s economic future. Budget deficits in the Pour Tous led to the second recorded experiment in collective sharing, the ‘Envelopes’ initiative – running from 1978 to 1984. ‘Envelopes’ dedicated to major needs across twelve budget heads were

⁷⁵⁴ Thomas and Thomas, 2013, 65.

⁷⁵⁵ Thomas and Thomas, 2013, 68.

⁷⁵⁶ Guigan, 2018, Vol. 2, 182.

created to streamline donations, maintain accounts and distribute as according to need. As with the Pour Tous, by 1984, this system ‘simply could not meet any more minimum community needs’. The idealism of the collective sharing model was met with productivity concerns:

In 1980, 11 out of 20 small enterprises focussed on handicrafts and two on clothing; two were sales outlets, called ‘boutiques’, one small farm, three in a vaguely defined category of ‘other’ and one was a rapidly developing firm in electronics [Aurelec]. Local markets were the exclusive outlets with the exception of one unit – called ‘Encens d’Auroville’ – which succeeded in exporting its handicrafts products. This development, as expected, reflected the available skills of the ‘labour force’ of Aurovilians and the dire need to earn ‘some more money’ ... These were mostly tiny informal enterprises, of which the unit holders pursued one overriding objective: to earn some moneys to sustain themselves and their immediate community.⁷⁵⁷

In economic jargon, productivity was too low to sustain a basic level of needs for the Auroville community. This meant that, both for the collective (public) development as well as for subsidizing maintenances for individual Aurovilians, the flow of funds throughout had become insufficient.⁷⁵⁸

Calls were accordingly made at this time for a ‘more professional’ handling of the incipient economy – a Financial Development Group was formed (though its relationship to the earlier Financial Committee is unclear in the archival records), with the aim of collecting financial data and establishing credit lines through an Auroville banking system. Partial relief came in the form of government funds to SAIIER, as we discussed in Part III.D, and a fresh collective sharing effort, though with a more limited ambition, in the form of ‘Nandini’. The handicrafts sector represented a majority of income generation at this time, organized under the Artisana Trust. With some forward movement, though limited success in terms of establishing an economic base, beset by the conflict with the Sri Aurobindo Society and slower than anticipated population growth, Thomas and Thomas suggest a shift to the second phase of Auroville’s economic development began from 1985 onwards, ‘the commercial phase’.

b. Second Phase: Economic Strengthening and Individualization

The second phase was a response to the failed experiments of the sharing economy, with greater individualization and new institutions. Productivity and income generation increased significantly, with records indicating dissatisfaction amongst a section of the population with a perceived abandonment of the ideal of a no-money-circulation economy as free and collective distribution was subject to monetary exchange. Thomas and Thomas describe this period:

Several industrial activities that had been initiated in the previous phases now developed substantially, and a commercial sector consisting of a large number of tiny units emerged. One may state that during a rather short span or time the very core of economic independence was established.⁷⁵⁹

⁷⁵⁷ Thomas and Thomas, 2013, 195, 223.

⁷⁵⁸ Thomas and Thomas, 2013, 73.

⁷⁵⁹ Thomas and Thomas, 2013, 78.

Between 1980-1990, 36 new units came up, with both capital strengthening and diversification – 30 units continued in handicrafts, clothing and ‘boutiques’, with 8 new units in architecture and construction and 6 in electronics. Alongside, units began substantial ‘exports’ outside Auroville. In particular, they record the work of Aurelec Data Processing Systems, a pioneer in the field of electronics, and Maroma, a handicrafts company that continues to be by some distance the largest contributor to the Auroville economy, as standard-setting companies able to achieve stable market links:

Aurelec ... broke ranks and paid Aurovilians ‘salaries’ instead of following the typical basic maintenance level. This company outpaced conventional economic development in Auroville, and did not conform to the economic standards of that decade. [The sale of the company subsequently, a significant loss to Auroville’s nascent economic system] provided adequate funds ... to establish a ‘Gateway Fund’ for Auroville, from which in subsequent years many Auroville projects were financed.⁷⁶⁰

The second commercial unit to overcome the ‘dis-economies’ of small scale was Maroma, pioneering in its professional export orientation in the handicrafts branch. The unit grew from the earlier ‘Encens d’Auroville’ into a remarkable enterprise with characteristics of excellent quality control and outstanding marketing skills for both Indian and foreign outlets.⁷⁶¹

With a ‘view to counterbalance the ominous tightening of resources’, this period saw the establishment of several small units in handicrafts, textiles, with Maroma in particular playing a dominant role in terms of revenue generation and contribution to the sustenance of the community’s needs. Most units at the time, however, had low turnovers and limited surplus for re-investment and growth or supporting infrastructure development for township activities. A notable advance was made however with a large proportion of residents being self-supported at the time. With economic strengthening, this phase saw increased construction in housing, and a modest, but still positive, growth in consumption wages led to improved standards of living. The energies at this time were primarily channelized towards the work of ecological restoration, the economic benefits of which are considerable if unquantifiable. Tensions however arose with calls for a de-monetization of the economy, with archival records replete with calls for an institutionalized collective sharing system. Notably, developments at this time are largely credited to individual enterprise, with no strategic plan for economic growth, external equity participation or banking. Thomas and Thomas note:

In a long-term perspective, the presence of some members with outstanding professional, entrepreneurial and managerial talents was remarkable and probably decisive for the subsequent development of Auroville’s economy, such as the start in those years of Auroville’s core enterprise Maroma, Aurelec Data Processing Systems, Aurogreen Farm and Pitchandikulam Forest, along with the construction of some remarkable architectural buildings. These ‘units’ did not provide immediate relief for

⁷⁶⁰ Thomas and Thomas, 2013, 79.

⁷⁶¹ Thomas and Thomas, 2013, 96.

the daily needs, but would later prove to be at the origin of Auroville's involvement in a wide range of economic activities.

The beginnings of an institutional structure emerged at this time, after 'a decade of dedicated but rather amateurish handling of collective finances.'⁷⁶² A Financial Group emerged for professional financial management, with the preparation of community budgets, and donations were pursued more systematically. However, as is the case till date, access to credit was limited, and insufficiently pursued, with proposals for a cooperative 'Auroville bank' not acted upon. Whilst Nandini continued, the Envelopes system, representative of the collective sharing ideal that operated, at least in the rhetorical currency of the time, in competition with the increased economic strengthening and individualization, was closed due to a shortage of funds, as was the case with the first Pour Tous experiment. The ideal of collective sharing came instead in the form of the 'Maintenances' system, a semi-wage for those rendering community services. Interestingly, despite solidarity concerns raised at the time, particularly in the late 80s, contributions appear to be high. Thomas and Thomas note:

Towards the end of the 1980s, Auroville had clearly outgrown its initial phases of experimentation with regard to collective needs. While the concept of voluntary contributions remained valid, an ethically binding guideline was adopted to transfer annual at least one-third of the previous year's total surplus, at the same time encouraging unit holders to decide on higher percentages. As a result, from 1992-93 onwards major increments in contributions are observed for a few years, which after a modest fall – even though with frequent fluctuations around a trend line – started to rise again. It is to be noted that contributions were made at a rate far higher than expected; however this was mainly from small and medium units.⁷⁶³

c. Third Phase: Institutionalization and Distribution

Greater institutionalization came in the third phase, in Thomas and Thomas' narrative, through the passage of the Auroville Foundation Act in 1988, with the establishment of the Funds and Asset Management Committee and the Finance Committee established under the Rules. This phase, of reflection and institution building', was characterized by a number of strategy papers, seminars and workshops, with the first detailed surveys of the economic landscape. Two concerns emerged at this time: a revival of the collective sharing system, in a no-money-economy and economic self-sufficiency. Coming on the back of the liberalization of the Indian economy in 1990, this was a fertile period for Auroville's economic growth, though by all estimates one with missed opportunities given an inward-looking attitude that did not engage with the new market opportunities. Thomas and Thomas describe the period in this way, identifying concerns raised at the time that are reflected in Auroville's economic thinking today:

With a growing membership and an increasing number of commercial units confronted with the liberalisation of India's economy, the old combination of strengthening the collective while endorsing individual freedom [the crucial dialectic

⁷⁶² Thomas and Thomas, 2013, 290.

⁷⁶³ Thomas and Thomas, 2013, 217.

in Sri Aurobindo's thought explored in Part I, and as we discuss below, in literature since] had to be re-invented.

More specifically, opinions on the basic elements of work, maintenance and access to free services were statistically verified. The aim of these surveys was to create a new and sustainable structure for an economic system that could count on the required input of working hours, on guaranteeing an acceptable level of living in terms of housing, food, clothing and other basic needs, and on generating sufficient resources to provide (and control) free or subsidized access to essential services.

To what extent could the community guarantee a maintenance allowance without demanding a minimum work input, and at the same time, offer free education, sports, health care, culture, etc? This process of soul-searching implied a focus on the internal dynamics and development of Auroville itself, rather than emphasizing the importance of wider outreach involvement.⁷⁶⁴

Three key developments came at this time, which in many ways continue to define Auroville's current setup.

First, turnover and export-driven growth increased owing to the liberalized economic environment. Exceptions aside, however, this growth was limited – a majority of the units were small enterprises, with a turnover less than five lakhs. Individual financial participation thus grew considerably in relative terms. This was sufficient for individual upkeep, investment in individual housing and consumption, but with limited potential for re-investment or investment in infrastructure development. However, a resistance to banking and credit, despite proposals for an Auroville Bank, impeded growth.

Second, a Central Fund was established in 1989 by the Economy Group (the fourth group as per our records, though the organizational structure between them is unclear), which provided a stable system of centralized accounts, along with a mandate for the Group to oversee financial matters. This allowed for regular monitoring, to identify and where possible, meet shortfalls in advance, signalling greater professionalism. However, the planning function – to identify strategies for growth of the sector – was conspicuously absent. Archival records from the time indicate, as Thomas and Thomas note as well, that the focus at the time was on developing appropriate regulatory mechanisms to identify the nature and level of maintenances to be offered for the growing social infrastructure – education, city services in particular, with 'relatively little attention' paid to growth strategies, particularly given problems of under-capitalization in Auroville's economy at the time. For example, the *Proposal from Aurovilians working Services to the Auroville Community*, discussed at the General Meeting on 1989, considered the question of maintenances for residents engaged in public work, but contained little by way of a feasibility study to see how the Industrial Zone could be organized around the existing commercial units to generate an adequate revenue stream. As Thomas and Thomas note, an inward-looking attitude, relatively disconnected from the economic developments in India or nearby Pondicherry, prevailed at the time:

⁷⁶⁴ Thomas and Thomas, 2013, 293.

In hindsight, it seems that Auroville during this decade need all its energy internally, and thus a rather inward-looking attitude is noticeable during these years ... Auroville itself had expanded substantially on the one hand, but also the one-time remote and dormant city of Pondicherry was booming, along with the liberalised economy of India. Probably a natural and somewhat defensive response during this decade led to a rather self-reflecting social and psychological atmosphere.

This was in contrast to the early years. A decade earlier the records still presented a visionary attitude to the entire production structure – including agriculture and industry – of the commercial domain and the need for its development, while the entire region to which Auroville belonged was seen as the framework for rural development of South India, and for the development of Auroville proper.⁷⁶⁵

Indeed, this orientation – towards an open, planned and ‘American-scale’ development of Auroville, with an emphasis on systematic industrial expansion – is distinct in Mother’s early stewardship of the project. The need for substantial capital infusion was on her agenda:

Small sums of money we have —to be precise: what the Government can loan, what people give to have a plot—it is coming. But it takes massive sums, you know, it takes billions to build a town!⁷⁶⁶

A range of proposals were made between 1980-1998 in this direction – our review is not complete, but Hemsell’s ‘Comprehensive Development Report’, the Development Group’s ‘Auroville Development Perspectives Report’, a comprehensive Village Survey in 1995 to identify development priorities and opportunities, Lamba’s ‘Auroville Bank’ proposal in 1997, with several other anonymous reports available in the Auroville Archives, speak to integrated development strategies. Yet the records indicate that these did not translate into any serious movement in terms of strategic planning. As a result, the growth of the commercial sector proceeded through individual initiative with predominantly labour-intensive, small units, without investments in anticipation of future industrial organization in the emerging competitive landscape. Individual financial participation grew, but structural concerns remained:

Over the years, the Central Fund grew considerably in size, scope and income. In fact, the growth of the Central Fund has been a reflection of Auroville’s overall development and expansion ... In February 1990, the Central Fund had a total monthly budget of Rs. 2.26 lakhs covering 24 services. In February 2003, the Central Fund distributed monthly Rs. 19 lakhs to more than 32 activities and services ... By February 2009, this had become Rs. 27 lakhs covering over 40 activities.⁷⁶⁷

Third, though calls for economic consolidation were made at the time, coordination and institutionalization of the commercial sector to leverage scale remained relatively weak. Archival records indicate that the Economy Group, later the Enlarged Economy Group and then the New Economy Group, focussed largely on the question of just distribution

⁷⁶⁵ Thomas and Thomas, 2013, 84-5

⁷⁶⁶ Guigan, 2018, Vol. 1, 114.

⁷⁶⁷ Thomas and Thomas, 2016, 86.

(maintenances, free provisioning of goods and services etc.), instead of investment or growth. The Finance and Asset Management Committee, operating under the direction of the newly-constituted Governing Board, played a relatively limited role at the time.

d. Fourth Phase: City-Development and Slow Growth

With this emerging dynamic came the fourth stage of Auroville's economic evolution in Thomas and Thomas' thematization – that of 'town development'. As we noted in Part III.A, the drafting of the Residents' Assembly Draft Masterplan in 1999 and the Perspective Masterplan in 2001 brought in a fresh wave of funding in city development and education, through Central Government Plan and non-Plan Grants and foreign institutional donations. Auroville's economic setup at the time was not equipped to meet funding requirements for the emerging need for collective housing, particularly for newcomers, and social infrastructure to meet the population growth and development targets in the Masterplan. While the Masterplan identified cost estimates in some detail, it did not, as a policy document, contain an economic growth plan to develop the commercial sector. That task remains till today.

Alongside, with the administrative umbrella of the Auroville Foundation taking shape and the growing complexity of Auroville's management, a piecemeal clarification of the operational mandate of the Funds and Asset Management Committee, the Budget Coordination Committee ('BCC') and the Auroville Board of Commerce ('ABC') came about, with a plethora of *ad hoc* committees constituted for discrete tasks, replacing the earlier Development Group, Economy Group, New / Enlarged Economy Groups, Finance Group, Finance Committee and Financial Development Group. The institution of a legal architecture introduced centralizing correctives in the organizational structure, resisted in the early years owing to fears of a 'government takeover' but with an increasing acceptance over time. The FAMC mandate now required it to grant permission for new commercial units and appoint managerial staff to monitor these units – historically, the Secretary issued Office Orders since May 14, 1992 'for the creation of new Units and appointing executives for the said undertakings to carry on for and on behalf of the Governing Board of the Auroville Foundation', but pursuant to the 'Agreement between Trusts and Units', approved by the Governing Board in its 45th Meeting in 2014, this practice was discontinued and delegated to the FAMC under Standing Order 10 of 2015.⁷⁶⁸ The ABC, as the zonal body in charge of the development of the Industrial Zone, represented the first attempt at coordinated economic development:

An important institutional shift at the time was the institution of the Auroville Board of Commerce, started in 1988-89 and later resumed in 1994-95 ... to optimise the growth of commercial units to allow for systematic strengthening of the sector. One intention of the commercial unit holders was to coordinate between themselves with respect to the needs of Auroville, Aurovilians and Auroville services. Several areas were singled out among a long list of priorities. Prob: ably most urgent, and less so for the larger units than for the smaller ones, was support and monitoring of a professional accountancy discipline. Another task of high priority was to advice the FAMC on granting permission for new commercial initiatives and appointing

⁷⁶⁸ Code of Conduct for all Trusts and Units of the Auroville Foundation, 2017, 1.

managerial staff to monitor these units from a community perspective. Regulatory and legislative advice — such as providing Provident Fund for the pensioning of employed workers — became another obvious area of building expertise.⁷⁶⁹

Notably, this growing, though confused, institutionalization across sectors (which we consider in Part IV) and a push for city-building focussed attention on the need for *planned* development, in contrast to the early years. As we discussed in Part III.A, the Masterplan led to a series of planning efforts aimed at a Detailed Development Plan. Whilst this was a stillborn attempt, the beginnings of an urban infrastructure began to emerge in this period, with the Visitor's Centre, Town Hall, Solar Kitchen, school buildings and research centres developed after the 2001 Pande Committee Report, along with healthcare facilities at Quiet Healing Centre, Santé and others, guest houses and collective housing projects (Citadines and others). However, as far as we are aware, no infrastructure push or draft Detailed Development Plan for the Industrial Zone that would house Auroville's commercial sector was drafted, indicating a relative indifference to the sector.⁷⁷⁰ As with the earlier phases, under-capitalization problems persisted in the economy, put now in sharp relief with emerging competition across India and in export markets. Thomas and Thomas note:

Surprising is the absence of an 'Auroville bank' or a strategic institution that aims at providing credit to tiny and small commercial units. From an economic perspective, one may safely state that the absence of some kind of 'banking institution' has led to a major shortage of funding for capital formation and investments. This, in turn, has had a very strong impact on the manner in which Auroville's economy has developed. Production of commercial units has been undercapitalised, or has become of a very labour-intensive character. With the impressive growth rates of the Indian economy in recent years, this must mean that Auroville's commercial units are bound to seek productivity advantages mainly in labour-intensive products and sectors. It looks like Auroville's commercial domain has suffered from what we may call under-institutionalisation.

...

There was definitely awareness of this institutional shortcoming. Yet, given legal complexities to establish some kind of (cooperative) bank, it is understandable that other than a modest 'Revolving Loan Fund' no strong financial institution was initiated.⁷⁷¹

One concern, central to Auroville's economic planning today, was the apparent obstacle in securing credit lines through normal banking or venture capital routes. Whilst the records indicate a general risk aversion to adopt this route, this was now compounded by legal obstacles under the AVF Act. We discuss this below. This led, in the period from 1998-2015, to a stark contrast between the development of Auroville's commercial sector, both in terms of capitalization and the share of labour-intensive activity and that of neighbouring regions or

⁷⁶⁹ Thomas and Thomas, 2013, 93.

⁷⁷⁰ An early development proposal in 1987, as a follow up to one in 1999, on the Industrial Zone is an exception, though records do not indicate any movement on it. Dhanya, 1987; Dhanya, 1999.

⁷⁷¹ Thomas and Thomas, 2013, 93, 105.

allied sectors in India that carried far higher rates of growth. The infusion of donations / grant funding in the urban development track (particularly housing, with a total Rs. 93 crores between 2011-2023) partially dented these concerns, but a lack of available capital for city-development remained a constant and unaddressed concern given the predominance of small units. A case in point is the aborted start to the Town Development Council's plan for a 114% population increase because of 'huge' short term budget deficits:

The projection shows clearly, that a large expansion in Auroville population, will create a huge deficit in budgets unless the commercial units are helped to dramatically increase their income and contributions. This would need a large and focused effort in assisting units, existing and new, on all levels also financially.⁷⁷²

It appears at this time that the relative emphasis on just distribution and collective sharing schemes, with a new 'Circles' experiment and later the Pour Tous Distribution Centre aspiring to institutionalize the 'prosperity ideal', was accompanied by a relative neglect of strategic planning of Auroville's industrial profile.

The Circles experiment – a collective pooling scheme – witnessed limited participation (about 20% of the population), and ran into losses by July 2000, unable to incorporate the 'lessons of earlier failures' of Pour Tous and Envelopes:

Financially, this social project was a tenuous operation. By July 2000, the average monthly deficit to be covered by the Central Fund on behalf of the circles [in essence, a collective bail-out by non-participating residents] was Rs. 23,000, with a projected future monthly deficit of Rs. 75,000 to Rs. 1,00,000 ... It was a minority who participated in this experiment, which in itself was ominous, as a critical mass is needed to build a stable collective system ... With an average monthly shortfall of Rs. 630 per circle and 66% of the accounts below zero, there was no escape from a financial collapse.⁷⁷³

Demographic data is unavailable, but the figures indicate that participants in the Circles experiment were on average drawn from residents without sufficient income sources to cover their expenses, whereas those with sufficient resources, either partially or fully self-supporting, chose to stay outside. It is unclear whether the reasons were institutional, motivational or otherwise. The aspiration for a collective sharing, non-money system was revived lastly in 2006 in the Pour Tous Distribution Centre ('PTDC'), operational today, for an in-kind distribution of basic needs tied to an honesty system.⁷⁷⁴ No individual accounting / expense-list is maintained, but usage is tracked to 'understand 'basic needs' and to discover a balance between over and under-use', with appropriate calls and requests for re-balancing as and when necessary.⁷⁷⁵ Clarence-Smith records the motivations behind the emergence of the PTDC:

⁷⁷² Town Development Council Development Plan, 2013-2014, 8.

⁷⁷³ Thomas and Thomas, 2013, 99.

⁷⁷⁴ The 'Seeds' initiative, run on similar lines of a pooling of resources, is discussed in Clarence-Smith, 2019, 213-8.

⁷⁷⁵ Thomas and Thomas, 2013, 100.

They [the PTDC team] felt compelled to do so because the existing institution, which had started out as a solidary common pot had devolved into an ordinary, profit-making shop, which they felt deeply disappointed by: ‘30 years to arrive to the point where we were just selling and buying to each other!’ one of the members exclaimed to me. While the existing Pour Tous was located in the current outskirts of the community, the new site was centrally located, in its ‘Service Area’: a complex of Services that included the community kitchen, ‘Solar Kitchen,’ ‘Nandini,’ a clothing and linens service, the ‘Free Store,’ and ‘ServiceLink,’ the central administrative hub of services. The PTDC group - composed of several members of the Auroville Board of Services - felt that the existing Pour Tous model would be incongruent with the ethos of these other Services, in addition to being incongruent with the socio-economic ideals of Auroville in general, and feared that: ‘[I]f we were not going to run this outlet as a community service without the exchange of money, because it was at the centre of Auroville, we could say goodbye to Auroville as a society without the exchange of money, where people are supported, they give what they can in terms of work and involvement and they receive what they need without exchange on money - which is what it’s supposed to be’.

It appears that a mark-up was charged at the time by Pour Tous (though the margin of profit or its utilization is unclear), which led to a review of its practices by the BCC and FAMC. The records do not indicate the outcome of this review. We may flag here the issue, recurrent in the records, of the precise specification of a ‘no-money-economy’, particularly as between a conflation between money as a medium of exchange, arguably consistent with Mother’s ideal, and the question of just distribution within a monetized system. We address this below in Section (iii-o).

Given the ethical imperative of collective sharing, a community-supported provisioning of basic needs was thus reinstated by the PTDC. Three concerns emerged at the time, leading to a General Meeting of the Residents’ Assembly in 2007: (i) the financial viability of collective provisioning, given the failure of Pour Tous, Envelopes and Circles earlier, which goes back to concerns with insufficient capital formation to sustain surplus generating growth; (ii) consensual participation in the PTDC implied that it must be self-supporting, without support from the Central Fund, which would amount to a subsidy from non-participating members; and (iii) problems with free-riders in an honesty-based system. The records do not indicate if any feasibility studies were conducted to address these points, but subsequent consultations and the General Meeting led to limited support by the BCC for the project, with a modest budget of Rs. 38,000. The PTDC thus operated as a cooperative sharing scheme, with a pooling of funds by participants, from which provisions are purchased externally or acquired through Auroville units, for ‘free’ consumption.

In this way, the PTDC serves the ‘prosperity ideal’, a universal social security / welfare scheme, with the community providing basic necessities: each participant makes monthly contributions as according to their needs (within three flexible slabs), with cross subsidies as far as possible. As we consider below, this is a noble attempt at securing Mother’s ‘prosperity ideal’ – however, it requires further specification in terms of the ‘no-money-exchange’ principle as the system is naturally sustained by monetary contributions and a linked exchange. In general, the self-

corrective mechanisms on which the PTDC operates – that require participants to monitor and evaluate their own usage patterns to render the collective provisioning sustainable – is notably high, with limited exits.⁷⁷⁶ As in collective sharing systems, or indeed, viable taxation systems in general, a self-correcting mechanism operates on an implicit understanding of reciprocity (if transactional ethical forms predominate in the community) or ‘limited’ altruism (if greater solidarity is engendered), if not more (a fraternal identification with the collective, which sustains voluntary contributions), if the system is to remain voluntary without coercive enforcement: the PTDC appears to have developed a settled practice on this point, within the limited basket of goods it currently services.⁷⁷⁷

Whilst further ethnographic work would be required to speak as to motivations, this is an advance on the earlier failed experiments, assisted by the high number of participants (unlike Circles), a modest, but steady, rise of the commercial sector generating greater consumption wages (as individual ‘contributions’ to the PTDC) and the provision of products at cost-price by some Auroville units. Concerns with scalability, free-riders and pathways to a more robust provisioning remain, aside from the broader issue of self-sustenance in respect of city-building / infrastructure development, which has been largely funded through external ‘services’ funding.⁷⁷⁸

Finally, in this fourth phase of Auroville’s economic sector, the system of ‘maintenances’ was instituted. This has attracted vigorous debate: maintenances are centrally supported funds – in cash and kind – granted to individual residents who are engaged in public services (education, healthcare, security, public service in the Working Groups etc.). Maintenance amounts are categorized according to work (City Service, Part-Time, Children, Student and Apprentice), and transferred to each residents’ Financial Services account, as *de facto* salaries (though not imagined to be transactional wages, but collective offering for contribution through work) which may in turn be exchanged for goods and services through internal transfers.⁷⁷⁹ In principle, maintenances are not wages for work rendered, but need-based community support: a resident contributing to the collective through work can request, but is not entitled to, support. Free-rider and inequity concerns naturally arise here. As Clarence-Smith notes:

This process is based on goodwill – the HRT [Human Resources Team, which evaluates these requests] does not formally investigate whether Aurovilians have extra-Auroville assets, bank accounts, or incomes. While some feel this information

⁷⁷⁶ Clarence-Smith, 2019, 231.

⁷⁷⁷ For a review, *see*, Clarence-Smith, 2019, 227-232; *see also*, Thomas and Thomas, 2013, 103 on variable contributions elsewhere (‘gradually it was no longer taboo to admit that some participants did not participate equally’),

⁷⁷⁸ *See*, Clarence-Smith, 2019, 238-241, for a discussion on the PTDC’s collective ethic, and similar voluntary cross-subsidies for collective provisioning in the Citadines and Sunship housing projects. *See also*, Auroville Today, No. 326, 2016. Further work on the demographic that chooses to participate in the PTDC experiments presents an interesting area for research, to correlate participation with age, nationality, term of residence, income-levels / nature of work.

⁷⁷⁹ Concerns are raised as to the practice of tying standard maintenances to work, which resembles a wage. Though this concern was raised in our interviews, alternate systems however have not been proposed formally, as far as we are aware. *See*, Clarence-Smith, 2019, 203-205, for concerns raised with the system of standard maintenances.

should be accessible to HRT, many Aurovilians are against this – in keeping with a culture of respecting the individual sphere within the collective, enacting Sri Aurobindo’s principle of spiritualised community ...⁷⁸⁰

Alongside, residents engaged in the commercial sector are paid maintenances directly by the commercial units at a limit of Rs. 20,000 per month, with city-service maintenances for those rendering non-income generating work. In practice, maintenances are negotiated between the BCC and various city-services through a yearly participatory-budgeting process (instituted in 20-21), to allocate available resources (through commercial unit contributions and grants / donations) based on (i) an assessment of need and relevance, generating a priority ordering of public services, and (ii) benchmarked against performance in the past year and projected outputs. The details of the collective budgeting exercise, instituted in 2020-21 to the best our understanding to generate greater community awareness and solicit input on development priorities, have been documented elsewhere.⁷⁸¹

Maintenances thus supplement the PTDC as a collective provisioning system, the ‘prosperity’ ideal insofar as residents engaged in non-income generating work are concerned. The growing demands of the service sector have outplacced the economy’s capacity to support them – contributions from the commercial sector (usually at 33% of profit under the Code of Conduct, which we discuss below) amounting to a modest Rs. 8 crores in 2020-21. Maintenance amounts have thus historically been low, approximating (and sometimes lesser than) minimum wage standards as per Tamil Nadu labour law (Rs. 18,700 as of 2022-23).

⁷⁸⁰ Clarence-Smith, 2019, 203.

⁷⁸¹ For details on the community budgeting process, *see*, Budget Coordination Committee, 2022-23.

Year	Cash	Kind (in cash)	Pour Tous (specified allocation)	Lunch (specified allocation)	Health (specified allocation)	Total
2007-2008	2000	3000	500	750	250	6500
2008-2009	2000	3000	500	780	265	6545
2009-2010	2000	3500	500	780	280	7060
2010-2011	2300	3500	500	780	280	7060
2010-2011	2300	3500	1000	860	280	7940
2011-2012	2500	3850	1100	850	300	8700
2012-2013	2500	4500	1200	850	300	9450
2013-2014	2900	5150	1200	1150	330	10730
2014-2015	3300	5150	1200	1300	400	11350
2015-2016	5000	5000	1200	1430	450	13080
2016-2017	5000	5000	1200	1570	450	13220
2017-2018	5500	5500	1700	1730	450	14880

Kind: cash for use within Auroville’s internal economy (between accounts of Auroville’s Financial Service). Pour Tous: community grocery service. Lunch: community kitchen lunch. Health: community health fund.

(Full-time Auroville City Service Maintenances: 2007-2008 to 2017-2018. *Source*: Clarence-Smith, 2019, 202)

Given shortfalls in the City Services fund, early records indicate that an informal dialogue with units was conducted to arrive at a workable contributions system. However, it appears that given persistent concerns with under-contribution and budget deficits, a 33% ‘contribution policy’ was introduced, for all commercial units. In general, the rising costs of city services and capital limitations in the commercial sector led to a regular back and forth at the time, though notably no proposals for capital strengthening / establishment of medium or large industry / high-skill services in the commercial sector seemed to have been considered to address the underlying systemic concern.

The FAMC and Working Committee subsequently introduced the 2017 ‘Code of Conduct for all Trusts and Units of the Auroville Foundation’ to extend this scheme to other income-generating enterprises. Appendix 2 – entitled Contribution Guidelines – codifies rules in this respect, with (i) a 33% minimum, mandatory contribution, subject to penalties, (ii) a Rs. 20,000 limit on maintenances to residents working at the unit, (iii) except for taxi services, eateries, plus other activities, learning activities and guest houses (1%, 5%, 5%, 5% and 20-25% of billing respectively), and a blanket exemption for municipal services, (iv) with deductions allowed for business expenditure, ‘wholly and necessarily occurred in the commission of the business.’ Records as of April, 2023 indicate that approximately 95% of commercial unit contributions by number, and 98% by value, adhere to these slabs strictly, thus effectively translating contributions into a *de facto* flat tax. This is in contrast to early records:

In the year 1989, the Economy Task Group also presented a Rs. 200 scheme as a monthly contribution to the Central Fund to be made by each Aurovilian or by the unit for which the Aurovilian works. It stressed the 'voluntary' nature of the scheme, and argued that it would be a contribution rather than a 'flat tax'.⁷⁸²

Compliance rates, in general, appear to be high, with units making additional in-kind or at-cost contributions to individual projects or the social sector. These are non-quantified, to the best of our understanding, but minimal. Clarence-Smith notes that the practice of specified contributions has 'by-and-large disappeared'.⁷⁸³ Anecdotally, others suggested in interviews that the practice was thriving. Clarifying the nature and extent of these contributions may be a useful exercise to weigh the comparative benefits of institutionalizing this practice, perhaps with an experimental regulated 'market' platform that allows for matching funding needs with contributions, with credits as against the 33% and shortfalls covered through the existing practice.

We were not able to locate any background document / study that speaks to the rationale for the mandatory, flat contribution rate, but interviews indicated that this was necessary on account of (i) budget deficits given variable contributions by commercial units prior, (ii) the need for city-wide accounting, and (iii) transparency in the working of the commercial units, insofar as declaration of profits, business expenditure etc. was concerned. The rationale behind the 33% rule has been questioned since, most recently by the Governing Board at its 57th meeting, on three counts.

First, some have argued that the sense of mutuality and camaraderie born of voluntary contributions prior to the policy has been dented. Clarence-Smith records this concern, that of the 'policing of economic solidarity':

The erasure of mutuality and reciprocity predicated by the bureaucratic deployment of the 33% contribution policy has been corrosive to the fostering and maintaining of a sense of community, eroding what one Commercial Unit executive said used to be the 'joy' of contribution, as well as undermining a feeling of fellowship between Unit executives and the BCC. This is not surprising given that the BCC carries out a 'policing' role, requesting the balance sheets of Units' to calculate the amounts due to the City Services, following up with people who have not contributed the full 33%.

However, BCC members are all too aware of the issues raised by the policy and its implementation - themselves bemoaning the fact that it compels them to act like 'tax collectors.' The following conversation, sparked by the topic of pending contributions, offers remarkable insight into how they reflect on and resist bureaucratisation to safeguard an 'Auroville spirit'.⁷⁸⁴

Second, some have noted that the mandatory 33% contributions disallow adequate reinvestment for growth of the units, thus affecting enterprise freedom and erecting entry

⁷⁸² Thomas and Thomas, 2013, 85.

⁷⁸³ Clarence-Smith, 2019, 193.

⁷⁸⁴ Clarence-Smith, 2019, 194.

barriers and disincentives for new enterprises and newcomers. Third, some have pointed to a tension with Mother's prescription that commercial units would contribute the entirety of their 'surplus profit' to the community, consistent with the principle of non-ownership enshrined in the Charter, which in effect renders the remainder *de facto* private income. In addition, concerns have been raised on the operation of the policy, with complaints of over-bureaucratization and heavy compliance requirements (for FAMC approval on loans, leases, transfer of assets, contracts, capital investments above specified limits and power of appointment of executives), deflection of income into private accounts / non-transparent accounting standards, inequities resulting from the flat rate with proposals for progressive slabs and from an exclusion of privately-held accounts / independent income-streams in determining contributions / maintenances, vague specification of deductibles in Appendix 3 and ineffective spending patterns from the City Service Fund, with proposals for direct, 'specified' funding from units directly into chosen sectors. Based on these concerns, calls have thus been made to restructure the system, but no draft policies have been tabled as far as we are aware. We briefly consider these concerns below in Section (iii).

Alongside, proposals have been made to cover the shortfall with alternate sources of income, by increasing the monthly contribution to reflect the true cost of living and leveraging income-generation in the services sector.⁷⁸⁵ On the second, Clarence-Smith notes:

In the mid 2000s, the Economy Group in charge of this budgeting exercise assessed the model of centrally-supported Services as financially onerous and inefficient, and encouraged a shift towards 'Self-Supporting Services' to address this. Self-Supporting Services were to operate in the same spirit as centrally-funded Services, in that they were to meet basic needs of Aurovilians on a cost-price, not-for-profit basis - but with no support from the City Services budget. They would have to push operational costs to users, something that partially-funded Services also must resort to, in order to stay afloat.

This was contested, as paid-for services were considered to be at odds with the collective / free provisioning of essential social services in the 'prosperity' ideal – though services were to be rendered at cost-price, without profit, the concern raised appears to be with a perceived contradiction between monetary exchange *ipso facto*, even at true or fair value, and collective solidarity.⁷⁸⁶ This issue reflected in the records going back to the Pour Tous, Envelopes and Circles experiments needs further examination: the necessary link between free provision and solidarity or fair monetary exchange and erosion of value is not apparent.

There are also feasibility concerns. We consider this below, but the concern, in a nutshell, is as follows: absent a stronger commercial setup which can support greater cross-subsidies and address the free-rider concern, this demand for paid-for services translates to an increase in contribution amounts – either voluntarily, which has historically not been the case, or coercively, which poses similar concerns for solidarity. The financial viability of this approach,

⁷⁸⁵ The 'services' sector in Auroville refers to activities relating to social and infrastructure development, not 'services' in the usual sense of a tertiary sector. *See*, Ayer et. al., 2019, 5.

⁷⁸⁶ *See*, Clarence-Smith, 2019, 197-200.

given existing pressures on insufficient capital for re-investment, is equally concerning. Tellingly, in this fourth phase, as earlier, strategic planning to strengthen commercial growth as a pathway to support city-service functions seems to have taken a backseat, with community debate revolving around the distributional questions of maintenances and contributions. As Thomas and Thomas note:

The issue of a basic income called maintenance has dominated economic discussions within Auroville for decades. Rather than a search for more cooperative models of production, the emphasis consistently was on patterns of distribution such as For All/Pour Tous, Envelopes, Nandini, Circles, etc. or the free provision of services and access to facilities. For instance, it took quite some effort to establish and, over the years, re-establish an Auroville Board of Commerce. Only weak objectives were formulated and little was achieved by way of common production and commercial orientation. It is very telling that discussions in Auroville mostly focussed on distribution and hardly on growth and efficiency.

As we consider below, the commercial sector, along with other income-generating sources (private contributions, returns on Financial Service investments, tourism revenue and income generating services), seem to have an insufficient ‘carrying capacity’ to support the vast catalogue of public services and infrastructure development (housing, prior investment in research and human resources development, in particular) required to attend to city-building, leading to cyclical stagnation.⁷⁸⁷ To the best of our understanding, financially viable alternatives to support free collective provisioning of services at the current scale were not proposed at the time. As a result, Rule 7(f) of the 2017 Code of Conduct requires services that support 50% or more of their recurring budget to contribute at par with commercial units.

iii. *Challenges and Development Priorities*

Given this short historical sketch of Auroville’s economic sector, we now identify challenges and development priorities. Our scope is limited – we frame Auroville’s concerns in the context of the existing literature, to point to areas for future policy research and action, with suggestions for discrete development tasks where possible. Many of these priorities have been identified in previous work, with problems lying in sectoral governance – an insufficiently defined institutional architecture preventing effective implementation through empowered and technically-qualified Working Groups – and a relative emphasis in policy-making on developing cashless distribution systems rather than strategic growth planning.

⁷⁸⁷ Thomas and Thomas, 2013; Town Development Council Annual Development Plan, 2014-15, 9; Ayer et. al., 2019.

a. *Undercapitalization of Commercial Units and Small-Scale Commercial Profile*

Thomas and Thomas’ review of Auroville’s economic performance from 1980-2008, supplemented by a review from 2008-15,⁷⁸⁸ indicates a steady increase in Gross Value Add (‘GVA’) by commercial units till 2015, with profitability steadily following post 1992 likely due to productivity increases and enhanced competition after India’s liberalization.⁷⁸⁹ In this period, the ratio of total surplus to Net Value Add (‘NVA’) has fallen from 58% to 34% between 1992-93 to 2007-8, with approximate figures shared with us as of May 2023 indicating a further decline along those rates – a matter of ‘much concern’, yet with no policy action since. The growth of the commercial sector is clear – the ‘aggregate available funds’ in 1980 amounted to Rs. 12,149 per capita, Rs. 1,04,544 in 1987-88, Rs. 1,34,014 in 1997-98 and Rs. 1,70,801 in 2007-8 (guestimate as of 2023 is approximately Rs. 2.2 lakhs).⁷⁹⁰ In terms of turnover, the twenty-fold increase in real terms from 1990-2008 (with exports starting in 1985 and peaking as a percentage of turnover in 1992 indicates) indicated a strengthening, with an average 30% of value add as a percentage of turnover.

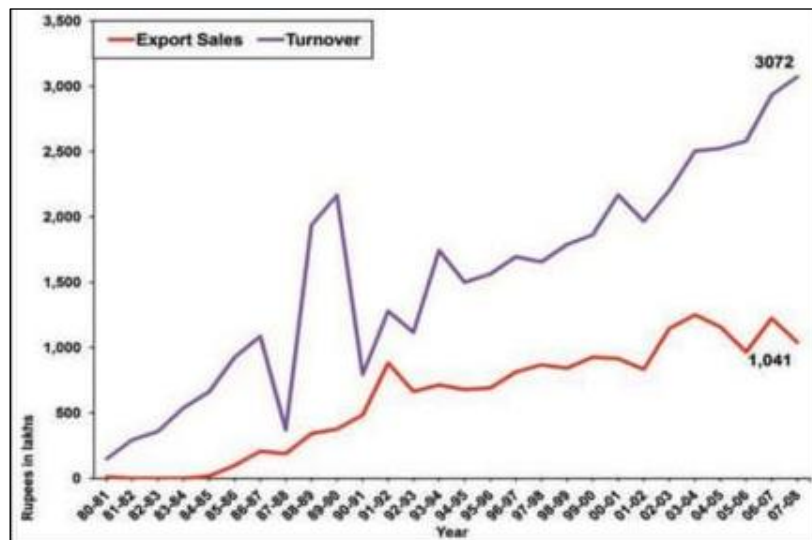

(Source: Thomas and Thomas, 2013, 197)

⁷⁸⁸ Complete data was not available with the BCC as of May 2023; however, it appears that trends observed from 2007-08 to 2014-15 have continued, and we proceed on that basis. Data collection in general appears to be weak, a point of some concern.

⁷⁸⁹ Thomas and Thomas’ calculations include contributions to the Central Fund as part of the value-add, rather viewing them as a tax. This drives the figures up accordingly.

⁷⁹⁰ Thomas and Thomas, 2013, 187. See, Ayer et. al., 2019, 6-7 for NVA projections.

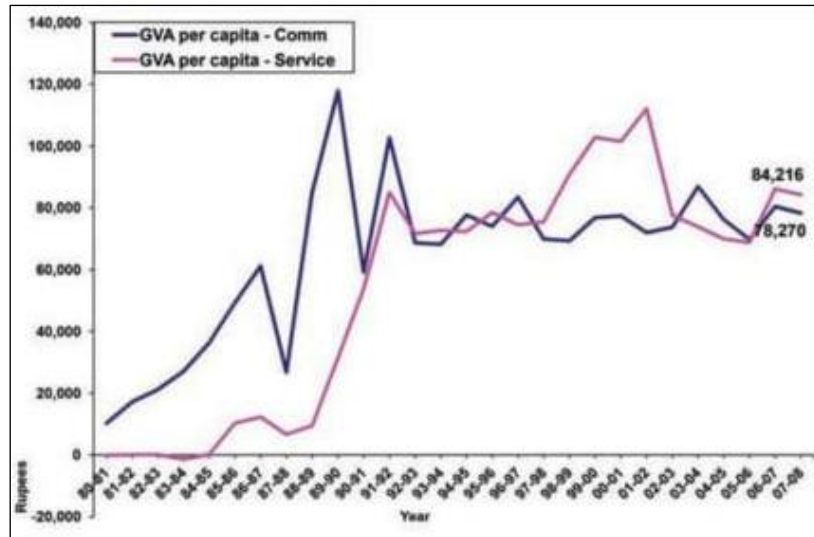

(Source: Thomas and Thomas, 2013, 202)

There is a declining trend post the 2000s, which poses concerns:

This downward direction holds a warning, as it indicates that more effort in terms of generating income is required to obtain the same resources or value for Auroville's internal economy. A deeper analysis show that the larger commercial units average 49-51% as against the 35% seen as the average of the total commercial sector. On the other hand, the percentage for ships and boutiques [given enhanced competition] drops down to 16%.⁷⁹¹

The increase in GVA in the 1980s, assisted by market-oriented production, leading enterprises, strategic exports and diversification, stagnated, and in some years, decreased, in the 1990s. A declining trend is again naturally observed post 2000, which has intensified since with competition eroding profit margins, again indicating productivity and sustainability concerns. Ayer. et. al. in 2019 similarly find that the 'ratio of surplus generated to net value added is low to moderate in almost all sectors' between 2008-2018.⁷⁹² As Thomas and Thomas note:

The figures presented here are of critical importance for Auroville's expansion in terms of population, level of income (maintenance) for Aurovilians, and the strength of the commercial and service units.⁷⁹³

There are structural concerns behind these trends, most importantly that of high labour-intensive activity, demonstrated in low capital intensity of production (measured as the ratio of capital to NVA, at 0.9) in the following graph.

⁷⁹¹ Thomas and Thomas, 2013, 199.

⁷⁹² Ayer et. al., 2019, 8.

⁷⁹³ Thomas and Thomas, 2013, 201.

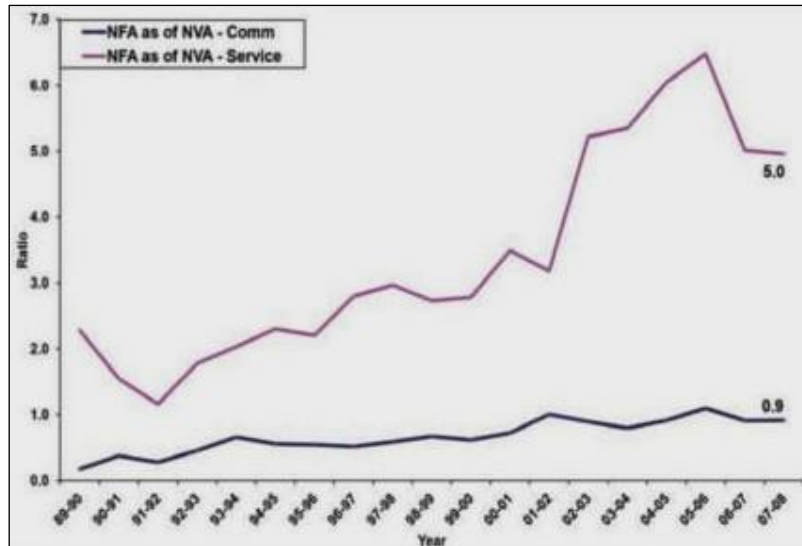

(Source: Thomas and Thomas, 2013, 197, 204)

As growth came in largely small units – with a three-fold increase in the number of units – Thomas and Thomas note that the capital strengthening of the 1980s faded in the 1990s onwards, with insufficient capital formation for reinvestment and growth of the commercial sector. As of 2007-2008 – with a marginal increase since – only ten units had a surplus of over 10 lakhs, averaging 19.2 lakhs per unit, or 15 lakhs without Maroma, and only 16 units between 5-10 lakhs, averaging 7 lakhs per unit. They note:

During the 1980s both expansion and capital strengthening of commercial units took place. However, from the early 1990s onward a different pattern is observed. Further expansion no longer resulted in a deepening of the capital structure of individual units; rather than expansion of the number of units happened, which left the capital-intensity in 2008 at exactly the same level as 15 years earlier.

...

Looking at the amount of capital per adult Aurovilian, we see a significant increase (around three times) from 1982 onwards till 1988 in the commercial sector. Initially, this resulted in both new units and capital-strengthening. From 1988 onwards, however, the total funds mainly increased due to the expansion of the number of units rather than increase in capital intensity.

...

For a full understanding of the previous findings, it should be realized that capital formation in the early years onwards was not directed towards building a strong commercial sector. On the contrary, the core of capital formation, particularly during the initial decades, fell on highly labour-intensive involvement in afforestation of heavily degraded land, fostering diversity of flora and fauna, building houses, clinics and schools, creating infrastructure, and the construction of the Matrimandir ... As a

result, an enormous ecological, social and spiritual ‘capital base’ has been established, the value of which cannot be captured in quantitative terms.⁷⁹⁴

The evolution of the commercial profile of the sector narrates a similar story, with concerns of diversification and resilience. The early pioneering work of Aurelec and related companies – consistent with Mother’s ideal of innovation-led production, to be at the cutting-edge of new developments – supported a strong electronics sector, which subsided after its sale. The handicrafts, clothing and textiles sectors, in a burgeoning of small, labour-intensive activity became dominant from the 1990s onwards. The small-scale profile is reflected in employment numbers – a 2021 survey of twenty units conducted by Manjula and Helen recorded the average number of Aurovilians and non-Aurovilians working in a unit at 5.3 and 15.5 respectively.⁷⁹⁵ This is consistent with the overarching cultural profile of developing natural products and services and serving the employment needs of the bio-region. As we consider below in Section (iv), a cultural – not just institutional – shift towards research-oriented tertiary sectors and medium to large scale manufacturing is necessary both for economic and ideological reasons. Alongside, other miscellaneous sectors, also small-scale – printing units, accounting services, cartoonists, photographers, taxi and travel agencies, architecture and construction units, landscaping services etc. – grew with developing expertise in sustainable building techniques and a growing tourism sector. However, as Thomas and Thomas note, food production and processing ‘has played a (far too) modest role in Auroville’s economy’, an under-leveraged asset and matter of concern today as we discuss in Part III.E.

The transitions of the commercial profile across these units indicates limited diversification – in 1982-83, textiles and handicrafts accounted for 30% of the turnover with electronics at 71% (and shops, food production and processing etc. occupying a minor role). This gradually shifted to 48% (with growth mostly in small units as we noted) and 13% respectively (with an increase in food production and processing to 8% and shops to 13%). As the aggregate total surplus, however, remained low with a declining trend, the resilience of Auroville’s economic setup today is concerning. Within this distribution, the Central Fund is overdependent on a few units – ‘19 units from 2007-09 had a turnover of more than 100 lakhs. These 19 units made up to 62% of the total turnover, had 60% of the total surplus, and contributed 60% of the total contributions.’⁷⁹⁶ Maroma, in particular, has played a dominant role accounting for 17-22% (in some years more than 50%) of the total contributions. In serving as a stable source of contributions, it has anchored the growth of the Central Fund.

However, this state of affairs raises concerns as to the resilience of Auroville’s economic setup. Thomas and Thomas sounded an important cautionary note in 2015:

What is worse is the small growth of these larger Auroville units. By any outside criteria, these units are still small enterprises ... The total surplus of the larger income-generating units has gone down. In 2007/8, 16 units had surpluses exceeding Rs. 10 lakhs; in 2014/15 only 9 units had. The total net surplus has fallen from 4% to 1%.

⁷⁹⁴ Thomas and Thomas, 2013, 187, 189.

⁷⁹⁵ Manjula and Helen, 2021, 10.

⁷⁹⁶ Thomas and Thomas, 2013, 217.

This is very worrisome ... For if this is not addressed, after a couple of years, you'll be looking at negatives.⁷⁹⁷

This concern was also voiced by the TDC at the Residents' Assembly General Meeting of 7th April 2015, with no movement on the Pony Farm and Mangalam clusters in the Industrial Zone in the previous year after the TDC's Annual Development Plan, 2014-15:

There is no queue of activities [for the Industrial Zone] for the moment, but the economy of Auroville has become an emergency (for example: 80% of Aurovilians cannot afford any of the existing residences). For the moment, the economy is turned towards tourism, but other essential Aurovilian products are necessary ... The economy needs to grow.⁷⁹⁸

Similarly, considering the period from 2008-2018, Ayer et. al. confirm the trend identified by Thomas and Thomas till 2015, with a modest average surplus of Rs. 2 lakhs per unit. They note:

Comparing the turnover, net value added, total surplus, employment and surplus to the NVA for commercial units [without Maroma], there are indications of stagnation.⁷⁹⁹

Commercial Units	Number of Units	Turnover	Turnover per unit	Surplus	Surplus per unit	NVA	NVA per unit	Nos. of maintenances	No. of maintenances per unit	NVA per maintenance (Labour project)	Surplus per maintenance	Surplus per NVA	Value added assets (capital product)
Lakhs (average values, 2008-2018)								Aurovilians		Lakhs		Ratios	
All domains (commercial and services)	365	5994	17	747	2.04	2149	6.06	577	1.68	3.82	1.34	0.34	0.30
Total Commercial Domain	265	3909	16	343	1.30	1271	5.02	371	1.49	3.44	0.93	0.27	1.13
Architecture and Construction	35	531	15	67	1.90	171	4.86	60	1.84	2.82	1.12	0.39	2.25
Electronics, Engineering and Consultancies	35	531	15	67	1.90	171	4.86	60	1.84	2.82	1.12	0.39	2.25
Eateries	14	217	16	33	2.43	77	5.36	21	1.74	3.48	1.48	0.42	1.68
Guest Houses	18	146	8	28	1.55	63	3.40	14	.85	3.58	2.81	0.40	0.47
Handicrafts	48	894	20	83	1.73	317	6.88	63	1.39	5.06	1.33	0.26	1.35
Handicrafts minus Maroma	47	348	8	28	0.60	135	2.93	57	1.27	2.39	0.51	0.21	1.47

(Turnover, NVA, Surplus for commercial and service units, 2008-2018. *Source*: Ayer et. al., 2019, 7)

⁷⁹⁷ Auroville Today, January, 2015, 37; Auroville Today, April, 2016, 7.

⁷⁹⁸ TDC, Annual Development Plan, 2014-15, 18.

⁷⁹⁹ Ayer et. al., 2019, 7.

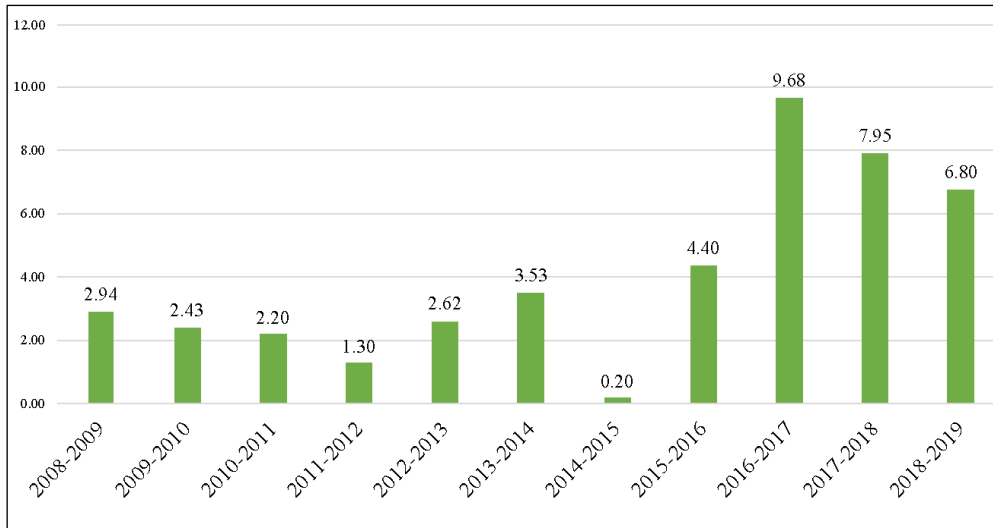

(Total surplus across commercial trusts / units, 2008-19, in crores. Source: Auroville Foundation Annual Reports, 2008-19)

The number of units between 2008-9 and 2018-19 grew by 38%, from 129 to 179, with a 31% increase in surplus (with a sharp fall in 2014-15 and spike in 2016-17).⁸⁰⁰ Within these, handicrafts and architecture and construction account for a majority of units, with the NVA per unit on average from 2008-2018 for handicrafts (minus Maroma) significantly lower than other sectors, 42% compared to the average of other commercial and service units. The limited avenues for capital formation and growth with the predominantly small units, indeed their viability given increasing competition in the handicrafts, textiles, eco-products etc., is a cause for concern. As of 2019, the majority share (46%) of surplus generation lies with three trusts, with Aravinda Trust (with one unit, Maroma) contrasted with ABC (29 units as of 2018-9), Aletcs (4 units) and by comparison, Artisana (27 units as of 2018-19).

⁸⁰⁰ These are approximate figures as reporting standards changed in the Annual Reports during this period, leading to uncertainty. The reason for the sharp fall and spike is unclear.

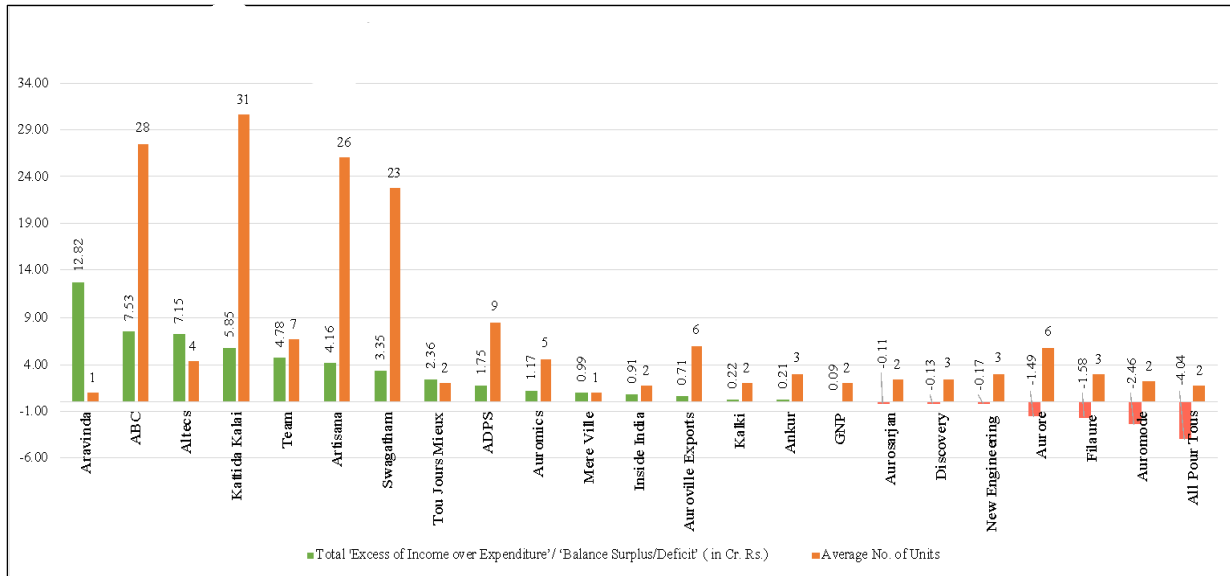

(Units per trust-wise contributions, 2008-19. *Source:* Auroville Foundation Annual Reports / Budget Coordination Committee data)

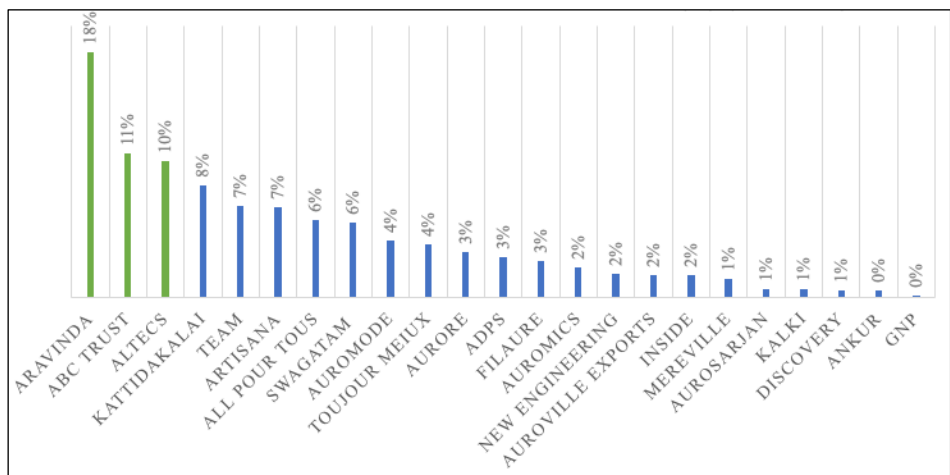

(Trust-wise percentage contributions, 2008-19. *Source:* Auroville Foundation Annual Reports / Budget Coordination Committee data)

One major impediment to capital strengthening – developing medium-large scale enterprises or tertiary-sector activity – is insufficient lines of credit. Either for legal reasons, pertaining to borrowing constraints under the AVF Act discussed below, or otherwise, risk aversion being primary. Auroville’s commercial sector has largely been driven by individual funds, without access to banking channels, thus significantly limiting the scale and size of the units. Thomas and Thomas note that the loan amounts – which are funds invested by individual residents starting those units, rather than external credit – were significant relative to income generated, yet were of ‘critical importance to cross a threshold of gaining some operational structure’.⁸⁰¹ This speaks to the commitment of each resident to the activity, yet presents structural concerns.

⁸⁰¹ Thomas and Thomas, 2013, 185.

As of 2007-08, borrowed funds represented only 10% of the total credit, at a modest sum of Rs. 2.73 crores. Thomas and Thomas note:

Throughout these past 40 years, securing loan funding through access to credit lines has played a very modest role. The most and rather constant level of loan funds – even less than 15% from 2002 onwards – indicates the limited access to or low preference of commercial units for credit lines.

This naturally poses problems for the growth of the commercial sector to serve Auroville’s city-building works, or indeed to ensure survival amidst enhanced competition, automation and productivity increases elsewhere, to diversify outside developed and limited niches in labour-intensive cottage industry, handicrafts, textiles etc.

One conscious strategy to dent this structural concern has been a concerted effort to build the services sector, through (i) grants and donations tied to infrastructure projects, (ii) leveraging income-generation in the research-intensive services sector and (iii) interest on deposits kept with the Financial Services. The relative share of income from services (grants / donations and other services) and commercial sectors has shifted significantly over the years.⁸⁰²

Year	Grants and Donations (in lakhs)	Other Services (in lakhs)	Commercial (in lakhs)
1992-93	625 (30%)	158 (8%)	1277 (62%)
1997-98	810 (26%)	460 (15%)	1797 (69%)
2002-3	1140 (27%)	653 (15%)	2245 (58%)
2007-8	1086 (19%)	1210 (21%)	3491 (60%)
2020-21	6482 (54%)	~2963* (24%)	~2673* (22%)

The approximately five-fold increase of external donations and grants (Government of India plan and non-plan grants, institutional and private donations from India or elsewhere, under the SSR and SR heads) is significant, and has allowed for strong investment in infrastructure building and indeed, recurring expenditure of various sectors, particularly education (40% of the Rs. 38 crores received from Government of India grants, for example, going towards recurring costs).

⁸⁰² * approximate, given variation in accounting.

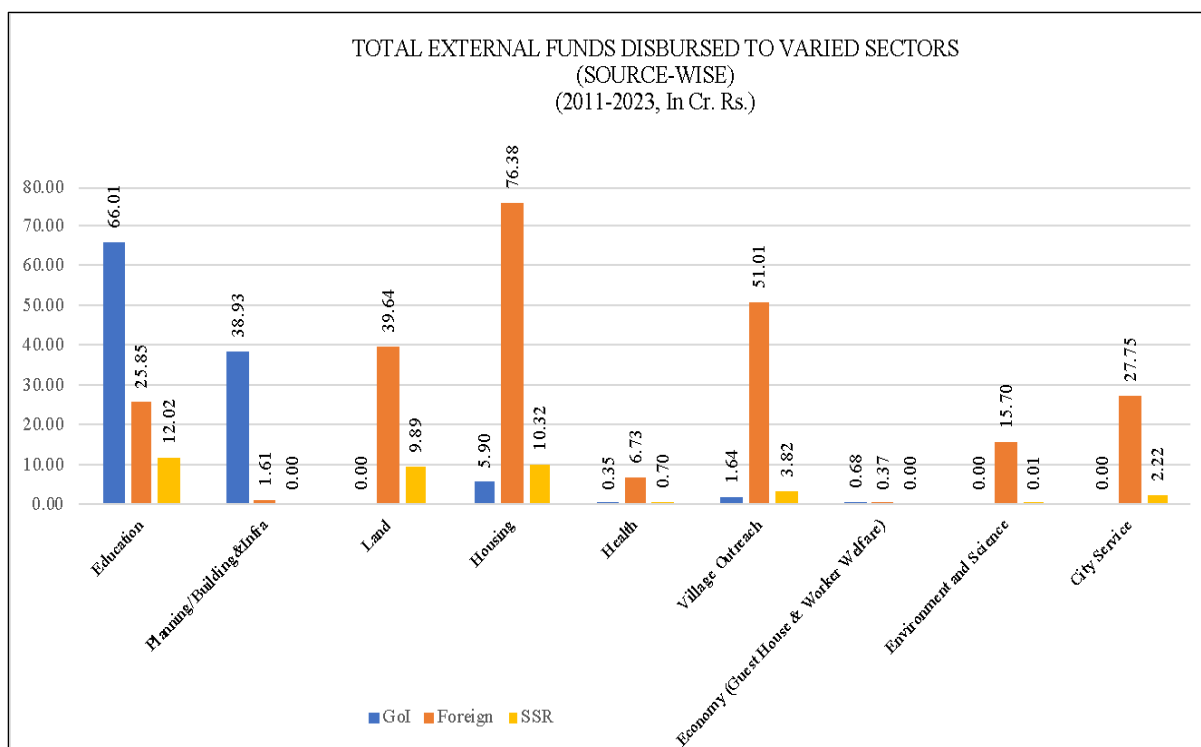

(Sector-wise external funding, 2011-23. *Source:* Unity Fund)

Between 2011-2023, the three key sectors that received the majority financing have been education (Rs. 103 crores), housing (Rs.93 crores) and village outreach (Rs. 56 crores). Other key areas of funding have been land acquisition/management (Rs. 50 crores) and planning/infrastructure development (Rs. 40 crores). Foreign donations have largely supported housing, village outreach and land acquisition activities; while Government of India grants have been channeled towards education and planning.

Tellingly, between 2011-2022, recurring expenses in major sectors (barring housing) have been more than non-recurring expenses. Unsurprisingly, given governance concerns outlined in Part III.A, despite the on-paper emphasis on city-building, it has seen the lowest spending of funds, both recurring and non-recurring expenses, including the construction of roads, cycle tracks and transportation development.

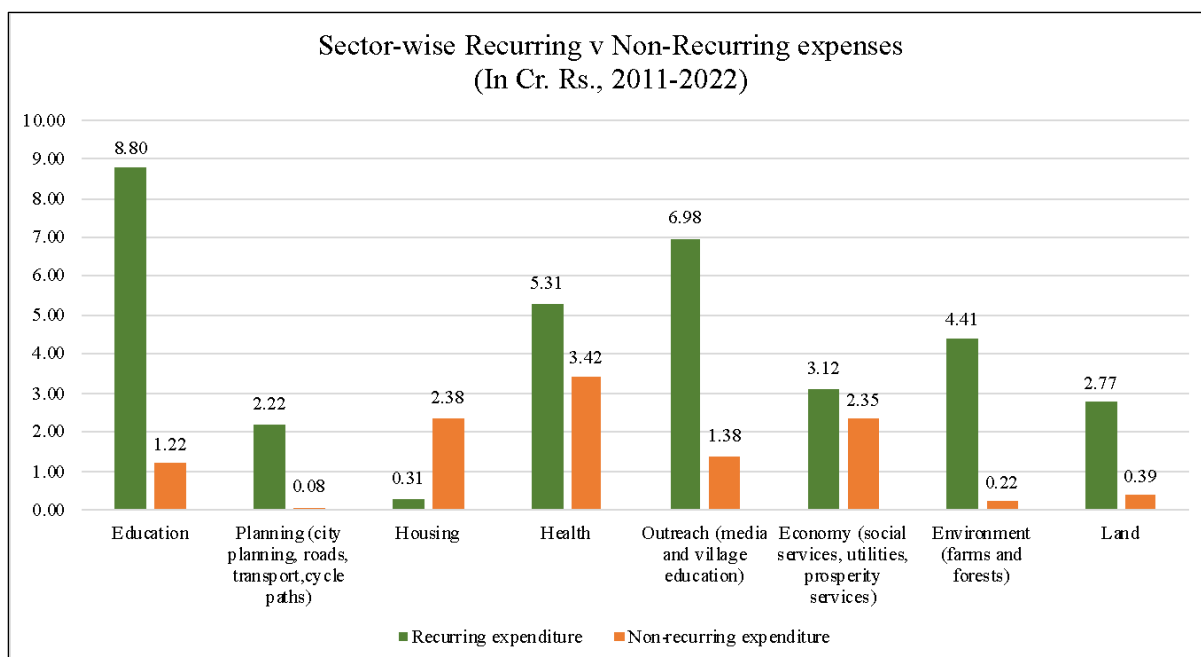

(Recurring versus non-recurring expenditure for external funding, yearly average, 2011-22.
Source: Unity Fund)

It bears noting that developing reserves in this context is unlikely as grants and donations received for these sectors are earmarked for time-bound spending on identified projects. In consultancy work, either in education, ecology, agriculture or building / planning, there is a promising potential for revenue and surplus generation, leveraging the capital base of expertise developed over the past four decades in Auroville.⁸⁰³ This has already begun, particularly in sustainable building and ecology, though the formal educational sector has (perhaps understandably) not yet taken to this option. As we indicate below, developing integrated consultancy and educational (vocational and otherwise) services is an area in which short-term action can yield fruit.

Thomas and Thomas recorded this shift to the services sector, as of 2008, intensified since, with the note that developing the ‘city’ will be dependent at least in the short term on grants and donations, which will require a strategic and cohesive fundraising effort, currently not in place:

Till the late 1980s capital in the commercial domain far exceeded that of the service units. However, this balance shifted completely thereafter. Already by 1997-1998, and even more so by 2007-2008, the situation had changed significantly: in 1997-1998 total funds per capita in the services domain had become almost twice the aggregate of commercial units, and in 2007-2008 around 2.5 times, in fact Rs. 4,24,088 as against Rs. 1,70,801. The weight of the services on Auroville’s economy had apparently shifted in a major way as far as its capital structure is concerned.

While for the commercial domain turnover within India may continue to expand, and exports may become a more stable segment of income, Auroville will need for many years a steady inflow of grants and donations as the main source for developing its

⁸⁰³ Thomas and Thomas, 2013, 250, 251.

urban infrastructure. Though service revenues, other than grants and donations are on an upward trend [as of 2020-21 at par or slightly more than the commercial sector, as above] and show that Auroville is slowly reducing its reliance on grants and donations, [this finding as of 2007-08 does not hold true as of 2021-21, as grants and donations accounted for 54%] it will take a long time before it can be fully self-reliant while building a city for a project population of 50,000 people.⁸⁰⁴

Given this emerging picture, with a small-scale, labour-intensive commercial profile, strong and rising gains in the services sector, and substantial dependence on grants and donations, Thomas and Thomas offer the following concluding observations, made in 2008, and repeated in 2015, equally relevant today:

While Aurovilians from all corners of the world are united in a deep commitment to shape a new, coherent social and economic policy, one observes two rather different economic domains: a commercial sector consistent of units ruled by the mechanism of market economies, and a service sector that aims at shaping a no-money-circulation economy within Auroville itself ... Auroville's commercial domain has experienced patterns that are characteristic for the usual development that has taken place over past centuries in all parts of the world; one may say 'no surprises'.

With very limited access to investment re-sources, one finds an over-representation of labour-intensive production units in handicrafts and textiles and, for incidental reasons, special cases of involvement in electronics and computerisation. Apparently, the development of Auroville's commercial domain has been left to individual initiatives, which at no point in time were guided by a collective institution for overall planning and coordination. Hardly any evidence could be found of conferences, workshops or studies to address complex phenomena such as changes in labour markets and skills, long-term productivity, requirements for investment capital, to mention just a few issues [with the exception of Hemsell's early proposal]

In more recent years, a greater diversification is seen, with promising involvement of knowledge-intensive activities that are closely related to specific skills and experiences of Aurovilians in the field of ecology. Yet, this development is also conditioned by the initiative of some people rather than embedded in a long-term strategy for positioning certain Auroville growth points within the Indian economy.⁸⁰⁵

Finally, in terms of the health of the Central Fund – the issue of contributions and maintenances – the total income received in 2007-08 was Rs. 314 lakhs, with Rs. 286 lakhs expenditure and a small reserve of Rs. 88 lakhs; in 2020-21, Rs. 2170 lakhs (including services sector and unspecific donations, but excluding other grants), with Rs. 1882 lakhs expenditure. This is substantial increase, in large part to the growing non-donation services sector, with 72% disbursed to four sectors: education, social support, municipal and prosperity services and health.⁸⁰⁶ As of 2022-23, the Central Fund supported 1565 maintenances (approximately 50% residents, a fairly high number, indicating a strong distributive ethic though at modest income-

⁸⁰⁴ Thomas and Thomas, 2013, 241.

⁸⁰⁵ Thomas and Thomas, 2013, 254-5.

⁸⁰⁶ The impact of COVID-19 appears to be minimal, as amounts in 2019-20 and 2022-23 are in this range. This requires verification.

levels), accounting for 64% of the expenditure. This is in contrast to 0.8% on new assets, 3% on immovable asset repair and 26% on non-maintenance, recurring expenditure. Infrastructure or asset development, particularly housing, is thus a marginal proportion of the City Services Budget (relying almost exclusively on donations / grants or individual investments in housing etc.), with by and large welfare spending on the social sector, as part of the prosperity ideal. With stagnating growth, limited surplus (which may only be further affected by enhanced competition in handicrafts, textiles in India) and a fairly high contribution rate (33%) already in place, it is unclear how this spending can be maintained absent productivity increases. The demographic concern identified in Ayer et. al. with an ageing population is a matter of additional concern here, as one would expect decreases in per capita productivity and a 'pension-maintenance' in the future, which may further place pressure on the fund.⁸⁰⁷

In other words, the 'carrying capacity' of the Central Fund, in Thomas and Thomas' articulation the number of maintenances that it can support, is under pressure – to sustain the distributive ethic, a core tenet of the 'prosperity' ideal, with higher maintenances / free or subsidized collective provisioning of basic necessities. Structural concerns with the commercial sector – productivity, capital intensity, credit, contributions leaving insufficient capital for reinvestment, depreciation and financial shocks – and a strategic growth of the services sector require urgent attention.

These concerns, we may note, have been voiced repeatedly since 2006, but without any discernible policy action, particularly an economic growth plan or a development plan for the Industrial Zone. For example, in 2006, Revi noted:

Auroville's current economy appears to be rather rudimentary as inferred from the available guestimates of economic throughput, surplus creation and capital formation. Auroville's primary economic achievements have been the regeneration of the core area of the city through a remarkable process of greening over the last forty years; the survival and growth of multiple pioneer communities; a series of intense experiments with various urban subsystems including water and renewable energy. A number of small enterprises have been created which reportedly provide a moderate level of employment to people from the surrounding villages. Nevertheless, Auroville in 2007 appears to be far from being a sustainable economic entity that will be able to hold its own in a highly competitive world that would then be necessary to enable the flow of resources that will be required to build the 'city'. No amount of metaphysical arguments about intangible value added can substitute for this basic material viability.

⁸⁰⁷ A 'Senior Aurovilian Survey' was conducted in 2011-2012. *See*, Auroville Foundation Annual Report, 2011-12, 24. We were unable to locate this document. Projections for future senior-case support are necessary given current demographic trends. The issue of support for the ageing population is a key, and an under-appreciated, concern for Auroville's economic planning. *See*, for example, Auroville Today, January 2021, 21 ('If some older Aurovilians who worked for commercial units may expect to receive a pension-maintenance from that unit – assuming the unit continues being in business – those who have been working for Auroville's services do not receive that benefit. Some may have savings or will receive a private or state pension. But an increasing number of Aurovilians do not have those advantages. A subgroup constituted by the Funds and Assets Management Committee has been working on the modalities of a so-called Silver Fund, which is yet to be presented to the community. Stephan, one of the group's members, explains that the idea behind the fund is to guarantee a basic maintenance for any Aurovilian who has lived in and contributed to Auroville for a long period of time, say 25 or 30 years.')

These intangibles are necessary and will add tremendous value to fundamental economic and financial viability, once established. The lack of basic self-sufficiency around food and energy, and therefore the need to trade products and services only highlights this imperative.

A few moderately successful enterprises have been established in the crafts and small-scale sector in Auroville, even though a bulk of the enterprises are reported financially 'sick'. No major engineering or manufacturing enterprise is currently based in Auroville – partially because of a concern about protecting the environment ... The economy of Auroville is currently under capitalized, has a sub-critical base of workers (in spite of a large fraction of active working population) and an underleveraged human resource base. This is a matter of concern as the 'city' will need to function in a balanced manner in the material, vital and mental planes for it to achieve its long-term mission. Achieving this balance will be a serious challenge to structure of livelihoods and the need for enhanced human, capital and resource productivity to free-up the necessary time for the pursuit of inner development by Aurovilians. This is not possible without the creation of surplus value in the material and financial worlds.⁸⁰⁸

Similarly, in 2016, Thomas and Thomas registered a timely concern over lack of progress since their 2008 study. Oddly, despite a general awareness in the community of their work, no follow-up work either from the FAMC or ABC are available in the records, either in terms of action plans to address their concerns or alternative views / criticisms that chart out a different pathway / support the existing trajectory.⁸⁰⁹ A thriving research culture in economic and social policy would ideally result in such material, engaging with the first global study on Auroville's economy. Given that theirs is the only comprehensive study to date, we quote their comments made in 2016 at length. They continue to remain relevant and pressing:

There has been a substantial growth of very small units, from 52 in 2007/8 to 108 today. But they questioned if this shows a vibrant start-up culture or if it is rather indicative of a survival strategy. These units all have a turnover below 5 lakhs, which means a turnover of less than Rs 42,000/month. This means they are making a minimal contribution to Auroville. What they see missing is the willingness of the smaller units to scale-up. The working groups that are involved with assets and business do not appear to have studied the matter and have given the required support and mentoring. This, they believe, should change. They recommend that Auroville focus on a few promising units and cluster and support them, so that their growth and contribution to Auroville can become meaningful. The others can continue in the way they like. Auroville's service units have also shown little development. 15 years ago they had a total revenue of 22 crores; now it is 25 crores, a marginal increase. The situation for grants and donations is similar: 15 years ago, grants and donations were totalling 21% of total monies received. There is hardly any change today.

The results of the first 40 years showed us that the Auroville economy was struggling; today it can only be said that the economy is struggling even more. In fact, Auroville's economy is in dire straits. In terms of actual rupees, the total turnover of all the

⁸⁰⁸ Revi, 2007, 7-8.

⁸⁰⁹ Danino, 2021 records concern with the view of Thomas and Thomas. Insofar as the concern relates to a conscious, environmentally sustainable productive sector, these are in line with Thomas and Thomas.

income-generating units, which are the backbone of Auroville's economy, has been rising nicely, as has their total surplus (the surplus after expenses and depreciation but before contributions to Auroville). But this is an illusion, as the rupee has lost value from year to year. A correction for inflation has to be taken into account, and then the picture becomes very different. With the year 2000/1 as base, we see only a modest rising of turnover and a decline of the total surplus and of the net surplus.

What's the cause? 'We've heard that it was due to the recession of the world economy. But we've found that this statement doesn't hold. Since the year 2000, Auroville units have increasingly started doing business within India, and their exports have declined. Auroville's economic development, then, has to be compared to that of India. The Indian economy has become the fastest growing economy in the world, with an average increase of 7% a year, in inflation-corrected terms, and it should have had a major stimulating effect on Auroville. But this has not happened. This means that we have to look for the causes within Auroville itself. We conclude that Auroville has not sufficiently reoriented itself and come up with solutions for reinventing its commercial approach in these dramatically changing times.'

When we looked at the performance of the larger income-generating units, we saw a negative development which has increased from 2007-8 onwards,' says Manuel. 'After 2007, there has been a reduction of the number of larger income-generating units, as well as of the total value generated by them.'

In 2007/2008, 13 units had a turnover of more than 100 lakhs. They represented 51% of the total turnover. Over the years, that number has gone down to 10 units, who are responsible for 43% of the turnover. The decline in the number of larger units is worrying. Some large units, such as Filaure, have stopped functioning altogether. No new units have come forward to take their place. Maroma, which has played a leading role for decades, is still the dominant unit. The normal scenario is that a unit grows, plays a lead role for some time, and then others take over. But this hasn't happened. Moreover, the units that are doing well are led by older Aurovilians. Succession planning seems to be near to non-existent [also the finding Manjula and Helen, 2021]. In any outside company, two well-trained successors are the norm, but where is that development in Auroville? These are not healthy developments.⁸¹⁰

Various other development cross studies have pointed to this fault-line. As we discussed above, the TDC's Annual Development Plan, 2014-15 – defining development works and population increase targets for 2014-19 – examined the economic viability of a 117% rate increase in population growth (from the existing 2,300 residents to 5,000 residents) by making income projections from current trends. Assuming that Government grants remained stable. It noted that cyclic stagnation in the sector made this strategy unfeasible – the increase will not yield sufficient income in the short-term to cover the rise in Central Fund expenses (a limited 'carrying capacity' in Thomas and Thomas' sense), without further contributions (a 100% increase) from the commercial sector (unlikely for the reasons above). Accordingly, it notes:

⁸¹⁰ Auroville Today, April, 2016, 7 (inline comments ours).

A large expansion in Auroville population, will create a huge deficit in budgets unless the commercial units are helped to dramatically increase their income and contributions.’⁸¹¹

While new residents will in time generate greater income, to cover their housing and other expenses, with surplus to contribute to the Fund, the time lag between entering and reaching self-sufficiency / reasonable surplus generation leads to short-term shortfalls. To address these concerns, the TDC’s Annual Development Plan, 2014-15 suggested *prior* and *planned* investments in infrastructure (housing, entrepreneurship support and incubation) to counter the vicious cycle of economy-housing-population growth: ‘this would need a large and focused effort in assisting units, existing and new, on all levels also financially’ ... to start the revitalization of the industrial zone as one of the priorities in this context.’⁸¹² In particular, it proposed four projects: the densification of Auroshilpam, development of a small scale industrial park with a training campus in Mangalam, plotting of an integrated economic zone with housing and low cost transitional units in Pony Farm and a collective living area integrated with educational and economic activities for 750 people. Yet, no strategic plan to this end was prepared, or implementation undertaken, owing to ‘development blockages’, particularly (i) achieving community consensus,⁸¹³ (ii) lack of investment and proposals for starting new business initiatives in Auroville (a singularly worrying fact, as it concerns initiative, rather than practical concerns), and (iii) lack of funds for investing in infrastructure especially water connection and electricity.

Similarly, in 2013, the ISP suggested an increase in capital flows and ‘clear economic guidelines to encourage income generating activities in line with Auroville’s ideals and reviving the role of the Auroville Board of Commerce’. Next, in 2014, the IDPP suggested investment of capital and infrastructure in ‘scaling-up enterprises relate to AV’s core strengths’ and ‘identification and promotion of catalytic sectors’ with a small business centre, networking program to link Auroville entrepreneurs with public and private sector entities and academic institutions and business plans for units in key service sectors in line with Auroville’s ideals and emerging expertise, renewables manufacturing, data management, health and medical technology etc. A year later, interestingly, three out of four ‘milestones’ identified at the 2015 Retreat related to distributional issues (developing an in-kind, caring economy, expanding ‘prosperity’), with the creation of ‘new initiatives for wealth generation, including an incubation centre’ / ‘innovation support laboratory’ identified as a priority, though without any specifics indicated, by April 2016. Alongside, various independent, resident-led initiatives emerged in response to these concerns – the Lotus Group, Integral Entrepreneurship Lab, New Economy Lab, the ‘Re-visioning FAMC’ presentation by Chandresh, an entrepreneur who ran Saracon, an Auroville incubator for knowledge-economy driven growth.⁸¹⁴ Four years later, Ayer et. al. noted capital formation concerns:

⁸¹¹ TDC Annual Development Plan, 2014-15, 8 (emphasis in original).

⁸¹² TDC Annual Development Plan, 2014-15, 8.

⁸¹³ See, Part III.A for the Residents’ Assembly General Meeting on this issue.

⁸¹⁴ See, Thomas and Thomas, 2013, 170-172.

50% of units are small enterprises, unable to build up capital investment, diversification and growth, thus become non-viable at the worst or stagnate as one- or two-person self-employment enterprises.’⁸¹⁵ [Given stagnant and low NVA from 2008-18, they confirm the Town Development Council’s Annual Development Plan, 2014-15] ... it is clear that it may not be possible to generating sufficient employment to absorb a population growth rate of more than 3-4% ...’⁸¹⁶

However, these periodic interventions, with Thomas and Thomas’ important work, have not translated into policy-action to address the rather alarming structural concerns identified across the board. This indicates chronic governance problems, which we address below. The records indicate that despite these learnings, the ‘policy dialogue’ (though there is no coherent ‘policy’ framework / institutional setting, as we discuss below) has traditionally focussed on distributional issues, namely the ‘no-money-exchange’ and ‘prosperity’ ideals. It appears this prioritisation has been at the expense of valid growth and productivity concerns.⁸¹⁷

In sum, Auroville’s economic setup requires urgent action to address its small-scale, under-capitalized, labour-intensive commercial profile. The concern is not in relation to individual units, but structural. The growth of the sector, particularly from its humble origins and despite resource constraints, is a significant achievement, a labour of love of many.⁸¹⁸ Progress has also been registered in substantial, though variable, increases in grants and donations and a strengthened ‘services’ sector since the 2000s. Yet the future ‘city’ demands expansion, diversification and structural changes whether to meet its ideal of economic self-sustenance, serve the imperative of city-building, lead entrepreneurial activity, anchor the ‘prosperity’ ideal or indeed sustain moderate income / ‘maintenance’ levels. We suggest action along four axes: (i) strategic and time-bound development of the Industrial Zone, (ii) institutional / governance re-structure, (iii) shift in mindsets / orientation towards commercial activity and (iv) strategic planning to attract and retain talent and capital in line with Auroville’s ideals. We address these briefly below.

As a quick exercise in historical benchmarking, it is interesting to note that action along these lines was anticipated in Mother’s 1965 Ford Foundation letter and later, in the 1969 document on the ‘First Approach to the Town’. The latter anticipated that 15% of the population will be engaged in ‘industry’ compared to 10% in ‘cottage industry’ and 45% in ‘services. It envisaged that ‘industrial activities of the classical type [currently absent in Auroville, will be] localized in the lower part of the periphery of the [Industrial] zone’, with a ‘high degree of automation’, a major adoption gap in Auroville today. Alongside, the ‘vertical economic zone’ buildings (which appear, though not clear, to be the Lines of Force, which can naturally accommodate

⁸¹⁵ Ayer et. al., 2019, 5.

⁸¹⁶ Ayer et. al., 2019, 6.

⁸¹⁷ Thomas and Thomas, 2013, 103.

⁸¹⁸ See, Henke Thomas’ remarks quoted in Majumdar, 2017, 258 on leading efforts in Auroville’s commercial sector insofar as social enterprise goes. Manjula and Helen, 2021 address this in more detail with a survey of units with an environmental or social policy objective. Various enterprises, Maroma, Upasana, Shradhanjali, to mention a few, have produced a bouquet of beautiful products for which Auroville is now well-known. Thomas and Thomas, 2013, 136-181 for case studies of some enterprises of note. The Annual Report of the Auroville Foundation for 2004-5, 49 notes: ‘Auroville reflect high standards of quality since the units of Auroville endeavour to reach material perfection.’

offices for professional and tertiary work, not industry) were to accommodate ‘two types of tertiary activity’ (‘economic block’ and ‘collect[ive] service’) with the following distribution:

— Vertical Economic Zone:

(0)	(1)	(2)	(3)	(4)
1	22.000m ²	8	0.65	114.000
2	18 000m ²	7	0.65	81 900
3	8.000m ²	6	0.65	31 200
4	18 000m ²	6	0.65	70.200
5	15.000m ²	5	0.65	48.750
6	15 000m ²	4	0.65	39.000

(0) = No of building
(1) = Surface covered on the ground
(2) = Average number of levels
(3) = Coefficient of utilisation
(4) = Useful surface.

(Plan for the ‘Vertical economic zone’ / Line of Force. *Source:* Anger, ‘First Approach to the Town’, 1969, 7)

Details apart, as the economic profile, population distribution and building plans today may vary based on developing conditions, what stands out is: (i) the emphasis on industry and tertiary activity as accounting for 60% of the working population, as opposed to 10% in cottage industry, (ii) the level of detail in planning in the early years, in stark contrast to the *ad hoc* approach till date, and (iii) the spatial emphasis on keeping industrial activity on the peripheries, whilst accommodating tertiary activity in the ‘vertical’ zone / Line of Force. The need for a diversification of the commercial profile and for strategic planning in catalytic sectors thus both find support in this early document.

b. Impediments to Growth

An insightful survey of commercial units conducted by Manjula and Helen in April 2021, ‘Exploring Auroville’s Capacity to Flourish’, speaks further to the challenges that lie in the sector.⁸¹⁹ They align with Thomas and Thomas’s 2008 work, Ayer et. al.’s 2019 study and our analysis above and limited interviews in the sector. The report evaluates 53 Auroville units in relation to their existing capacity, interest and challenges in scaling up operations. While the focus is on Auroville units which have a clearly stated social and environmental goals, the barriers faced in scaling up may hold true for Auroville units in general, irrespective of purpose. 70% of the units expressed a clear preference to scale up, for those in the start-up phase or expansion.

⁸¹⁹ Manjula and Helen, 2021.

	Number	%
Increase reach/ impact (new markets etc)	22	50
New projects	21	47.7
Increase production	12	27.3
New partnerships	10	22.7
Train others to deliver	8	18.2
Franchise model	3	6.8

	Number	%
Start-up/ growth	6	13.6
Growth	6	13.6
Growth/ mature	1	2.3
Mature	5	11.4
Mature/ expansion	16	36.4
Mature/ decline (or renewal)	6	13.6
Renewal/ growth	2	4.5
Mix of stages	1	2.3
Dormant	1	2.3

(Left, 'in which ways are you interested to scale'. Right, growth stage. Source: Manjula and Helen, 2021, 24, 4)

A majority of unit executives noted that they had only some or none of the skills required to start and grow units, with most learning on the job and a minority having undertaken professional training

	Yes	Some	No
Undertaken professional/ technical training	10 (22.7%)	1 (2.7%)	33 (75%)
Undertaken business training	1 (2.7%)	5 (11.4%)	38 (86.4%)
Undertaken personal development training	8 (18.2%)	1 (2.3%)	35 (79.5%)
Learning by doing	36 (81.8%)	8 (18.2%)	0

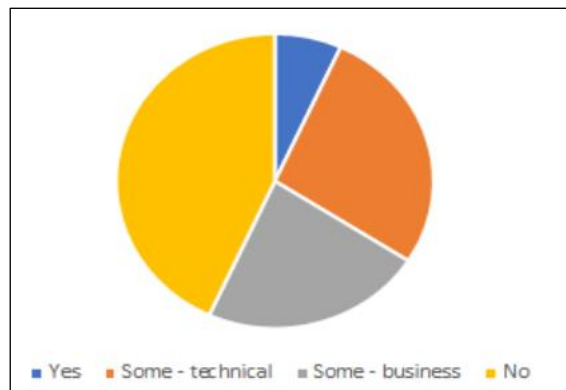

(Top, 'how you acquired the additional skills needed to run your unit'. Bottom, 'did you already have the skills needed to grow and run your unit'. Source: Manjula and Helen, 2021, 12, 13)

In term of succession planning or training the next generation, a majority of units (51%) were worryingly *not* inclined to do so. For 91% of the units, the founders were still the executives. In terms of challenges to growth, the skills identified by units as necessary for growth and regulatory challenges to overcome are instructive for future policy and planning:

	Number	%
Management/ HR	12	27.3
Marketing	11	25
Social media/ website	11	25
Technical (other)	11	25
Fundraising/ grant writing	9	20.5
Finance/ accounts	8	18.2
Admin/ documentation	7	15.9
Business development	4	9.1
Legal advice	3	6.8

(‘Where do you need help?’. *Source: Manjula and Helen, 2021, 16)*

Manjula and Helen also queried the challenges to effective collaboration between Auroville units and externally. Most respondents, 67%, wanted greater sharing between units and 68% wanted to expand externally.

	Number	%
Ego/ individualism/ personal issues	17	38.6
Time/ energy needed	9	20.5
Not understanding what they/others do	6	13.6
Different values/ standards	5	11.4
Lack of trust	5	11.4
Threat of product duplication	4	9.1
AV structures & bureaucracy	2	4.5

	Number	%
Lack of clarity on AV status (ie different PAN/ GST/ bank account)	11	25
AV bureaucracy	6	13.6
Inability to take investment	5	11.4
Import/ export issues	3	6.8
Reporting requirements of partner organisations	2	4.5

(*Left*, challenges to internal collaboration. *Right*, challenges to external collaboration. *Source: Manjula and Helen, 2021, 17, 19)*

	Number	%
Financial - lack of funds (generally)	19	43.2
People - lack of skills in team	15	34.1
People – hard to find/ retain Aurovilians to work full-time	14	31.8
Structural - AV bureaucracy	13	29.5
Finance - hard to get investment to enable growth	10	22.7
Structural - lack of support for units	10	22.7
Motivation - lack of personal energy/ interest	10	22.7
People - lack of people/time (generally)	8	18.2
People - hard to attract/ retain skilled workers (non-AV)	6	13.6
Structural - lack of workspace/ land	6	13.6
Cultural - fear (AV too risk averse)	5	11.4
Covid	5	11.4
Finance - hard to get right partners/ investors	3	6.8
Structural - AV systems not supportive of social enterprise model	3	6.8
Structural - AV not recognised as Higher Education provider	3	6.8

(*Left*, challenges to internal collaboration. *Right*, challenges to external collaboration. *Bottom*, barriers to scaling up. *Source*: Manjula and Helen, 2021, 26)

To the best of our understanding, this study has not yet translated into governance or institutional reforms. As such, five categories of issues emerge from this important work insofar as growth of existing units is concerned, independent of the need for diversification of the commercial profile to support growth in emergent, catalytic sectors: first, need for a governance structure to ease the compliance burden and increase operational freedom to scale; second, enabling credit; third, activating clustering dynamics, through greater collaboration and knowledge sharing, particularly in high-skill sectors; fourth, training and capacity building across the board, for managerial, technical, legal support amongst residents and non-resident employees, and succession planning; fifth, strategies to attract talent and capital through a liberalization of the regulatory infrastructure. We address these below.

c. MSME and Large-Scale Manufacturing

Auroville’s current economic profile currently has largely micro to small-scale enterprises, with labour-intensive production that limits capital formation and adequate surplus generation owing in large measure to limited productivity.⁸²⁰ While calls have been made to shut down such small enterprises, this is inadvisable as they respond to sustenance needs of the residents running those units are a source of employment and are a valid and important expression of their creative labour. However, an expansion into MSME and large-scale manufacturing is necessary, indeed as contemplated by Mother (with proposals for a ‘large ceramics industry’,⁸²¹ the comment that ‘the idea of Aurofood is good, and they are trying to make propaganda among

⁸²⁰ See, in general, for the importance of capital formation, Bal et. al., 2016. Auroville’s economic model does not exempt it from the need for capital formation.

⁸²¹ Guigan, 2018, Vol. 1, 56.

industrialists’,⁸²² proposal for the ‘sea-side where the big factories, godowns, stores and sheds, will be built to export goods’,⁸²³ noting that ‘quite a few industries have already signed up for this section; I don’t know if there will be enough space’,⁸²⁴ the comment that ‘big industries will be far away from the inner parts, which must be in total silence and peace. They must not be affected by smoke and noise from heavy machinery’ etc.)⁸²⁵ Medium to large scale enterprises of the sort contemplated have not developed in Auroville, owing to governance, capital and environmental concerns. These are practical concerns anticipated by Mother that require strategic planning and are not inconsistent with the ideal. As Thomas and Thomas pointedly note, this shift is necessary:

Auroville wants to develop in the direction of a full-fledged township, it will need a minimum of three to five units of medium size which, in India, means a turnover of between 250-1,000 crore a year. Auroville is far from that.’

This may be explored across adaptive and innovative tracks. Small and medium enterprises (‘SMEs’) in India have a ‘large (technology) adoption gap to close, by integrating proven practices and technologies, which is faster and safer than testing new ones.’⁸²⁶ This gap is clear in Auroville and presents an easy route to productivity increases, with significant SME growth potential in India (with Tamil Nadu as the third highest Indian state in terms of SME growth) and funding from central and state governments on the rise (SIDO, NSIC, MUDRA etc.).⁸²⁷ In this, management and executive training facilities will need to be developed to avoid the organizational flaws that typically limit SME expansion.⁸²⁸ However, innovative manufacturing presents an area of much potential for Auroville, given its research-oriented aspirations, in health foods, natural pharmaceuticals, medical and health technology, non-polluting transportation manufacturing and research, renewable energy manufacturing,. Given concerns with infrastructure development discussed in Part III.A, Ayer et. al. unsurprisingly identify the limited availability of ‘developed sites’ as a hurdle to start-ups.⁸²⁹

For this, Auroville may examine the feasibility of a ‘business / technology park’ / ‘Special Economic Zone’ model – though that will require a substantial commitment at scale – and the proposed ‘Auroville Commercial Status’ for external equity participants / donors, which will require modifications to the institutional architecture under the AVF Act, discussed below. Auroville may also explore the implications of the 2023 Tamil Nadu Logistics Policy and Integrated Logistics Plan, which lists Villupuram and Cuddalore as existing industrial clusters to benefit from the policy, and the 2021 Export Promotion Strategy, to develop supply chains.⁸³⁰ Similarly, the Tamil Nadu Life Sciences Promotion Policy, 2022 provides incentives for the

⁸²² Guigan, 2018, Vol. 1, 223.

⁸²³ Guigan, 2018, Vol. 1, 244.

⁸²⁴ Guigan, 2018, Vol. 1, 105.

⁸²⁵ Guigan, 2018, Vol. 1, 116.

⁸²⁶ Albaz. et. al., 2.

⁸²⁷ See, in general, Ministry of Micro, Small and Medium Enterprises, 2022-23.

⁸²⁸ Albaz. et. al., 8.

⁸²⁹ Ayer et. al., 2019, 8.

⁸³⁰ Industries, Investment Promotion and Commerce Department, Government Order No. 73, 2023.

biotechnology, bio-services and natural pharmaceutical industry sector, which require quick appraisal and movement within Auroville to leverage benefits.⁸³¹

Enabling this sector will thus require *prior* investment in capital and infrastructure (starting with the infrastructure corridors, energy lines (smart-grid) and water) and an effective and appropriate scaling-up strategy to reach desired, not unchecked, growth levels.⁸³² The laying down of the optical fibre communication network in 2015 is an important landmark.⁸³³ Revi's 2006 suggestion to examine green, high-value manufacturing options in anticipation of future demand is as valid today, indeed with a pressing insistence:

Pondicherry however, has a wide range of these enterprises and it may be useful to examine how the human resources of Auroville could also become a site for clean/green high value manufacturing e.g., high quality light engineering or the development of advanced biomaterials which in time could be important to enable the building of the urban fabric and the infrastructure of the 'city'. The creation of for the 'city' should be able to support a number of building related enterprises. If Auroville is able to set international standards in this area, this experience could provide commercial opportunities for green building and infrastructure, which will experience explosive demand growth in Tamil Nadu over the next few decades. This will need the steady development of appropriate infrastructure, technology, management skills and capital within Auroville.

Lastly, we may note that a strong manufacturing sector may also serve the economic imperative of the bio-region by generating large-scale employment, a continuing concern given a limited *in situ* industrial setup, outside of wage labour and daily, contract employment in Auroville.⁸³⁴ Interestingly, in an old formation for Auroville of 1938, later repeated in 1965, Mother had envisioned a 'labour colony' as part of the 'industrial section ... perhaps an extension on the edge of the industrial section' to house employees – this may be considered today, as a means for welfare for the local employees and to strengthen ties.⁸³⁵

d. Innovation Infrastructure and Clustering Dynamics

Auroville's research-oriented constitution naturally yields to innovation-led production through a flourishing entrepreneurial setup in the tertiary sector, a 'knowledge economy'. Developing catalytic sectors, including those listed above, and others aside (electronics, software development, artificial intelligence, machine learning of immediate value) can allow Auroville to (i) attract aligned (research-oriented, entrepreneurial) newcomers and capital, (ii) whilst building a market niche, and (iii) staying true to its ideal to 'spring boldly to future realizations.' The early rise of electronics and computing start-ups in Auroville, led by Aurelec Data Processing Systems, is a good case in point, with Aurelec micro-computers in production by 1980, ahead of the curve at its time.

⁸³¹ Industries, Investment Promotion and Commerce Department, Government Order No. 154/2002.

⁸³² Kalra, 2014, 16-7.

⁸³³ Auroville Foundation Annual Report, 2020-21, 32.

⁸³⁴ See, Sampathkumar, 2006.

⁸³⁵ Guigan, 2018, Vol. 1, 109.

The importance of cluster dynamics and a vital network with entrepreneurial activity elsewhere in India and globally to develop an innovation infrastructure will be key for Auroville's economic design.⁸³⁶ At its current scale and density, the benefits of urban agglomeration key for economic dynamism are unavailable to Auroville.⁸³⁷

To facilitate this transition, Auroville may consider: (i) strategic outreach to invite aligned newcomers with the technical and professional profile required for entrepreneurial activity, (ii) prior investments in housing, infrastructure (particular in identified catalytic sectors) and human resources to sustain an entrepreneurial culture, (iii) establishing a critical mass of 'leading' firms in strategic sectors, to attract and guide new residents and allow for clustering, spatial dynamics to emerge in the Industrial Zone, (iv) establishing incubators for these sectors with external support (suggested in ISP, 2013, ADP, 2013, IDPP, 2014, Ayer et. al., 2019, yet pending, with Saracon and the Integral Entrepreneurship lab as two notable exceptions, though not currently operational),⁸³⁸ and (v) examining options to overcome the legal and cultural obstacles to banking channels.⁸³⁹

The assistance of external advisors and partnerships with well-resourced technology universities / industry-linked arrangements (of the kind signed with Mahindra to manufacture compact electric vehicles) / international development organizations will be required to develop the necessary intellectual and material infrastructure to enable entrepreneurial activity. This is especially so in areas that demand large prior capital investments, as in medical science research, engineering, computing, green manufacturing, electronics etc., that are unlikely to result in the short term from internal revenue sources. Regional linkages with Pondicherry and the Tamil Nadu Green Climate Company in electric vehicle and renewables manufacturing may be valuable to explore, with the imminent implementation of the Tamil Nadu Electric Vehicle Policy, 2023 that will provide a strong fiscal and policy impetus to build capacity.⁸⁴⁰ The 2021 Memorandum of Understanding between the American Tamil Entrepreneurs Association and the State Government to establish a digital accelerator programme for start-

⁸³⁶ There is a vigorous and emerging literature on the subject. *See*, for example, Uqubay and Lin, 2020; Giuliano, 2019; Best, 2020; Royal Society, 2020; Breschi and Malerba, 2006; Duranton and Kerr, 2015; Lee, 2021. The proposed tertiary university frame for Auroville yields exciting possibilities in this direction, if embedded in the Industrial Zone. This point has been discussed in the community, but unfortunately with limited uptake. *See*, for example, Auroville Today, December, 2013, 3 ('One concern is that Auroville's units do not team up, which is the trend all over the world, as conglomeration is a key to success. Forming clusters has shown to benefit the units. Most Auroville units are micro and mini, not even medium leave alone large, and if they don't want to cluster, we predict problems. We also suggest that Auroville start a commercial think-tank to discuss these issues and plan for the future of Auroville's business sector. Auroville Entrepreneurs have been doing very well in substituting the Indian market for the diminishing exports, but competition is rising. Many units will need to diversify their products and start mechanising their production. For in 10-20 years, the Auroville commercial units will have moved out of the labour-intensive economy.')

⁸³⁷ *See*, for example, Braunerhjelm and Feldman, 2006.

⁸³⁸ *See*, for details on SaraCon, an early Auroville incubator, Thomas and Thomas, 2013, 170-3.

⁸³⁹ On the historical importance of clustering in the electronics sector in the 80s in Auroville, *see*, Thomas and Thomas, 2013, 29, 225,

⁸⁴⁰ Gastebois, *in* Arpi (ed.), 2015, 22. Industries, Investment Promotion and Commerce Department, Government Order No. 41/2023.

ups may also be explored to attract aligned talent and capital.⁸⁴¹ Proposals along these lines have been mooted for several years now, but with little movement. This is again concerning:

... when we sought clarifications there were many opinions, and very often there was no answer to a specific question or no decision was taken. That was frustrating. I think this is a particular problem here. At some stage a decision has to be taken; you can't endlessly debate.

'It's true that the Auroville entrepreneurs are facing difficulties which are not there for an outside entrepreneur. They have been detailed in our book. But what's distressing is that in all these years, Auroville has not found a solution to the problems. We are sounding the alarm as the survival of your income-generating units is at stake. You need to utilise your existing infrastructure (land), attract capital, attract entrepreneurs, and fight lethargy. Find solutions to overcome the specific problems due to Auroville's legal structure. You can't say that there is nothing you can do. You can!!'⁸⁴²

This transition to a knowledge economy will require, *inter alia*, a mindset shift from the cottage-industry setup to a capital intensive one. From our limited conversations, this has been a hurdle, with a general aversion to 'profit'-generation and large capital flows, neither of which are inconsistent with Mother's ideals. Indeed, they are required. Thomas and Thomas quote the founder of Aurelec Data Systems Processing, whose exit from Auroville after the passage of the AVF Act in 1988 generates important lessons for developing an inviting entrepreneurial climate given legal hurdles, which we discuss below:

Then, in 1986, Aurelec Data Processing Systems was created with high-tech electronics as its core activity. During the ensuing years, several professional Aurovilians were involved in the development and marketing of computer systems, with an outstanding role for one of its executives, Ulli Blass. Aurelec had finally been able to carve out a niche in India's emerging computer market.

Unfortunately, when the Auroville Foundation Act¹⁰ was introduced in 1988, difficulties arose between Aurelec and the Auroville Foundation, exactly at the time when Aurelec's entrepreneurs had to focus entirely on the new opportunities offered by the liberalisation of India's economy.

'The Foundation Act as it is expressed and interpreted is not hospitable to commercial activity in general and the computer business and information technology in particular', says Ulli. 'Problems such as those faced by Aurelec have largely to do with subjective perceptions of the economic life and how it has to be practiced by all, as decided by a few. Invariably, those who object to business activities will not be business people themselves. As such, they will never understand the realities and rules of the business world.' In his view: 'Such an attitude will also serve as a deterrent to future entrepreneurs. In the years to come Auroville will badly need a new breed of commercial entrepreneur. The days of the 'handicraft economy' are

⁸⁴¹ Industries, Investment Promotion and Commerce Department, Government Order No. 7/2021.

⁸⁴² Auroville Today, January, 2016, 7.

coming to an end. The Aurovilian entrepreneur of tomorrow will need to be a bold and brilliant type in order to cope with the exigencies of the new global market.⁸⁴³

In the long term, Auroville's economic profile will have to achieve a balance between primary, secondary and tertiary sectors (currently heavily reliant on small-scale secondary activity). This will require a conscious and planned policy framework, as anticipated by Mother's 'systems engineering approach' in the 1968 Ford Foundation Letter, in contrast to *ad hoc* activity that has been the norm. This has been a continuing gap: for example, back in 2007, Revi noted:

The primary future driver of Auroville's economy appears to be its Tertiary sector. This will however, need to be examined in the context of human development of Auroville, their ability to build enterprises and engage with the primary inner goals that they came to Auroville to fulfil. Given the small number of people that are currently available to take this forward, increasing the number of Newcomers, rapidly integrating them into the culture and functioning of Auroville and building a culture of drawing upon the resources of people of region will be useful to building a sustainable economic base. This will mean considerable pre-emptive investment in health, education and human development and enabling the expression of the impeccable quality that Auroville stands for among the younger people and communities in the bioregion.⁸⁴⁴

Our proposal for an expert-led, expert-constituted, independent and empowered group above may alleviate this concern, but institutional arrangements are bound to fail without an accompanying cultural shift in mindsets (and a policy restructure, which we discuss below) to welcome entrepreneurial activity, with increased capital inflows and a higher risk profile. This is needed to develop an innovation-led economic profile consistent with Auroville's highest aspirations. We may hazard to say that arriving in Auroville in the early years, faced with the challenge of regenerating the barren plateau, was a paradigmatically high-risk activity. Just as those pioneering works have yielded rich fruit, a leap of faith to green the economic landscape is now called for. A push to the future is needed for the commercial sector:

[Q: Firstly, is there something specific being done which is impeding the flow of money to Auroville?]

It is the lack of push towards the future that impedes the flow of money.⁸⁴⁵

e. Governance Restructure

In the early years, economic decision-making was in principle centralised in the Committee on Administrative Affairs established by the Mother. Post the conflict with the Sri Aurobindo Society, this committee gave way to a series of loosely coordinated enterprises – several collective sharing experiments (beginning with Pour Tous, Seeds and Envelopes) and some small commercial enterprises came up organically to address basic sustenance concerns. Until

⁸⁴³ Thomas and Thomas, 2013, 169.

⁸⁴⁴ Revi, 2007, 8.

⁸⁴⁵ Guigan, 2018, Vol. 1, 285.

the 1980s, no formal or professionally-managed agencies or groups had been created. Nor indeed was long-term economic planning or resource management a priority (aside from the considerable capital of environmental resources, which were painstakingly developed and zealously guarded), especially given small population numbers and what appears to be a general aversion to capital-intensive commercial activity or ‘profit’-generation.

The need for a structured approach to economic planning emerged (in a small way) as an immediate reaction to the financial non-viability of the ‘no-money-circulation’ ideal in Pour Tous. This led to the creation of the Financial Development Group in 1982, which was successful in instituting financial surveys and raised, for the first time, important questions about the nature and character of Auroville’s economic future. Alongside, the Financial Group emerged as an incipient attempt at institutional planning, though it appears within a fairly dissipated environment that resisted this ‘centralization’. A plethora of bodies emerged in the following years – by the end of the 1980s, the ‘Auroville Economy’ seminar had resulted in the formation of an Economy Group, Economy Study Group, Economy Task Group (later the Enlarged Economy Group and New Economy Group) which led studies to understand and estimate the community’s needs and aspirations for economic growth.

Subsequently, the passage of the AVF Act in 1988 created an environment of urgency among Aurovilians to ‘re-formulate Auroville’s short-term and long-term objectives’, as a reaction to fears of external intervention.⁸⁴⁶ Accordingly came the ABC, later the FAMC, BCC, Maintenance Fund and Central Fund. Several important policy and planning documents emerged around this time – notably those by Hemsell (a detailed study of integrated development strategies), Dhanya (plan for the Industrial Zone), Lamba (proposal for an Auroville Bank), Guigan and Thomas (both on planning in the economic sector). But no economic plan, or identification of growth strategies, as such seems to have been finalized. By most accounts, the development of the Industrial Zone was not a priority. In the following years, till date, economic planning was in the hands of the FAMC and BCC, alongside several commissioned studies, with the ABC and Auroville Board of Services (‘ABS’) playing a minimal role.⁸⁴⁷ Progress has been registered in terms of a professionally managed system of centralized accounting, a participatory budgeting process and policy interventions by way of the 2017 Code of Conduct (subject to concerns, as we discuss below). Yet no strategic thinking on economic growth – of the kind anticipated by the Ford Foundation letter in 1968 – by way of an economic development plan for the Industrial Zone has emerged, with commercial units starting and operating independently largely through individual, uncoordinated effort, in many cases as a response to sustenance concerns. Majumdar’s remark made in 2017 holds true today:

At present, the Industrial Zone is a haphazard area, which no clear direction, and offers little sign of evolving to a strong productive sector it was meant to be ... Apart from a few steady, major contributing units like Maroma, most Auroville units are

⁸⁴⁶ Thomas and Thomas, 2013, 83.

⁸⁴⁷ See, Auroville Foundation, 2013-14, 20-21, for the mandate of the ABC, which concerns coordination, advising on appointment of executives, auditing assistance etc.

mid-scale to small-scale cottage industries that cannot serve in the building or in sustaining the city.⁸⁴⁸

What seems to have been missing in Auroville in these myriad developments is (i) a cohesive plan (or indeed, a formal recognition of the need) to develop the commercial and industrial sector at sufficient scale and productivity, (ii) with strategic and guided investments and policy interventions to generate a legal and cultural environment conducive to entrepreneurial or research-oriented commercial activity,⁸⁴⁹ and (iii) an empowered, professionally competent and centralized institution to plan and execute these works in a time-bound manner, with external advice and input. As Thomas and Thomas bluntly note:

There could be no real perspective on a feasible route towards ‘the city of the future’ if the rather ad-hoc decision-making procedures – with some ‘anarchistic’ leanings would not, at least in the most strategic parameters, be complemented with systematic policy making at a central level of coordination, dialogue and decision-making ...⁸⁵⁰

At a philosophical level, it is interesting to map these developments to Chapter XX of Sri Aurobindo’s *Ideal of Human Unity*, ‘The Drive Towards Economic Centralization’.⁸⁵¹ Briefly, Sri Aurobindo outlines a teleological movement from a loosely organized, customary mass of practices, organically developed over time in response to ‘changing ideas and more and more complex necessities’ to a ‘rational development’ which comprises ‘the creation of a central authority, – a distinct central force but afterwards more and more conterminous with the society itself or directly representing it, which gradually takes over the specialised and separated parts of the social activity.’ This ‘unified control’, or rationalization, if well-organized – be it legislative or executive, the Residents’ Assembly or the FAMC (both yet loosely organized) – allows for the ‘development of the society as an organism consciously and entirely legislating for its own needs.’ Elsewhere, Sri Aurobindo notes the gains that lie in this movement:

And certainly the external efficiency of the community, the measured, ordered and economical working of its life, its power for production and general well-being must enormously increase, as even the quite imperfect development of collective action in the recent past has shown, in a well-organised and concentrated State.⁸⁵²

We can see what it gained, an immense collective power and a certain kind of perfection and scientific adjustment of means to end and a high general level of economic, intellectual and social efficiency.⁸⁵³

⁸⁴⁸ Majumdar, 2017, 258.

⁸⁴⁹ In this vein, early planning documents envision the creation of a technical college in the economic zone along with a skilling centre in every unit.

⁸⁵⁰ Auroville Today, January, 2016, 7.

⁸⁵¹ Sri Aurobindo, CWSA, 1997, Vol. 25, 445-50.

⁸⁵² Sri Aurobindo, CWSA, 1997, Vol. 25, 208.

⁸⁵³ Sri Aurobindo, CWSA, 1997, Vol. 25, 49.

Independently, Sri Aurobindo also notes, a matter of much relevance to Auroville today, the importance of such economic centralization in engendering a more cohesive social fabric, a vital association of residents that may later lead to a spiritual one:

Economic unification needed –, a common economic life dependent on that geographical oneness and the sentiment of the motherland which grows up around the physical and economic fact and either creates a political and administrative unity or keeps it to a secure permanence once it has been created ... In order that it may impose itself, there must be a considerable force of the second natural condition, that is to say, a necessity of economic unity or habit of common sustenance.⁸⁵⁴

Naturally, in this centralization of powers lies a risk:

But that authority in its impulse towards an undivided and uncontrolled gestation, a complete unification of powers must naturally desire not only to determine the expenditure according to its own free will, but to determine also the contributions of the society to the public purse both in its amount and in its repartition over the individuals and classes who constitute the nation.⁸⁵⁵

In response, Sri Aurobindo highlights that the ‘completeness of the process’, that of substituting a loosely organized set of customary practices to an intelligently and consciously self-regulating society, ‘depends on the completeness of the development by which the State and society become, as far as that may be, synonymous’, through the depth of democratic engagement. In other words, how closely associated or representative the Residents’ Assembly or FAMC, in this context, can be of the social fabric of the Auroville community.

This dynamic, discussed at length in the literature, requires a far fuller discussion – an important area for Auroville’s research landscape.⁸⁵⁶ Yet, it maps on quite distinctly to Auroville’s incipient governance frame, even at the small scale of its operation currently in terms of revenue and population numbers. The ‘drive towards economic centralization’, a unified and coordinated effort, is necessary and indeed inevitable, to allow for conscious self-regulation, i.e., to meet the ideals of self-sustenance and city-building. Naturally, the power to ‘control’ expenditure and ‘regulate’ contributions (as in the 2017 Code of Conduct, for example) must be adequately addressed, to present enterprise freedom: ‘[but] even so it is questions, not of taxation [‘contributions’ in this case], but of the proper organisation and administration of the economic life of the society which are preparing the revolutions of the future.’⁸⁵⁷ The task thus is to identify a ‘proper organization’ of Auroville’s economic life through (i) an appropriate centralization of economic administration, (ii) that can consciously direct energies to ‘provide for its own needs’, that of self-sustenance, city-building and innovation-led enterprise, (iii) by taking over this ‘specialised ... social activity’ through an

⁸⁵⁴ Sri Aurobindo, CWSA, Vol. 25, 324-6.

⁸⁵⁵ Sri Aurobindo, CWSA, Vol. 25, 449.

⁸⁵⁶ We consider this dynamic in Part IV.C for governance practices across sectors based on our empirical picture here, with reference to the *Ideal of Human Unity* and other literature.

⁸⁵⁷ Sri Aurobindo, CWSA, Vol. 25, 450.

expert-led body, that is (iv) yet consultative and in tune with the social fabric, and (v) careful to maintain the freedom of commercial units to grow, invest and adapt.

At a practical level, what this can translate into is an empowered and professionally competent Working Group, the Economic Planning Group, with streamlined and simple governance mechanisms, organized along the following lines:

- i. *Executive*: the body must have powers of planning and implementation, independent of the legislative mandate of the Residents' Assembly, to effectively take control of this 'specialized ... social activity', which demands domain expertise. While policy decisions – as to the guiding principles and general direction of the sector – may be legislated through a Residents' Assembly Decision (an important and missing part of the governance picture), planning and execution of tasks must be within the independent domain of the executive body. The lack of clarity on this legislative – executive distinction in the economy has had adverse consequences for planned growth and strategic choices.⁸⁵⁸ This is recognized in principle in the mandate of the FAMC, which requires it to 'formulate financial and economic policies that support the FAMC's mission. Such policies will be submitted for approval by the Resident's Assembly. The FAMC may make regulations to execute an approved policy.'⁸⁵⁹ However, in practice, this referral to the Residents' Assembly – to the limited extent this channel has been effective – has not been on policy matters, but all matters, including those of planning and execution of works. With limited powers of execution and technocratic expertise, accountability has been limited. This is a concern across Working Groups, as we discuss in more detail in Part IV.B.
- ii. *Empowered and consultative*: in this, the body must have a clearly defined executive mandate that explicitly empowers it to plan, consult and implement. Consultative mechanisms, particularly with commercial and service units, through the ABC and ABS (if revived), are critical to allow for the synonymy between 'state' (FAMC / Economy Working Group) and 'society' (residents) to develop, discussed above with reference to Sri Aurobindo. A clear and effective channel between firms and the regulator / governing body is necessary for policy to translate into an enabling environment for economic activity, currently a concern. Consultations with other members of the community at large may also be conducted. Yet, given the principle of 'illuminated hierarchies with collective discipline', participatory inflation must be guarded against, with the body empowered, after due engagement, to take decisions. Accountability is ensured through the selection process at the end of the term after implementation, not

⁸⁵⁸ See, for example, Full Report, Auroville Retreat, 2015, 19 (in the 'economy' track, '... need to clarify the role of the RA and make it more effective. Define some 'Rules of the Game' for how we work together in the RA. We need to define the roles/relationship between the RA and the Working Groups.') This task is pending. We discuss this in Part IV.B.

⁸⁵⁹ Mandate of the Finance and Asset Management Committee, 2016, 1.

through hindering implementation absent a universal consensus. By most accounts, the lack of executive power (or as we discuss in Part IV, ‘committee packing’ that results in deadlocks) to effectively implement on-ground actions awaiting a vaguely defined consensus has created disincentives for talented individuals / residents to take up positions in Working Groups. Ayer et. al., for example, note that Working Groups have been ‘unable to engage and retain skilled HR in ... economy’, with ‘lack of domain capacity in the nominated members [which] prevents institution building.’⁸⁶⁰ Generating a robust commercial and industrial sector requires stability and signalling, which comes with institutional and policy continuity maintained over time, difficult in the current system.

- iii. *Stable*: the introduction of various bodies since 2001 – approximately 8 by our measure – with an unclear scope and mandate of work, has introduced instability into the planning system. The 2015 Retreat had suggested that ‘groups should be formed for a specific task and for a specific duration, after which they dissolve until the next clearly defined task appears.’⁸⁶¹ With respect, we consider this to be a sub-optimal strategy, as it invites institutional discontinuity. Developing the commercial sector depends on generating trust in incoming residents and capital, which requires a stable, professional and permanent single window body. The Retreat also notes, contrary to this suggestion, though no resolution is finally suggested, ‘ad-hoc decision-making to be replaced by decision-making based on values, plans, criteria, priorities and time lines.’⁸⁶² The latter approach is preferable.
- iv. *Qualified*: as with any executive function, and economic planning more so, the work of this body requires professional expertise in fields of business, industry, finance and banking, entrepreneurship, economic and social policy etc., as will need to be carefully defined, with inducements and outreach to draw people with such skills to Auroville. It must therefore be chosen based on demonstrated qualifications / expertise in these fields, through an expert-led selection mechanism. This would require a reconsideration of the Participatory Working Groups and their Selection Guidelines currently in place, that provide for an anonymous popular-vote, with a part ‘lottocracy’.⁸⁶³ The process for selection must bear a rational nexus to the nature of the body being selected: an expert-led selection process is thus preferable to a well-intentioned popular vote. As we suggest in Part IV with reference to all Working Groups, an expert-led and competence-based selection process run independently by the Residents’ Assembly Service is better suited to these groups, with the Residents’ Assembly selecting for its own part one member through current practices to ensure accountability with policy directions and allow for a feedback loop to the Assembly.

⁸⁶⁰ Ayer et. al., 2019, 28.

⁸⁶¹ Full Report, Auroville Retreat, 2015, 19.

⁸⁶² Full Report, Auroville Retreat, 2015, 19.

⁸⁶³ We discuss this in Part IV.C in more detail.

- v. *Independent and dedicated*: the tasks outlined above for this body are currently within the mandate of the FAMC under the 2016 Residents' Assembly Decision. The mandate lists 23 'responsibilities' across land and estate management, commerce and industrial activity, accounting, auditing and planning to secure a just distribution through the yearly budgeting process (under the BCC), oversee the functioning of the Unity Fund, Auroville Maintenance and the Central Fund, approve loans, land leases and the sale or exchange of buildings, houses, machinery and equipment and any other asset, oversee functioning of all trusts, units and land stewards, with powers of appointment and removal, approve contracts, loans and other debt obligations taken on by units, manage housing (through the Housing Board), conduct internal audits and maintain a consolidated register of assets and prepare the Consolidated Balance Sheet etc. Alongside, it is required to 'identify, encourage, and support the growth of commercial activities that have the potential to bring significant revenues to Auroville.'⁸⁶⁴ It is difficult to imagine a single body, even with defined sub-groups (BCC, Housing Board etc.), effectively conducting these tasks, particularly as many of these require a different set of competences / qualifications. Accordingly, an independent body tasked with the growth of the commercial, industrial and service sector, an important and standalone task in itself, with appropriately identified qualifications may be considered to allow it to dedicate the necessary time and effort to develop a self-sustaining economy. This body be named accordingly from any of the several past names proposed.
- vi. *Zonal*: as we discuss in Part IV, an effective governance architecture requires a confederated setup, with strong zonal and sub-zonal bodies such that all matters are not referred to the Residents' Assembly (as is the case under its current mandate, p. 3) or to centralized Working Groups. Where they can be devolved or dealt with at the zonal level, they should be. As commercial and industrial development (as opposed to city-service budgeting and distribution) is concentrated in the Industrial Zone, this body can be the Zonal Group. Zonal Groups were constituted in 2004, yet with limited success. The ABC and ABS, attempts at sub-zonal organization too subsided. The effective coordination and clustering of those involved in the sector, for economic as much as cultural reasons, requires a cohesive fabric – as such, this body can be the Zonal Group, organizing and representing works in the sector and zone. If so, development-based competences / roles will have to be added to its profile in addition to those identified earlier. This body may also consider reviving / instituting *sub*-zonal bodies, ABC, ABS, Incubation Centre, SME Council etc., to develop a well-organized architecture at the level at which units, firms, employees etc. can effectively engage, cluster, share resources and guide policy making in real time. The current arrangement introduces a fair bit of lag and process in the system, with delayed feedback loops and an unnecessary centralization with entry barriers to start-ups. We propose a rough sketch of this zonal architecture in Part IV.

⁸⁶⁴ Mandate of the Finance and Asset Management Committee, 2016.

- vii. *Accountable, with light but tight reporting*: the current mandate of the FAMC requires it to publish a monthly and annual report, publish an annual work plan with ‘expected results’, conduct a yearly review as against the work plan and meet with the Residents’ Assembly on a quarterly basis. We are informed these practices have not been maintained with regularity. As we noted above, given extremely low participation rates in the Residents’ Assembly, and limited competence in commercial and industrial matters, the rationale and effectiveness of this fairly enormous reporting mechanism (a quarterly meeting) may be reconsidered. In interviews, it appears that lack of executive power to implement has dented accountability, with an in-paper mandate on this count. Accountability mechanisms by way of regular, automated and light reporting process through the Governance Dashboard suggested in Part IV can be instituted, with the Residents’ Assembly nominee in the FAMC / proposed Economy Group serving to ensure broad policy compliance. In general, reporting mechanisms must be streamlined and tied to clearly defined feedback loops to bodies that are competent and able to render such advice / checks, to avoid creeping bureaucratic burdens.
- viii. *Open*: this body can constitute an external advisory board, as we suggest for all Working Groups in Part IV, to leverage expertise. This open orientation is central, particularly in relation to keeping in tune with market dynamics and emerging opportunities. There is a policy recognition of this factor in the 2017 TDC Terms of Reference which notes that the ‘criteria for development in the international zone are to be reviewed taking into account current global contexts’.⁸⁶⁵ Auroville has limited internal capacity in sectors where diversification can take place (industrial, manufacturing, tertiary sectors, tech-incubators etc.), for which aid and advice from aligned experts can be solicited. Previous external input, in Thomas and Thomas, 2013 ISP, 2014 IDPP etc. seems to have met with limited uptake, which is concerning.

The expansion and diversification of the commercial profile of Auroville’s economic setup will require strategic planning to be anchored by the proposed body. We briefly outline some considerations that emerge in relation to this task, each of which require further research and detailing out.

f. Reconsidering the 2017 Code of Conduct

Generating a thriving commercial sector along the lines discussed above, and in various other studies, will require an enabling regulatory framework. This is so on several levels. As a preliminary remark, we may note that despite repeated studies since and including the Masterplan indicating structural concerns, with declining surplus and low productivity, no policy-action has been registered. This in itself is a serious flaw in governance practices that requires urgent action. Our proposal above for an independent and empowered expert-led and

⁸⁶⁵ TDC Terms of Reference, 2017, 2.1.1.10.

expert-selected body / Working Group can be one pathway to generate a more responsive and competent governance frame. However, there are other significant entry and operational barriers that require reconsideration.⁸⁶⁶ The 2017 Code of Conduct currently in effect stipulates as follows:

- i. Unit executives are to be appointed jointly by the FAMC / Working Committee for a period of five years, under rule (8).
- ii. FAMC / Working Committee have the power under rule (9) to remove an executive if ‘mismanagement’ is proved, after natural justice, if they are ‘of the view that in the larger interest of the community a change or removal ... has to be effected’ or if they are of the view that the remaining executive are ‘not capable of managing the unity’ after a vacancy. Alongside rule (12-a) empowers the FAMC ‘to order an investigation into the accounts and general management of a Unit and suspend the Unit Executive(s) pending such investigation.’ Units may be closed if ‘mismanaged’ or if the FAMC and Working Committee ‘are jointly of the view that closure of the Unit is in the interest of the community.’
- iii. The executives shall manage the unit ‘autonomously’, but under rule (10) they are (a) ‘subject to the general superintendence of the Auroville Foundation and shall abide by all directives that may be issued from time to time by the Governing Board’, (b) subject to the FAMC, who ‘shall oversee the functioning of the ... Units and may take *any action* as is required’, which the executives ‘shall abide by’, (c) ‘the surplus income of the unit shall be utilized only to further the aims and objectives of Auroville’.
- iv. Units are subject to the Management Committee of the Trust under which they are created *and* the FAMC, who shall normally not intervene in the day-to-day management of the units. However, under rule (11), the FAMC may temporarily intervene if it determines that the Executives of a Unit require assistance and may appoint a management committee to assist the unit in the interim. In such a case, the FAMC will document the reasons, establish a time frame or criteria to be met to return the unit to autonomous management.
- v. Rule (11-c) further stipulates the unit may only undertake a new activity, which is not specifically mentioned in the FAMC Resolution for creation of the Unit, after having received the prior written permission of the BoT [Board of Trustees of the Trust under which the unit functions] and FAMC.

⁸⁶⁶ These issues have been raised in the community. *See*, for example, Auroville Today, November, 2020, 9 (‘One of the most controversial issues is the Code of Conduct which was introduced in Auroville four years ago. Its opponents believe that it will, among other things, increase bureaucracy regarding the functioning of Auroville’s units.’)

- vi. Rule (11-e to n) stipulate that an executive can open independent bank accounts subject to a resolution from the BoT. Units may create financial liabilities up to 25% of the capital fund of the unit, with FAMC permission required beyond that amount. The unit may acquire immovable assets in the name of the Auroville Foundation only with the approval of the FAMC and the Secretary of the Auroville Foundation, but ownership is retained with the Foundation. All transfers of immovable property further require FAMC approval. Agreements with external entities that create financial liabilities which exceed 50% of the previous year's turnover require FAMC approval. Any lease or rent of immovable properties not owned by the Foundation over 10% of the previous year's turnover requires FAMC approval. Any lease or rent of properties belonging to the Foundation (in effect all properties stewarded by the unit) requires approval from the BoT and FAMC, including for extension (with a three-week presumptive approval). Any capital investment above 25% of the capital fund of the unit requires BoT approval, and above 100% requires FAMC approval.
- vii. Rule (11-o) stipulates contributions as outlined earlier, at 33% for commercial units. 'Specified' contributions by units to other entities in Auroville, a cultural practice with solidarity-generating effects historically,⁸⁶⁷ are only permitted if the receiving unit has fulfilled its own contribution mandate, with approvals between 1-10 lakhs requiring BoT approval and those above 10 lakh requiring FAMC approval. Contributions / donations to entities outside entities, a reciprocal ideal given substantial grants and donations received by Auroville, it seems are not permitted.
- viii. Rule (11-p) requires legal disputes to be reported to the BoT and FAMC, with regular updates for statutory filing with the nodal ministries of the Central Government.

More information on the working of the Code would be required to make a detailed assessment, including exemptions granted, processes and timelines for approval by the BoT / FAMC, nature of scrutiny / internal capacity to evaluate, relationship of social capital / networking to approvals processes and a survey of unit executives on ease of doing business. That said, it is hardly imaginable that these severe limits on enterprise freedom will attract or retain newcomers or residents (entrepreneurs, in MSME-large scale manufacturing, innovation-led start-ups or professional services) necessary for the growth of the Industrial Zone. With centralized appointment / removal of executives, vaguely defined powers to close or alter units 'in the interest of the community', restrictions on access to capital, prior approvals for loans, leases, investment, voluntary contributions, contracts and general superintendence powers to take 'any action' as deemed necessary, all subject to a four-tiered approval process by the BoT, FAMC, Secretary to the Foundation and Governing Board, as the case may be, the Code of Conduct introduces a heavy compliance burden and limits operational capacities that sit uneasily with commercial freedoms required in an entrepreneurial landscape. Equally, the invariable and heavy contribution requirements disallow / disincentive reinvestment,

⁸⁶⁷ Clarence-Smith, 2019, 192-7.

particularly for early-stage companies / those in a growth cycle and discount depreciation concerns.

There seems here to be a twin regulation of economic solidarity and of economic growth. A good historical benchmark to measure the 2017 Code is Mother's 1968 Ford Foundation letter, which anticipated 'inducements' for commercial enterprises to participate in Auroville, indicating, as literature amply notes, the need for enterprises to have the freedom to operate, innovate and undertake risk within an enabling regulatory environment.⁸⁶⁸ Units ultimately are closest to the enterprise and best able to judge the most appropriate growth and investment strategy – 'mismanagement' / 'blatant mismanagement' (terms that requires defining in the Code) aside, preserving this freedom is critical to the growth of Auroville's economic sector. The bureaucratic inefficiencies and moral hazards that result from centralized economic management, as opposed to what the literature refers to as 'smart regulation', are well documented. Ayer et. al.'s pointed remarks on the current regulations are thus apt:

The present structure for economic development disincentives growth and employment generation. This coupled with the policy of a universal 33% contribution, prevents and penalizes investment in development echoing the license raj period of India. Not undertaking (sic) exercise of categorizing the economic activities by size, activity type and cycle will result in the best-case scenario of a stagnation of economic growth & development and in the worst-case scenario, a hidden and underground network of exchange of goods & services and asset creation to survive.⁸⁶⁹

Thomas and Thomas' review of Aurelec discussed above is a good case in point, from which learnings may be had. The necessary and needed 'drive to economic centralization' applies to strategic planning and outreach in catalytic sectors, infrastructure development, incubation and enabling credit, *not* management, operation, and strict capital regulation, as is, albeit unwittingly, the case currently. The former is necessary to address the historical trajectory and current scheme of uncoordinated *ad hoc* development of commercial units. Yet, in attempting to develop the 'proper organisation and administration of the economic life of the society which are preparing the revolutions of the future', a high and distant ideal, Auroville must be careful to restrain the contrary 'impulse towards an undivided and uncontrolled gestation', as Sri Aurobindo put it, reflected unwittingly in some measure in the 2017 guidelines:

It is the individual who demands liberty for himself, a free movement for his mind, life, will, action; the collectivist trend and the State idea have rather the opposite tendency, they are self-compelled to take up more and more the compulsory management and control of the mind, life, will, action of the community and the individual's as part of it until personal liberty is pressed out of existence.⁸⁷⁰

This requires centralized, 'smart' regulation to develop incentives and make capital / infrastructure available for catalytic sectors, but maintain enterprise freedom for operational

⁸⁶⁸ See, for example, Messaoud and Teheni, 2014; Kjaer and Vetterlein, 2018.

⁸⁶⁹ Ayer et. al., 2019, 8.

⁸⁷⁰ Sri Aurobindo, CWSA, 1997, Vol. 25, 203.

decisions. To achieve this balance between ‘smart regulation’ and enterprise freedom, a closer look at the AVF Act, 1988 is needed especially pertaining to the issue of non-ownership. The terms of ownership of commercial assets, both in its legal meaning (as used in the AVF Act) and spiritual content (as used in the Charter) has a bearing on the economic performance of these units – it determines the level of autonomy unit heads have in the running and operating their units, which in turn bears on an appropriate regulatory structure to attract talent and investments in the future.

The principle of non-ownership under the AVF Act, 1988, a legal translation of the Charter, must be careful to avoid the regulatory excesses that collectivist settings are prone to, as in the 2017 Code:

... right in property is to exist, and therefore socialism abolishes — except at best on a small scale — the right of personal property as it is now understood and makes war on the hereditary principle. Who then is to possess the property? It can only be the community as a whole. And who is to administer it? Again, the community as a whole. In order to justify this idea, the socialistic principle has practically to deny the existence of the individual or his right to exist except as a member of the society and for its sake. He belongs entirely to the society, not only his property, but himself, his labour, his capacities, the education it gives him and its results, his mind, his knowledge, his individual life, his family life, the life of his children. Moreover, since his individual reason cannot be trusted to work out naturally a right and rational adjustment of his life with the life of others, it is for the reason of the whole community to arrange that too for him. Not the reasoning minds and wills of the individuals, but the collective reasoning mind and will of the community has to govern. It is this which will determine not only the principles and all the details of the economic and political order, but the whole life of the community and of the individual as a working, thinking, feeling cell of this life, the development of his capacities, his actions, the use of the knowledge he has acquired, the whole ordering of his vital, his ethical, his intelligent being. For so only can the collective reason and intelligent will of the race overcome the egoism of individualistic life and bring about a perfect principle and rational order of society in a harmonious world. It is true that this inevitable character of socialism is denied or minimised by the more democratic socialists; for the socialistic mind still bears the impress of the old democratic ideas and cherishes hopes that betray it often into strange illogicalities. It assures us that it will combine some kind of individual freedom, a limited but all the more true and rational freedom, with the rigours of the collectivist idea.⁸⁷¹

Two senses of the word ‘collectivism’ can be distinguished here: the first is in its *formal* sense in socialist settings, as abolishing the legal right to private property in the ‘collective’ (managed in reality by an executive minority, as it must be to some measure), a situation precipitated by the AVF Act, 1988 and the 2017 Code. And the second is in its *spiritual* sense, as an internal offering to the Divine, a Vedantic socialism. There are thus two related factors to consider here: legal, relating to the AVF Act, 1988 and moral, cultural or spiritual, relating to Mother’s guidance.

⁸⁷¹ Sri Aurobindo, CWSA, 1997, Vol. 25, 201.

The AVF Act, 1988 nationalized all properties and assets of the Sri Aurobindo Society and thirteen trusts extant at the time listed in the Schedule to the Act. Accordingly, the minutes of the 20th meeting of the Governing Board in August, 1999 record that all pre-existing trusts were re-registered under the Auroville Foundation.⁸⁷² Subsequently, various other trusts have been established under Section 20(4) – the Annual Report of the Auroville Foundation for 2018-19 records 36 existing trusts with 179 units. We were unable, either through documents or interviews, to ascertain the precise legal status and operational necessity of such umbrella trusts, as opposed to independently incorporated entities. In relation to the commercial sector, movable and immovable properties and other assets are owned by the Foundation, but stewarded by individual units and executives under the immediate guidance of the Management Committee of the Trust appointed by the FAMC. This is a practical manifestation of the principle of ‘no-ownership’ enshrined in the Charter, discussed in Part I. This is a critical feature to consider: a leap of faith required to practice the ‘non-ownership’ principle, in *essence* an internal offering to the Divine (with no necessary nexus to the institutional architecture), but in *practice*, a formal, if not operational, transfer of control over the enterprise to the centralized administration of the collective, run by a minority of office-bearers in the four-tiered structure.

As Thomas and Thomas (in quoting Blass), Ayer et. al. and our limited interviews in the sector indicate, there is a *prima facie* tension between the legal architecture and commercial freedom to start, operate and grow enterprises in terms of a heavy centralization of approvals, appointment, capital flows, investment decisions etc. Operating this system, to generate sufficient inducements for newcomers and external capital and credit, requires a degree of trust in the centralized administration (in principle the entire collective aspiring to the Divine, in practice, the FAMC and other office-bearers). For one to offer one’s energy, time and capital to the Divine is one matter, to legally ‘donate’ it to the Foundation is another. For the two – internal offering and legal donation – to be synonymous, the office-bearers of the centralized administration must have the ‘clearest, most comprehensive and truest vision’ (a point that generates strong reasons in favour of the expert-led, expert-constituted selection process for the independent ‘Economic Planning Group’ proposed above, as opposed to a popular vote, an ‘illuminated (financial) hierarchy’):

This idea of *possessing* money has warped everything. Money should not be a ‘possession’: like power it is a means of action which is given to you, but you must use it according to... what we can call the ‘will of the Giver’, that is, in an impersonal and enlightened way. If you are a good instrument for diffusing and utilising money, then it comes to you, and it comes to you in proportion to your capacity to use it as it is meant to be used. That is the true mechanism.

The true attitude is this: money is a force intended for the work on earth, the work required to prepare the earth to receive and manifest the divine forces, and it—that is, the power of utilising it, — must come into the hands of those who have the clearest, most comprehensive and truest vision. But if people understood that one should be

⁸⁷² 20th Meeting of the Governing Board, Auroville Foundation, 1999, 2-3.

like a receiving and transmitting station and that the wider the range (just the opposite of personal), the more impersonal, comprehensive and wide it is, the more force it can hold ('force' that is translated materially: notes and coins). This power to hold is proportional to the capacity to use the money in the best way—'best' in terms of the general progress: the widest vision, the greatest understanding

But, naturally, the need is for very clear heads and for intermediaries of high integrity (!) to be able to be everywhere at the same time and do all at the same time. Then this famous question of money would be solved.

Money belongs to no one: money is a collective property that only those with an integral and general, universal vision must use. And let me add, a vision not only integral and general, but also essentially true, which means you can distinguish between a utilisation in conformity with universal progress, and a utilisation that might be called fanciful.⁸⁷³

As a philosophical matter, renunciation of possession, the key principle, is internal (to the Divine), not external (to the Foundation).⁸⁷⁴ The inner renunciation may manifest in various forms, yet to make inner ('truer, deeper', subtler) law coincide with the outer (policy) specification is the big challenge in practice that Mother outline – to institutionalize the principle of non-ownership:

... there is one thing I wanted to say. One's participation in the welfare and existence of the whole township isn't something worked out individually: such and such an individual must give so much. It's not like that. It's worked out according to one's means, activity, possibilities of production; it's not the democratic idea, which cuts everything into small equal bits – an absurd machinery. It's worked out according to one's means: one who has much gives much, one who has little gives little; one who is strong works a lot, one who isn't does something else. You understand, it's something truer, deeper. And that's why I am not trying to explain it right away, because people will start making all kinds of protests. It must come into being automatically, so to say, with the growth of the township, in the true spirit.⁸⁷⁵

This could be a complete handover, legally handing over operations and administration to an external authority. Or it could mean that a retention of legal ownership and administration, such that the unit head, who has the clearest vision for the unit, continues to retain control. This may still be considered as non-ownership, gauging the spirit in which the unit is owned and run for the collective good. Or, it may be collectively owned, but individually operated as an offering, where the unit head is not the owner but is a steward who can, either continue retaining funds and determine their use or handover funds (or turnover or profit), with investment and expenditure decisions left to the collective. Within these rough possibilities, the first is naturally

⁸⁷³ Guigan, 2018, Vol. 1, 271-4 (emphasis in original).

⁸⁷⁴ Sri Aurobindo, CWSA, 1997, Vols. 23-24, 327 ('Again our renunciation must obviously be an inward renunciation; especially and above all, a renunciation of attachment and the craving of desire in the senses and the heart, of self-will in the thought and action and of egoism in the centre of the consciousness.');

⁸⁷⁵ Guigan, 2018, Vol. 1, 223.

to be avoided, yet variations of the second and third are in play. A broader interpretation of non-ownership under the AVF Act may be helpful thus to liberalize the sector, with regulatory oversight but not control.

It may just be, indeed likely is, that the ‘widest vision’ lies with the unit executive, such that it may not (in principle) be necessary to legally donate all assets, income to the Foundation to practice the principle of non-ownership in the Charter. This is particularly so as unit executives are closest to their enterprise, and best placed to determine growth and investment strategies. Put another way, the opposite of the idea of possession is not contributing to the Central Fund, but offering to the Divine, as manifested in the collective, whether the funds remain in one’s control or are handed over to the collective. The former may just as well practice the ideal of non-ownership. The underlying idea, to push the point a bit further, is that there is no necessary coincidence between the Divine and the collective / Foundation. But there may need to be a *practical* one to make the experiment feasible – when residents / unit heads consent to participate in the collective experiment, they offer in a spirit of service to the collective / Foundation, knowing that it is still a ‘corporate ego’ that does not coincide with the Divine, but serves as a necessary placeholder, a vehicle to get there, to find the ‘group-soul’ that is truly a Divine *sangha*. Defining the scope of this institutional offering is the practical problem facing Auroville.

In this, it bears noting that the conflation of a fraternal self-offering with collective administration is an old play (leading possible to a typical order of economic rationalism, in Sri Aurobindo’s terms) and one that must be approached with caution as Auroville expands and matures its economic setup. As Sri Aurobindo pointedly notes, in a remark that we can map onto the current debate in Auroville, the necessity of an underlying fraternity, with legal forms (whether owned by the Foundation or a residents) being, in the ideal, a secondary matter:

But if both equality and liberty disappear from the human scene, there is left only one member of the democratic trinity, comradeship, that has some chance of survival as part of the social basis. This is because it seems to square better with the spirit of collectivism; we see accordingly the idea of it if not the fact still insisted on in the new social systems ... But comradeship without liberty and equality can be nothing more than the like association of all individuals, functional classes, guilds, syndicates, soviets or any other units in common service to the life of the nation under the absolute control of the collectivist State. *The only liberty left at the end would be the freedom to serve the community under the rigorous direction of the State authority; the only equality would be an association of all alike in a Spartan or Roman spirit of civic service with perhaps a like status, theoretically equal at least for all functions; the only brotherhood would be the sense of comradeship in devoted dedication to the organised social Self, the State. In fact the democratic trinity, stripped of its godhead, would fade out of existence; the collectivist ideal can very well do without them, for none of them belong to its grain and very substance.*⁸⁷⁶

⁸⁷⁶ Sri Aurobindo, CWSA, 1997, 203-4 (emphasis ours).

In his *Ideal of Human Unity*, Sri Aurobindo considers in some detail this dynamic between competitive individualism in an unregulated free-market arrangement (the concern with the third phase of growth, that of ‘individualization’, in Auroville’s growth trajectory) and a collectivist tendency (strong or weak) geared towards egalitarian regulation and centralized control of resources (the concern with the fourth phase of growth, that of ‘institutionalization’). In Auroville’s context, this debate is recorded, albeit in an incipient way, in the twin (and not mutually exclusive) demands for greater commercial freedom (Thomas and Thomas, Ayer et. al., for example) and an egalitarian distributive ethic, universal ‘prosperity’ along the ‘no-money-exchange’ ideal (Clarence-Smith, for example). Sri Aurobindo records this apparent tension:

The social Reason conceded first the claim to liberty, but in practice (whatever might have been the theory) it admitted only so much equality, equality before the law, a helpful but not too effective political equality of the vote as was necessary to ensure a reasonable freedom for all. Afterwards when the injustices and irrationalities of an unequalised competitive freedom, the enormity of the gulfs it created, became apparent, the social Reason shifted its ground and tried to arrive at a more complete communal justice on the basis of a political, economic, educational and social equality as complete as might be; it has laboured to make a plain level on which all can stand together. Liberty in this change has had to undergo the former fate of equality; for only so much liberty perhaps or for a time could survive as can be safely allowed without the competitive individual getting enough room for his self-assertive growth to upset or endanger the equalitarian basis. But in the end the discovery cannot fail to be made that an artificial equality has also its irrationalities, its contradictions of the collective good, its injustices even and its costly violations of the truth of Nature. Equality like individualistic liberty may turn out to be not a panacea but an obstacle in the way of the best management and control of life by the collective reason and will of the community.⁸⁷⁷

This is also the stress of Mother’s following short remark:

... something that would be an improvement on the Communist system, a more balanced organisation than Sovietism or Communism, that is, which doesn’t too much lean either toward one side or the other.⁸⁷⁸

In this, Sri Aurobindo points suggestively to the way forward (without policy specifications, which is where the rub lies), speaking of what Mother amusingly called the ‘Divine anarchy’:

Equality, social and political equality enforced through a perfect and careful order by a State which is the organised will of the whole community, is the idea on which socialistic democracy stakes its future. If that too fails to make good, the rational and democratic Idea may fall back upon a third form of society founding an essential rather than formal liberty and equality upon fraternal comradeship in a free community, the ideal of intellectual as of spiritual Anarchism.⁸⁷⁹

⁸⁷⁷ Sri Aurobindo, CWSA, 1997, 203.

⁸⁷⁸ Guigan, 2018, Vol. 1, 223.

⁸⁷⁹ Sri Aurobindo, CWSA, 1997, 202.

What is required, therefore, in practice is to develop a legal and institutional architecture within the AVF Act, 1988 that is (i) able to preserve the necessary commercial freedoms and enable / attract the entry of aligned capital and talent, (ii) ensure centralized planning and coordinated action across firms / units for guided investments in infrastructure and research capacity, developing economies of scale, efficient use of resources, (iv) develop an egalitarian distributive ethic, the ‘prosperity ideal’, ‘a happy and beautiful life for all’, without levelling-down, and (iv) which is secured, as far as possible, by a voluntary, uncoerced fraternal culture, ‘the base of the pyramid’. This is simply stated, a long-standing ideal in Auroville as elsewhere, yet difficult to practice and open *inter alia* to free-rider concerns.

It is, however, unlikely to happen in the current setup. The knotty design problem here is as follows: what institutional mechanism allows one to practice the ‘no-ownership’ principle, whilst avoiding the excesses of collectivist management? This philosophical interplay outlined above is well and good, but the problem lies in designing a legal, policy and institutional architecture, supported by a cultural ethic, that can translate its commitments into practice. This is not an easy problem and past actions carry useful learnings – ‘because even errors – even, from a certain point of view, wasteful uses – help in the general progress: they are lessons in reverse.’⁸⁸⁰ Three points may be made here:

First, the current setup is not sustainable in the long-term. Whilst voluntary offering and honest business practices, the dual concern of the Code, are a *sine quo non* for continuing residence in Auroville, these have to be *primarily* generated through inner, individual work supported (and compelled) by the strength of Auroville’s public culture. We discuss the trade-off between rule enforcement, as in the Code, and what Sri Aurobindo calls ‘spiritual compulsion’, the implicit force of the collective culture, in Part IV. Briefly, whilst rule-enforcement is necessary in extreme cases (‘blatant financial mismanagement’, in rule (14-d) of the Code), the self-regulating force of the commercial sector itself must be the primary means to ensure compliance or regulate financially unsound behaviour:

Its [a spiritual society] aim will be to diminish as soon and *as far as possible* [progressively, in lock step with inner development] the need of the element of external compulsion in human life by awakening the inner divine compulsion of the spirit within and all the preliminary means it will use will have that for its aim. In the end it will employ chiefly if not solely the spiritual compulsion which even the spiritual individual can exercise on those around him, — and how much more should a spiritual society be able to do it ...⁸⁸¹

The regulatory emphasis of the Code is understandable but overbearing. One must begin instead with a presumption of goodwill and competence ascribed to commercial units – in general, commercial units have demonstrated high voluntary compliance rates and indeed, supported a steady growth of the Central Fund, alongside contributing where possible to community activities. Whilst the power to intervene, in the extreme through termination of the

⁸⁸⁰ Guigan, 2018, Vol. 1, 274.

⁸⁸¹ Sri Aurobindo, CWSA, 1997, 259 (emphasis and inline comments ours).

residence status, is open to the collective, the heavy compliance burden and oversight processes (approvals, permissions etc.) require consideration.

It is unclear how the growth of the economic sector, which requires talented newcomers and capital infusion, can occur in this regulatory environment. Trust and goodwill are to be developed over time through a cultural and spiritual architecture (particular at sub-zonal levels, where the majority of direct, person-to-person engagement occurs) – whilst this may open to the possibility, indeed inevitability, of non-compliant behaviour or excesses in some cases, these are necessary risks to be undertaken that are preferable to drying up the well.

Second, the AVF Act, 1988 was a historical accident (an unfortunate necessity, as we discuss in Part V) not imagined by the Mother, and does not at least at first glance render an enabling environment for commercial growth. This is so in three ways: first, as we discussed above, it introduced disincentives – to legally ‘donate’ one’s property, labour and surplus to a centrally managed collective, subject to the overriding authority of the Governing Board / FAMC / Working Committee legislated into the 2017 Code, with all regulations subject to amendment by the Central Government. Second, in terms of legal obstacles to borrowing and credit lines through banking channels, necessary to kick-start growth, as Mother too recognized.⁸⁸² The preponderance of residents’ own funds (savings largely, accounting for more than 85% of borrowing) is a concern, particularly if a move away from labour-intensive, small-scale activity is to be undertaken. There have been nascent movements in this direction, with a modest ‘Revolving Loan Fund’ introduced by the ABC in the early 2000s, and currently, Appendix 1 of the 2017 Code provides access to small-scale loans between 1-5 lakhs approved by the Loan Group. Proposals for an ‘Auroville Bank’ in the late 90s to address this concern did not materialize. And third, in terms of external equity participation, through profit-sharing, venture capital or issuing private stock (which can tie in to the proposed ‘Commercial Friend of Auroville’ status). Thomas and Thomas note pointedly:

The main reason for the stagnation of business development is the lack of access to capital and a very low level of banking involvement. Due to the unique structure of Auroville’s business, which are owned by the Auroville Foundation, venture capital cannot easily be attracted. It’s difficult to start joint ventures with outside institutions as the Auroville Foundation cannot hold shares in commercial undertakings without losing its tax-exempt status. Loans can be taken from within Auroville, but only minimally. Loans can hardly be taken from outside as the units cannot offer normal securities and the Auroville Foundation is not prone to risk taking. The non-ownership issue adds to the complexity. The Auroville entrepreneur is beset by two problems: s/he is not working for him /herself, and s/he is working for a higher goal, which nobody outside, particularly bankers, understands.⁸⁸³

⁸⁸² Guigan, 2018, Vol. 1, 111 (‘The Government—Madras has already given us the promise—will give between 60 and 80%: one part grant, that is to say, gift; one part loan, free of interest and repayable over ten years, twenty years, forty years—a long-term repayment. Nava knows all about it, he has already had quite a few results. But according to whether the money comes in quickly or comes in little by little, it will go more or less quickly.’)

⁸⁸³ Auroville Today, January, 2016, 7.

Currently, to the best of our understanding, all units are accounted for under the Auroville Foundation, with liabilities coming on the consolidated balance sheet of the Foundation. As such, a modest risk profile is preferred. This would require *either* substantial loans taken by the Foundation under Section 25 of the AVF Act, 1988 and managed by a professional body for investment in existing or new commercial units, within the current legal architecture, *or* exploring options to allow units to incorporate independently, thus allowing access to capital. We address each of these options in the sections following. In terms of modifications to the current setup, within the 2017 Code of Conduct, the following changes may be considered:

- i. Progressive slabs for contribution in Appendix 2 tied to scale, size, sector and placement in the growth cycle.
- ii. Contributions in Appendix 2 to account for depreciation.
- iii. Examine cost of living concerns for unit executives, with deductions for defined personal / living expenditure under Appendix 2 and raising limit on unit-supported maintenance for executives to attract and retain talent; accordingly amend the framing ‘wholly and necessarily occurred in the commission of the business’ in rule 1, Appendix 2.
- iv. Determine feasibility of ‘specified’ contributions, with credits against the 33% slab.
- v. Power of appointment of unit executives under rule (8) by the Zonal Body (body proposed above / ABC / ABS), instead of FAMC in line with the principle of zonal subsidiarity / devolution.
- vi. Term of appointment under rule (8) by default indefinite, unless otherwise stated, to allow for long-term commitment.
- vii. Define ‘mismanagement’ in rule (8) and ‘blatant financial mismanagement’ in rule (14-d).
- viii. Reconsider unspecified plenary powers ‘in the larger interests of the community’, with specified exceptions (given the plenary power of the Governing Board in any case under the AVF Act, 1988).
- ix. Reconsider unspecified plenary powers in rule (10-b) to undertake ‘any action as required’.
- x. Study format for individualized assessment on request (feasibility / mechanisms will require examination).
- xi. Examine rule (10-b) that requires ‘surplus income’ to be ‘utilized only to further the aims and objectives of Auroville’ to include variable maintenance packages tied to needs / appropriate incentive structures (within limits, given egalitarian /

competitive concerns), permissibility of external donations, defining ‘growth of the unit’ and (subject to examination / definition) reasonable levels of individual support and sustenance, particularly welfare, healthcare, education and housing, as part of the ‘aims and objectives of Auroville’, where not collectively provisioned.

- xii. Reconsider rule (11-b) that allows for ‘forced’ assistance to a unit.
- xiii. Calculation of contribution amounts on current financial year, not previous.
- xiv. Sole powers with FAMC, rather than joint sittings with Working Committee, under rule (12), to streamline processes. Our proposal for resident requested ‘appeals’ / ‘reviews’ to the Unity Committee suggest a framework to address concerns.
- xv. Specify scope of rule (11-c) to include ‘any new activity’ to (Auroville’s equivalent to) the memorandum of association, not to specific activities, to streamline regulatory process.
- xvi. Consider raising debt / other financial liability limits under rule (11-h).
- xvii. Consider raising limit / remove permissions for lease or rent of immovable property not owned by the Foundation above 10 lakhs under rule 11(k).
- xviii. Consider raising limit / remove permissions for capital investments under rule (11-n).
- xix. Offer centralized legal services for units, to ease legal and compliance burden under rule (11-p).
- xx. Consider introducing negotiated exit options for residents who wish to leave to Auroville, as in the 2011 Housing Policy.
- xxi. Operational rationalization of trusts and units, to streamline processes.
- xxii. Complete GST integration; examine feasibility of GST exemption for small units under the legal limit / reorganize trusts accordingly.⁸⁸⁴
- xxiii. Borrowing under the AVF Act, 1988: section 25 of the AVF Act, 1988 permits the ‘the Governing Board ... to borrow on the security of the properties of Auroville or any other asset for carrying out the purposes of this Act’. As far as we are aware, this power has not been exercised. With substantial assets in Auroville, particularly in relation to the outlying lands, Auroville may consider leveraging its assets to secure loans for commercial units, to be administrated by a professional body – the

⁸⁸⁴ See, Auroville Today, Nos. 407-8, June-July, 2023.

Economic Planning Group, in our proposal – for existing and particularly, new enterprises in catalytic sectors.

It bears noting here that the capacity-based / progressive assessment of contributions, rather than a flat slab, was implied by the Mother, though she recognized the practical difficulty in organization along these lines:

This sentence, for instance: ‘All who live there will participate in its life and development...’ ... according to their capacities and means, not a mechanical ‘so much per unit.’ That’s the point. It must be something living and true, not mechanical. And ‘according to their capacities,’ that is, one who has material means such as those a factory gives will have to provide in proportion ...⁸⁸⁵

We may finally note here that suggestions made to contribute the net income / entire surplus / contributions on turnover, rather than 33%, must be weighed carefully. On this point, Mother noted:

They do not seem to know that in Auroville after all expenses are paid, including their own maintenance, the profits go to the town.

... industries will contribute ‘part of their income’.⁸⁸⁶

There will be no taxes as such, but each one will contribute to the collective welfare in work, kind or money.’ So that is clear: there will be no taxes, but each one will have to contribute to the collective welfare by his work, in kind or in money. Those who have nothing but money will give money.

Sections like industries which participate actively will contribute part of their income towards the development of the township; or if they produce something (like foodstuffs) that is useful to the citizens, they will contribute in kind to the township, which is responsible for feeding its citizens.’ This is what we were just saying. The industries will participate actively, they will contribute. If these industries produce articles which are not constantly needed and therefore in amounts or quantities that are too great to be used within the city, but which will sell outside, they, of course, should participate with money. And I give food as an example; those who produce food will give what they produce to the town—in proportion to what they produce, of course—and the town is responsible for feeding everyone. That means that people will not need to buy food with money; but it must be earned.⁸⁸⁷

Three points emerge from Mother’s discussion: first, as we discussed in Part I, the distributive ethic is based on capacity – each is to give according to capacity, in money or in-kind; second, collective provisioning is not ‘free’ but earned, as a fair, reciprocal arrangement of collective solidarity; and third, Mother provides the principled framework for contributions for industrial / commercial units – ‘part of their income’, ‘in proportion to what they produce’, ‘profits’ minus expenditure and ‘their own maintenance’ – but does not provide detailed policy specifications,

⁸⁸⁵ Guigan, 2018, Vol. 1, 223-4.

⁸⁸⁶ Guigan, 2018, Vol. 1,

⁸⁸⁷ Guigan, 2018, Vol. 1, 220-5, 246.

which have to be worked out. Here, Mother's remarks are practical and open-ended, recognizing (we may suppose, implicitly) the need for money for reinvestment, growth and self-sustenance (at reasonable levels). This principle is incorporated in rule (10-c) of the Code, read with Appendix 2, but Mother is agnostic to whether the 'totality of ... net income' should go to the Central Fund or whether it is to be a defined 'part of their income'. In principle, given the ideal of collective offering in karma yoga and the fraternal fabric central to Auroville, all one is 'left with', as it were, after necessary expenditure / investment, on self and unit, is to go the Auroville.

Choices have to be made here: moral and efficiency concerns with centralized allocation of all resources must be balanced with enterprise freedom to invest (in the unit or the community) in their wisdom, given efficient allocations that result from information flows in a liberalized arrangement. In the extreme, this leads to the possibility of unhealthy inequality through unregulated free market exchanges. Mother's principles are agnostic on this long-standing and difficult issue – determining that balance, rather than operating at their extreme, is the challenge that our short suggestions above point to. In principle, resources, money included, must gravitate to those with the 'clearest, most comprehensive and truest vision': this does not immediately translate to centralized allocations or to each unit retaining complete freedom to determine allocations. These are complex questions – particularly at scale, as Auroville grows to larger numbers – that will require careful examination in meaningful conversation with the long-standing literature on the subject. In this, robust data collection on contribution patterns, as also surveys to determine commercial unit and community views, will be necessary for effective and socially sensitive planning. Our proposal below for a dedicated research centre is tied towards anchoring this dialogue.

g. Viability of Incorporating Independent Entities

The changes proposed above to the 2017 Code of Conduct do not address the structural concerns pertaining to the AVF Act, 1988. We offer brief reflections on possible legal, taxation and regulatory forms that may be considered in this direction.

A restructuring along these lines would mean: (i) assets, property and income of the unit would now legally be owned by the incorporated entity, in formal, but not necessarily spiritual, tension with the principle of non-ownership (though majority / minority shareholding of the Foundation may partially resolve this concern), (ii) liabilities would not reflect on the Foundation's balance sheets, thus allowing greater risk, though with the need possibly of a safety net provided by the community for defined circumstances, (iii) the tax exemptions available to the units / Foundation will no longer apply, which will in the short-term adversely affect surplus / contributions. This requires legal, tax and investment options to be professionally evaluated, to identify arrangements for commercial enterprises for operate in Auroville in an enabling environment, whilst sustaining a commitment to the spiritual, not necessarily legal, ideal of non-ownership. In this context, we refer to three opinions solicited by the Foundation from eminent senior advocates Mr. Palkhivala, in 1994, and Mr. Parasaran, in March and May, 2014, concerning the legal and tax viability of independently incorporated

entities.⁸⁸⁸ While a detailed consideration of these matters is beyond the scope of our study, we offer some tentative views.

1. *Taxation Related Considerations*

The Foundation requested a legal opinion from Mr. Palkhivala and Mr. Parasaran on three issues: first, the legal and tax viability of the incorporation of a not-for-profit Section 25 company (under the 1956 Companies Act, now replaced by the 2013 legislation); second, the taxation implications of commercial units organized under trusts registered by the Auroville Foundation, and the implications if they were to be incorporated independently; and third, the legal permissibility of incorporating independent entities, either afresh or by divesting existing assets in the Foundation, given the statutory requirement of ‘general superintendence, direction, control and management’ of the Foundation and Governing Board under Sections 7(1) and 11(3) of the AVF Act, 1988. We tentatively offer alternate readings to suggest that a closer examination of the taxation, legal and strategic implications of floating independent entities may be necessary, as *prima facie* it appears that options to secure the necessary freedoms for commercial enterprises outlined above (access to capital, third party arrangements and operational freedom, with greater risk profile) can be developed in conformity with the AVF Act, 1988.

First, Mr. Parasaran was asked whether the Foundation can incorporate a Section 25 company under the Companies Act, 1956, instead of a trust, to operate as the holding company for commercial enterprises of Auroville. Section 25 has now been replaced by Section 8 of the Companies Act, 2013, which is *in pari materia* with the earlier provision. Mr. Parasaran noted that Section 20(4) of the AVF Act, 1988 permits the Working Committee to set up ‘organizations’ in relation to the work of Auroville, which includes ‘companies.’⁸⁸⁹ However, as a commercial enterprise is a primarily profit-making entity, it cannot be setup as a Section 25 / now Section 8 company meant solely for the purposes of carrying on trade or business or commercial activities.⁸⁹⁰ While activities that are purely charitable in nature as defined under Section 2(15) of the Income Tax Act, 1961, with incidental profit-generation, may be incorporated as Section 8 companies, commercial enterprises would not fall within the definition and thus, be outside the tax exemption net contained in Section 10(23c)(iv) read with Section 2(15). We agree with this opinion. This leaves two options open. The first is to organize all charitable activities – education, health, outreach, environment etc. – as independent trusts or Section 8 companies. The second is to incorporate for-profit, private limited company under Section 3 of the Companies Act, 2013. This second option relates to the second question asked of Mr. Parasaran.

Second, the taxation implication of Auroville’s current system of housing commercial units under trusts incorporated by the Foundation and the proposed system of incorporating legally independent companies or trusts was considered by Mr. Parasaran. He was asked whether a

⁸⁸⁸ Palkhivala, 1993; Parasaran, 2014a; Parasaran, 2014b.

⁸⁸⁹ Parasaran, 2014a, 6-9.

⁸⁹⁰ Parasaran, 2014a, 9-11.

Holding Trust could be established, which will in turn set up trusts, limited liability companies or other organizations. On the taxation implications, point (iii) of the 2007 exemption notification granted to the Foundation by the Chief Commissioner of Income Tax ('CCIT') under Section 10(23c)(iv) of the Income Tax Act, 1961 stipulates that it is conditional: '... this approval shall not apply in relation to any income being profits and gains of business, unless the business was incidental to the attainment of the objectives of the assessee trust ...' On this point, Mr. Parasaran notes that as the overwhelming purpose of the Foundation is charitable, in line with the public works outlined in the Charter, even though some of the activities of the trusts constituted under the Foundation are commercial, they are merely incidental to achieving the main object of the trusts, which is the propagation of the ideals of the Mother in the Charter. As the net income being generated by the commercial units is being 'brought back' to the Foundation and what is 'being retained is only so much as is required for carrying day-to-day activities and to increase productivity and profitability', the income is not taxable as it is within the bounds of the 2007 exemption.⁸⁹¹

Two points emerge in relation to Mr. Parasaran's opinion which may be tentatively considered otherwise: the first is that there is a tension in Mr. Parasaran's opinion – if the profit-generating activity of commercial units under trusts of the Foundation is incidental to their charitable purpose, as they contribute income minus the necessary expenditure for operation and profitability / growth, then *pro tanto*, these entities can be independently incorporated under Section 8 as not-for-profit companies, that generate profit when the defined purpose is to donate them to a charitable institution, the Foundation. The legal form, whether as an independent Section 8 not-for-profit company or a unit under a trust incorporated directly by the Foundation, does not alter the substance of the activity, which is primarily charitable and incidentally, profit-generation. If that is so, then a Section 8 company can be independently incorporated within the exemption net of Section 2(15) read with Section 10(23c)(iv), which provides the added benefit of opening up banking channels.

The second, and more pressing, issue that requires consideration and further study is that the underlying legislation – Section 2(15) of the Income Tax Act, 1961 – was amended in 2015. This materially alters Mr. Parasaran's opinion, given in 2014, such that the tax exemption status of Auroville's commercial units as an independent Section 8 company or within the umbrella of the Foundation, is no longer certain. The *proviso* to Section 2(15) now notes as follows:

Provided that the advancement of any other object of general public utility shall not be a charitable purpose, if it involves the carrying on of any activity in the nature of trade, commerce or business, or any activity of rendering any service in relation to any trade, commerce or business, for a cess or fee or any other consideration, irrespective of the nature of use or application, or retention, of the income from such activity ... (i) such activity is undertaken in the course of actual carrying out of such advancement of any other object of general public utility; and (ii) the aggregate receipts from such activity or activities during the previous year, do not exceed twenty per cent. of the total receipts, of the trust or institution undertaking such activity or activities, of that previous year ...

⁸⁹¹ Parasaran, 2014a, 13-20.

The resulting position on this point was clarified by the Supreme Court in 2022 in *Ahmedabad Urban Development Corporation*.⁸⁹² The Court noted that an entity can be construed to be ‘charitable’, or serving the ‘general public utility’, if three conditions are met: (i) if the activities of trade, commerce, or business are connected to the achievement of its objects of general purpose utility [the promotion of the ideals of the Charter]; (ii) the receipt from such business or commercial activity or service in relation thereto does not exceed the quantified limit, i.e., 20% of total receipts of the previous year, subject to changing regulations; (iii) the charging of any amount towards consideration for such an activity (advancing general public utility) must be on ‘cost-basis’ or ‘nominally above cost’.

Based on this amended definition, it is *prima facie* arguable that Auroville’s commercial units do not fall within the umbrella of Section 2(15). This is so for four reasons. First, the commercial units are, in the legal sense of the term, centrally, not incidentally, profit-generating. That the unit executives donate the ensuing proceeds in a spirit of offering – at present, 33% or the entire surplus, the latter of which was the basis of Mr. Parasaran’s opinion – does not alter the legal nature or character of the activity as profit or surplus generating. The distinction between the nature of the activity and the donative effect is important. Second, the amended definition specifies that the ‘activities of trade, commerce or business’ must be ‘undertaken in the course of *actual carrying out* of such advancement ... *connected* to the achievement of ... general purpose utility ...’ – the actual carrying out of commerce or business by Auroville’s commercial units, i.e., the sale of goods, products and services, is proximate to profit-generation, and not to charitable works, though that may be the deeper motivation and final effect. The promotion of the economic self-sufficiency of Auroville, which Mr. Parasaran rightly notes is an activity in line with and promoting the values of the Charter, per force anticipates, requires and supports profit-generation: as such, profit-generation is not incidental to the charitable activities of the Foundation, but a constituent and explicit feature, as it must be for the Industrial Zone. The spiritual ideal of Mother and Sri Aurobindo discussed above encourages commercial and surplus generating commercial activity, within the limits discussed. Accordingly, the effect of this reading of the Charter on the Section 2(15) / Section 10(23c)(iv) exemption requires further examination. Third, Auroville commercial units charge consideration at more than cost / nominally above cost for external sales (excluding in-kind internal exchanges). Fourth, this also means that, in general and for most units, the receipts from their commercial activity exceeds 20% of the total receipts.

Given this, it is unclear how the legal umbrella of the Foundation, a charitable organization as a whole by way of the 2007 exemption granted by the CCIT, covers the profit-generating units operating within it from tax incidence under the amended Section 2(15). If, as Mr. Parasaran notes, ‘the very purpose of the Section 25 [now 8] company cannot be to solely make profits, *even if* the profits so made are provided to another entity which has been set up for a charitable purpose’,⁸⁹³ this tax incidence cannot be avoided by the indirect route of housing the units / trusts under the legal umbrella of the Foundation if the substance of their activity remains as

⁸⁹² Assistant Commissioner of Income Tax v. Ahmedabad Urban Development Authority, 2022.

⁸⁹³ Parasaran, 2014a, 10.

described, i.e., to generate profits, yet donate them to the Foundation. While units involved in education, outreach, environment and community development and other related works will continue to qualify within the amended Section 2(15) read with Section 10(23c)(iv), the profit-generating units need not. If the units donate the surplus, whether the entirety or 33%, that will rightly entitle them to claim deductions from the gross total income under Section 80G, under which the Foundation is also notified as a charitable institution. The deduction is proper, but the claim to an exemption may require a closer examination for the reasons outlined above. From a tax angle, the same situation obtains whether units operate within trusts, private limited company or partnerships incorporated by the Foundation or if a formally independent corporate entity is established. In our reading of Section 20(4) of the AVF Act, 1988, both routes are permissible. This was the next question considered in the opinions.

Third, Mr. Parasaran and Mr. Palkhivala were asked to examine the legal permissibility of incorporating entities formally independent of the Foundation, of which it is not the exclusive owner. Both Mr. Palkhivala and Mr. Parasaran answered in the negative. This related, in their analysis, to the need for ‘reliability’ to the Foundation, and in particular, the twin conditions under Section 20(4) of the AVF Act, 1988 – to be housed in Auroville and to conform to the general superintendence, control and direction of the Governing Board / promote the ideals of Auroville.⁸⁹⁴ Mr. Palkhivala noted that Section 20(4), which permits the Working Committee of the Residents’ Assembly to establish organizations with the approval of the Governing Board, does not permit ‘a complete parting with the entire ownership of property.’⁸⁹⁵ He suggests a ‘cautious approach’, which the Foundation may consider ‘entrusting the enforcement of the property to a third party and keeping the ownership with the Foundation’.⁸⁹⁶ Mr. Parasaran similarly notes that Section 11 mandates that ‘superintendence, control and management’ of any independent entity – whether a trust, limited liability partnership or not-for-profit company – must lie exclusively with the Governing Board and that it must be housed in Auroville under Section 20(4).⁸⁹⁷

In relation to a proposal to create a special purpose vehicle to enter into a private equity and profit-sharing partnership with an external non-Auroville entity to develop projects on outlying lands that offer a helpful revenue stream, Mr. Parasaran advised against this move for two reasons. The first was the tax implication, as the explicit profit motive would not be covered under the 2007 exemption. The second was a legal concern. Mr. Parasaran noted that the assets and undertakings of Auroville, including those of the units, vest exclusively with the Foundation – they may thus be used to generate ‘maximum possible’ income by the Foundation itself by an exclusively held trust, but not with an external entity in a third-party project-sharing arrangement ‘at this juncture’ as that would dilute the Foundation’s interest.⁸⁹⁸ The legal

⁸⁹⁴ Palkhivala, 1993, 1; Parasaran, 2014a, 12-13.

⁸⁹⁵ Palkhivala, 1993, 1.

⁸⁹⁶ Palkhivala, 1993, 1.

⁸⁹⁷ Parasaran, 2014b, 5.

⁸⁹⁸ Parasaran, 2014b, 10-12.

requirement was to ensure that the ‘right, title and interest ... vests *only* with the Querist [the Foundation]’.⁸⁹⁹

The alternate construction proposed may need to be explored today, as Auroville is at a different juncture and the commercial necessity presents compelling circumstances. Two issues arise, a legal one and a strategic / regulatory one.

2. *Considerations under the AVF Act, 1988*

On the legal issue, all properties, assets and associated interests vest in the Foundation, with the ‘general superintendence, direction, control and management’ of the Governing Board, subject to our comments on the relationship between the Governing Board and Residents’ Assembly in Part V. Importantly, as we discuss there, Mother had noted that ‘to hand over the management of Auroville to any country or any group however big it may be is an *absolute impossibility*.’⁹⁰⁰ Thus, for the plan area, such a ‘handing over’ would be both contrary to Mother’s words and the spirit of the AVF Act, 1988, aside from strategic reasons that militate against a breaking up of the lands. However, as we discuss below, for the non-priority outlying lands, purchased when Auroville’s precise location was not yet decided, leveraging their economic potential through equity or profit-sharing arrangements may be financially necessary. The text of the AVF Act, 1988 locates issues in this context. The requirement of Section 20(4) that the ‘organization’ – whether a trust, partnership or private limited company – be based in Auroville and that it is subject to the general superintendence of the Governing Board / working towards the ideals of the Charter. Sections 7 and 11 in turn define the powers of general superintendence of the Governing Board in this respect, with a mutual interdependence and delineation of equal powers with the Residents’ Assembly in Sections 18 and 19. As such, the text of the AVF Act, 1988 is clear: the Working Committee of the Residents’ Assembly (appointed and answerable to it) and the Governing Board must both independently agree for Section 20(4) to be activated. This is part of the mutuality and system of checks and balances codified by Professor Joshi, the drafter of the AVF Act, 1988. We discuss this in Part V.

What this translates to in this context is the following: there is no legal hurdle to the Working Committee (with the approval of the Governing Board) establishing a partnership, private limited company or trust to hold outlying properties. These are not part of the physical base of Auroville. Administrative practice in the past supports this reading, as these lands have been exchanged for lands within the plan area. The plenary powers of the Foundation in Section 7 – as distributed between the Governing Board, Residents’ Assembly and the Working Committee – do not, either in text or spirit, disallow the optimal utilization, exchange or if deemed necessary, after transparent processes and scrutiny, sale of these lands so long as this is done ‘with a view to making long-term arrangements for the better management and further development of Auroville’.

⁸⁹⁹ Parasaran, 2014b, 10-12 (emphasis ours).

⁹⁰⁰ Guigan, 2018, Vol. 2, 66-7 (emphasis in the original).

Evidently, the effective utilization of the outlying lands requires at this time, as in 2014, external capital and expertise to develop. Sections 7 transfers ‘the right, title and interest’ for the ‘management of the affairs of the undertakings’, of the Sri Aurobindo Society which vested in the Foundation in 1988 and have since grown due to independent actions of residents. This power of plenary ‘management’ includes the power to alienate (by sale) or dilute (by partnership), if necessary to meet the long-term development of Auroville. As we discuss in Part V, canons of legal interpretation require that the literal meaning of the text, if unambiguous, dictate the construction of the statute. As such, there is no explicit or implicit restriction of plenary powers of the Foundation in relation to the sale, exchange, lease etc. of lands, properties and assets (including outlying lands) in Section 7 (as opposed the powers of the Governing Board under Section 11, which are self-limiting in relationship to the co-equal Residents’ Assembly, discussed in Part V). As long as the underlying purpose of the legal incidence of sale, exchange, lease, profit-sharing agreement etc. coheres with the long-term interests of Auroville, there appears to be no legal impediment. Plenary powers are by default permissive, i.e. permitting all actions necessary for the objective for which the body was created absent specific proscriptions.

Though precise correspondence with the AVF Act, 1988 is not to be found, precedent lends support to the position that the holding of property by a public authority in trust – held here by the Foundation in Divine trust or responsible stewardship, or as Mr. Sorabjee notes in trust for the ultimate beneficiaries, the residents – includes the right to use, encumber or alienate subject to the demonstration of public good so defined. For example, Sections 23 and 34 of the Tamil Nadu Hindu Religious and Charitable Endowments Act, 1959 and Sections 51 of the Wakf Act, 1995 both demonstrate that properties held in public trust imply, without further specification, the right to use, alienate or otherwise modify, subject only to demonstrated public benefit in the context of that particular statute and social setting.⁹⁰¹

Similarly, the requirement of Section 20(4)(a) may be met by having the headquarters of the joint-enterprise / SPV in Auroville as an explicit requirement under the Memorandum or Articles of Association / Trust Deed / Partnership Agreement etc. (which can be negotiated with the partner organization) and that of Section 20(4)(b) may be met by a majority shareholding for the Foundation (to be delegated to the Economic Planning Group), such that it may act ‘in conformity with the decisions of the Governing Board.’ As Mr. Parasaran notes, such a profit-making enterprise will fall outside the net of 2007 exemption / Section 10(23c)(iv) read with Section 2(15). That, however, is a necessary trade-off to develop the lands and generate revenue – the net revenue will naturally exceed the current under-utilization of the lands. As long as these entities (joint enterprise / SPV) are independently incorporated, with majority shareholding for the Foundation, represented by its nominees in line with internal practices of the FAMC / proposed Economic Planning Group, the tax incidence will fall on the entity, without jeopardizing that of the Foundation under its 2007 exemption. Thus, for legal,

⁹⁰¹ See, Rangarajan Narasimhan v. State of Tamil Nadu and Ors., 2021, para. 6; Sabir Ali Khan v. Syed Mohd. and Ors., 2023, para 30.

financial and prudential / strategic reasons, such a partnership model for outlying lands is both viable and necessary.

Insofar as the independent incorporation of legal entities for other commercial units is concerned, the financial reasons – to open credit lines, allow for operational freedom and a greater risk profile consistent with the entrepreneurial needs of Auroville – have been outlined above. The legal, tax and strategic / regulatory impediments are equally *prima facie* resolvable. The legal impediment is as follows: in Mr. Parasaran’s view, no Auroville entity can be owned exclusively by any entity other than the Foundation, either in terms of existing assets vested in the Foundation that may need to be divested to that independent entity, or in terms of new assets sought to be created. As in the discussion above on outlying lands, there appears to be no *a priori* legal impediment in Sections 7 and 11, which confer plenary powers of management, including powers to use, lease, leverage, sell etc. If transparently proven to be ‘long-term arrangements for the better management and further development of Auroville’. This applies in principle both to existing undertakings (assets of ongoing commercial units) or those to be created in the future. The requirement that exclusive control vest with the Foundation, does not *prima facie* emerge from the text or the spirit of the AVF Act, 1988. The text grants plenary, unfettered powers in this respect, subject only to the general constraints of trusteeship, reasonableness and transparency. In terms of the spirit of the legislation, we may note that in the early years, Mother anticipated joint developments with the Government of Madras, private industry and even loans taken as against the land on which Matrimandir now stands, indicating, though not conclusively determining, that such arrangements can be permitted within defined bounds under the legislative scheme. That said, it is clear that the lands in the plan area should not be sold, permanently leased or otherwise alienated emerges because this action cannot, by definition, be for the ‘long term ... better management’ of Auroville.

Thus, in our reading, there is no legal impediment to incorporating independent entities, which may hold assets, properties etc. other than the lands of Auroville or other key infrastructure. Naturally, these entities must be headquartered in Auroville as part of their constitutional documents (the Memorandum and Articles of Association), which must also include a commitment to abiding by the directions of the Governing Board, subject to the regulatory question below. Next, from the taxation perspective, as in the case of SPVs for out-lying lands, these commercial units – if established as partnerships, trusts or for-profit / not-for-profit private limited companies – will be subject to income tax, if our reading of the 2015 amendment to Section 2(15) of the Income Tax Act, 1961 offered above is correct. Section 80G deductions and other tax benefits, may be claimed for donations to the Central Fund / Auroville Foundation. This will naturally affect the contributions to Auroville’s Central Fund, yet the financial advantages – of opening up credit lines, allowing greater risk profiles, inviting entrepreneurs as newcomers within a liberalized regime – will, all else being equal, generate greater revenues, stronger capital formation and intensity in the mid to long-term.⁹⁰² This, at

⁹⁰² As a broader matter, we may note here, perhaps as an unpopular point, that commercial units in Auroville should operate on par with commercial units elsewhere which donate substantial portions of their profits to

any rate, is a decision that can be taken based on the merits of each proposal for independent incorporation, as some entities (particularly smaller ones) may benefit from the legal umbrella of the Foundation. It is a strategic decision for the FAMC / proposed Economic Planning Group to consider on a case-by-case basis, not an *ab initio* concern that renders independent incorporation legally impermissible.

3. Regulatory Considerations

The third and strategic or regulatory concern is perhaps the most challenging. On one hand, there is a worry that one may go down slippery slope, if independent entities are allowed to be incorporated as it may lead to a dissipation of energies from the Central Fund / the Auroville collective, with residents operating ‘independently’ of Auroville. On the other, if these entities are to be headquartered in Auroville, the lands on which they operate will not belong to them, though movable and other assets will, which may raise concerns over the distribution of legal rights and duties. What this requires is a careful and sensitive regulatory design to ensure that financial benefits of independent incorporation can be balanced with the imperative of collective involvement of the companies / trusts / partnerships, as the case may be in Auroville. We may make four brief suggestions here that may be explored if this option is considered viable.

First, the incorporation of independent entities is not a matter of right for each resident, in the scheme suggested above. Residents may make proposals to demonstrate the need and necessity of such independent corporate forms, with economic benefits, regulatory oversight and balance, prior record, integrity etc., to allow for a holistic, case-by-case analysis by the FAMC / proposed Economic Planning Group. There is thus no necessary danger of dissipation of energies in a raft of independently incorporated entities.

Second, the constitutional documents of each entity must indicate, in appropriate, standard language that may be drafted, that their headquarters will be based in Auroville, that their main object is to promote the ideals of Auroville and that they will abide by all decisions of the Governing Board.

Third, to balance concerns of regulatory oversight by the Foundation and commercial freedom, we may suggest two potential structures for consideration, as rough templates for further refinement and elaboration. One option is to institute a majority shareholding for the Foundation, with an appropriate shareholders agreement to define a regulatory mechanism by which that shareholding will be exercised sparingly to allow for commercial / enterprise freedom of the residents leading the unit, with defined grounds and secure processes for when interventions (including removal of residents from the commercial entity) can be made by the Economic Planning Group, with a review lying with the Unity Committee and finally, Steering

charitable purposes yet do not benefit from exemptions under Section 10(23c)(iv) – as a ‘representative’ and ‘model city’, particularly one that benefits substantially from Government grants (Rs. 113.51 crores between 2011-23), Auroville may consider the incidence of income tax on its commercial units, to contribute back to the common pool, with the benefit of deductions and other exemptions as may be available for donations made to the Foundation.

Group in our proposed scheme. This will allow for effective checks and balances that can secure trust in the enterprise of a fair process if excesses do occur in some instances on either side. Locating this power in the Residents' Assembly, as some suggested, would be a cumbersome administrative process, and in the Governing Board, may not be practical given the imperatives of full-time work of the members, which limits day-to-day oversight. Moreover, the necessary commercial expertise to address these matters will be best represented in the Working Groups identified along the principle of illumined hierarchies, as we propose in our reform for Working Group selection, operation and accountability in Part IV.C. The second, stronger, option is to allow for minority shareholding for the Foundation, allowing even greater enterprise freedom as may be demanded in some cases, particularly with external equity participation in joint innovation / manufacturing projects at scale (that Auroville is yet to undertake). The entities will still have to make legal declarations under Section 20(4) as identified above, yet absent a majority shareholding, the power to remove or otherwise alter the operation of the entity when deemed necessary under defined circumstances, will naturally not be available. As we note below, a level of trust is assumed in this organizational form, and as such, it may be permitted to begin only if there are good reasons to indicate that fact. However, in the extreme, the exclusive power of the Residents' Assembly to terminate residence-status under Section 19(2)(a) remains as a last resort. We may note that in either configuration (or others that may be designed on a more thorough and careful study, with professional advice), further detailing will be necessary – for example, as to lease or other arrangements for the land on which the enterprise operates in Auroville, to ensure clarity on nature and extent of land use and utilization and exit options for enterprises / residents who choose to leave Auroville and wish to move personally, or with their enterprise, elsewhere. Defining appropriate and fair exit options, as indicated in the Housing Policy of 2011 (though not defined in practice) is an important requirement, to generate trust and reciprocity that may invite newcomers and capital.

In sum, the independent incorporation of corporate entities – which are helpful for the growth of the commercial sector, yet to be sensitively regulated given dangers of dispersion – offers a promising route for a balanced, yet vigorous commercial actions for the units in Auroville and those on the outlying lands. Our analysis above is tentative, yet the legal, taxation and regulatory options are worth examining in greater detail. If undertaken, this will likely require enabling regulation of the Governing Board under Section 32(1), with the approval of the Central Government under Section 32(3).

We may note here an important concern voiced by many pertaining to insufficient regulatory oversight leading to dangers of moneys and energies leaving the Auroville collective or breaking up the unified umbrella of the Foundation. Whilst it appears that appropriate and smart regulatory design thinking can mitigate these fears, ultimately, as Mother noted and we consider in Part IV.D, it is the inner architecture, supported by a strong cultural ethic of 'spiritual compulsion', that will generate 'compliance' with the ideal of non-ownership and voluntary contribution to the Divine, in the frame of the Auroville community. Coercive rule-enforcement is at times necessary and an option kept open in the kind of structuring proposed

above; that said, particularly in Auroville's unique context, it is best avoided and hopefully transcended.

Given the required porosity between Auroville's commercial sector and the market, for economic reasons as much as spiritual ones (to sustain an open, vigorous, innovation-led tertiary knowledge economy), there are strong reasons for Auroville to consider liberalizing its economic mould. This will require a reconsideration of the Code of Conduct, 2017 in the current setup and if further reforms are instituted, of the current regulatory architecture under the AVF Act, 1988. The feasibility of these options will require further examination with the aid of professional advice to evaluate corporate forms and internal Auroville regulations that can balance the twin concerns – appropriate guardrails for accountability, such as majority shareholding, with appropriate shareholders agreements, nominees on the Board of the incorporated entity, action in case of defined mismanagement, residence-status linked to financial integrity etc., with defined regulations for lease of Auroville lands on which enterprises are setup, fair exit options in case of closure etc.

h. Establishing an Economic and Social Policy Research Centre

Anchoring these strategic changes to grow the Industrial Zone in line with Auroville's ideal is a complex matter, for which a *sui generis* model will have to be developed, in robust exchange with the literature and 'external', aligned experts. This is a field that requires professional expertise – a dedicated research framework for economic and social policy is thus necessary, both as a matter of practical policy specifications and as importantly and excitingly, as a matter of knowledge-generation, to anchor the work of the proposed body / FAMC / BCC for the next stage of Auroville's economic growth.

As we noted above, Mother's guidelines were often cast at an abstract level, which require further work to detail out policy prescriptions. For example, in 1954, speaking of the ideal city, Mother noted that she shall not give a 'long description' of the organisation and the working of the institution, although everything in it to the 'smallest details' has already been foreseen.⁹⁰³ However, as the work of detailing out the smallest details began later with Auroville, she noted:

So then, there slowly, slowly comes the possibility of putting it into practice.⁹⁰⁴

The difficulty is the appreciation of the value of things. You understand, that requires a very wide vision. Money's convenience was that it became mechanical.... But this new system cannot become quite mechanical, so ... For instance, the idea is that those who will live in Auroville will have no money – there is no circulation of money – but to eat, for instance, everyone has the right to eat, naturally, but ... On quite a practical level, we had conceived the possibility of all types of food according to everyone's tastes or needs and those who want to get food from there must do

⁹⁰³ Guigan, 2018, Vol. 1, 49.

⁹⁰⁴ Guigan, 2018, Vol. 1, 274.

something in exchange – work, or ... It's hard to organize in practice, on a quite practical level....

So ... Now I have to face the whole problem in every detail, and it's not easy! There are some who understand. You see, the idea is that there will be no customs in Auroville and no taxes, and Aurovilians will have no personal property. Like that on paper, it's very fine, but when it comes to doing it in practice ...⁹⁰⁵

There are many questions for Auroville to resolve in practice. These include: its commercial profile across branches, capitalization concerns, building catalyst areas in the knowledge-economy, strategic investments for future innovation-led entrepreneurial growth, incubating start-ups, identifying appropriate market links, legal / institutional arrangements to allow for enterprise freedom and access to capital and credit, developing at-scale individuated assessments for needs-based assessment in line with the 'prosperity ideal', clarifying the 'no-money-exchange' ideal, developing appropriate contribution scales and mechanisms etc. Answers to these issues – some of which have been discussed in the community since 1968 with Pour Tous, and some which have not figured as prominently – can benefit from a dedicated research framework, guided by an 'illuminated (financial) hierarchy'.

The Social Science Research Centre, which anchored the work of Thomas and Thomas, with Sampathkumar's instrumental role, provides the foundations for this setup. In this, the proposed Centre may, *inter alia*, consider the following works:

- i. Institute research fellowships / exchanges with leading, aligned universities;
- ii. Explore a peer-reviewed journal to anchor research in Auroville. In time, this Centre may relate to the 'embedded free-progress university' proposed in Part III.D; consider a yearly research conclave to generate research output and invite leading practitioners globally.
- iii. Access competitive grants for research in and about Auroville.
- iv. Work with SAIER to develop curricula for school-based incubators / curricula in economic and social policy particularly for high-school students.
- v. Develop financial literacy programmes for residents and the bio-region to develop greater understanding of Auroville's economic ideals and anchor discussion in specific policy challenges rather than vaguely articulated goals.
- vi. Work with the proposed body / FAMC / BCC to digitize / automate regular collection of financial data of units and employees, to strengthen data management. We propose a city-wide Data and Statistics Office in Part IV along these lines, which may overlap with this suggestion.
- vii. Study the future of work / appropriate economic profile for planned population increases, to inform outreach and entry processes.

⁹⁰⁵ Guigan, 2018, Vol. 2, 86-7.

4. *Budgeting Solutions*

A review of the budgeting process, including changes brought about in 2020 for participatory budgeting, are beyond our scope.⁹⁰⁶ In general, a professionalization of the budgeting process seems necessary to move away from spreadsheets, for efficient, transparent and data-driven asset allocation, forecasting / analysis, monitoring and review. This can among other things enhance the participatory budgeting process through easy access public reporting. The introduction of local government budgeting, planning and monitoring software solutions, integrated with an ERP for performance analysis, now widely used will be useful.

i. Leveraging Professional Consultancy Services

As we discussed above, Auroville has begun, in no insignificant manner, to leverage its knowledge-capital base in key sectors, ecology, architecture / sustainable building, energy and to a limited extent, education to develop professional consulting services. These accounted in 2019-20 to approximately 20% of contributions to the Central Fund. The expertise developed in key areas over long years now places Auroville well to position itself as a major player, (i) leveraging significant economic opportunities, (ii) whilst as importantly, assisting and supporting aligned initiatives elsewhere given the pressing need for professional services in these sectors, and (iii) developing its profile as a centre for learning and innovation. Auroville Earth Institute, Auroville Design Consultants, Auroville Consulting, PATH, Pitchandikulam, and others have generated strong movement in this direction. The educational sector, as we discussed in Part III.D, has yet to harness this capacity. These may be assisted by strategic offerings of integrated professional services with consulting firms across sectors, engineering, information technology, technology services in computing, software development, web development, UX/UI, cloud services etc., accounting, enterprise management, investment management, etc., whilst leveraging existing capacity and expertise in construction management, architecture / design, urban planning, ethical marketing / sales, alternate medical therapy, education, including ed-tech etc.

j. Food Production and Processing

As we noted above, food production and secondary processing activities have played a limited role in Auroville's commercial profile. This is naturally understandable, as the priority for these sectors has historically been to ensure the ecological security of the region and in terms of production, to develop largely small-scale, research and experiment oriented organic farming

⁹⁰⁶ There have been criticisms of the process. *See*, Auroville Today, December, 2019, 43 ('The BCC's functioning, said the FAMC, had left something to be desired. The BCC had not been able to produce regular and timely annual budgets based on good knowledge of ground realities; it did not take timely decisions; there was little or no monitoring of activities; and it was irregular in its reporting to the community, aside from publishing monthly figures. 'I have been an FAMC member for two years,' said Dhruv. "The first budget submitted by the BCC was delayed for more than six months. In the absence of a budget, the FAMC was forced to approve only an inflationary increase of a flat 4% for each City Service budget. The capacity to drive the financial coordination was missing.')

techniques, sufficient for Auroville's own nutritional self-sustenance. We discuss these in Part III.F. However, surplus / export-oriented production and processing options are not insubstantial and can be explored, within market niches for organic and health foods under an Auroville marker. These may also include aquaculture and 'forest food' options that can be explored. Advancing this strategy will require the development of common processing units for value add and strategic market development. Revi's short comments in 2007 are relevant today:

There appear to be a large set of challenges to higher value addition in the primary sector with issues around food security, underleveraged biomass assets and water constraints. Nevertheless, Auroville's significant biomass stock and considerable biodiversity and medicinal conservation experience should provide additional opportunities for value addition via initiatives in areas such as green-power, medicinal extraction and health foods.⁹⁰⁷

We are given to understand that work along these lines was being considered as of May, 2023.

k. Tourism Sector Revenues

Auroville has a significant tourist footfall, with more than 7 lakh visitors as of 2017 and 5.4% of City Services Contributions in 2019-20 coming from guest houses.⁹⁰⁸ The 2019 Tourism Impact Management Framework Study, the only in-depth analysis on the subject as far we are aware, conducted as part of a Queen's University Exchange in collaboration with the Auroville Integral Sustainability Institute, noted:

... domestic tourism in India is increasing due to the rise of the middle class, which is anticipated to contribute to continuously increasing levels of tourism. In terms of the economy, the team heard that there is funding available for various programs and projects in relation to tourism, but generally, Auroville is unsure of the extent to which casual visitors contribute to the community's economy. This lack of understanding surrounding the effect of tourism on the economy has not deterred tourism related development providing employment opportunities for residents of both Auroville and Edayanchavadi. Therefore, there has been a shift in Edayanchavadi's economic base from agriculture to tourism ... The current capacity of tourism infrastructure is unknown in Auroville, with a lack of data being present on the issue.⁹⁰⁹

Similarly, Ayer et. al.'s 2019 study noted:

The population [of tourists] varies between couple of thousands a day to over ten thousand during holidays and special occasions, placing a demand on essential urban services like roads, public parking, water, energy, sanitation, solid waste management

⁹⁰⁷ Revi, 2007, 7.

⁹⁰⁸ Tourism Impact Management Framework for Auroville, 2019, iii; Auroville City Services Report, 2021-22.

⁹⁰⁹ Tourism Impact Management Framework for Auroville, 2019, iv.

and human resources to order and facilitate the flow. They are also a source of revenue through parking fees, food & beverage and sale of products.

...

With the growth in Auroville resident population there will be proportional increases in the population ... volunteers, visitors and tourists who will contribute and [provide] benefits ... to Auroville's economic development ⁹¹⁰

There are naturally environmental, resource and cultural effects to large-scale tourism in Auroville, which have to be urgently and consciously regulated. It is important to underscore that Auroville is not a 'tourist destination', though it is telling that the only functional linkage with Auroville identified in the Comprehensive Development Plan for Puducherry Planning Area, 2036, approved in 2019, and the 2007 Villupuram Development Report prepared by the Tamil Nadu State Planning Commission is in relation to tourism.⁹¹¹ This concern was recognized first in the 2005 Mobility Plan to regulate tourist inflows to the four zones by permission, thus avoiding an unchecked influx. Along these lines, the 2017 TDC Terms of Reference notes:

In the residential zone will be restricted to use by residents and registered guests of Auroville. In the cultural zone will be restricted to use by residents and registered guests of Auroville. In the Industrial Zone, activities will be only 'B2B' activities except for areas identified and agreed upon as exceptions in the detailed development plan ... tourists and visitors to be seen as a gift and adequate measures and facilities set up to manage well, the influx and mobility of visitors.⁹¹²

No tourism management framework – either to control the flow of tourists, generate meaningful tourism patterns or evaluate revenue-generation strategies – is yet in place. If appropriately managed, both materially and in terms of messaging, this can both be an important revenue source and allow for meaningful contact with the world. Again, Revi's short remark in 2006, is relevant today:

Green and experiential 'tourism' could be an important driver of Auroville's economy. If well managed it could also meet the larger goals of educating people in the region and the world about the process of evolutionary transformation that Auroville is experimenting with. However, the risks in terms of resource intensity, environmental impact (including on the subtle environment) are also significant and would have to be handled with caution. Capacity to be able to engage with and develop this as entrepreneurial areas, would need to be enabled in the community.⁹¹³

⁹¹⁰ Ayer et. al., 2019, 3, 28.

⁹¹¹ Puducherry Planning Authority, 2019, 15; Villupuram Development Report, 2007.

⁹¹² TDC Terms of Reference, 2.1.1.

⁹¹³ Revi, 2007, 8. Existing tourist packages like the Forest Walks/Tours (Sadhana Forest tour etc.) are a case in point.

To this end, the following actions may be considered:⁹¹⁴

- i. Develop the offerings of the Auroville Campus Initiative / University for allow for learning-related tourism, with dedicated living / housing establishments for visiting learners in the Cultural and International Zones, offset by revenues.
- ii. Auroville and bio-regional mobility planning to address traffic and congestion concerns, as also to stem the promotion of Auroville as a tourist destination, as discussed in Part III.A. This will require a concerted push to strengthen regional planning ties with Pondicherry and the Tamil Nadu Government to dissuade them from promoting Auroville as a tourist destination.⁹¹⁵
- iii. Environmental, resource and personnel audit to understand the carrying capacity for inflows and personnel requirements for effective management, including programming to facilitate knowledge sharing with day visitors.
- iv. Improve collaboration with Edayanchavadi and other Green Belt villages in regard to tourism related development, through the Village Development Councils / TDC Village Interface team discussed in Part III.A.
- v. Data collection practices for tourism in Auroville and the bio-region, particularly Pondicherry, for evidence-led planning.
- vi. Centralize guest house booking and payment facilities.

l. Leveraging Outlying Lands

We have discussed the legal, taxation and regulatory concerns in the handling of outlying lands. As of now, Auroville has approximately 1,100 acres of land secured in the early years, particularly around Auromodèle. Aside from the question of exchanges / sales to secure the remaining lands in the plan area, the following options may be considered, subject to our discussion above:

- i. Sale of high value parcels to generate capital for investment, on the principle that securing the 'city' is, *ceteris paribus*, priority over 'buffer' lands. The economic situation today demands the availing of all possible options.
- ii. Rental / profit-sharing real-estate development agreements (of the kind signalled in Mr. Parasaran's March 2014 opinion) to ensure harmonious land use and generate income.
- iii. Examine feasibility of land banking and transferable development rights.

⁹¹⁴ We incorporate important suggestions of the Tourism Management Framework for Auroville, 2019 and the IDPP, 2014 here, which discuss this issue in greater detail.

⁹¹⁵ See, Tourism Management Framework for Auroville, 2019, 76. This is a key point.

- iv. Institute public-private partnerships / external equity participation to develop manufacturing and other commercial services on suitable lands identified by the LRD Task Force.

m. Regional Economic Integration

As we discussed in Part II, Auroville is yet to explore economic linkages with Pondicherry, Cuddalore and Viluppuram district in terms of food production or manufacturing. The Masterplan noted proximity to these urban centres, including Tinidvanam, with whose development 'Auroville's development is closely linked.'⁹¹⁶ Given a radical land use change from agriculture to other sectors in this region, as also employment needs, a linked framework to develop economic activities in mutually-supporting specializations in each centre urban can stem labour migration and build common infrastructure at scale. As of 2012, Cuddalore's economy revolved around the activities of 30 industries in SIPCOT, an industrial estate on the outskirts of the town on the Cuddalore-Chidambaram road; Pondicherry has been migrating from a largely agricultural profile to manufacturing industries, with a 200% increase in the number of industrial units from 1990-91 to 2005. The Confederation of Indian Industries' Puducherry Vision 2025, and a series of government initiatives to attract non-pollution industries, indicate movement for the future. It is therefore in the interest of both Auroville and the region's economy to engage with Pondicherry and Cuddalore to generate a common economic action plan. Any viable long-term future must generate sufficiently strong links, economically and otherwise, with neighbours.

n. Self-Interest, Solidarity and Motivations to Commercial Work

Community dialogue in Auroville has repeatedly emphasized the question of 'money infiltration' and greed that accompanies commercial activity. A fuller survey would be required to understand the 'value economy', as it were, on this question in Auroville. Yet, records seem to indicate an aversion to the motives of profit-generation common to commercial activity, which seem to stand in tension with the spiritual ideal, in particular the 'no-money-exchange' principle. Some interviewees suggested that this partly explains the under-development of the commercial sector. Insofar as this is the case, we offer some short reflections, with a rough sketch of Mother and Sri Aurobindo's views as they tie in to debates in Auroville.

In placing the Industrial Zone as one of four constituent pillars of Auroville, Mother envisioned a culture of sufficient and appropriate production to develop a 'modern' city. Her design indeed relates to the four-fold Vedic image of 'Divine as knowledge in man, the Divine as power, the Divine as production, enjoyment and mutuality, the Divine as service, obedience and work.'⁹¹⁷ The question, in both Mother and Sri Aurobindo's writings, is on the nature and placement of production to the broader ends of life, the use and limits of commerce. In this, they were distrustful neither of capital or labour, nor indeed reactive, as many thinkers of their time, to

⁹¹⁶ Masterplan, 2001, paras. 1.3.3-4.

⁹¹⁷ Sri Aurobindo, CWSA, 1997, Vol. 25, 10.

industrial expansion.⁹¹⁸ Their concern rather was with what Sri Aurobindo called the 'economic barbarism' that had characterized the mid-1900s, an extreme and vulgar revaluation of the true end of life as production, accumulation and vital satisfaction. We quote his rather striking commentary, recording the sociology of this Faustian bargain, in full:

This economic barbarism is essentially that of the vital man who mistakes the vital being for the self and accepts its satisfaction as the first aim of life. The characteristic of Life is desire and the instinct of possession. Just as the physical barbarian makes the excellence of the body and the development of physical force, health and prowess his standard and aim, so the vitalistic or economic barbarian makes the satisfaction of wants and desires and the accumulation of possessions his standard and aim. His ideal man is not the cultured or noble or thoughtful or moral or religious, but the successful man. To arrive, to succeed, to produce, to accumulate, to possess is his existence. The accumulation of wealth and more wealth, the adding of possessions to possessions, opulence, show, pleasure, a cumbrous inartistic luxury, a plethora of conveniences, life devoid of beauty and nobility, religion vulgarised or coldly formalised, politics and government turned into a trade and profession, enjoyment itself made a business, this is commercialism. To the natural unredeemed economic man beauty is a thing otiose or a nuisance, art and poetry a frivolity or an ostentation and a means of advertisement. His idea of civilisation is comfort, his idea of morals social respectability, his idea of politics the encouragement of industry, the opening of markets, exploitation and trade following the flag, his idea of religion at best a pietistic formalism or the satisfaction of certain vitalistic emotions. He values education for its utility in fitting a man for success in a competitive or, it may be, a socialised industrial existence, science for the useful inventions and knowledge, the comforts, conveniences, machinery of production with which it arms him, its power for organisation, regulation, stimulus to production. The opulent plutocrat and the successful mammoth capitalist and organiser of industry are the supermen of the commercial age and the true, if often occult rulers of its society.

The essential barbarism of all this is its pursuit of vital success, satisfaction, productiveness, accumulation, possession, enjoyment, comfort, convenience for their own sake. The vital part of the being is an element in the integral human existence as much as the physical part; it has its place but must not exceed its place. A full and well-appointed life is desirable for man living in society, but on condition that it is also a true and beautiful life. Neither the life nor the body exist for their own sake, but as vehicle and instrument of a good higher than their own. They must be subordinated to the superior needs of the mental being, chastened and purified by a greater law of truth, good and beauty before they can take their proper place in the integrality of human perfection. Therefore in a commercial age with its ideal, vulgar and barbarous, of success, vitalistic satisfaction, productiveness and possession the soul of man may linger a while for certain gains and experiences, but cannot permanently rest. If it persisted too long, Life would become clogged and perish of

⁹¹⁸ Responding to 'Marxian socialism', Sri Aurobindo, CWSA, 1997, Vol. 25, 488-9, makes the following interesting remark. We will not pursue this point here, other than to note that insofar as there is reluctance on moral grounds to capital inflows into Auroville, it places matters into perspective: 'It ['Marxian socialism'] intends indeed to substitute Labour as the master instead of Capital; but this only means that all activities will be valued by the labour contributed and work produced rather than by the wealth contribution and production. It will be a change from one side of economism to the other, but not a change from economism to the domination of some other and higher motive of human life.'

its own plethora or burst in its straining to a gross expansion. Like the too massive Titan it will collapse by its own mass, *mole ruet sua*.⁹¹⁹

It is this ‘gross expansion’ of the vital impulse, manifested in unchecked greed, expansion and hedonistic satisfaction that forms the outer limit of Auroville’s commercial ideal, not a flourishing vitality or production itself. Indeed, the full and proper manifestation of the Divine as production, the *vaishya* quality, is a necessary part of any integral realization of Auroville, ‘chastened and purified’, not dimmed, ‘by a greater law of truth, good and beauty.’ The moral code for the commercially oriented, Sri Aurobindo notes, is ‘the honour of the Vaishya which maintains itself by rectitude of dealing, mercantile fidelity, sound production, order, liberality and philanthropy.’⁹²⁰ A strong commercial sector is constitutive of an integral perfection, to generate abundance, but not excess: a ‘simply rich and beautiful’, not a ‘cumbrously opulent life’.⁹²¹

That said, greater capital flows, at-scale production and higher productivity will naturally bring in concerns of greed, inequality, self-interest and environmental impact. Aside from the economic reasons for this move considered above, there are ethical and spiritual reasons to engage in commercial strengthening along these lines. For the spiritual experiment to be representative, these inevitable concerns must be addressed at scale and intensity – it is only when serious capital flows begin in Auroville that its communal fabric, and aspiration to fraternity, will be tested. To generate sufficient production – a ‘full life’ – that is yet a ‘true and beautiful life’ is the ideal, for which the fullness of the industrial sector must be given its play. The ideal is not to reject the activity because of the corrupting influences it may bring but to accept and transform them. A model city must demonstrate self-restraint in consumptive patterns, brotherhood despite varying ‘income’ levels, aspiration and offering instead of acquisitiveness, greed, all with significant capital inflows and sums at stake.

These are old ideals. Economic thinking of a long tradition has considered these questions, of the appropriate placement of production, labour and capital, and of economic, moral and spiritual sentiments.⁹²² A comparative reading forms fertile ground to anchor Auroville’s own choices – the ideal, we may easily, and superficially, state is not to hastily reject the economic sentiment, or dull its vitality, but to transform its place in Auroville’s moral economy. In speaking of the ‘advent of the spiritual age’ in the *Human Cycle*, the socio-political charter of Auroville as it were, Sri Aurobindo also makes this point explicit:

These pioneers will consider nothing as alien to them, nothing as outside their scope. For every part of human life has to be taken up by the spiritual, – not only the intellectual, the aesthetic, the ethical, but the dynamic, the vital, the physical; therefore for none of these things or the activities that spring from them will they have contempt or aversion, however they may insist on a change of the spirit and a

⁹¹⁹ Sri Aurobindo, CWSA, 1997, Vol. 25, 79-81.

⁹²⁰ Sri Aurobindo, CWSA, 1997, Vol. 25, 11.

⁹²¹ Sri Aurobindo, CWSA, 1997, Vol. 25, 224.

⁹²² These questions have been richly debated in the literature. See, for example, Roshchild, 2001; Kelly, 2013; Postigo, 2014; Mehta, 2006.

transmutation of the form. In each power of our nature they will seek for its own proper means of conversion ...⁹²³

In some sense, the reluctance on this count is understandable – Sri Aurobindo emphasized that reconciling economic work, emanating from the dynamic, unruly vital – ‘that hard refractory earthy matter which most resists all but a gross utilitarian treatment’ – and spiritual seeking is a difficult task.⁹²⁴ This corrupting influence was weighed on many.⁹²⁵ Indeed, it is telling that Mother signalled the Industrial Zone as a manifestation of *mahakali*, or Strength – whilst knowledge, love and beauty are intuitively recognized as aspects of the omniscient, beneficent and perfect Divine, its aspect of power, are most feared and resisted. Yet, this task too must be undertaken in its fulness, with ‘a mighty passion of force to achieve’, an ‘unegoistic Rudra-power.’⁹²⁶

It is worth noting that in her lifetime, Mother had established several enterprises in the Sri Aurobindo Ashram, given the means and necessity of the time, now significantly expanded. These included the Harpagon Workshop, Machine Shop, Handmade Paper Unit, Pre-Cast Concrete Works, Coco Garden Cement Concrete Works, Honest Engineers and Contractors, Atelier, New Horizon Sugar Mills among others. Auroville’s possibilities today are different and vaster, yet the spirit of openness and integrality of commerce – from factories to high-skill tertiary works – give an indication of the practical bent of Mother’s works.

⁹²³ Sri Aurobindo, CWSA, Vol. 25, 263.

⁹²⁴ Sri Aurobindo, CWSA, Vol. 25, 248.

⁹²⁵ See, for example, for a beautiful discussion, Rothchild, 2001. We may note here that pejorative mentions to ‘capitalism’ and ‘markets’ were common in our conversations – whilst criticism is due, what appeared at times to be an easy labelling is unhelpful.

⁹²⁶ Sri Aurobindo, CWSA, Vol. 23-24, 736; Vol. 32, 19-20 (‘Mahakali is of another nature. Not wideness but height, not wisdom but force and strength are her peculiar power. There is in her an overwhelming intensity, a mighty passion of force to achieve, a divine violence rushing to shatter every limit and obstacle. All her divinity leaps out in a splendour of tempestuous action; she is there for swiftness, for the immediately effective process, the rapid and direct stroke, the frontal assault that carries everything before it. Terrible is her face to the Asura, dangerous and ruthless her mood against the haters of the Divine; for she is the Warrior of the Worlds who never shrinks from the battle.)



(Left, New Horizon Sugar Mills, Foundation Stone Ceremony, 12 April, 1959. Right, Visiting Atelier and Power House, 1953. Source: on file)

This said, requiring a high threshold to begin is inadvisable. This is because in attempting to spiritualize the commercial domain, there is a risk of *dimming* the founts of vitality necessary for productive activity out of fear of what its yet unpurified force may bring, rather than progressively transcending desire and a sense of possession to the supranational roots of life as part of one's *karma* yoga. Practically, if one insists on entirely purified motivations, free of self-interest, the tendency of vital expansionism and a sense of possession, as a precursor to starting an enterprise, one may not begin. Indeed, the obstacles generated by the AVF Act, requiring a 'legal offering', place substantial barriers to commerce in any case. Further entry barriers are unlikely to generate or sustain goodwill and trust that are pre-conditions to working in Auroville. It is trite to say that interest-based incentives that dominate commercial activity are natural and not inconsistent with entry, though far from its ideal. With rectitude, integrity and financial honesty as prior conditions, they are to be substituted in time by deeper ethical and spiritual motivations to work, produce, innovate and serve. Yet, this too is a caricature of a far more complex move, as incentives are usually ordered in complex ways between the scales of egoism and offering to the Divine: a perfect sincerity and pure selfishness are rarely the case. A happy and full life, or indeed even a relatively 'luxurious' one for oneself or one's family and close community are valid and natural motives to work, including in Auroville, if one has 'goodwill' and a 'thirst for progress', Mother's two conditions. Or as Sri Aurobindo put it, if one holds 'as essential the faith in this spiritual conversion ... the attempt to live it out.' The 'form of opinion into which it is thrown does not so much matter', as this foundation can 'be converted into this [form] of living.'⁹²⁷

To expect an entire disinterestedness from the beginning, or place that as the rhetorical starting point, is neither necessary nor productive to developing Auroville's commercial sector. What is required is a cultural and legal architecture that welcomes and enables commercially and

⁹²⁷ Sri Aurobindo, CWSA, 1997, 265.

entrepreneurially oriented newcomers aligned to the vision, who arrive with the natural mix of motivations. A living spiritual culture, as we discuss in Part IV.E, particularly in the sub-zonal collectives of the Industrial Zone where one engages with others on a daily basis, must in the final analysis generate alignment or force exits in time – it, and not an overbearing regulatory environment, is the best means to regulate commercial activity inconsistent with Auroville’s ideals. As Thomas and Thomas note:

A very fundamental idea of most conventional societies is that it is good to own property, so you work hard to buy it or invest in it. But in Auroville the ideal is no private ownership of property: everything is for the good of the larger community. So the fact that people here don’t work for themselves but for the community is inspiring and a very big difference from the rest of the world. I don’t think this is fully appreciated even in Auroville. In our report, we were trying to highlight this motivation in your entrepreneurs because we felt that the non-commercial sector here never fully appreciated the commercial side of Auroville. These entrepreneurs are the ones who are supporting the economy and unless you help motivate them, you won’t get more of them.⁹²⁸

Similarly, a resident aptly notes:

Generalizations, for example that commercial unit holders are primarily interested in enriching themselves rather than in contributing to the collectivity, are also clearly unhelpful in creating a unified approach to revisioning our economy.⁹²⁹

It is a leap of faith to start and operate a commercial unit, in a spirit of collective offering, without expectation of individual profit or reward, especially, as we noted above, when inner offering is correlated to a notified outer one. The uniqueness of the Auroville’s economic experiment lies in testing the following proposition: whether the motive to work, build or innovate, absent the desire of reward or profit within a defined institutional setting, can be inspired by sacrifice or offering to the Divine as manifested in the community?⁹³⁰ This economic model, a practical attempt at Vedantic socialism – built on a spirit of voluntary offering to the collective, the emerging if warring group-soul of which one is a part – requires a welcoming attitude to talent and capital.

The complex mix of motivations, including those that concern the community (greed, acquisitiveness, vital expansion, self-interest etc. that often accompany profit-generation, ‘the characteristic of Life is desire and the instinct of possession’) are natural.⁹³¹ This will almost inevitably bring problems in tow as any serious attempt on the path does – yet, this move from self-interest to service is to be achieved by a progressive purification in time, through

⁹²⁸ Auroville Today, January, 2016, 7.

⁹²⁹ Auroville Today, January, 2016, 7. Similarly, *see*, Henke Thomas’ views, quoted in Majumdar, 2018, 258: ‘Industry has been on the agenda of Auroville from the very beginning. One of the four zones of the city was described by the Mother as the Industrial Zone. But this challenge has been sufficiently taken up ... this implies a welcoming attitude towards commerce and industry ... and the consider what kind of industrial model it wishes to promote.’

⁹³⁰ *See*, for example, Hurley, 2006; Chang and Kim, 2012, for one set of takes on the issue of trade-offs between incentives and productivity, an area for interesting comparative work, where Auroville can provide valuable additions to the literature from its own experience.

⁹³¹ Sri Aurobindo, CWSA, 1997, Vol. 25, 79.

communal contact, camaraderie and the practice of spiritual discipline, not expected as a preliminary condition or rejected at the entry gates. Sri Aurobindo's message during the Indian nationalist movement – damning the 'organized selfishness, cruelty and greed which is dignified ... by the name of industry', yet asking for India to 'create her own conditions ... not only for us but the whole world' – applies with equal force to Auroville's Industrial Zone:

Neither need we fear that the economic revolution will land us in the same diseased and disordered state of society as now offends the nobler feelings of humanity in Europe. India can never so far forget the teaching which is her life and the secret of her immortality as to become a replica of the organized selfishness, cruelty and greed which is dignified in the West by the name of Industry. She will create her own conditions, find out the secret of order which Socialism in vain struggles to find and teach the peoples of the earth once more how to harmonize the world and the spirit. If we realise this truth, if we perceive in all that is happening a great and momentous transformation necessary not only for us but for the whole world, we shall fling ourselves without fear or misgivings into the times which are upon us.⁹³²

Auroville has strong community headwinds in this direction – the generally high rates of contribution from the commercial sector, going in some cases beyond the mandated amount with in-kind contributions and other forms of support, demonstrate a strong sense of collective belonging.⁹³³ Our limited interviews in the sector were replete with a sense of duty. Naturally, a light regulatory system – of the kind discussed above – will be required to guide and check excesses. A *laissez-faire* approach of the 'spiritual anarchist', a free, unregulated and spontaneous exchange, is possible if spiritual states are sufficiently evolved and diffused; if not, unhealthy concentrations of wealth and inequality, leading to social divisions, are possible. A (smart, light-touch) regulatory process will thus be likely required in the meantime, prefiguring the long approach-way to Mother's ideal.

Even here, it is important to ask what levels of inequality are morally permissible in Auroville – Mother and Sri Aurobindo's ideal is not 'strict egalitarian', where everyone gets the same, but 'sufficientarian', where everyone gets enough (the basic necessities), however that minimum is identified.⁹³⁴ Beyond that, a diversity of lifestyles and variation, in material terms as well, is anticipated and necessary as part of the free variation of life ('each is free to organize this life'). In terms of housing, for example, Mother was clear:

I am in favour of some diversity in the types [of accommodations], in accordance with the types of residents.⁹³⁵

⁹³² Sri Aurobindo, CWSA, 1997, Vols. 6-7. 906.

⁹³³ We may note here, in passing, that contributions given in an ethic of reciprocity and mutuality between members of the community are important and valuable, indeed expected in Sri Aurobindo's scheme. These may be made in anticipation of fair interchange, in the greyscale from calculated self-interest to altruism and care. Justifications along these lines are advanced to explain the legitimacy of *de jure* taxation in contractarian systems. It is an empirical matter as to the role these motivations play in the Auroville collective. But a distinction can be drawn between such reasonable exchanges and an offering in the spirit of *karma yoga*. It also bears noting that there is no necessary correlation between the amount one contributes and this inner fact of offering: the quality of the offering is important. This requires a fuller discussion – it is an interesting area for future research.

⁹³⁴ See, in general, Herlitz, 2018; Alder and Norheim, 2022.

⁹³⁵ Guigan, 2018, Vol. 1, 10.

This diversity naturally will have to (either naturally, in a freely ordered brotherhood, if collective levels of consciousness so operate, or in a regulated way) operate within limits, as solidarity is usually inconsistent with inequality gulfs beyond a point. The free play of liberty and diversity will naturally bring in concerns of monetary status-markers, envy and power to dictate collective issues based on income levels, which dent solidarity. Relating this to our discussion in Part I.C, the *rajasic* temper – that of enterprise, dynamism and power, central qualities for entrepreneurial activity needed in Auroville today – is liberative, leading to innovation and productivity gains, yet also competitive, leading to an ‘ordered conflict’, with each vying for a convenient distributive pattern. Mother’s ‘Dream’ – where individual value would have a greater importance than the value due to material wealth and financial position – was addressed to this concern, common in *laissez-faire* arrangements (‘the opulent plutocrat and the successful mammoth capitalist and organiser of industry are the supermen of the commercial age and the true, if often occult rulers of its society.’) These are already in play in Auroville, albeit at a very small scale, and under-discussed.⁹³⁶ The twin concerns of liberty and equality, individualism and collectivism, here as elsewhere, tend to division and uniformity in their extremes, an excess of *tamas* or *rajas*. They can, in Sri Aurobindo’s view, only be reconciled through a fraternal union, in early stages born of vital and intellectual association – with a growing *sattva*, the quality of harmony and poise – but ultimately through a deeper kinship of the soul, the base of the holy trinity of a healthy polity, ‘the Divine anarchy’.

As elsewhere, Auroville’s political economy will reflect its collective culture, creating pressures and opening up new possibilities that need to be explored (‘his economic state and social institutions are themselves governed by his psychological demand on the possibilities, circumstances, tendencies created by the relation between the mind and soul of humanity and its life and body’).⁹³⁷ Thomas and Thomas’ short remark point to this issue, which requires careful study:

The level of income inequality amongst Aurovilians has become a soul-searching issue. There is a considerable difference between those Aurovilians who are living only on a maintenance provided by the community; those who live on a maintenance plus some outside sources; and those who have their own outside sources. Many very

⁹³⁶See, for example, for a discussion on inequality in Auroville, Auroville Today, January, 2016 (‘These tensions and inequalities are exacerbated, says another, by the present system where commercial unit managers are able to pay themselves far more than people in the services receive. ‘Their argument is, you see how hard we are working, we are making a lot of money for Auroville, so we deserve more remuneration than those who are just working in services. Somehow, the people who are making money seem to feel this is something more ‘real’, more valuable, to the community than ‘merely’ providing a service.’ ‘There is much less sense of connection, of collective responsibility today,’ notes another.’ We all have our individual accounts which are treated as private property to use as we like. If we have financial means and pay a fixed monthly contribution – which doesn’t at all reflect the true cost of providing the services and benefits of living here – we can live very comfortably and not be involved in any work for the community. ‘One of the participants notes that Auroville has become a kind of ‘California in Tamil Nadu’, with its upmarket boutiques and expensive eateries. ‘Many of those who have lived here for years cannot afford to purchase these goods or even to eat in our restaurants,’ she notes. ‘This is a recipe for social tensions and encourages a preoccupation with money’). See also, Auroville Today, Nos. 407-8, June-July, 2023 for a short discussion on cost-of-living concerns, with executives forced to account personal expenditure on the unit, technically impermissible under Appendix 3, rule 1 of the Code of Conduct, 2017.

⁹³⁷ Sri Aurobindo, CWSA, 1997, Vol. 25, 28.

well to do people do not appear in the Auroville statistics, which makes the statistical analysis weak. But that there is much inequality is indisputable.

Inequality is a worldwide issue at the moment. Mainstream economists such as Anthony Atkinson and Thomas Piketty see income inequality as the major barrier to progress in the world. Auroville should address the issue. For if there is income inequality which is not recognized, throughout history it has been shown to create tension and undermine solidarity. If Auroville is to be a model for the world also in this area, it should be prepared to be scrutinized on this issue and show answers.

While we are not advocating that everybody should earn the same, we propose that Auroville reconsider the monthly contribution amount. At present, each unit pays for each Aurovilian working in that unit a flat amount, while those who have their own sources of income pay for themselves the same amount (Rs 3,150 / month). We suggest that this system is changed into a progressive contribution system relative to one's total income, where people who have more pay more, so as to create a fund where those that are better off cover those who are worse off. [progressive contribution slabs] We acknowledge that it will be impossible and most probably against the spirit of Auroville to control this. The success of this system will depend on the honesty and level of consciousness of each individual.⁹³⁸

These are the socio-psychological challenges attendant to an at-scale communal yoga which will require a robust inner and outer response, at the individual and collective level, in terms of cultural and institutional design. They are all the more reasons, spiritual ones, to engage the challenge of building the Industrial Zone, for Auroville to be a representative 'model' city that can guide and inspire others. A strong commercial sector demands vitally strong individuals to drive the next generation of enterprise in Auroville – 'the Aurovilian entrepreneur of tomorrow will need to be a bold and brilliant type ...', 'she [*mahakali*] is loved and worshipped by the great, the strong and the noble.'⁹³⁹ If enabled by an open and welcoming environment, with progressive acculturation to the ideal, this offers exciting possibilities to take the experiment forward integrally towards a fraternal *and* commercially vibrant economy. For this, Auroville needs a decisive commitment to enable commercial activity, a restructure of the legal architecture to open financing options and a fit-to-purpose governance frame.

o. Specifying the 'No-Money-Exchange' Ideal

The vision for money in Auroville has been the subject of intense debate. Subject to varied interpretations, some have emphasised its power and necessity as a means to achieve collective prosperity, whilst others have sought to limit or eliminate the exchange of money with an in-kind economy in Auroville. Intertwined with these debates are those relating to the 'prosperity' ideal, to secure equitable economic growth that can provide basic necessities to all residents, through the Central Fund-supported maintenances, unit-linked maintenances, a 'universal prosperity package', a city-wid

⁹³⁸ Auroville Today, January, 2016, 7.

⁹³⁹ Thomas and Thomas, 2013, 169; Sri Aurobindo, CWSA, 1997, Vol. 32, 20.

e gift-economy, the ‘Aura’ platform etc.⁹⁴⁰ As of 2023, the FAMC Mandate (approved in 2016) ‘requires it to ‘eliminate the exchange of money between Aurovilians’, yet the precise scope of that task is unclear. Similarly, the 2015 Retreat identified the Auroville needs ‘to provide in-kind in every field (including services starting with basic services such energy, water, food, mobility etc). This will reduce circulation of money. Auroville must achieve the vision of an economy-in-kind within a time frame.’⁹⁴¹

On the issue of money, Mother made several comments. In December 1965, when asked the question, ‘will money be used in Auroville?’, she first wrote ‘as long as human habits will be such’, but later, in October, 1969, changed this to: ‘No, Auroville will have money relations only with the outside world.’⁹⁴² Alongside, when asked the related distributive question, ‘how will work be organised and distributed in Auroville?’, she replied:

Money would be no more the sovereign lord. Individual value would have a greater importance than the value due to material wealth and financial position. Work would not be there as the means for gaining one’s livelihood, it would be the means whereby to express oneself, develop one’s capacities and possibilities, while doing at the same time service to the whole group, which on its side, would provide for each one’s subsistence and for the field of his work.⁹⁴³

There is a different tact in a prior conversation in the *Agenda*, dated June, 1965, where Mother described an early formation that she had made in 1938 – which serves for wonderful reading, and demonstrates her dogged persistence to found Auroville forty years later at the age of ninety:

There was no money—within the walls, no money; at the various entrances, there were banks or counters of some sort, where people could deposit their money and receive tickets in exchange, with which they could obtain lodging, food, this, that. But no money—the tickets were only for visitors, who could not enter without a permit. It was a tremendous organisation ... No money, I did not want any money.⁹⁴⁴

As Guigan notes, the industrial sector, in this formation, was outside this ‘no-money’ zone’.⁹⁴⁵ However, she noted that now, in Auroville, as it was still being planned:

... there are only four zones, and no walls. And there will be money.⁹⁴⁶

⁹⁴⁰ See, for example, Auroville Retreat, 2015, 25-6, 42-4, 65; Ayer et. al., 2019, 8-10, Clarence-Smith, 2019, 174-208; Auroville Radio, 2017; Town Development Council Annual Development Plan, 2014-15, 4-10; Ghisi, 2010; Exploring Prosperity, 2018.

⁹⁴¹ Full Report, Auroville Retreat, 2015, 25.

⁹⁴² Guigan, 2018, Vol. 1, 129.

⁹⁴³ Guigan, 2018, Vol. 1, 129. This answer again was introduced later.

⁹⁴⁴ Guigan, 2018, Vol. 1, 109.

⁹⁴⁵ Guigan, 2018, Vol. 1, 30, fn 1.

⁹⁴⁶ Guigan, 2018, Vol. 1, 109.

Later, in December, 1967 Mother again remarked on the distributive question of collective provisioning of ‘the most elementary necessities’, the prosperity ideal, with space beyond that for everyone to ‘be free to organize ... life’:

The true part is that every human being has the material right ... (but it’s not a ‘right’ ...). The organisation should be such, arranged in such a way, that everyone’s material need should be met, not according to notions of right and equality, but on the basis of the most elementary necessities; then, once that is established, everyone must be free to organise his life.⁹⁴⁷

Finally, three years later, in March, 1970, in a discursive conversation, she seemed to be inclined to a ‘coupon for hours of work’ system, though many possibilities were being considered to work out a proper system. It had to be ‘something based on the work’, a reciprocal arrangement where one’s collective provisioning was earned. We quote the exchange at length:

Satprem: A system of ‘coupons for hours of work,’ and a scale of the quality or degree of the work done.

Where is that practiced?

S.: I don’t know, in my imagination!

Oh, that’s you. Yes, of course, that’s very good!

S.: Something based on the work.

Yes.

S.: Coupons for hours of work. Then if a coolie’s coupon is worth one, an engineer’s may be said to be worth five, for instance. That’s all.

That would be a whole organisation to be worked out. We’ll need ... we’ll need something like that in Auroville.

S.: Based on the work.

Yes, an activity. That work could be defined as an activity with a collective usefulness, not a selfish one.⁹⁴⁸

As Guigan pointedly notes in relation this conversation, there is a tension between relating collective provisioning to qualification, which introduces a differential wage / income system:

Can it be said that Mother approved the system proposed here by Satprem? If so, did she hear properly Satprem’s [her interlocutor] suggestion? Giving more to people with a higher qualification is NOT at all the system she described in ‘A Dream’ and had put in place at the Ashram.⁹⁴⁹

The ‘no-money’ ideal has been discussed since 1973, after Mother’s passing, in a host of ways, though with an imprecise specification of its conceptual basis and operational details. As in other matters, her comments require further detailing out as between alternate systems. In what

⁹⁴⁷ Guigan, 2018, Vol. 1, 223-5.

⁹⁴⁸ Guigan, 2018, Vol. 1, 286.

⁹⁴⁹ Guigan, 2018, Vol. 1, 86, fn. 1.

follows, we offer some brief reflections based on the exchanges quoted above in relation to these choices:

First, what is clear from Mother's words is that she supported a just distributive arrangement insofar as the 'elementary necessities' of life went. That, however, says little. The following inferences may be drawn from her words:

- i. Mother supported a distributive regime that is 'sufficientarian', a society's obligation to provide universally for basic needs (the 'prosperity ideal'), not necessarily 'prioritarian', where every additional amount spent is directed to the lesser well-off or strictly 'egalitarian', where all have the same. Indeed, she explicitly rejects the last, as an unhelpful 'levelling-down'.⁹⁵⁰
- ii. In this, after basic needs ('primary goods', in the literature) having been met, she contemplated a diversity of material positions for residents ('once that is established, everyone must be free to organise his life'), but for each, progressively without possessiveness, leading to voluntary contributions / fraternal (not coerced) redistribution beyond the minimum universal provision.
- iii. She was sensitive to the free-rider concern (that provisions have to be 'earned', with contributions of work or money, with reciprocity as the ethical justification), an under-discussed problem in Auroville by some accounts.
- iv. Her remarks are not decisive on the issue of proportionate payment based on work. She was mildly inclined to a coupons-for-work system based on qualifications in one conversation, yet also indicated (publicly, and repeatedly) that competitive relations based on material status-markers, including monetary ones, are not in line with Auroville's ideals (a point also made by Sri Aurobindo); whilst elementary necessities are not tied to a graded system, it is an open question as to how the material diversity will organize itself, whether based on the amount one contributes (which raises measurement issues, particularly for in-kind or service work), one's productivity / surplus generation, qualifications or need. The last of these, often voiced in conversations on this issue in Auroville, imagines personalized provisions, beyond the basic minimum, which raises (a) a practical problem of specification at scale, (b) an epistemic problem, for definitions of need and wants may differ, and (c) a socio-political one, for centralized assessments of need or wants will invite a concentration of power with historical examples demonstrating its dangers. As an alternate, honesty-based self-reported needs have been proposed and in part practiced in small groups with light 'checks', but the feasibility of at-scale systems for this practice for non-essential items have not been discussed.

⁹⁵⁰ See, for an overview, Adler and Norheim, 2022, Herlitz, 2018. Comparative work with modern theories of egalitarianism (in its various forms) and moral desert may be an enriching research project in Auroville.

- v. She recognized the need and necessity for money and capital flows for the productive sector, in commerce, industry, agriculture etc.
- vi. She considered the possibility of a pegged informal community-currency (imagined in the 1938 formation, but dropped later), to be exchanged for formal currency / ‘money’. This, it bears noting, is money in another regulated form.
- vii. Her early conversations were open-ended and open to experimentation, attempting to find a practical solution to meet the underlying concerns of just distribution and sufficient at-scale production, mindful of both levelling-down and *tamasic* attitude on one hand and the alienation from one’s fellow beings / greed / self-interest / vital expansion that ‘money relations’ bring, ills attendant to what Sri Aurobindo described as ‘commercialism’.

Second, given this, we may distinguish between two issues, at times conflated in the records: those of distribution and those of money-exchange. Securing a just distributive ethic – the ‘prosperity ideal’, universal, linked or otherwise as in various proposals – is central to Mother’s and Sri Aurobindo’s vision, as indeed generally in the literature since. This, however, is distinct from the issue of money-exchange: just distribution may be created in monetized *or* non-monetized systems. The *substance* of Mother’s ideal – that ‘money is no longer the sovereign lord’, ‘the community would ‘on its side ... provide for each one’s subsistence and for the field of his work’ – is to secure just and reciprocal distribution of basic needs and opportunities. This collective provisioning may be provided in a fair monetized system, the subject of long-standing debate in the literature. The *form* of her ideal – whether Auroville’s internal economy involves exchange of money – is a distinct issue, on which she expressed differing and inconclusive views. We thus suggest that in making choices, the substance, not the form, dictates policy.

Third, in June, 1965, Mother said there would be ‘money’; in December of that year, she said ‘as long as human habits will be such’, but later, in October, 1969, she said ‘money relations’ will exist only with the outside world. It is thus useful to ask what Mother’s position was on the question of money-exchange. As a historical matter, in Auroville’s early days, basic necessities – ‘bed, bedding, mosquito net, toiletry items and clothing if necessary’ – were provided, but a ‘monthly support fee’ was paid, with exceptions approved by the Mother if necessary.⁹⁵¹ From this, it would seem that monetary-exchange, if fair, as was the case then, is permissible. The substantive concern carries greater weight than the formal one. More substantively, the issue depends on what one means by ‘money.’ This is a question investigated in monetary theory – it is beyond our scope and domain, but we may note that none of the traditional theories of money, the commodity or credit views, nor indeed of market exchange are necessarily inconsistent with Mother’s ideal.⁹⁵² Dialogue with the literature will be valuable

⁹⁵¹ Thomas and Thomas, 2013, 65.

⁹⁵² For market exchange mechanisms arguably consistent with Mother’s ideal, *see*, generally, Albertson, 2018; Miller, 1989; Satz, 2010; Moulin, 1987; George, 2010; Bauman, 2017; Néron, 2015. For conceptualizing ‘money’, *see*, generally, Hicks, 1989, 41-6; Ostroy and Starr, 1990; King and Plosser, 1986; Kitamura, 2022; Guala, 2021; Dick, 2021.

to arrive at a feasible, coherent and specified conception of the ‘no-money-exchange’ ideal, particularly as identifying exchange metrics for at-scale in-kind support will be challenging as numbers grow.

Fourth, in designing an exchange system, there are three distinct issues to consider: the form of the exchange, the fairness or justness of the exchange and introduction of market mechanisms to regulate that exchange in spheres that operate with non-transactional values.⁹⁵³ The appropriate regulation of monetary exchange – in financial and value-based terms, across spheres of life in Auroville (economic, schooling, housing, healthcare, food etc.) – is a knotty question. It will require a nuanced articulation of the value and limits of market-mechanisms and / or systems of monetary exchange, neither of which are *a priori* inconsistent with Mother’s ideal, but possibly so in *some* forms. This nuance does not seem to reflect in current discussions on the ‘no-money-exchange’ ideal in Auroville in our albeit limited interviews on the issue – for Auroville to be a ‘bridge between the past and the future’, take ‘advantage of all discoveries’, a robust engagement with the literature anchored in the proposed research frame will be valuable.

Fifth, a distinction between money as a means of payment and money as a common store of value to permit exchange across goods and services. The former concerns a ‘how’ question (how one transacts) and the latter concerns a ‘what’ question (what money is).⁹⁵⁴ Auroville is currently a ‘money’ economy despite the financial service accounts system on which collective provisioning rests, as this relates to the means by which one pays (account transfers), not the form of paying itself. It is money in another form. As Thomas and Thomas note:

For example, Auroville always wanted to have a no money economy. So far you’ve come up with a kind of debit card system, which means that most of the time you don’t have to carry cash, but this is just money in another form. The problem is your economy is very interwoven with the outside world, and in an economy that is not closed and so porous you can’t have a no cash system; it clearly will not work.⁹⁵⁵

Sixth, we suggest a distinction between ‘money relations’ and ‘money exchange.’ In her ‘ideal’ formation of 1938, Mother imagined an exchange of formal currency for tokens, which would serve as ‘internal’ money. One would imagine that the exchange system would grant more internal tokens to greater formal currency. If so, Mother’s underlying concern, however, would remain. This concern, the emphasis of her ‘Dream’, was with the ills of vital expansionism, unchecked competition and status-markers attached to financial position and wealth that ‘money relations’ (understood here as the set of social relations that may, but need not, come in tow with market-arrangements, in contrast to monetary exchange *per se*) bring, including those discussed at length by Sri Aurobindo. In this reading, the concern is to develop a just distributive ethic, which may be compatible with different forms of exchange, including monetary exchange. The thrust of the question is not with monetary exchange as such, but the

⁹⁵³ See, Calrence-Smith, 2019, 210-237, for interviews on the issue of communal solidarity and monetary exchange, particularly in relation to the Pour Tous Distribution Centre. See, in general, for this debate, yet incipient in Auroville, Satz, 2010; Sandel, 2012.

⁹⁵⁴ See, Yang, 2007.

⁹⁵⁵ Auroville Today, January, 2016, 7.

social-economic ills attendant to certain institutional market arrangements. The latter may equally be avoided in a fairly constituted and run monetary system. Whether that is assured through a market-arrangement for free trading of certain goods, or a centralized distribution system for others, or most likely, a regulated system in between, is the substantive concern, debated at length in the literature.⁹⁵⁶ Yet, the distinction between just distribution schemes / the prosperity ideal and forms of monetary exchange is important to note.

Our brief discussion here is to clarify the questions that arise for consideration with reference to Mother's words. Each will require informed community backed by an expert-led research frame to arrive at concrete and at-scale specifications for an appropriate system of exchange, monetary and / or in-kind. It bears emphasizing that while these questions are important to consider, this should not be at the expense of policy action on the productivity and growth concerns addressed above – absent sufficient value generation, distributive issues may be rendered moot.

p. Scale, Specialization and the Future of Work

At its current population levels, Auroville is severely constrained in terms of generating sufficient economies of scale, in terms of capital, human resource and infrastructure. Establishing a self-sustaining economy with 2500-3000 residents is neither desirable nor intended in the original vision, even if possible. In practice, it has led to cyclical stagnation, identified in the TDC Annual Development Plan, 2014-15 and Ayer et. al. A critical population density must be reached to trigger the dynamism that urban centres characterize. As we discussed with reference to the historical trajectory in Part III.A and consider in Part IV.D looking forward, a concerted push to increase population numbers through strategic interventions consistent with the ideal are necessary – in particular, at current levels, it appears that the necessary specialization and division of labour required to attend to necessary productivity increases vis-à-vis economic growth and tertiary research activity is a major concern. A fuller examination of the complex literature on the subject is required to determine a population profile consistent with Auroville's economic, cultural and spiritual ambitions.⁹⁵⁷ The Masterplan provides a broad policy guideline on population distribution, but specification is required, particularly as regards professional and tertiary domains in which Auroville has limited internal capacity, to allow for conscious outreach and entry processes along those lines. This is particularly so given Ayer et. al.'s worrying find as of 2019 that 'the employment of Aurovilians in commercial units is not in proportion to the population growth'.⁹⁵⁸

Demographic details or surveys on residents' expertise (accredited or self-taught), qualifications and areas of work, currently not conducted, will be helpful to ascertain the current spread. We anticipate that the move from 'generalists' to 'specialists' will be required to generate research (and economic) work consistent with Auroville's ideal to be the 'greatest seat of knowledge upon Earth'. Indeed, the depth and texture of cross-cultural interchange envisioned as part of Auroville's constitutional imprint too demands this diversity.

⁹⁵⁶ See, for an overview, Olsaretti (ed.), 2011.

⁹⁵⁷ See, for example, Littek, 2001; Ucak, 2015; Yang and Ng, 1998.

⁹⁵⁸ Ayer et. al., 2019, 8.

Anecdotally, it appears that many residents are currently engaged across a range of activities, at times voluntarily to expand horizons and at times, of necessity due to unavailability of human resources to attend to that task. Whilst naturally individual choice to work, learn and research across domains is an essential feature of a learning society, expertise in tertiary work, economic or otherwise, is correlated to time. Trade-offs will therefore have to be made – this requires reflection both as a matter of policy and at an individual level to balance the twin pulls of focussed work in the chosen area of specialization to develop expertise and multi-disciplinary learning, whether as a hobby or more.

More generally, developing sufficient scale and tertiary skill can lay the foundation for Sri Aurobindo's ideal of a spiritualized society:

The aim of its economics would be not to create a huge engine of production, whether of the competitive or the cooperative kind, but to give to men not only to some but to all men each in his highest possible measure the joy of work according to their own nature and free leisure to grow inwardly, as well as a simply rich and beautiful life for all.⁹⁵⁹

To achieve sufficient material gains that allow 'free leisure to grow inwardly' was also Mother's ideal:

When I was in France, I was always asking myself, 'How can people have the time to find themselves? How can they even have the time to understand the way to free themselves?' So I thought: a place where material needs are sufficiently satisfied, so that if you truly want to free yourself, you can do so. And it was on this idea that the Ashram was founded, not on any other: a place where people's means of existence would be sufficient to give them the time to think of the True Thing.⁹⁶⁰

This translates into the Auroville context today as follows: to sustain, if not increase, the currently modest (and by many accounts, insufficient) levels of maintenance, Auroville will either have to institute productivity increases through a manufacturing / tertiary sector, the latter of which requires high-skill specialization, or generate greater per capita involvement in the commercial sector, which will not solve the structural concern and more so, disallow the necessary time for higher (or other) pursuits. Equally, to 'give to men ... each in his highest possible measure to joy of work according to their own nature' requires a diversification of the commercial profile discussed above (which needs to be backed again by expertise / specialization), such that work opportunities across the primary, secondary and tertiary sectors are available to all temperaments, with available capital and prior investment in infrastructure and human resources that can sustain such a setup. The ideal is well-within reach: a flourishing at-sufficient-scale commercial setup, utilizing technology-enhanced / automation-enabled productivity increases where possible and strategic entry into high-skill areas to develop goods, products and services that can express Auroville's ideal as a city dedicated to research.

⁹⁵⁹ Sri Aurobindo, CWSA, 1997, Vol. 25, 257.

⁹⁶⁰ Guigan, 2018, Vol. 1, 28.

Casting a glance at the future, debates on the future of work are important for Auroville to explore, through the proposed research centre or otherwise, in its economic design, particularly as it resonates with Mother and Sri Aurobindo's thought. This debate has old origins: back in 1928, Keynes, the 'father' of modern economics, spoke of the 'economic possibilities of our grandchildren.'⁹⁶¹ He recognized, with Sri Aurobindo, that industrial progress was a 'soiled creed, black with coal dust and gunpowder', yet he proposed that if capital equipment continued to grow at 2 percent a year and technical efficiency at 1 percent, 'the standard of life in progressive countries one hundred years hence will be between four and eight times as high as it is today.' He concluded thus that the 'economic problem', the problem of having to meet basic necessities, 'would be solved ... within a hundred years.' He thus argued that 'for at least another hundred years, we must pretend to ourselves and to everyone that fair is foul and foul is fair; for foul is useful and fair is not. Avarice and usury and precaution must be our gods for a little longer still. For only they can lead us out of the tunnel of economic necessity into daylight.' Speaking a few years after the *Arya*, in which Sri Aurobindo's description of 'economic barbarism' came, Keynes' paradoxical logic recognized the moral and spiritual blackening of the times. Yet, for him, these private vices could serve a public end, that of securing sufficient material production to serve our basic needs, thus freeing up time and leisure for the higher pursuits, however we define them, which formed the *true* ends of life. Money, in Mother's words, would no longer be the sovereign lord and work would not be for sustenance and wages but as expression of our higher faculties. Skidelsky notes:

Keynes understood that capitalist civilization had, at some level of consciousness, undertaken to license motives previously condemned as 'foul' for the sake of future reward. It had struck a bargain with the forces of darkness, in return for which it would secure what earlier ages could only dream of—a world beyond the toil and trouble, violence and injustice of life as it actually is.

On the way, the idea of moral limits to human ambition, which underpinned all pre-modern conceptions of the good life, was lost, and dormant energies of creativity and destructiveness were set free in the hope that they would carry humanity to a pinnacle of achievement and mastery of the natural world. At various stages on this journey, the greatest thinkers of the age tried to envisage an end state, a point at which humanity could say 'enough,' only to find that the machine it had created was out of control, a Frankenstein's monster that now programmed the game of progress according to its own insane logic. This is the story of how it happened—how we came to be ensnared by the dream of progress without purpose, riches without end.

...

What Keynes meant by this was that humanity would be able to satisfy all its material needs at a fraction of existing work effort—at most three hours a day to 'satisfy the old Adam in us.' The abundance of time thus freed up might lead to a 'nervous breakdown' of the kind already common among 'wives of the well-to-do classes.' But Keynes hoped not. Rather, he looked forward to a moment when the spontaneous,

⁹⁶¹ See, in general, Skidelsky and Skidelsky, 2012, for a discussion on this idea. Quotes from Keynes below are taken from their work.

joyful attitude to life now confined to artists and free spirits was diffused throughout society as a whole.⁹⁶²

It is thus in reorienting production (the means) to spiritual pursuit (the end) that debates on the future of work are important in Auroville. Indeed, technological advances since Mother's passing in 1973 have developed considerably, and as such, Auroville's economic model can draw the benefits of these developments through strategic planning measures discussed above and in other studies, whilst not enslaving itself to purely economic ends. To marry the productive gains made possible by this period of economic materialism with the spiritual drive, is, as Sri Aurobindo notes, the integral ideal:

As we have seen how greatly Materialism has served the ends of the Divine, so we must acknowledge the still greater service rendered by Asceticism to Life. We shall preserve the truths of material Science and its real utilities in the final harmony, even if many or even if all of its existing forms have to be broken or left aside.

Science has put at his disposal many potencies of the universal Force and has made the life of humanity materially one; but what uses this universal Force is a little human individual ... with nothing universal in its light of knowledge or its movements, no inner sense or power which would create in this physical drawing together of the human world a true life unity, a mental unity or a spiritual oneness ... It is such a change and such a reshaping of life for which humanity is blindly beginning to seek, now more and more with a sense that its very existence depends upon finding the way.⁹⁶³

Debates on the future of work, however, have not adhered to Keynes' prophecy – productivity gains and a democratization of basic necessities have not allowed us to become 'free spirits', but generated an engine of consumption-led growth, leading to calls for 'limits to growth', questioning the ethical underpinning of the unchecked economic engine.⁹⁶⁴ Sri Aurobindo anticipated this, likening the life-power of the economy to 'an engine in which the locomotive force has made the driver its servant and not its controller'. Pointing to the future of work, he notes:

Certain prophetic voices announce indeed the speedy passing of the age of commercialism. But it is not easy to see how this is to come about ... The end of commercialism can only come about either by some unexpected development of commercialism itself or through a reawakening of spirituality in the race and its coming to its own by the subordination of the political and economic motives of life to the spiritual motive.⁹⁶⁵

Recent debates given automation, artificial intelligence and machine learning have revived these concerns of re-awakening value and meaning amidst economic growth – in either case, the questions raised are important for Auroville's future planning. One may see work as

⁹⁶² Skidelsky and Skidelsky, 2012, 26-7, 60-1.

⁹⁶³ Sri Aurobindo, CWSA, 1997, Vols. 21-2, 28, 1092.

⁹⁶⁴ See, Skidelsky and Skidelsky, 2012, for an accessible and broad-ranging discussion.

⁹⁶⁵ Sri Aurobindo, CWSA, 1997, Vol. 25, 487-8.

instrumental to material ends, such that one may use the fruits of technology and increased productivity to generate time for higher pursuits, or one may see work as expressive, giving meaning to one's existence, in which case one must manage the disruptive effects of these shifts that threaten to render human labour redundant.⁹⁶⁶ References to both the leisure and time-developing and expressive value of work are found in Mother's discussion. How one subordinates the economic motives of life to the spiritual motive in this landscape is thus both a matter for inner work in the spirit of *karma* yoga and a policy design question to develop an appropriate economic profile for Auroville.

*

⁹⁶⁶ See, Skidelsky, 2020.

G. AGRICULTURE

i. Early Efforts

True to the local Irumbai legend, the degraded and barren plateau of the late 1960s – thought to be ‘impossible’ for agriculture – was transformed into a tropical dry evergreen forest by the exemplary work of the early Aurovilians.⁹⁶⁷ As an early resident noted:

When Auroville started in 1968 the whole area was a barren plateau lacking local resources of water, vegetation and functional villages, resulting a very unpredictable and poor ecosystem. It was already denuded of nearly all vegetation, and frequent wind storms and monsoon deluges stripped it further of its meagre topsoil, carving ravines as rain water poured down from the plateau into the sea.⁹⁶⁸

From the 1970s, an unprecedented afforestation and land regeneration drive was undertaken as part of which over 2 million trees were planted over 32 years across more than 2,500 acres of land. The history of this work has been chronicled in detail, and we will thus keep our overview brief.⁹⁶⁹

The regeneration efforts followed a painstaking, nurturing and patient four-stage process, in line with the natural cycle of things. The first was of biomass production, which involved live soil formation. This was followed by the introduction of grass species, which increased soil depth and introduced the capacity of water retention, fostering conditions favourable for a thicker layer of vegetation including woody annuals, herbaceous plants and deeper-rooted shrubs. Annual wooded plants gave way in time to a cover of perennial trees. Sunlight intensive growth was pushed to the periphery, making space for trees at the beginning of their life cycle at the centre. This stage was characterized by increasing diversity of vegetation, an increasing density per unit of biomass and increasing height and depth of species. Alongside, seed dissemination was catalyzed. Finally came the climax vegetation. In this stage, the growth of vegetation reached maturity, developing into a forest with ‘maximum biomass per unit of surface’.⁹⁷⁰ Alongside, important early efforts were made to control soil erosion and arrest water flow came through the building of check dams, many still identifiable today. The remarkable transition of the landscape, aesthetically and productively, is a testament both to the dedication and wisdom of the early pioneers and the local villagers and to the spiritual and environmental ethic that is pillar of Auroville’s founding ideal. The 2014 Green Belt Land Use Plan records this achievement:

In the course of the past 47 years, they have established farms, orchards, water management systems and planted more than 3 million trees. This later effort has significantly altered the climate and liveability of the area, providing shade, habitat

⁹⁶⁷ Masterplan 2001, 17.

⁹⁶⁸ Thomas and Thomas, 2013. 109.

⁹⁶⁹ See, for example, Masterplan, 2001, para. 1.5.

⁹⁷⁰ Auroville website, ‘Natural regeneration of vegetation’, 2014.

for wildlife, enhanced water retention and aquifer recharge, and control of the storm runoff which had badly eroded many of the stream beds.⁹⁷¹



In terms of the evolution of farming, the first subsistence efforts came out of sheer necessity when the first lands were purchased in the 1960s. As land regeneration began to pick up speed, increased soil formation and fertility, along with rising water tables, allowed for the possibility of greater agricultural activity. In 1978, 13 Auroville farms – most organic – organized into a cooperative system which was later re-organized in 1994 as the Auroville Farm Group. Yet, forestry, not farming, seems to have been the primary preoccupation. In this period, as Auroville’s ecological work began to yield rich fruit, national and international recognition followed. The Government’s support for the AVF Act of 1988 was in no small measure due to the ecological work done at the time. The flow of albeit modest government grants in the early 80s followed and a wave of support from ecologists globally placed Auroville on the green map. For example, the following statements made by a member of the Rajya Sabha during the passage of the Auroville (Emergency Provision) Amendment Bill in 1985 and by Ms. Hanna Strong, a member of the second interim International Advisory Council at the time reflect the general sentiment:

I support the Bill because in order to restore ecological balance of a severely deforested and eroded land an extensive programme of afforestation, erosion control and soil conservation has been launched by the management. And more than 1.5 million trees have been planted with the result that this eerie, desert land is being turned into a green belt.⁹⁷²

...the community has done exemplary work in reforestation, appropriate technology, renewable energy, environmental education, low-cost environmental housing, traditional medicine, seed banks, and training programs in sustainable and appropriate agriculture.⁹⁷³

By the early 2000s, even as more land was yet to be acquired and reforested, the focus turned towards research and consultancy. The Auroville Forest Group and the Auroville Centre for Ecological Land Use and Rural Development (Palmyra) were formed to coordinate activities around soil and water conservation, afforestation, wasteland reclamation and offer training programmes for students, farmers and others to promote sustainable land use in the bio-region.

⁹⁷¹ Stein and Stein, 2015, 7.

⁹⁷² Rajya Sabha Debates, 1985, 376.

⁹⁷³ Minutes of Second Meeting of the International Advisory Council, 1986.

The Forest Group is tasked today with conservation and protection of the forests and water resources, afforestation and regeneration in the surrounding bio-region, alongside environmental education and awareness. Research and scientific study are now undertaken, with a variable emphasis, on restoring the indigenous tropical dry evergreen forests, study of natural soil regeneration process, impact of the use of chemical pesticides, strengthening knowledge on indigenous medicinal plants and forming an Auroville eco-database. In this, Auroville stewards and units offer consultancy services across the country to aid and guide reforestation and conservation efforts. While only a few enclaves of the climax forests are to be found in Pondicherry across Pondicherry University and villages of Kuyilapalayam and Pillaichavadi, Auroville has a rich growth of mature forests including species like the *Mimusops elengi*, one of the largest trees of the original climax vegetation. Today, the majority of this reforested land lies along Auroville's thick Green Belt, which is organized into 29 stewarded forest areas – represented focally under the Forest Group – including Pitchandikulam, Aranya, Sadhana, Revelation, Palmyra, Martuvam, Success, Bliss, Udumbu, Silence, Hermitage, Siddhartha, Samridhi, Baraka, Eternity Forests and others. The exemplary work of the stewards in regenerative ecology, and the flourishing Green Belt that it has sustained, has been internationally recognized, with a body of literature documenting the work. Looking to the future, the forestry sector is critical to sustain an ecologically vibrant urbanism, both for non-tangible benefits – biodiversity, recreation and rejuvenation – and sustainable resource management as the 'city' manifests in time. In this section, we limit ourselves to the agricultural question insofar as Auroville's nutritional self-sustenance is concerned.

ii. *Food Security*

In terms of Mother's vision, a self-sustaining agricultural sector was imagined, capable of producing sufficient food for its own consumption with export of surplus and limited imports. True to the spiritual and ecological ethic, farming in the early years was emphasized not only to meet nutritional needs but also strengthen a collective consciousness through work. The focus was on cultivating chemical-free, organic produce with a greater awareness of the connection between the consumer and their surrounding environment from where their food came.

Outside the walls, in my first formation there was on one side the industrial estate, and on the other the fields, farms, etc., that were to supply the city. [in relation to the 'ideal formation' of 1938, a precursor to Auroville]

You see, we had planned a lot of lands around the city for largescale agriculture for the city's consumption. But to cultivate those lands, for the moment we need money, or else materials.⁹⁷⁴

This concern with food security has been a persistent pressure point for Auroville, particularly post 2000 with a rapidly changing land use in the neighbouring regions of Pondicherry and Edayanchavadi, driven by urbanization patterns, speculative development and a generational

⁹⁷⁴ Guigan, 2018, Vol. 1, 30-1.

shift from agricultural to other work in the villages.⁹⁷⁵ Already in the late 19880s and early 1990s, concerns with low agricultural yield were voiced:

The development of the Green Belt and of farming has also been subjects of major concern. Yet, and this probably relates to the urban background of many Aurovilians, farmers on some 14 farms never formed the cornerstone of Auroville's economy. Rather, it is forestry, botanical gardens and ecology for which Auroville has become well-known.⁹⁷⁶

Responding to this concern, early moves were made to organize and streamline production to meet community demands while preserving the ecological environment within a financially viable structure. The Farm Group was thus formed in 1994 to ground an agricultural strategy sensitive to the economic, cultural and environmental imperatives, serving as a representative body of all Auroville farmers in the community. Alongside, with farming classified as a 'service' sector, modest resources from the Central Fund (City Services) became available. In time, its mandate expanded as a strategic planning unit to estimate community demand, increase production and quality of produce, forecast resource needs (human and financial) and establish partnerships with governmental, non-governmental and private agencies in the sector. In general, the focus on estimating and building demand for organically produced, home-grown food in Auroville had to be met with interventions to strengthen the supply side. Outreach emerged as a critical step to dispel notions of farming being a 'menial profession' and build respect and passion towards the service in Auroville and its bio-region. Therefore, research in and promotion of sustainable agriculture practices, farming education through integration of practice in Auroville schools and developing a volunteering network were prioritized to increase hands on the field. Along with building and planning for farm labour, another intervention needed to integrate demand with supply was to create a structured platform for distributing Auroville's farm produce in a manner that safeguards its collective, community-led spirit. Food-Link was thus founded in 2008, with an addition centre near PTDC later, with the objective of providing a collective market for Auroville farmers wherein produce from Auroville's farms and forests could be collected and distributed to buyers including residents and other distribution centres within Auroville such as restaurants, community kitchens, Pour Tous outlets, PTDC and so on. In the spirit of community supported agriculture, Food Link serves as a participatory platform for farmers for distribution of produce but also – in the ideal – for strategic planning in terms of determining an efficient crop-planning system for Auroville's farms, in tune with the food requirements of the community. This strategy mitigated market pressures to some extent, yet the insufficiency of local demand and the opportunity cost of premiums for organic produce to strengthen the financial viability of the sector continue to raise concerns. Accordingly, there has been work, with varying emphasis, on designing

⁹⁷⁵ Kalra et. al., 2012, 25 ('A significant portion of area under cultivation in the region is rapidly being converted into non-agricultural uses. In Puducherry alone, it is predicted that in another two decades most of its territory will be urban with no agriculture left. Also, the productivity of the current agricultural land in the region is poor owing to unsustainable practices, lack of sufficient infrastructure and loss of agricultural labourers. The challenge is to protect the agricultural land base and to encourage its active use for food production.');

Evangelista et. al., 2018, 42 note that 'one Auroville planner also went as far as saying that farming is not viable at all within the Green Belt. However, it is important to note that this view was uncommon among interview participants.' Addressing this perception is a serious and urgent matter, if shared by others.

⁹⁷⁶ Thomas and Thomas, 2013, 90.

outreach and educational programs to instil a culture of consuming local, indigenous vegetables and fruits and to shift away from produce foreign to the region that tend to be in higher demand (e.g., tomatoes, lettuce, potatoes etc.)

True to the ideal, Auroville farms are largely organic, with a focus on bio-diverse, regenerative agriculture – mixed crop organic farming techniques are followed along with experiments in integrating traditional farming with modern techniques, with a view to promote ecologically oriented practices including natural farming, bio-dynamic farming, permaculture, vermiculture and others. In terms of the secondary sector, the footprint is limited, yet a few farms also undertake supplementary activities such as running food processing units (producing cheeses, chocolates, jams etc.), bakeries and community kitchens with ingredients sourced from farm produce.

As of today, Auroville has 21 farms spread over 342 acres of land, with 35-50 farmer-stewards, employing around 200 full time workers from surrounding villages. Annapurna farm accounts for 40% of the area under cultivation, with three farms (including Auroorchard and Aurogreen) accounting for 60% of all land. The farms differ in character, focusing largely on the production of rice (9%), fruits (40%), vegetables (6%), millets (5%) and legumes, along with dairy and poultry. Auro-Orchard, Auroville's oldest farm, is the largest producer of eggs for the community along with Alipsa farms. In terms of paddy cultivation, brown rice, red rice, 'chinna ponni', 'poovan samba', 'Co43', 'sona malli', 'sona mahsuri' and a variant of basmati are grown by Annapurna Farm, Ayyarpadi, Sidhartha, Kottakarai and Solitude. In terms of fruit cultivation, Auro-orchard, Brihaspati, Solitude, Kottakarai, Aurogreen, Siddhartha, Pazhamudir Cholai, Terrasoul and Annapurna Farms grow papaya, avocado, banana, chikoo, coconut, dragonfruit, jackfruit, guava, grapefruit, mango, citrus fruits, pomello, sweet lime, kumquat, passion fruit, pineapple, star fruit, sitaphal, ramphal, tangerine, watermelon and sweet melon. In terms of millets and legumes, Ayyarpady, Siddhartha, Annapurna, Kottakarai and Kalpavruksha produce different varieties of millets such as *ragi*, *varagu*, *tennai* and *samai* and leguminous crops like corn, urad dal, mung beans, karamani, sesame and peanuts. For vegetables, farms grow pumpkin, okra, cucumber, beans, yam, sweet corn, gourds, eggplant, spinach, chilly, basil and mint, with a range of seasonals, tomatoes, carrots, beetroot, rucola, capsicum, cauliflower, cabbage, coriander, tapioca, jicama, sweet potato, garlic, drumstick and celery. As we discuss below, yield, under-utilization of land, scale and market linkages continue to remain concerns.

Detailed farm/crop-wise data on planting / yield and demand is not available, yet food security, in grains and fruits and vegetables, is a concern. At present, Auroville farms meet about 15-20% of the local demand in the peak season when the weather is cooler (between December-March), and in the summer months (between March-December), the production drops down further to meet 5% of demand. Production is guesstimated to require an increase by a factor of 15 for the existing population, both in terms of augmentation of existing yields and increasing

land under cultivation.⁹⁷⁷ A marked increase in soil fertility notwithstanding, acute water shortage for agricultural irrigation poses serious concerns:

Farmers will be severely affected in the absence of suitable irrigation water to meet their requirements creating a looming catastrophe with very wide implication on the political and social stability of the entire region ...

A wind-powered desalination plant has been suggested. Unfortunately, this does not address the larger issue of irrigation water which is essential for agriculture in this region. Farmers in Auroville have noted that water for irrigation is a matter of serious mid-term and long-term concern. They have developed and implemented many water saving technologies, and have successfully demonstrated that crops can be profitably grown with far less water than is currently the practice in the wider Bioregion. However, continued over-pumping elsewhere in the aquifer puts the entire region at risk for the loss of both domestic and agricultural supplies, and needs to be addressed urgently. A proposal has been made to study the potential for greater surface water storage in a large tank/reservoir that would be constructed as part of the Matrimandir. This would form part of the domestic water system. However, it would most likely require a new source of water since drainage flow is away from this point ... Farmers in Auroville have noted that water for irrigation is a matter of serious mid-term and long term concern. They have developed and implemented many water saving technologies, and have successfully demonstrated that crops can be profitably grown with far less water than is currently the practice in the wider Bioregion. However, continued over-pumping elsewhere in the aquifer put the entire region at risk for the loss of both domestic and agricultural supplies, and needs to be addressed urgently.⁹⁷⁸

Records indicate that aquaculture options (including for paddy cultivation) offer potential, though there is some uncertainty on whether this is currently under consideration. In general, examining forest food production options for fruits and vegetables, whilst maintaining the biodiversity of existing forests, seems to be an under-explored avenue. Revi's 2006 remarks seem to also hold true today:

The massive standing biomass in and around Auroville is one of its least leveraged assets', which would need to be mapped and quantified and linked to cycles of growth, regeneration and succession to develop an appropriate long-range 'management plan' in consonance with 'city' development needs.

...

Examining the food footprint of the city will be an important precursor to a more detailed sustainability analysis for the 'city' and its bioregion. It will be necessary to expand the area and volume of food production in Auroville and also examine the potential footprint of the growing floating population. If even a moderate degree of food security is not able to develop within Auroville, the pressure on trade of other products and services will rise significantly, and strict form sustainability becomes only a paper goal.⁹⁷⁹

⁹⁷⁷ Total production of vegetables, fruits and grains in 2016-17 was 57,346, 37,922 and 34,933 kgs, in 18-19 was 46,929, 45,613 and 25,328 and 2019-20 was 39,53, 41,219 and 20,775.

⁹⁷⁸ Stein and Stein, 2019, 21, 29.

⁹⁷⁹ Revi, 2007, 5.

Labour availability is another concern – with reportedly high migration in the bio-region and shift in cultural attitudes away from manual work, the farming sector seems to currently rely heavily on approximately 50-55 stewards and a network of temporary short to mid-term volunteers. Alongside, demand-side interventions for consumption habits, currently skewed towards imported produce are needed, though consumption data for Auroville and the bio-region is unavailable. Investment in the farming sector also seems limited, with low figures of 58, 59, 66 and 93 lakhs per year in the period from 2019-20 to 2022-23, respectively at approximately 3-4% of the City Services Fund, with external donations for the ecology sector hovering between 0.5-3 crores, largely for forestry and related research activities.

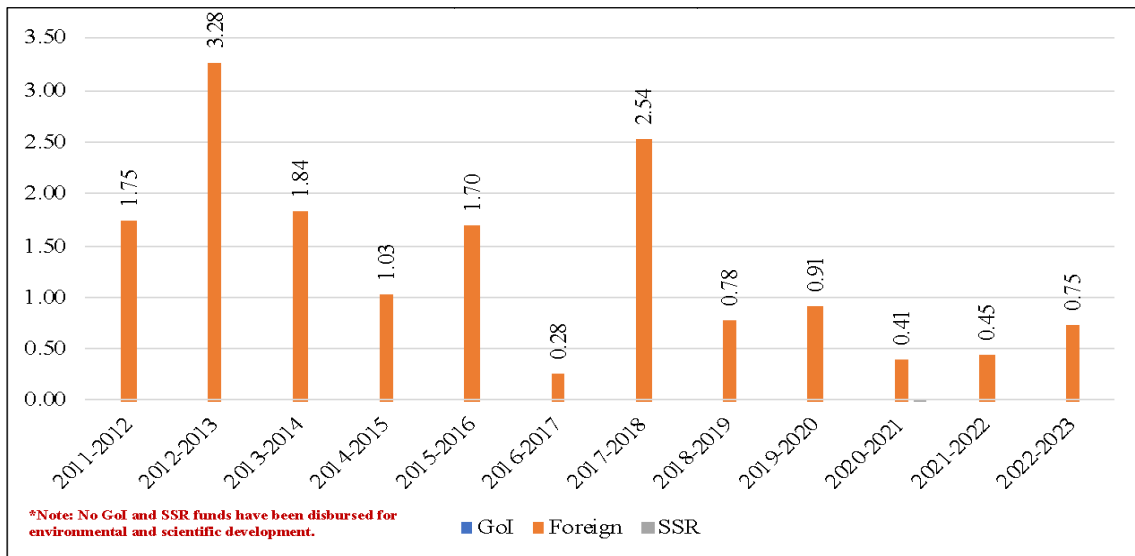

(Environment-track external donations and grants, 2011-23. Source: Unity Fund)

iii. Green Belt Planning Framework

The Green Belt planning framework is comprised in the Masterplan and the 2013 Green Belt Development Plan and Land Use Plan by Stein and Stein.⁹⁸⁰ The 2019 Green Belt Growth Management Framework Study also offers important insights. As such, given detailed and recent work in the area, we do not rehearse known facts and keep our review brief to identify persistent points of tension and development priorities.

In 2000, at the time of the Masterplan, there were 990 hectares of land marked for agriculture, 57% of the unbuilt area, though much of it vacant or marginally used.⁹⁸¹ The Masterplan proposed to use the western part of the Green Belt covering 500 acres for intensive agricultural development. The objective was as follows:

They will be utilised to set up prototype farms for raising appropriate crop varieties that can be efficiently produced in differing geographic conditions in Tamil Nadu, in order to replicate them for the benefit of farmers in these areas. The geographic regions will correspond to the five-fold traditional regional classification in Tamil Nadu of Kurinji, Mullai, Marudam, Neithal and Palai. Auroville’s ongoing work in

⁹⁸⁰ Stein and Stein, 2013, 2015.

⁹⁸¹ Masterplan, 2001, para. 1.5.1.

water management, soil conservation, organic farming and seed collection, which is being carried out in collaboration with state, national and international research institutions and agencies, will promote food security and optimise the agro-economic potential both locally and nationally.⁹⁸²

Developments in the Green Belt from 2000-2013 occurred outside a planning framework. With growing concerns of food security, water management and non-harmonious land use by developers in the region, the TDC commissioned the Stein and Stein Green Belt Development Plan, 2013 and Land Use Plan, 2015 to chart a systematic and sustainable pathway forward. The Land Use Plan notes:

Thanks to the recent rapid growth of Puducherry and the rise in incomes throughout India, there has been growing pressure to develop around Pondicherry including the Auroville area, and land prices have risen to astronomical values. A number of sites within the Green Belt have been purchased by outside developers using the attraction of Auroville to entice new owners to purchase 'farms' within gated communities along the main roads leading into Auroville. This form of development is contrary to the spirit of Auroville.⁹⁸³

With the continued threat of encroachment from sprawling urban development working its way north from Pondicherry along the East Coast Road, Auroville has come to the realization that it needs to understand the situation better and to reassess its original plan for the Green Belt in order to realistically plan for its protection.⁹⁸⁴

The Green Belt Development Plan notes that the soil and topography of the bioregion are suited to agriculture, yet challenges remain as 'what is consumed substantially exceeds the amount that can be grown on available acreage with the limited human resources available.'⁹⁸⁵ The Plan summarizes the agricultural situation as of 2013, and valid today:

Maintaining organic certification is complicated by the use of non-organic methods and inputs by other farms located within the Green Belt. Despite climatic and economically challenging conditions, Auroville has continued to experiment with ecological agriculture that favors natural inputs and genetic diversity.

The variability of the monsoons has resulted in periodic crop failures, while the lower market prices of non-organic foods and the subsidization of conventional farming put Auroville-grown produce at a disadvantage.

Farms in Auroville continue to experiment with various methods, such as bio-dynamics, permaculture, earth bodies, vermiculture, inter-planting and cover cropping with nitrogen-fixing leguminous plants (both indigenous and exotic), and the use of effective micro-organisms. These methods are combined with eco-friendly use of water and electricity, involving windmills, solar panels, rainwater harvesting and drip/sprinkler irrigation systems. In addition to cultivating the land, farmers are continually testing new methods in agro-ecosystems, agro-forestry, green manures, mulch farming and the use of intercropping.

⁹⁸² Masterplan, 2001, para. 2.5.8.

⁹⁸³ Green Belt Land Use Plan, 2015, 7.

⁹⁸⁴ Stein and Stein, 2013, 6.

⁹⁸⁵ Stein and Stein, 2013, 33.

Currently Auroville is self-sufficient in milk and some seasonal fruits. About half of Auroville's total needs for fruits and vegetables are produced internally, while rice and grain farming supply a relatively modest 2% of the total demand.⁹⁸⁶

The Development and Land Use Plan offer a policy and zoning framework for the Green Belt, with agricultural land use concentrated in the western half.

⁹⁸⁶ Stein and Stein, 2013, 33-4.

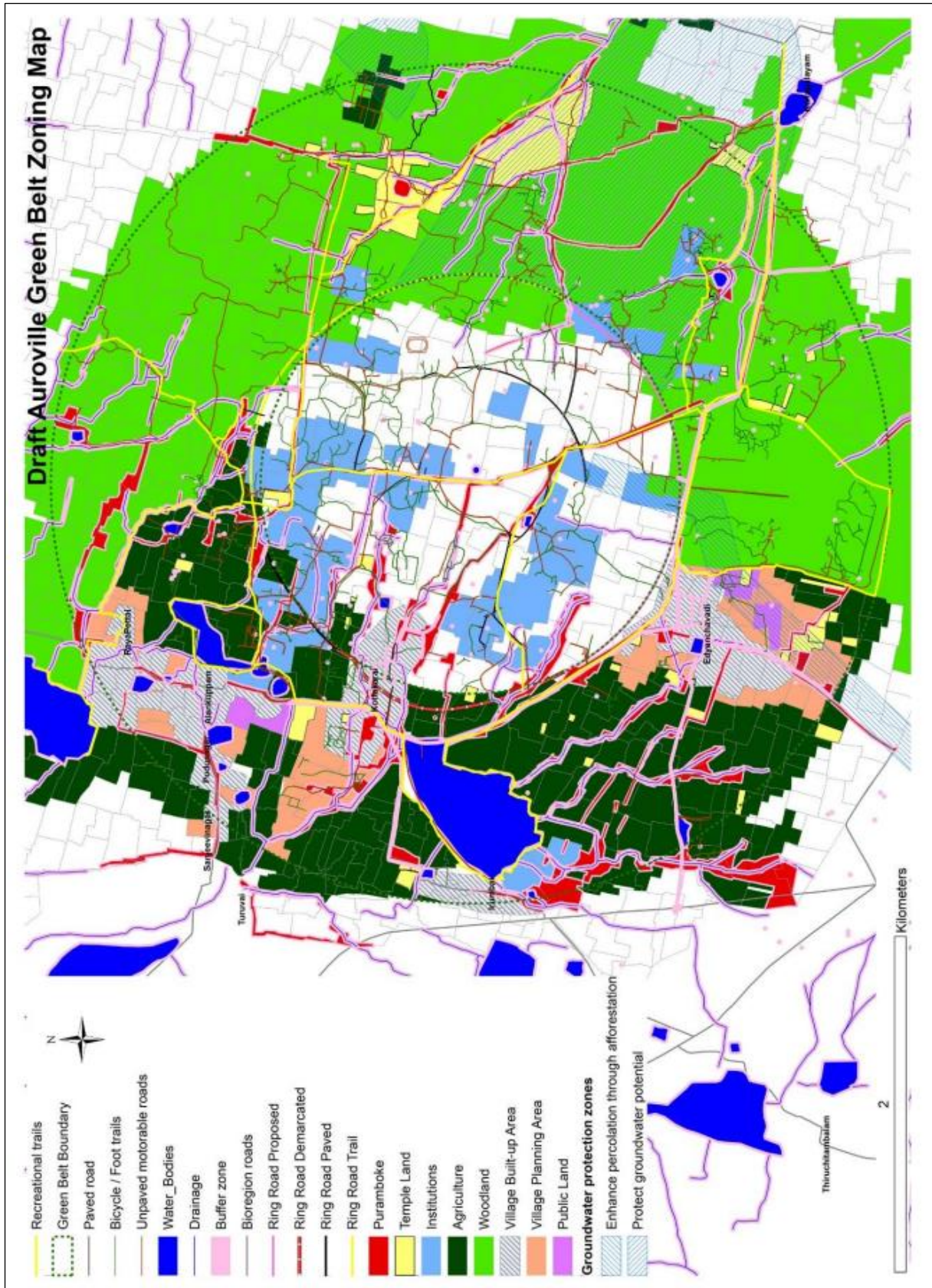

(Green Belt Zoning Map. Source: Stein and Stein, 2016, 14)

iv. Current Status

The Green Belt Development and Land Use Plans are yet to be approved and implemented by the TDC, reportedly owing to concerns with ‘enforcement of [its] prescriptions’ / ‘Green Group attitudes.’⁹⁸⁷ Governance concerns with sub-optimal utilization of lands and reluctance to coordinated planning for land use / crop distribution changes are indicated in the records. These were sought to be addressed in 2011 by a FAMC-appointed Steering Group, working with the Farm Group, to develop a 5-year Agricultural Plan:

As part of the five year Sustainable Agriculture Plan for Auroville, the vision and mission of the Farm Group was defined as follows: Vision • To create and maintain a healthy and conscious farming system, integrated with and providing food for Auroville. • To produce food in a way that is sustainable for the earth, the community and the bioregion. • To promote and advance sustainable farming practices locally and globally. Mission • To provide as much healthy, organic food for Auroville as possible. By providing one of the basic needs of the community, Auroville’s agricultural sector will be a major contributor to making Auroville a self-supporting township. • Establish and maintain a community-embraced network that guides and supports food production and distribution for Auroville. Information systems will enable the farms to estimate demand, monitor production, and set targets for production of selected items. • Create certification and monitoring systems which will ensure high quality organic produce and promote the sharing of best practices amongst farmers. • Provide education and experience, Increase knowledge, awareness and practice of sustainable organic farming in Auroville and beyond. The above Vision and Mission were accepted by all members of the Farm Group, each of whom endeavours to manifest this in her/his unique way in day-to-day farming activities.⁹⁸⁸

To the best of our understanding, this plan went into abeyance, and as of today, an agricultural plan is yet to be put in place. The concerns required to be addressed remain: (i) growth, yield enhancement / scaling, crop distribution and water and energy use strategies, particularly for foodgrains, with soil profiling and suitability analysis and prior investment in anticipation of future population projections, (ii) internal and regional food and nutritional security futures planning, (iii) market linkages and geo-marker / brand development, (iv) scaling and management strategies for human resource, newcomers and local labour, tapping into the network of women and men-led SHGs in the bio-region to promote farming and farm-based businesses, (v) resource mobilization plan,⁹⁸⁹ (vi) a bio-regional agricultural plan, including water management strategies, organic certification strategy and support,⁹⁹⁰ (vii) livestock

⁹⁸⁷ TDC Annual Development Plan, 2014-15, 18; Full Report, Auroville Retreat, 2015, 49.

⁹⁸⁸ Auroville Foundation Annual Report, 2011-12, 14.

⁹⁸⁹ This is a significant concern. In 2016-17, the Farm Group noted: ‘... as always the Farm group is faced with many financial challenges with a number of farms having some very acute investment needs for essentials like a well or fencing. At the moment there are no investment funds available and most of the infrastructure development has been with loans rather than grants.’ It reiterated this concern in 2019-20: ‘Lack of investment in farms – the farms continue to struggle to find enough money for basic infrastructure such as fencing and wells. This is particularly acute when it comes to setting up new farms.’ Auroville Foundation Annual Report, 2016-17, 14-15; Auroville Foundation Annual Report, 2019-20, 17.

⁹⁹⁰ In a significant move, in 2019-20, 10 farms collectively agreed to get organic certification, through the Tamil Nadu Agriculture University to enhance the relationship with the Tamil Nadu State Agriculture Department.

requirements and management strategy (vii) development of food processing and secondary value addition units,⁹⁹¹ (viii) optimizing harvesting and storage practices (ix) ‘forest food’ production strategy, (x) aquaculture options, (xi) institution and capacity building in terms of training, education and agricultural college / model farms / agricultural parks and (xi) legal strategies to address conversion of land use away from agriculture to urban uses, both in the Green Belt and the bio-region.

Alongside, policy and on-ground work in the following areas remain to be explored for future planning: (i) collaborative agricultural models with privately owned lands in the Green Belt and those in the broad bio-region, through peppercorn leasing, transferrable development rights, ‘Goodwill Zones’ / ‘Collaboration Hubs’, customary usufruct options; (ii) developing premium organic market linkages and supply side infrastructure development for export; (iii) community-supported agricultural models tied to neighbourhoods, restaurants, food chains with programmes for dietary changes; (iv) verifying and filling gaps in geospatial data; (v) bio-region interventions for phone-based agricultural market intelligence; (vi) strengthening village and regional linkages, through the Village Development Committees, Regional Planning Authority and State Planning Commission, for a regional agricultural plan that includes Auroville, including educational and social interventions to address shift in cultural attitudes,⁹⁹² and (vii) expanding FoodLink.

v. *Development Priorities*

Based on this short overview, the following development priorities emerge:

a. *Plans, Studies and Surveys*

- i. Formalize the 2013 Green Belt Development Plan and 2014 Green Belt Land Use Plan.
- ii. Review and formalize 2017 Water Management Strategy and 2013 Water Sourcing Study.

Auroville Foundation Annual Report, 2019-20, 17. It was proposed in 2011-12 ‘to set up a peer group to monitor certification and all farmers will be expected to adhere to its. In the future, and especially if food is sold outside Auroville, this process could itself be certified by a body like IMHO.’ It appears that this proposal was not taken forward. Auroville Foundation Annual Report, 2011-12, 15. As of 2018, Evangelista et. al., 2018, 42 note in relation to village lands that ‘there is no market for organic produce other than the small market provided by Auroville ... meaning that organic produce does not receive a premium over similar conventionally farmed produce. The Auroville Farming specialist said that the organic certification process would require a large investment for farmers and pose a big risk for their already small profit margins, and this deters villagers from engaging in these practices.’ Investment in developing certification, supply chains and branding are thus necessary to promote organic farming among privately owned lands, given disincentives. Some work was also recorded on this front by the Sustainable Livelihoods Institute, in 2016, with a workshop on organic farming practices to the Association for Sarva Seva Farm; in 2019, with short introductory programmes for the local community in regenerative farming practices and the Seed Festival hosted by the AVAG, attended by more than 2000 participants. Auroville Foundation Annual Report, 2016-17, 29; 2019-20, 38-9.

⁹⁹¹ In 2019-20, the production of processed food items was limited at Rs. 56.55 lakhs.

⁹⁹² The 2008 Villupuram District Agricultural Plan (currently in place) lists this as a priority action point, with budget outlays. See, Villupuram District Agricultural Plan, 2008, 67. See, JPAL, 2021 on the need for strategic thinking on how incentives may need to be developed regionally.

- iii. Revisit and update the 2011 Strategic Agriculture Plan. To that end, conduct a food security audit to understand existing consumption patterns, food and biomass demand future projects, leading to a food and nutrition security plan, with scaling strategies; examine current land utilization / cropping patterns, for efficient sector-wide redistribution or consolidation of lands; explore farm management software solutions.
- iv. Studies to be conducted: regional food and nutritional security futures; carbon sequestration potential in farming; future studies on ecological / agricultural technology (smart-crop monitoring, drone farming, appropriate autonomous-machinery application), including areas identified in NEP, 2020.

b. Data Collection and Technology Integration

- i. Institute data collection practices to measure yield, examine cropping patterns/land utilization with GIS integration for efficient sector-wide redistribution or consolidation of lands, track consumption patterns and export / import of produce.
- ii. Data gathering tasks, identified in Revi, 2006: establish digital weather tracking systems, and metrological, weather profile, time series GIS databases; conduct lithological, soil profiling with GIS integration; conduct crop and land suitability (productivity estimates, species profiling) analysis with GIS integration; conduct water resource profiling (ground, surface water, desalinization feasibility study; geohydrological modelling).
- iii. Explore end-to-end farm management software solutions from crop life cycle management and planning (soil and water testing, weather tracking etc.), livestock development, inventory management, market rates tracking, analytics and processing to distribution. Explore farm management software, such as Farm ERP, Krisol ERP etc.

c. Development Strategies

- i. Plan for an agricultural special economic zone (examine ‘eco-park’ funding options in the NEP, 2020), extension centres for market intelligence, phone-based agricultural information delivery services, market infrastructure development and price surveillance such as through e-NAM utilization, full utilization of National Agricultural Development Programme funds, veterinary clinic and integrated organic dairy and livestock development.
- ii. Examine industry-linkages with agri-tech / food-tech sector.
- iii. Explore ‘forest food’ production strategy; explore aquaculture options; integrate urban agriculture options into Zonal Development Plans.

- iv. Explore bio-fertilizer / soil conditioner manufacture and distribution potential.⁹⁹³
- v. Evaluation of food processing and value addition models, with local employment, skilling projections; supply chain development for export, with Auroville / bio-region geo-markers and market strategy development, including e-commerce; investment in common secondary production, crop treatment, retail facilities for value-add.
- vi. Examine feasibility of consolidation of small land holding farmer collectives in the region, with processing, packaging and distribution services through market linkages and provision of crop monitoring technology, end-to-end supply chain software for efficient market linkages, on-call agri-expert advisory team, certification support and storage facilities.⁹⁹⁴
- vii. Explore strategies for horticulture and sustainable livestock and dairy sector development. Consider pathways for an integration of agricultural development from crop production and sale, food processing to other value-added activities like livestock rearing and agro-education, to develop an ecosystem of agriculture services.
- viii. Establish ‘Goodwill Zones’ with villages in the Green Belt for knowledge sharing, credit extension.⁹⁹⁵
- ix. Identify privately owned lands in the Green Belt for ‘peppercorn’ leasing; explore transferrable development rights, customary usufruct options.
- x. Develop / expand models of community-supported agriculture through FoodLink centres; collection of consumption data, developing price / in-kind metrics; supporting programmes with restaurants, food chains, schools, wholesalers etc. for gradual shift in dietary habits to local crops.⁹⁹⁶

⁹⁹³ Eco Pro currently produces biochar and biocharbased Terra Preta compost and distributes it to Auroville farms interested in their usage. Auroville Foundation Annual Report, 2018-19, 23. Developing *in situ* capacity will be valuable.

⁹⁹⁴ See, as an example, Sahayadri Farms, Nashik, Maharashtra.

⁹⁹⁵ Directions for Growth, 2003, 19-20. The Goodwill Zone proposal comes a 2003 paper by Chandresh Patel. This is key, as we discuss in Part III.G (‘the concept propounded for Goodwill Zones ... is eminently suitable not only for building enduring links with the surrounding communities and securing the lands in the Green Belt from inconsistent use, but also for building up a strong agro-sustainable economy for Auroville, as well as the people from the villages within the Auroville township area.’)

⁹⁹⁶ An edited volume was produced along these lines in 2015, ‘From Local Farms to Auroville Plate – A Collection of Traditional Recipes’ by the Life Education Centre. Auroville Foundation Annual Report, 2015-16, 17. In 2019-20, the Farm Group notably proposed ‘an educational space for cooks and chefs to showcase how to use local crops.’ We were unable to ascertain the status of this proposal. See, Auroville Foundation Annual Report, 2019-20, 17.

d. Governance, Finance and Outreach

- i. Strengthen accountability structures as against the Green Belt Development Plan and food / agricultural security plan through utilization metrics, monitoring and impact evaluations by the Green Group, with review by the proposed Unity Committee; build support and consensus with the Forest and Farm Groups to address identified tensions in the TDC Annual Development Plan, 2014-15.
- ii. Promote bio-regional engagement in Villupuram under the District Agricultural Plan, 2008; engage with the Tamil Nadu State Planning Commission for collaborative planning in Villupuram district, in relation to proposals for agri-oriented infrastructure (cold-storage plants, godowns, market yards and threshing floors), an agricultural special economic zone, extension centres for market intelligence, phone-based agricultural information delivery services, market infrastructure development and price surveillance, e-NAM utilization, organizing exposure visits to Auroville and other organic farms, full utilization of National Agricultural Development Programme funds, veterinary clinic and integrated organic dairy and livestock development.⁹⁹⁷
- iii. Develop a resource mobilization plan, including research-linked funding, inventory of state schemes / ICAR funding options, ESG-linked CSR.
- iv. Strengthen integrated training / consultancy services.⁹⁹⁸
- v. Evaluation of food processing and value addition models, with local employment, skilling projections; supply chain development for export, with Auroville / bio-region geo-markers and market strategy development, including e-commerce; investment in common secondary production, crop treatment, retail facilities for value-add.
- vi. Consider centres / college for agricultural training / ‘farmers field’ / demonstration plots to capture and leverage the existing knowledge base in organic farming, thus attracting those aligned; examine regional linkages with agricultural universities (including the Tamil Nadu Agriculture University, with which links were established in 2019-20), ICAR centres; encourage peer-reviewed research to document Auroville’s environmental intervention, development of farming manuals and documentation of traditional farming techniques.
- vii. Examine agricultural education reforms in the National Education Policy, 2020, including agricultural technology research infrastructure.

⁹⁹⁷ Evangelista et. al., 2018 note that ‘village resource persons also mentioned that farmers could use support from Auroville to better connect them to government assistance for agriculture.’

⁹⁹⁸ Significant work has been recorded here by the Botanical Gardens, Pitchandikulam and Sadhana Forest. *See*, Auroville Foundation Annual Report, 2016-17, 16. Auroville Foundation Annual Report, 2020-21, 22. Strengthening these works with regional alliances, developing capacity for greater outreach, integrating services through collaborations others Auroville units in the green space, in renewables, energy, sustainable building etc. can allow for greater reach and generate revenue to support research activity in the sector.

- viii. Examine certificate and extension course collaboration with Bangalore Regional Centre for Organic Farming, Department of Agriculture and Natural Farming, Central Government.
- ix. Build linkages with the Organic Farming Association of India / Organic World Congress, with in-residence apprenticeships to attract newcomers; develop conference / demonstration network.
- x. Consider credit extension schemes for newcomer housing on agricultural plots.
- xi. Support for organic certification and premium branding, supply chain management for Auroville and village farms. Revisit the 2011 proposal for an internal peer-group certification / Auroville Organic Certification / collaboration with IMO Control India.
- xii. Strengthen AVAG's work with millet cultivators to establish linkages with government and non-governmental organisations that support farmers in the production, marketing and value addition to millets;⁹⁹⁹ annualize the SLI / AVAG Seed Festival.
- xiii. Integration of Green Belt in Auroville and outreach schooling curricula, with embedded learning / apprenticeship / internship / externship opportunities.
- xiv. Encourage entrepreneurship in the food sector through setting up 'risk funds' to support new initiatives; capital infusion through banking credit; establishing a culinary institute, suggested in ISP, 2013.

*

⁹⁹⁹ See, Auroville Foundation Annual Report, 2020-21, 21.

PART IV
GOVERNANCE REFORM

*They call in Truth for their high government,
Hold her incarnate in their daily acts
And fill their thoughts with her inspired voice
And shape their lives into her breathing form ...*

Sri Aurobindo, *Savitri*

Everything begins in mysticism and ends in politics.

Charles Péguy

In this part, we consider Sri Aurobindo and Mother's spiritual and urban scheme outlined in Parts I and II as against the empirical reality of Auroville's governance practices reviewed in Part III. **Section A** maps Auroville's growth trajectory to Sri Aurobindo's *The Ideal of Human Unity, Human Cycle* and Mother's four powers, placing today's challenges in context. **Section B** suggests reforms in the Residents' Assembly for a representative and confederated bicameralism, with the introduction of zonal and sub-zonal assemblies, to bring it closer to the ideal an accountable, efficient and 'more democratic democracy.' **Section C** suggests a reworking of the selection, operation and evaluation of Working Groups to (i) strengthen executive powers, (ii) select expert-led and expert-constituted bodies to align with the principle of 'illuminated hierarchies with collective discipline', (iii) develop a firm zonal and sub-zonal architecture to allow for vigorous, meaningful and accountable participation, and (iv) institute a Unity Committee and Steering Group for evaluation and monitoring. Summing up the first three sections, **Section D** proposes a template for institutional reform, with a brief outline of design principles. Lastly, **Section E** considers the limits of institutional reform vis-à-vis inner and cultural practices that alone can secure Auroville's political ideal, suggesting (i) the progressive yet not premature substitution of rule enforcement with 'spiritual compulsion', secured through an actively stewarded and cohesive public sphere, (ii) a more open and assimilative outlook to expertise and developments elsewhere, and (iii) proactive, sensitive and targeted outreach to incrementally increase population numbers, which may push the city forward to the ideal of a dynamic, concentrated and spiritual urbanism. Some suggestions in this part are of immediate import, while others are in anticipation of governance requirements for the future as numbers grow.

A. MAPPING GOVERNANCE FORMS

i. *Mapping the Evolution of Governance Forms*

In an exchange on April 13, 1968, Mother remarked that ‘no one has studied the problem on the level of administration or organisation’.¹ While there is a large body of literature detailing Auroville’s emergence and growth from its humble origins to where it stands today, with an equally sizeable literature on development plans and models, the question of appropriate governance forms remains understudied with some notable exceptions.² Particularly as Auroville stands at an inflection point and prepares for the next stage of its growth, it is valuable to enter this exercise to examine the historical trajectory and structure possibilities for the future.

While exemplary work has been recorded in some sectors, it is fair to say that Auroville is – as a city in the slow making – at a nascent stage of its governance journey, in terms of scale and complexity. Examining how one can organize collective processes – or, as one conversant perceptively put it, how one can ‘spiritualize institutions and not institutionalize spirituality’ – remains a fascinating and pressing question to consider. In this, Mother’s early remarks in the *Agenda*, read in the backdrop of Sri Aurobindo’s socio-political works, *The Human Cycle*, *Ideal of Human Unity*, *Bande Mataram* and *Karma Yogin*, provide the architecture, but not the furniture, for us to study Auroville’s governance future informed by its empirical context. Section III of this study provides a synoptic summary across seven sectors to understand the empirical, on-ground realities – our purpose here is not to rehearse known facts, but rather, to place the learnings from this overview as against the philosophical roadmap outlined in Parts I and II to map Auroville’s collective dynamics in the context of Mother and Sri Aurobindo’s socio-political evolutionary scheme.

This mapping may be done in many ways. We explore one pathway, to map Auroville’s growth trajectory to the stages of the Integral Yoga, translated into a socio-political or collective frame in *The Human Cycle* and *The Ideal of Human Unity*. These works may be seen as a detailed philosophical excavation of the bold and inviting proclamations of Mother’s Charter. Sri Aurobindo’s comprehensive mega-history articulation of the subtle and often hidden causes that drive a society’s evolution provide a helpful interpretive foil to understand the manifold, and often confusing, developments in Auroville.

In this, Sri Aurobindo’s thought centres on a graded psychological evolution along two axes. The first is from symbolic, to conventional and typical and finally subjective and spiritual modes of collective organization, with an intermediating, potent and necessary collective rational ordering, the ‘age of reason and individualism’. The second, which intersects with the first, is between the twin forces of centralization and decentralization, or collectivism and individualism. As each stage brings with it some characteristic advances and challenges, a broad-view thematization of each stage, even if caricatured, can provide a helpful perspective to understand the present moment in historical context and chart pathways forward. It is helpful

¹ Guigan, 2018, Vol. 1, 279.

² We have listed references in the bibliography, and will not repeat them here for the sake of brevity.

therefore to examine discussions on planning and organization in Auroville within the frame of this graded scheme, as – at least in the ideal – a ‘rapidly accelerated attempt to discover and work out the right principle and secure foundations of ... [an appropriate] system of society.’³

Needless to say, Auroville will have to tailor-make fit-to-purpose governance and institutional forms to embody its unique aspirations. In this, a meaningful dialogue with the literature, Sri Aurobindo and Mother’s works, and as also others in a long-standing tradition of socio-political thinking and urban governance aligned to their ideals, will be helpful. While Auroville’s current scale limits the complexity of its governance concerns, anticipating the future is necessary. Our discussion here is thus suggestive and speculative, rather than prescriptive or final, to consider the field of possibilities with recommendations and templates where appropriate. We offer a rough reflection that presents a rich area for further exploration, with both philosophical and practical import. We provide below three (over) simplified schematic representations of Auroville’s growth as against the conceptual architecture of Sri Aurobindo and Mother’s evolutionary scheme. In what follows, we expand on these to delineate the salient characteristics of each stage, with Sections B, C and D suggesting templates for reform in the Residents’ Assembly, Working Groups and zonal bodies along these lines.

³ Sri Aurobindo, CWSA, 1997, Vol. 25, 192 (inline addition ours).

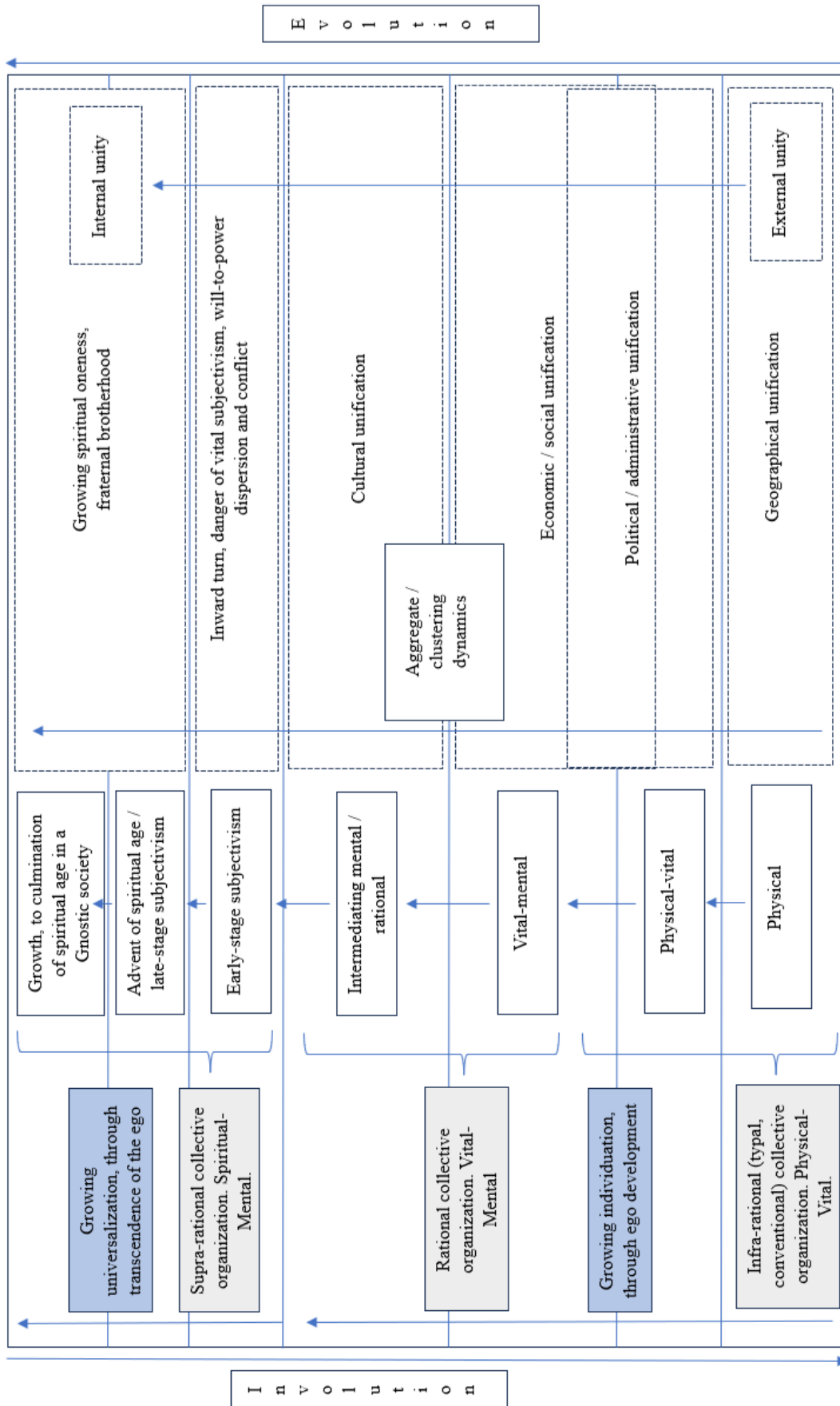

Simplified evolutionary scheme of socio-political aggregation. See, Part I.C



(Mapping Auroville)

ii. *Movement Upwards from the Physical to Spiritual: the 'Y' Axis*

We have discussed Sri Aurobindo's socio-political evolution scheme in Part I with a simplified schematic of movements of inner and collective growth. In *The Human Cycle*, Sri Aurobindo maps the stages of growth in the Integral Yoga – from the inconscient, vital, mental and supramental, with intermediate finely carved gradations within – to the six stages of collective growth – symbolic, typical, conventional (infra-rational), rational, subjective and spiritual stages – in the evolution of a society, employing the *sāṃkhya* theory of the three *gunas* or psychological modes to explain the regulative sentiments of each stage. Alongside, in *The Ideal of Human Unity*, Sri Aurobindo expounds the teleological orientation of this growth trajectory, from the perspective of geographical, political / administrative, economic, social / cultural and spiritual unity, as a story of the progressive passage from the external (physical) aggregation of a peoples to the internal (spiritual) oneness. While Sri Aurobindo addressed these questions at a grand scale, across nation states and the international political order of particular moment in the first part of the 20th century, the underlying pattern is equally applicable to smaller collectives like Auroville. It is thus interesting to ask how Auroville's growth maps on to this scheme.

a. *The Three Axes of Growth*

Placing Auroville within this conceptual frame, we can identify four broad stages in growth. The first stage of land purchase, with initial settlements, land reclamation and regeneration, which forms the physical base. The second stage of the development of housing, services and commercial units, which forms of the vital base. The third stage of organization, planning and consolidation, which forms the mental or rational base. And the fourth, or aspirational, stage of reaching to the spiritual ideal, preceded by an intermediate (and dangerous) phase of subjectivism tending to false, vital subjectivism.⁴ Alongside each stage in this axis (the 'y' axis), particularly as one proceeds in time up the scale, comes the twin play of individualism and collectivism, decentralization and centralization, that is the central dynamic of *The Ideal of Human Unity*, (the 'x' axis). Each tends in its extremes to concerns: the former – individualism / decentralization – tends to dispersion and conflict, due to assertive liberty-induced disharmony and scattered settlements, and the latter – collectivism / decentralization – tends to uniformity and cramping liberty on the other due to a levelling-down egalitarian attempts or stifling bureaucratization. The evolutionary enterprise here is to harmonize these extremes in a cohesive fraternity, a living unity in diversity, as the society moves through the 'y' axis. This is accomplished through two vehicles, inner and outer. On the inner level, this depends on the practice of the collective and individual yoga by residents, for an elevation of consciousness in the collective, the ineffable 'z' axis. On the outer level, this is facilitated by helpful institutional and formal governance forms at the 'central' level (Governing Board, Residents' Assembly and Working Groups) and the 'local' level (Zonal and sub-zonal groups, smaller organic collectives, neighbourhoods and wards in the Residential Zone, national

⁴ See, discussion and visual representation in Part I.

pavilions / groups in the International Zone, Cultural Zone research, educational, social and professional groups, Industrial Zone workplaces, offices, innovation / production clusters).

It would be incorrect to suggest that Auroville's growth started as a *tabula rasa* and proceeded strictly from one stage to the next. Yet, its development does exhibit distinct stages that can be mapped onto this classification, even if caricatured to some extent, to help understand the dynamics and respond to them with appropriate correctives in anticipation of the future path to be trod. Sri Aurobindo's scheme is neither linear nor a rigid classification that proceeds step-by-step in time, but a dynamic field of forces interacting with each, manifesting variously in different communities:

Obviously, such classifications are likely to err by rigidity and to substitute a mental straight line for the coils and zigzags of Nature. The psychology of man and his societies is too complex, too synthetical of many-sided and intermixed tendencies to satisfy any such rigorous and formal analysis.⁵

b. Evolution in Reverse

Crucially, there is an all-important, defining characteristic in Auroville that breaks the usual pattern of evolution: the Mother's early stewardship of the project, which infused a spiritual imperative and force into the foundations. Embodied in the construction and presence of the Matrimandir, Auroville's soul and centre, Mother's spiritual force animated all phases of Auroville's growth trajectory, from the first settlement of the lands in Aspiration and Auromodele to the varying dynamics of the slow and steady evolution since, including the substantial conflicts and challenges that have come in the process. The soul was built first, as a guiding and centripetal influence, with the body – physical, vital and mental aspects – to follow. A sort of evolution in reverse. Naturally, then, one would find the challenges that collectives usually face in the far end of the evolutionary journey, the end of 'the curve of reason',⁶ are the ones that Auroville began to face in the 1980s and 1990s. As the physical rehabilitation and greening of the land was substantially accomplished, space opening up for vital development in housing, economy and services and rational development in terms of planning, coordination, organization and research.

The spiritual impulse found, in a sense, a natural home in Auroville in the early years in the ecological ethic of the time. As the popular cross-currents between the 'East' and the 'West' inspired a search for liberating, if at times odd, forms of life amongst the youth, the return to the land, naked and enlivening, became a living symbol of a return to the spirit, free and clear. The first wave of green works offered the unbridled promise of adventure, space and freedom inspired by the barren and challenging landscape. Faced with a *terra nullius* for all practical purposes, a clean break from the past – and the economic rationalism of the present – seemed possible. A grand rejection, with the hope of a new future, one that was not bound neither by social convention nor the machinations of government. Records and autobiographical works of

⁵ Sri Aurobindo, CWSA, 1997, Vol. 25, 6.

⁶ See, Part I.

the time record in full measure the rich sense of promise and vitality, of the ‘great adventure, ‘something new’, the ‘Great Sense’.⁷

The innocent optimism of the times gravitated towards Auroville, held by a patient, loving and powerful anchor, the Mother. Even if yet vaguely articulated, the hope, freshness and ardour of the moment sustained the inspiration and drive to settle the lands. The social dynamics of counter-culture, anti-authoritarian movements of the time, which played no insubstantial part in the initial migrations, dovetailed well with this ecological imperative and the decentralized, ‘anarchist’ possibilities that lay in the remote reaches of Pondicherry, yet a quiet town. In a passage that uncannily describes the early motivations, Sri Aurobindo notes:

... now that the ubiquitous tentacles of modern society take hold everywhere; soon there will be no place of refuge left for either the nomad or the solitary, not even perhaps Saharan deserts or the secure remotenesses of the Himalayas ... [this] creates the nomad, the adventurer, the ranger of wilds ... because society, once an instrument, has become a prison and a burden, an oppressive cramping of his expansion, a denial of breathing-space and elbow-room.⁸

c. An Early Subjectivism

Yet, as the history of those movements amply demonstrates, the integration of that impulse – of rejecting the ordinary conventions, social, religious, economic and otherwise – with the challenge of creating enlivening and flourishing and yet ordered, efficient and productive collectives almost inevitably comes up against serious, and in many cases, fatal challenges. The ‘free’ and ‘liberative’ energies turn weary, after an initial period of enthusiasm, as material and organizational challenges present themselves in due course. The initial flourish is backed by a liberating rejection, yet absent an ordered and disciplined inner evolution, it risks dissipation. As we noted in Part I, the ‘anarchist’ leanings of the early years of Auroville came in many ways as a reaction to the organized, efficient illiberties of the time to which the youth movements of the 70s and 80s were a reaction. The ideal of a fraternal, unregulated and free society carried great force, with Auroville as the magnet for these aspirations:

To ensure coordination and prevent clash and conflict in this constant contact another power is needed than the enlightened intellect. Anarchistic thought finds this power in a natural human sympathy which, if it is given free play under the right conditions, can be relied upon to ensure natural cooperation: the appeal is to what the American poet calls the love of comrades, to the principle of fraternity, the third and most neglected term of the famous revolutionary formula. A free equality founded upon spontaneous cooperation, not on governmental force and social compulsion, is the highest anarchistic ideal.⁹

The ‘anarchist’ aspirations, to freedom, spontaneity and most importantly, a rejection of external authority, yielded naturally to experimentation. Placing this in Sri Aurobindo’s scheme of things, the move was from the ‘objective’, ‘mechanistic’ view of life to the ‘subjective’ one

⁷ See, Satprem, 1969, Majumdar, 2017, Anger, ‘=1’, 1968; Lohmann, 1972; Ciconesi and Ciconesi, 2012; Aggarwal, 2011.

⁸ Sri Aurobindo, CWSA, 1997, Vol. 25, 160.

⁹ Sri Aurobindo, CWSA, 1997, Vol. 25, 218.

– from false to the true individuality, at the ‘end of the curve of reason’. Yet, this is a razor-sharp shift and what *follows* is defining: *either* a dangerous vital subjectivism, driven by an impotent sentimentalism in its weak forms or a desire-driven will-to-power in its strong forms, which replaces the cramping effects of social regulation with unregulated license, *or* a push to spiritual discipline to build a solid, innovative and fraternal foundation. A movement upwards or downwards.

This shift, Sri Aurobindo noted, was ‘the characteristic turn which modern civilisation is taking’, the defining feature of Auroville’s founding. ‘So far, so good’, but there are ‘limitations of our knowledge and experience on this new path and the possibility of serious errors and stumblings.’¹⁰ This comes from two warring tendencies: an unregulated vital individualism, that resists the bonds of communal contact or from a communal egoism, that rejects the individual as a distinct unit. The former dynamic presents itself – at least as far as the records indicate, sporadically – in the early years in Auroville, given both the cultural profile of the early migrants and the sparsely settled landscape, with a continuing imprint since.¹¹ This is both natural and expected in Sri Aurobindo’s scheme. One may see this, for example, in Mother’s early conversations in the *Agenda*, insisting on the distinction between desire-driven license and disciplined, spiritual liberty in Auroville’s emerging value-economy. For example, on 17th February, 1968, at the founding, she clarified the conflation of ‘dangerous (vital) extravagances’ that threaten ‘the movement of (spiritual) transformation and rising above’:

S.: I find her paper [of a correspondent at the time] harmful, for not only does it not bring anything, but it opens the door to ambiguity. And it says nothing: the ‘hippies’ too are ‘children of love’, that’s their great doctrine.

To tell the truth, when I opened that paper, I felt disgust. If I had confidence in her, I would put it differently – I would immediately put: ‘... which, from the spiritual point of view is a disaster.’ Only ... it’s pointless to make people angry. She has no trust at all, she believes she’s infinitely superior. Only, politically she’s very careful not to enter into open conflict [with Mother] because she feels that would hinder her action. She wanted – and she said that I had authorised it (which is a distortion of the truth) – she wanted to start an LSD club in Auroville. Because I wrote her ... being as objective as possible, you see I wrote that it could only be used under the supervision of people who have a spiritual knowledge AND the capacity to control and help. So she turned that around and said, ‘Mother authorised it on the condition that it is under the control of people who know.’

There you are. People who know, of course Basically, in life, in action, all that happens happens so that the movement of transformation and rising above may be as quick as possible. Perhaps there are some periods – there is a rhythm and there are periods which are more favourable to harmony, but a stagnant harmony, and so there is an attempt to suppress or in any case to repress all the dangerous movements which threaten to halt progress or even lead to destruction; but there are other moments when there is a very strong push towards the transformation, and indeed ... with the risk of possible damage.

¹⁰ Sri Aurobindo, CWSA, 1997, Vol. 25, 45.

¹¹ See, for example, Shinn, 1984.

And most certainly, since 1956, one clearly sees that there is something pushing-pushing-pushing to hasten the movement and ... that gives rise to extravagances that are very dangerous. It's with this knowledge and this certitude – this vision of things – that more often than not, I remain a witness and do not interfere. It is only if things become really nasty that one is forced to intervene. We'll see.¹²

Elsewhere, in speaking of Auroville, she registers a caution on this front:

To be a man, discipline is indispensable. Without discipline one is only an animal. One begins to be a man only when one aspires to a higher and truer life and when one accepts a discipline of transformation. For this one must start by mastering one's lower nature and its desires ... Yes. Oh, they're all quarrelling among themselves! And some even disobey deliberately; they refuse to recognise any authority.¹³

... there's quite a lazy group in Auroville! People who don't want to work ... No, they have to be told: you're talking nonsense ... They're terribly angry with me because I told them discipline is indispensable. That's old hat, you see.¹⁴

The egoistic vital reactions must disappear before anything serious can be done.¹⁵

Liberty does not mean to follow one's desires but, on the contrary, to be free from them ... They have in the name of liberty taken abominable licentiousness.¹⁶

The Aurovilian must not be a slave to his desires. The idea is this: 'We come to Auroville to escape social and moral rules that are artificially practiced everywhere, but it is not to live in the licentiousness of the satisfaction of every desire: it is to rise above desires in a truer consciousness.' Something like that ... It appears they quite need this! (Mother laughs) So we should add it. We could draw up a whole program, that would be interesting enough.

[S.: Yes, but in the practical order, until people go a little behind appearances and stop living on the surface of themselves, nothing will mean anything!]

But all that is precisely what they need to be told! ... [Mother substitutes 'condition' for 'necessity' in 'To be a True Aurovilian' in relation to the 'inner discovery.']¹⁷

And they use the liberty for license, for the satisfaction of desires, and all these things that we truly have worked all our life to master, they indulge in dissipation. I am absolutely disgusted.¹⁸

d. The Vital and Mental Movement

The challenges for Auroville, for the collective yoga, were thus in securing that collective aspiration for liberty *upwards* towards the supra-rational, which alone can sustain the 'anarchist' inspiration from challenges. The ground for this aspiration upwards found a natural ground in the environmental ethic, with the oil crises, 'limits to growth' and other movements in the backdrop. Yet, the 'vital' and 'mental' base had to be built for the 'city' to attempt an

¹² Guigan, 2018 Vol. 1, 251-3.

¹³ Guigan, 2018, Vol. 2, 327.

¹⁴ Guigan, 2018, Vol. 2, 250-2.

¹⁵ Guigan, 2018, Vol. 2, 257.

¹⁶ Guigan, 2018, Vol. 2, 457, 274.

¹⁷ Guigan, 2018, Vol. 2, 137-9.

¹⁸ Guigan, 2018, Vol. 2, 341.

integral realization, not an ascetic, village / rural or otherwise life-denying one. That task – anticipated, yet not undertaken in the earnest till the 90s – was kept, in a sense, on the backburner to attend to the more pressing concerns of the time. Proposals indeed were made aplenty, yet the energy of the collective was not yet turned to that enterprise.

As the first wave of environmental works yielded fruit – securing the physical base, though still subject to the remaining lands yet to be acquired and water management concerns which are both existential, material challenges for Auroville – the construction of the Matrimandir, a common and uniting enterprise, which embodied that early aspiration in form, occupied the collective’s energies in a significant way. The symbolism – of working the Earth, in regenerating the land, of working on the Matrimandir, building its soul – is unmistakable. With the Matrimandir nearing completion in the early 2000s, the full flush of the collective ‘vital’ and ‘rational’ works – housing and infrastructure, commerce and industry, organization and governance – kept in a sense in abeyance till then, came to the fore. The turn of the century, with the Masterplan, documents this (resistant) shift. It is here that the core of the urban governance challenge yet remains, to find ways to organize the collective in order to build and transform the vital and mental worlds in their fullness. Simply put, what is required is a progressively unifying *collective* action to build the ‘city’, beginning with close vital and mental contact through a deepening economic, social and administrative fabric, not a patchwork of individual enterprise operating in loose association:

Man’s communities are formed ... by local association, community of interests and community of ideas; and these limits tend always to be overcome in the widening of human thoughts and sympathies brought about by the closer intermingling of races, nations, interests, ideas, cultures. Still, if overcome in their separatism, they are not abolished in their fact, because they repose on an essential principle of Nature, diversity in unity.¹⁹

e. From Geographic to Political Unity

Turning to Sri Aurobindo’s schematic, the challenge, following from the geographic oneness, secured through the purchase and settlement of the lands, is the administrative and political union of the collective. The progress is worth pausing and reflecting on for a moment, for in it relies the move from the body of the collective to its soul. Sri Aurobindo outlines the movement thus:

In building up her human aggregates, Nature has followed in general principle the same law that she observes in her physical aggregates. She has provided first a natural body, next, a common life and vital interest for the constituents of the body, last, a conscious mind or sense of unity and a centre or governing organ through which that common ego-sense can realise itself and act.²⁰

In building Auroville, then, comes first the natural body, a geographical oneness. Securing and inhabiting the plan area was the first port of all to build a distinct Auroville aggregate. The pioneering forestry of the early years served not only the critical environmental ethic, but a

¹⁹ Sri Aurobindo, CWSA, 1997, Vol. 25, 422.

²⁰ Sri Aurobindo, CWSA, 1997, Vol. 25, 326 (emphasis ours).

spiritual one in that it created a beautiful haven, a foundation, for all to reside together. Sri Aurobindo explains:

There must be in her ordinary process either a common bond of descent or past association that will enable like to adhere to like and distinguish itself from unlike and a common habitation, a country so disposed that all who inhabit within its natural boundaries are under a sort of geographical necessity to unite. In earlier times when communities were less firmly rooted to the soil, the first of these conditions was the more important. In settled modern communities the second predominates; but the unity of the race, pure or mixed for it need not have been one in its origin remains a factor of importance, and strong disparity and difference may easily create serious difficulties in the way of the geographical necessity imposing itself with any permanence.²¹

The distinct feature of Auroville, in contrast to other collectives, was that there was no ‘common bond of descent or past association’ that ‘so disposed all ... under a sort of geographical necessity to unity’. Quite the contrary: the pioneers were an eclectic, motley crew, with little by way of common descent. What united them was not ethnicity, language or past association, but an *ideal*: ‘all men of goodwill ... who thirst for progress’. A cosmopolitan family – at times warring, as families do – united by a vision. This in itself is a remarkable feature of the founding moment: for what, one may ask, could unite such a diverse group, with little in common by way of the usual markers of a family, clan or tribe? The bonds were not of blood, but of the aspiring soul – with all its imperfections – held together by the living and infinite force of the Mother.²²

Auroville’s inauguration on 28th February, 1968, was a grand symbol to ground this sentiment – soil, the gross physical, from 124 countries and 23 Indian states, all bound together at the centre of the town, next to its soul. The first of Nature’s law was accomplished symbolically with spiritual force. Accounts from the early years display the unlikely camaraderie, in community kitchens, hut settlements, evening theatres, single-teacher schools, bullock-carts and crowbars. A time for innocence and joy, bound together in a search for something new. The move from the ‘objective’ to the ‘subjective’ – discussed in Part I, from a rational ordering to a supra-rational one – Sri Aurobindo notes, starts with the land:

This objectiveness comes out very strongly in the ordinary emotional conception of the nation which centres round its geographical, its most outward and material aspect, the passion for the land in which we dwell, the land of our fathers, the land of our birth, *country, patria, vaterland, janma bhumi*. When we realise that the land is only the shell of the body, though a very living shell indeed and potent in its influences on the nation, when we begin to feel that its more real body is the men and women who compose the nation-unit, a body ever changing, yet always the same like that of the individual man, we are on the way to a truly subjective communal consciousness. For then we have some chance of realising that even the physical being of the society is

²¹ Sri Aurobindo, CWSA, 1997, Vol. 25, 326.

²² The following poem from the region, originally in Tamil, brings to mind the barren red earth and heavy rainfall that was the pioneers’ common ground in their labour of love: ‘Who is your mother to mine, or / how is my father related to yours? / You and I – how did we know each other? Yet, / like red earth and rainwater, / our hearts, / they dissolved in love.’

a subjective power, not a mere objective existence. Much more is it in its inner self a great corporate soul with all the possibilities and dangers of the soul-life.²³

The regeneration of the body, Auroville's land, 'the outer shell', through a patient, nurturing and vital infusion of life – seed by seed, planting the Earth to revive life – was the work of the early foresters. As the lands were settled, the early residents 'learned about the rhythms and culture' of the people and nature, a daily, hard and happy communion with the land to mark it as their own – the creation of a 'living and potent shell', the 'physical being' of Auroville infused with a 'truly subjective communal consciousness'. As we alluded to above, the interposition of land regeneration and the building of the Matrimandir, the two primary tasks of the early years, carries a significance – evolution from below, the hard objective, and from above, the sublime spiritual, proceeding apace together. A crowbar in one hand and plans for a futuristic temple on the other, each equally consecrated to the Divine.²⁴ One thus cannot overemphasize the potency and significance of the early work, much as one is liable to forget and rest easy in the comforts of the shade it has bequeathed to us today. The living sense of geographical oneness, of residing together in the sacred lands of Auroville – lived on by those departed and those to come, our family past and future – and not just a bare territorial commonality forms the foundation of the communal yoga. This, we may also note, is cemented as time passes through webs of narrative and histories that keep alive the bond. As the pioneer generation gives way to the next, this task of sustaining a living sense of belonging will present itself, as indeed is already the case with nascent steps towards 'succession planning' to handover the reigns to the emerging generation.

This, then, was the first and in a sense, continuing, stage in building the Auroville aggregate. Yet, it is of itself imperfect, unless followed by the second – a 'common life and vital interest for the constituents of the body' – and the third – 'a conscious mind or sense of unity and a centre or governing organ through which that common ego-sense can realise itself and act', onwards to the final and yet unspecified stage of psychological oneness. Sri Aurobindo explains:

In order that it [geographical oneness] may impose itself, there must be a considerable force of the second natural condition, that is to say, a necessity of economic unity or habit of common sustenance and a necessity of political unity or habit of common vital organisation for survival, functioning and aggrandisement. And in order that this second condition may fulfil itself in complete force, there must be nothing to depress or destroy the third in its creation or its continuance. Nothing must be done which will have the result of emphasising disunity in sentiment or perpetuating the feeling of separateness from the totality of the rest of the organism; for that will tend to make the centre or governing organ psychologically unrepresentative of the whole and therefore not a true centre of its ego-sense. But we must remember that separatism is not the same thing as particularism which may well coexist with unity; it is the

²³ Sri Aurobindo, CWSA, 1997, Vol. 25, 36.

²⁴ Lohmann's moving account, a spiritual travelogue, unmoving yet travelling in inner space, captures the heart of this movement. Lohmann, 1972, 1986.

sentiment of the impossibility of true union that separates, not the mere fact of difference.²⁵

True to the scheme, a growing union at the vital and mental levels came as the next stages in the progressive unification of Auroville. They are continuing today and, in a sense, determining developments through the uneasy, yet creative, friction that Auroville is currently witnessing, which formed the backdrop of our study. The ‘vital’ work, which emerged from the 80s onwards, was to build the economy, housing, social and physical infrastructure and services, alongside the administrative unification under the AVF Act in 1988. Some years later, from the mid-90s onwards, with a vital base slowly emerging came the ‘mental’ push, with piecemeal attempts at rationalization of codes, policy-making, coordination, planning and organization.

This movement – outlined in our sectoral overview in Part III – came in the following broad chronology, which maps on fuzzily to Sri Aurobindo’s scheme. In the founding years, the Sri Aurobindo Society, headed by Mother, and the Committee for the Administration of Auroville, headed by Anger, led the charge. After Mother’s passing, a period of political instability ensued with independent and collective initiatives operating *ad hoc*. Alongside, the Development Group and Pour Tous emerged, with smaller experiments in Seed, Envelopes and later the Circles group. Incipient organizational attempts followed with the Artisana Trust, the Economy Group, later the New / Enlarged Economy Groups and the Finance / Financial Development Groups. In 1984 then came SAIER (with seven proposed sub-groups / faculties that did not manifest, and later the Auroville and Outreach School Boards as nodal bodies), followed by a formal administrative unification and organization of Auroville under the umbrella of the AVF Act, which created the Residents’ Assembly, Governing Board and International Advisory Council, providing a firm, on-paper, legal architecture. Soon thereafter emerged the Central Fund, the Auroville Board of Commerce / later Auroville Board of Service, the Finance and Asset Management Committee, later the Budget Coordination Committee.

In the late 1990s, further administrative action ensued with the Land Use and Land Coordination Group in charge of drafting the Residents’ Assembly Masterplan, finalized later at the 2001 Masterplan (Perspective: 2025) that, in its ideal, was to function as a unifying policy

²⁵ Sri Aurobindo, CWSA, 1997, Vol. 25, 326. An explanatory caveat is in order here. Sri Aurobindo refers in this passage to the ‘corporate ego-sense’. This reference applies to the natural process of building collectives in the mega-history he narrates in *The Ideal of Human Unity*, addressing large collectives from the Roman and Gupta empires to the modern Teutonic and Indian nations. In that landscape, the growth of the corporate-ego precedes the ultimate translation of that egoistic unity, false yet valuable, to a spiritual one, the ‘group-soul’. This movement accompanies and follows the same trajectory, but with greater complexity, as the necessary development and individuation of the individual ego before it can aspire to transcendence to the psychic being or individual soul. The ego, for Sri Aurobindo, is not unnecessary in early stages of development. To the contrary, it is needed and necessary as an ‘interim’ vehicle or mould (in the epochal scale at which he is speaking) that may ultimately grow to surpass its separative sense, part of the involutory *lilā* in which the Divine hides himself in the ego for the sport of recovering his own self. The challenge of the communal *yoga*, as in the individual *yoga* of each resident, is to hasten this shift to discover the ‘group-soul’ of Auroville with which one mingles. This group-soul is the living manifestation of the ideal of human unity. As we discuss below, this universalizing movement happens in gradations, step-wise, through a growing interchange and communion with smaller collectives with whom one is direct, daily contact onwards to a broader unification as one expands one’s circle of identification and belonging – if so, the nurturing of neighbourhoods and wards, research, cultural and professional clusters and other smaller collectives at the zonal and sub-zonal levels is an important governance or institutional design feature for the social fabric that can facilitate this movement by defining those moulds clearly to encourage participation.

document to guide city-activities across sectors, an attempt at rational ordering and planning. In this, it proposed an organizational structure in Appendix V, which rationalizes and reorders efforts characteristic of the ‘rational age’ in the evolutionary curve. Around this time, by the early 2000s, emerged the first attempts at organizing the farm and forestry sectors, with the Forest Group and Auroville Centre for Ecological Land Use and Rural Development (Palmyra) to coordinate activities around soil and water conservation, afforestation, wasteland reclamation etc. In 1978, 13 Auroville farms had organized into a cooperative system which was later re-organized in 1994 as the Farm Group. The Farm and Forestry groups later created a combined Green Group for effective representation. Alongside emerged the Auroville Village Action Group to organize outreach activities, with the the Auroville Health Services and Health Fund formed in 2001 and 2002 respectively. Soon thereafter came a strengthening of the FAMC and BCC, the formalization of the Auroville Council, the institution of the Town Development Council (following on from the Development and Planning Groups and Aurofuture) in 2009, with 4 subsequent avatars till 2020, and the establishment of the Zonal Groups), the Housing Group and Service (with the first attempt at policy planning in the sector emerging with the 2011 Housing Policy), Land Board (and its various iterations, including the Land Service, Land Consolidation Committee, Land and Estate Management Group, Land & Resources Management Committee, Land Matters Task Force and Lands for Auroville Unified). In this period also came various ‘minor’ bodies, each meant to organize various aspects of hitherto uncoordinated or loosely coordinated work: the Project Coordination Group, the Fundraising Cell, the short-lived Vision Task Force (as part of the 2015 Retreat process), the institution of the Residents’ Assembly Service in 2017, the 2019 Entry Service and Board (with the 2017 Entry Policy, as the first comprehensive articulation of entry processes and principles), the Residents Assembly Service and the Residents’ Service to secure the process integrity of the Residents’ Assembly and offer administrative support for residents’ visa processing, the Outreach / Auroville Media cell for strategic communications, Savi and later the Youth Forum for volunteer work and youth engagement in civic matters, the Organization Research Group, Guest Facilities Coordination Group (which also manages the Guest Registration and Accommodation Service) for tourism and guest house management, the Messenger Service, akin to internal postal service, the Vehicle Service, the Security Task Force (now the STTF, along with the Ambulance Service and the MERA group, for emergency response), the COALA Group for coordination of Auroville learning activities, the Data Management Group, the Human Resources Hub for resource personnel and others.

Through these movements, Auroville has 34 trusts and over 600 units for commercial and non-commercial activity, and from our review, over 53 Working Groups or management bodies from 2001-23, of which at least 26 are currently operational in one form or another. What seems to emerge from this quick macro walk-through of the rather heady dynamic of group formation and organizational structuring is:

- i. A growing recognition of the need for institutionalization to solve coordination problems, which is a characteristic of the ‘rational stage’, of administrative, economic and social union.

- ii. An emphasis on the need for regulatory infrastructure, yet with a resistant centralization. There appears to be a preference for a culture of ‘small-group democracy’, coming up, as such efforts inevitably do, against problems of complex institutional processes with an unclear definition of mandates, weak executive powers and uncertain linkages between subsystems.
- iii. A responsive, ‘organic’, though at times unsystematic and *ad hoc*, approach to institutional structuring, perhaps necessary historically as part of Auroville’s growth trajectory, in need of rationalization and streamlining today as we discuss below.

In these shifting sands of institutional development – an incipient Auroville ‘bureaucracy’ especially since 2001 – there is a distinct push to develop a ‘vital’ and ‘mental’ infrastructure as in Sri Aurobindo’s evolutionary scheme. A deeper analysis of each these bodies would be interesting and required in this mapping exercise, yet beyond our current scope.

In this movement, attitudes attendant to early-stage subjectivism discussed above still seemed to predominate, with a persistent, yet at times, premature, rejection of rational ordering. This emerges most clearly in the preference for ‘organicity’ as opposed to ‘planned’ development particularly in city-planning, urban infrastructure development and housing. As we discussed in Part II, while growth is naturally evolving, with iterative changes to plans, the demand for ‘organicity’ risks rejecting an ordered growth necessary for the health of an organism – in many sectors, this seems to be the case, with a raft of planning and policy frameworks proposed for cohesive and efficient working, yet not finalized. Unless chastened by an inner law, the rejection of rational ordering risks a free play of a vital subjectivism, seemingly the case here. It is also unsurprising that the two sectors in which the greatest reluctance has been witnessed for firm organization that of economy and governance, which Sri Aurobindo singles out as the ‘hard refractory earthy matter which most resists all but a gross utilitarian treatment’, liable to the greatest misuse.²⁶ Whilst the aspects of Love, Beauty and Wisdom are intuitively appealing to the collective, those of Power – embodied most clearly in the economic and governance sectors, which invite the popularly corrupting influences of capital and authority – are most resisted.

What emerges from this short mapping of the evolutionary landscape to Auroville’s empirical growth trajectory is the incipient movements for vital and mental unification post the late 80s – in this, a nostalgic remembrance of the free play of the early days and a rejection of collective rational ordering in the bureaucratic disposition of the Working Groups is part of the creative conflict engendered in the movement to greater unity. Particularly as densities increase, the communal yoga must deepen this deeply difficult, yet needed, engagement, rather than fall back into a false vital subjectivism disguised as a supra-rationalism:

And old ideal voices wandering moaned
 And pleaded for a heavenly leniency
 To the gracious imperfections of our earth
 And the sweet weaknesses of our mortal state.

²⁶ Sri Aurobindo, CWSA, Vol. 25, 248.

This now he willed to discover and exile,
The element in him betraying God.
All Nature's recondite spaces were stripped bare,
All her dim crypts and corners searched with fire
Where refugee instincts and unshaped revolts
Could shelter find in darkness' sanctuary
Against the white purity of heaven's cleansing flame.²⁷

Given relatively slow movement on the governance front in recent years, this is still – at the *collective* level – an incipient movement in Auroville, with weakly organized forms of collective visioning and action in preference for a loosely ordered network of semi-autarchic nodes each pulling in their own direction. The subjection of collective concerns – in housing, economy, urban infrastructure development and others – to a planned and ordered rational scheme is not inconsistent with the path of the yoga, but rather, a constituent part of it. As one rises up from the geographical to administrative, vital and mental unity, what we may call the 'y' axis, appropriate centralization through a common regulatory architecture, the 'x' axis, is important to balance the twin concerns of unity and diversity, of unification and dissipation, which is currently leaning heavily towards the latter. We address this briefly.

iii. Collectivism, Individualism and Resistant Centralization: the 'X' Axis

The upward movement, from the physical, geographic oneness to the spiritual, psychological oneness is accompanied at each stage by a horizontal movement, navigating between the two principles of collective organization: individualism and collectivism, the urge for the freedom of the individual and that of the cohesion of the collective. The crux of the communal yoga is in harmonizing the apparent and persistent contradictions between them. Mother and Sri Aurobindo outline this movement:

Also, in this effort to improve human conditions, there have always been two tendencies, which seem to be contrary but which ought to complement each other so that progress may be achieved. The first advocates a collective reorganisation, something which could lead to the effective unity of mankind. The other declares that all progress is made first by the individual and insists that the individual should be given the conditions in which he can progress freely. Both are equally true and necessary, and our effort should be directed along both these lines at once. For collective progress and individual progress are interdependent. Before the individual can take a leap forward, at least a little of the preceding progress must have been realised in the collectivity. A way must therefore be found so that these two types of progress may proceed side by side.²⁸

Freedom and harmony express the two necessary principles of variation and oneness, freedom of the individual, the group, the race, coordinated harmony of the individual's forces and of the efforts of all individuals in the group, of all groups in the race, of all races in the kind, and these are the two conditions of healthy progression and successful arrival. To realise them and to combine them has been the

²⁷ Sri Aurobindo, CWSA, 1997, Vols. 33-34, 318.

²⁸ Mother, CWM, 2002, Vol. 12, 39-40.

obscure or half-enlightened effort of mankind throughout its history, a task difficult indeed and too imperfectly seen and too clumsily and mechanically pursued by the reason and desires to be satisfactorily achieved until man grows by self-knowledge and self-mastery to the possession of a spiritual and psychical unity with his fellow-men. As we realise more and more the right conditions, we shall travel more luminously and spontaneously towards our goal and, as we draw nearer to a clear sight of our goal, we shall realise better and better the right conditions. The Self in man enlarging light and knowledge and harmonising will with light and knowledge so as to fulfil in life what he has seen in his increasing vision and idea of the Self, this is man's source and law of progress and the secret of his impulse towards perfection.²⁹

The following schematic presents a simplified, indeed caricatured, representation of these movement.

²⁹ Sri Aurobindo, CWSA, 1997, Vol. 25, 66.

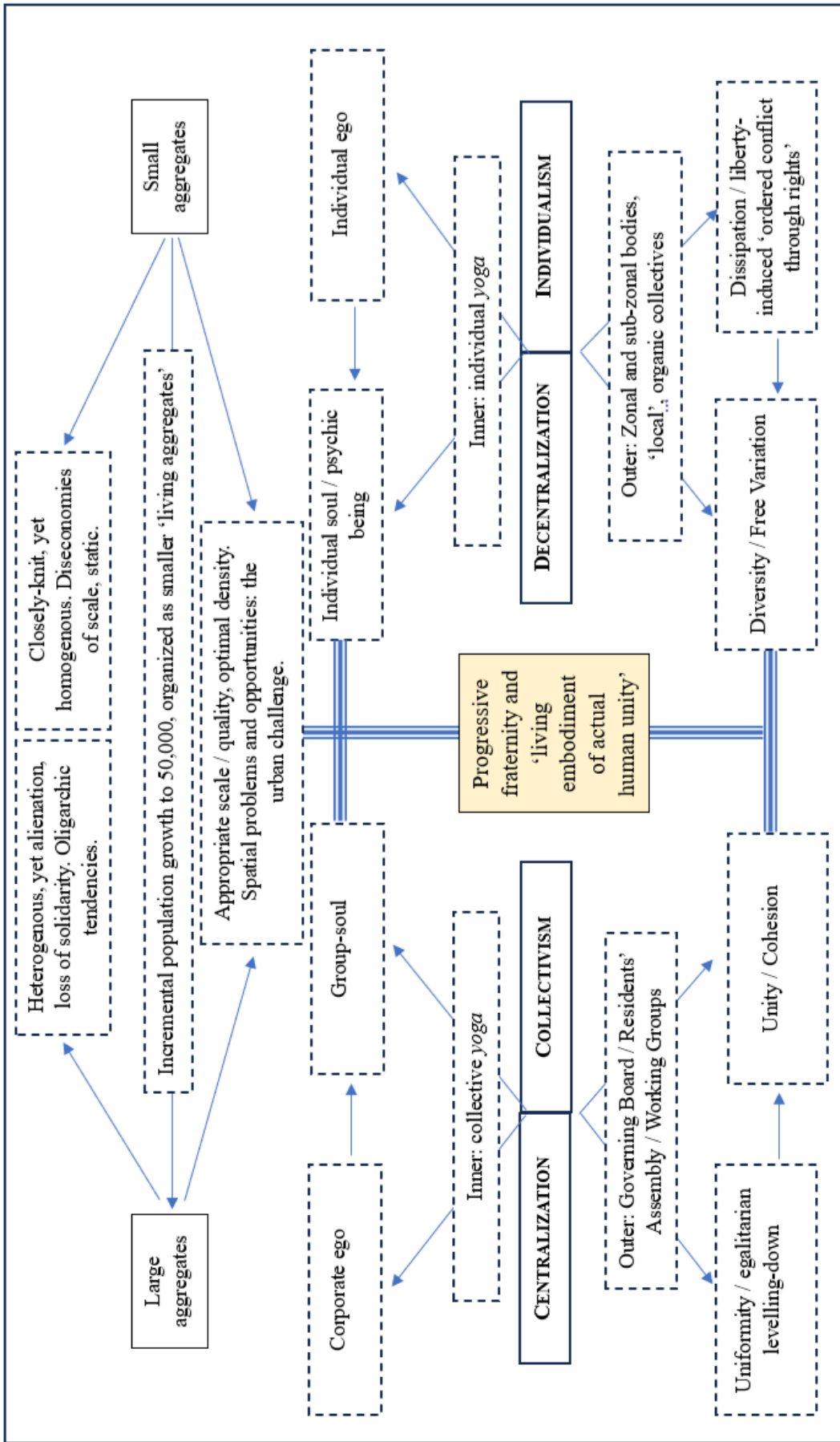

Simplified schematic of agglomeration dynamics in Auroville

A fuller discussion of these dynamics is beyond our scope, but a few salient points emerge. As we discussed in Part I, Sri Aurobindo locates the contrary pulls of individual and social streams in a democratic experiment as a necessary historical dialectic – through collaboration or through struggle – towards a progressive harmonization:

This is done primarily through the individual man; for this end man has become an individual soul, that the One may find and manifest Himself in each human being. That end is not indeed achieved by the individual human being in his unaided mental force. He needs the help of the secret Divine above his mentality in his superconscient self; he needs the help also of the secret Divine around him in Nature and in his fellow-men. Everything in Nature is an occasion for him to develop his divine potentiality, an occasion which he has a certain relative freedom to use or to misuse, although in the end both his use and misuse of his materials are overruled in their results by the universal Will so as to assist eventually the development of his law of being and his destiny. All life around him is a help towards the divine purpose in him; every human being is his fellow worker and assists him whether by association and union or by strife and opposition.³⁰

In Sri Aurobindo's articulation, the two processes, of individual and communal perfection, proceed apace, though with a tilt to the individual as the leader of the march, casting the imprint of the advance achieved through individual progress on the community:

Thus the law for the individual is to perfect his individuality by free development from within, but to respect and to aid and be aided by the same free development in others. His law is to harmonise his life with the life of the social aggregate and to pour himself out as a force for growth and perfection on humanity. The law for the community or nation is equally to perfect its corporate existence by a free development from within, aiding and taking full advantage of that of the individual, but to respect and to aid and be aided by the same free development of other communities and nations. Its law is to harmonise its life with that of the human aggregate and to pour itself out as a force for growth and perfection on humanity. The law for humanity is to pursue its upward evolution towards the finding and expression of the Divine in the type of mankind, taking full advantage of the free development and gains of all individuals and nations and groupings of men, to work towards the day when mankind may be really and not only ideally one divine family, but even then, when it has succeeded in unifying itself, to respect, aid and be aided by the free growth and activity of its individuals and constituent aggregates.³¹

The need for densities in Auroville in this process is critical, for the creative friction that results from the close contact of diverse temperaments and types, which is grist for the spiritual mill. There will be, in Auroville as elsewhere, though hopefully on a quicker timescale and with a concentrated movement, a 'clumsy adjustment' to accommodate diversity in close quarters, with 'stumblings and hesitations and deviations and a series of violences done to himself and others', a movement to that underlying unity *in proportion* to each resident and each type (of nationality or temperament) within the community achieving the inner purification:

³⁰ Sri Aurobindo, CWSA, 1997, Vol. 25, 65.

³¹ Sri Aurobindo, CWSA, 1997, Vol. 25, 71.

Naturally, this is an ideal law which the imperfect human race has never yet really attained and it may be very long before it can attain to it. Man, not possessing, but only seeking to find himself, not knowing consciously, obeying only in the rough subconsciously or half-consciously the urge of the law of his own nature with stumblings and hesitations and deviations and a series of violences done to himself and others, has had to advance by a tangle of truth and error, right and wrong, compulsion and revolt and clumsy adjustments, and he has as yet neither the wideness of knowledge nor the flexibility of mind nor the purity of temperament which would enable him to follow the law of liberty and harmony rather than the law of discord and regimentation, compulsion and adjustment and strife. Still it is the very business of a subjective age when knowledge is increasing and diffusing itself with an unprecedented rapidity, when capacity is generalising itself, when men and nations are drawn close together and partially united though in an inextricable, confused entanglement of chaotic unity, when they are being compelled to know each other and impelled to know more profoundly themselves, mankind, God and the world and when the idea of self-realisation for men and nations is coming consciously to the surface, it is the natural work and should be the conscious hope of man in such an age to know himself truly, to find the ideal law of his being and his development and, if he cannot even then follow it ideally owing to the difficulties of his egoistic nature, still to hold it before him and find out gradually the way by which it can become more and more the moulding principle of his individual and social existence.³²

The dynamic dance of the centralizing tendency, aspiring to oneness, and the decentralizing one, aspiring to free variation, form the ontological battleground of Auroville's development: the disunity and apparent separateness of the forms of the Inconscient aspiring, through the growing, necessarily unstable and fractious interchange of physical, vital and mental associations, to the unity of the Divine *sachchidānanda* consistent with the evolutionary *telos*. This is, we may hazard to say, a socio-political reflection of the dialogue between Love and Death in *Savitri*. Disharmony in Auroville's collective is then a part of the play, indeed the very substance of it, that one would naturally expect:

Human life is moved by two equally powerful impulses, one of individualistic self-assertion, the other of collective self-assertion; it works by strife, but also by mutual assistance and united effort: it uses two diverse convergent forms of action, two motives which seem to be contradictory but are in fact always coexistent, competitive endeavour and cooperative endeavour. It is from this character of the dynamism of life that the whole structure of human society has come into being, and it is upon the sustained and vigorous action of this dynamism that the continuance, energy and growth of all human societies depends. If this life-force in them fails and these motive-powers lose in vigour, then all begins to languish, stagnate and finally move towards disintegration.

...

Freedom and harmony express the two necessary principles of variation and oneness, freedom of the individual, the group, the race, coordinated harmony of the individual's forces and of the efforts of all individuals in the group, of all groups in the race, of all races in the kind, and these are the two conditions of healthy progression and successful arrival. To realise them and to combine them has been the

³² Sri Aurobindo, CWSA, 1997, Vol. 25, 71-2.

obscure or half-enlightened effort of mankind throughout its history, a task difficult indeed and too imperfectly seen and too clumsily and mechanically pursued by the reason and desires to be satisfactorily achieved until man grows by self-knowledge and self-mastery to the possession of a spiritual and psychical unity with his fellow-men. As we realise more and more the right conditions, we shall travel more luminously and spontaneously towards our goal and, as we draw nearer to a clear sight of our goal, we shall realise better and better the right conditions.

So only can the race itself attain to anything profound, living and deep-rooted. It cannot be done brutally, heavily, mechanically in the mass; the group self has no true right to regard the individual as if he were only a cell of its body, a stone of its edifice, a passive instrument of its collective life and growth. Humanity is not so constituted. We miss the divine reality in man and the secret of the human birth if we do not see that each individual man is that Self and sums up all human potentiality in his own being. That potentiality he has to find, develop, work out from within. No State or legislator or reformer can cut him rigorously into a perfect pattern; no Church or priest can give him a mechanical salvation; no order, no class life or ideal, no nation, no civilisation or creed or ethical, social or religious Shastra can be allowed to say to him permanently, 'In this way of mine and thus far shalt thou act and grow and in no other way and no farther shall thy growth be permitted.' These things may help him temporarily or they may curb and he grows in proportion as he can use them and then exceed them, train and teach his individuality by them, but assert it always in the end in its divine freedom. Always he is the traveller of the cycles and his road is forward.³³

The individual revolt against customary codes of the conventional age, an attempt to discover a self-authenticating truth – this evolution, a resistance of authority, is 'historically inevitable'. Man has, in his view to, 'to rise in revolt; on every claim of authority he has to turn the eye of a resolute inquisition.' Yet, in this movement, an assured basis for a social order, to regulate activities in the public domain, is necessary – this is so either for practical ends, to co-ordinate action, or for deeper ends, to satisfy the inner urge for association and union with the Self represented in the collective. This dynamic is the fulcrum which animates the *Ideal of Human Unity*. The *rajasic* temper of this liberation of the individual from collective control naturally brings with it conflict and assertion, an egoistic clash, that dents the *tamasic* collectivism of conventional societies, yet aspires to a higher collectivism born of voluntary and equal association. In this upward movement, from the physical to psychological oneness, through the working of the *gunas*, arises the play of centralization and decentralization. Centralization demands a collective regulation of life, to arrive at an efficient ordering of competing claims while decentralization demands the freedom of the individual from external (over) regulation. This dynamic, discussed at length in the literature, is given a psycho-spiritual significance by Sri Aurobindo.

The decentralizing tendency is necessary for the free play and development of the individual, the *nodus* of creativity and discovery. Yet, if unregulated, its dissipating potential yields an aggregative, atomistic outlook, one where community is a summation of distinct units rather than a collective, even if somewhat nebulous whole. This has adverse practical and cultural consequences, with sub-optimal efficiency for common works and a weakening of the bonds

³³ Sri Aurobindo, CWSA, 1997, Vol. 25, 157, 66-7.

of solidarity. The centralizing, collectivist tendency is necessary for the development of the social being, the corporate entity. Yet, if unregulated, the collective ordering – which in the end translates into the control of a minority acting in the name of the collective, the Working Groups in Auroville’s case – risks an unhealthy intrusion in to the individual domain, restricting enterprise either on an ideological level or a bureaucratic or regulatory level, which hinders diversity. As the individual ego, and the group-ego, ascends the physical-vital to spiritual planes, one may expect the swinging of the pendulum from one to the other, through a complex clashing of these forces. This reflects the unstable balance of forces in the collective between the *tamasic*, *rajasic* and *sattwic* modalities discussed in Part I. Accordingly, Sri Aurobindo argues that in proportion to the inner development, the outer forms develop – centralized, decentralized or federated – to achieve that balance. The creative friction resulting from closer contact and interchange, through economic, administrative and cultural linkages, is then part of the political *līlā*, proceeding quickly or slowly to the *telos* of the fraternal oneness that is the evolutionary necessity. A rational ordering is necessarily unstable, though indispensable as a preparatory stage, because the unruly instincts of the vital, heightened in a false vital subjectivism, can be temporarily dimmed by ethical control but not entirely transformed. The mind is simply not powerful enough to control the life-force, without drying it up.

The demand for centralization arises both at the practical and psychological levels, the first to secure a workable and efficient ordering of collective energies for productive and peaceful ends that can only be secured by co-ordinated common action, and the second, as a hidden push to discover the underlying unity of collective-types. This latter aspiration is what Sri Aurobindo labels the ‘group-soul’ – a conscious collective being and identity – an association and living interchange, not simply an aggregation, of individual souls. As the individual ego progresses through the complex step-wise ascension to the psychic being, an underlying fraternity, or identity with the ‘group-soul’, emerges, born of physical, vital, mental and spiritual union in advanced stages of progress. Similarly, the decentralizing tendency arises at the practical level, as a means to secure the privacy and space for individual action and at a deeper level, as the pathway to discover the psychic being, the unique and distinctive Divine element in each.

In this play, the individual and the collective variously conflict or support, as the stress of evolution demands at that time: individual egos conflicts with each other and the corporate ego conflicts with others groups. Progressively, as the inner evolution and purification results, intra-group individual conflict and inter-group communal conflict resolve, in a union of diverse forms of life, capable of being held in perfect equilibrium only in advanced stages of psychological fraternity. In the long march to that ideal, one of human unity, the physical, administrative / political, social, economic and cultural unification develop through common habits of sustenance and life, constantly navigating the twin plays of centralization and decentralization. The former aspires to sustain collective moulds, yet threatens uniformity and intrusive regulation, while the latter threatens dissipation and atomism. The regulatory challenge in this play is to develop forms of collective organization that can, at the level of practical detail, facilitate common action and identity-formation, while preserving space for the free play of the individual. Creative friction is likely in this process, and indeed preferable over the loose urban sprawl today, even as it results in an interim loss of space and peace:

The normal human society starts from the gregarious instinct modified by a diversity and possible antagonism of interests, from an association and clash of egos, from a meeting, combination, conflict of ideas, tendencies and principles; it tries first to patch up an accommodation of converging interests and a treaty of peace between discords, founded on a series of implied contracts, natural or necessary adjustments which become customs of the aggregate life, and to these contracts as they develop it gives the name of social law. By establishing, as against the interests which lead to conflict, the interests which call for association and mutual assistance, it creates or stimulates sympathies and habits of helpfulness that give a psychological support and sanction to its mechanism of law, custom and contract. It justifies the mass of social institutions and habitual ways of being which it thus creates by the greater satisfaction and efficiency of the physical, the vital and the mental life of man, in a word, by the growth and advantages of civilisation. A good many losses have indeed to be written off as against these gains, but those are to be accepted as the price we must pay for civilisation.³⁴

Naturally, urban environments, with high density and cosmopolitan profiles, add to the complexity of this dynamic, presenting concentrated habitats for the resolution of these tendencies. The ideal of Auroville, as one such particularly cosmopolitan environment, is tied to how thoroughly this resolution is achieved – ‘an actual embodiment of a living human unity.’ Sri Aurobindo’s discussion on these points is complex and layered – a fuller examination, particularly in conversation with the rich literature on the subject from aligned traditions, is beyond our scope here. Yet, he outlines in the following paragraphs the tension between the individualist and collectivist tendencies, culminating in a call for a fraternal, spiritual ‘anarchism’:

It may be contended as against the anarchistic objection that the collectivist period is, if not the last and best, at least a necessary stage in social progress. For the vice of individualism is that in insisting upon the free development and self-expression of the life and the mind or the life-soul in the individual, it tends to exaggerate the egoism of the mental and vital being and prevent the recognition of unity with others on which alone a complete self-development and a harmless freedom can be founded. Collectivism at least insists upon that unity by entirely subordinating the life of the isolated ego to the life of the greater group-ego, and its office may be thus to stamp upon the mentality and life-habits of the individual the necessity of unifying his life with the life of others. Afterwards, when again the individual asserts his freedom, as some day he must, he may have learned to do it on the basis of this unity and not on the basis of his separate egoistic life. This may well be the intention of Nature in human society in its movement towards a collectivist principle of social living. Collectivism may itself in the end realise this aim if it can modify its own dominant principle far enough to allow for a free individual development on the basis of unity and a closely harmonised common existence. Anarchistic thought, although it has not yet found any sure form, cannot but develop in proportion as the pressure of society on the individual increases, since there is something in that pressure which unduly oppresses a necessary element of human perfection. We need not attach much importance to the grosser vitalistic or violent anarchism which seeks forcibly to react against the social principle or claims the right of man to ‘live his own life’ in the egoistic or crudely vitalistic sense. But there is a higher, an intellectual anarchistic

³⁴ Sri Aurobindo, CWSA, 1997, Vol. 25, 157, 222.

thought which in its aim and formula recovers and carries to its furthest logical conclusions a very real truth of nature and of the divine in man. In its revolt against the opposite exaggeration of the social principle, we find it declaring that all government of man by man by the power of compulsion is an evil, a violation, a suppression or deformation of a natural principle of good which would otherwise grow and prevail for the perfection of the human race.³⁵

The centralizing force is represented in Auroville in the Residents' Assembly, yet loosely organized, and the Working Groups, yet weakly operating. The decentralizing force is represented in individual enterprise and voluntary associations, particularly small-group initiatives. The zonal bodies and 'local' collectives at the sector, ward or neighbourhood level represented an incipient, yet weak, federating force that can mediate these forces, to allow for intermediate group or community development within the larger whole.

Looking back at the historical trajectory of governance mechanisms in Part III, it is apparent that the attempts at administrative, economic and social unification through the Working Groups – all attempting city-wide or sector-wise planning strategies – were in tension with a semi-autarchic ordering, with the absence of the one defining feature of strong centralization: enforcement powers. As Sri Aurobindo notes:

The second stage of the development of the nation-unit [which we may apply to the far smaller scale of Auroville] has been, then, the modification of the social structure so as to make room for a powerful and visible centre of political and administrative unity.³⁶

In a perceptive piece in 1984, as relevant today, Shinn outlined the tension between the unifying force of the Mother, embodied in the Matrimandir, and the autarchic ordering of the collective in its daily activities. He distinguishes between the horizontal and vertical aspects of the spiritual *communitas* – the former arrives through each residents' personal, inner relationship with the Divine, whether represented as the Divine Mother or otherwise, whereas the latter arrives through *inter se* relationship between the residents. For Shinn, the former impulse that animates the individualistic turn has threatened a 'fatal' denting of the bases of social solidarity, with no unifying authority to replace the embodiment of the Divine Mother. This splintering of Auroville, the dissipation of collective energies into independent silos, resonates today. Even if his conclusions of the 'undoing' of Auroville are premature, Shinn's incisive commentary on the autarchic ordering of the collective carries critical lessons today, to translate each one's 'little Auroville' to a common, unified one. In other words, a fraternal fabric within which sub-cultures merge. It is worth quoting at length:

The actual effect of such a dynamic and individualistic 'model for' a city of the future was to permit early settlers to choose the physical location, social rules and economic activity of the communities in which they would reside. Consequently, the early settlements of Forecomers, Udavi, Hope and Aspiration, while springing up within a year of each other, were separated by miles of dirt road made nearly impassable by the monsoon rains. They differed in their rules of conduct and in their economic

³⁵ Sri Aurobindo, CWSA, 1997, Vol. 25, 157, 215-6.

³⁶ Sri Aurobindo, CWSA, 1997, Vol. 25, 157, 378.

activities. The only counterbalance to this individualistic and fragmentary thrust of early 'community development' in Auroville was the symbol of the Matrimandir.

One worker at the centre remarked, 'Oh, that building is different from all the rest... You know the Mother said it [Matrimandir] would be the material receptacle of the Divine force and that people who entered it did not need to meditate or pray, but only concentrate and they would receive a tremendous spiritual charge.' This is the nature of the emotional commitment of those who work to complete the Matrimandir. It had to be finished in order for Auroville to have a centre and for progress toward social unity to be accelerated. However, such reasoning failed to take into account the enduring divisive effects of the social reality (i.e. the disparate communities based upon the individualistic-evolutionary model which have made up Auroville from the beginning). Both spatially and socially these distinctive communities have always mitigated against the spiritual and spatial centring leading to social unity expressed initially in the Mother's plan for the Matrimandir and later in the image of the city as a mandala.

...

The ideal of personal autonomy - bordering on anarchy, at times - is apparent in the obvious absence of officials or institutions which could carry on after the Mother's death to interpret the will of the Divine in particular crisis situations. When inter-community bickering has arisen in competition for scarce material and monetary resources in the absence of the Mother's dictums, no one person or group has been accepted as the official proclaimer of Divine will and adjudication.¹ Likewise, when an Auroville marriage based upon inner spirit instead of social contract failed, who could say which party was responsible for or could claim a right to the child who ideally belonged to the whole Auroville community? With no appointed structure or disciple as mediator of Divine will, each (sic) Aurovilian's autonomy was increased with the Mother's death. The lofty aspiration for 'divine anarchy' has often resulted in a very human form of self-centredness quite antithetical to non-egoistic growth.

...

The overwhelming impression one receives from living in the various communities of Auroville is the extent to which the tension between the individualistic-evolutionary model and the integrative-mandala image has still not been resolved - physically or socially. To be sure, some Aurovilians, like the Frenchman at Udavi, are reaching out in a fraternal expression of care and community concern. Yet even the attempts at community development are often pervaded by a sense of individualism and autonomous decision-making which thwarts a broader co-operation among the various communities of Auroville. Consequently, even though the head of Udavi feels himself to be a 'spiritual brother' with other Aurovilians, he feels little impulse to reach beyond his work, his 'little Auroville'.

... communes and utopias usually have both 'vertical' (between humans and the Divine) and 'horizontal' (between humans and humans) senses of community.' Turner uses the term *communitas* to indicate this socially and experientially liminal state of harmony and equality that can occur in ritual occasions or, more permanently, in intentional communities.

But with the Mother's death, the full weight of Auroville's decision-making processes fell upon her disciples who could not claim her level of spiritual maturation. They

could only claim her continued guidance from the spiritual plane or her previous instructions as feeble attempts to institutionalize her charisma. The ideal vertical model of community assumed that all spiritually advanced individuals would come to similar practical conclusions. What has happened, of course, is that the persons who had as an ideal a harmonious community (horizontal *communitas*) founded on realized individuals (vertical *communitas*) have not in fact, after the Mother's death, agreed on practical issues of ownership and financing of projects in which various groups claim special self-interest.

In answer to the questions raised at the beginning of this essay, the unitary vision of the Mother's dream appears to have placed too great an expectation on the spiritual perfection of individuals (vertical *communitas*) as the basis for social harmony and cooperation (horizontal *communitas*)

The inherent individualistic thrust of the vertical model of *communitas* ... led in the beginning to socially disparate and fragmented communities that the later theology and its unifying mandala could not overcome – even with the construction of the Matrimandir ... Not only did the vision undergirding Auroville contain fatal flaws which hindered horizontal community building, but the individualistic expression and appeal of that utopian dream has hastened its undoing.³⁷

Much as then, there is a marked absence today of a centralized political / administrative, social or economic ordering, that could bind the unit together – in result, decentralization has tended to dissipation in terms of collective visioning and action, with a majority of initiatives driven by individual enterprise outside of a cohesive or planned policy framework. The upward movement – from the political to vital and mental – is distinct, if haltering and yet incomplete, yet the horizontal movement to effective unification, something to bind the residents in a *communitas*, is weak.

This is the case at various levels. Spatially, this is why the urban sprawl today, leapfrogging the city into outlying lands where a quarter of the population resides, requires urgent reconsideration as we suggested in Part III.D. For the 'ideal of human unity' to emerge, a common habitation in close quarters is central. Dispersion and distance hamper the process of effective unification. Economically, a coordinated approach amongst the hitherto loosely organized units / trusts / firms, with dynamic clustering presents a challenge to effective unification, as we discussed in Part III.F. And culturally, the development of a cohesive public sphere, which we discuss below, is necessary for a common social fabric to emerge and counter tendencies towards 'echo chambers'. Unsurprisingly, a major *situs* for disagreement in this period from 2001-2023 has been city-planning, as it embodies the spatial dynamic of the centralizing tendency in the collective yoga, at the vital, mental and subjective levels. Why urban planning is so important is because the development of physical and social infrastructure is the expression of a common, unified will, that demands a certain centralization for its effective manifestation at a city-wide scale that no single group can accomplish in the culture of small-group formation, each seeking to regulate its own domain.

We can observe this progression if we trace, albeit superficially, the evolutionary scheme in Sri Aurobindo's *Ideal of Human Unity*: Chapters XIX, XX, XXI speak of the 'drive towards

³⁷ Shinn, 1984, 243-7, 249, 252-3.

centralization and uniformity of administration’, intertwined with the physical territory, the ‘drive towards economic centralization’ and finally, the ‘drive towards legislative and social centralization and uniformity.’ Chapters XXII to XXVII then detail the conflicting movements of centralization and variation, ending in Chapter XXVIII, ‘Diversity in Oneness’, which attempts a reconciliation of the two. Placing this in the Auroville context, the movement to centralize – a collectivist imagination in which individuals locate themselves in the whole, the horizontal *communitas* – is yet weak. Sri Aurobindo’s following remark applies to the empirical context of Auroville today, with much work yet to be done on all levels of unification, geographical, administrative, social and psychological:

If we consider the actual state ... its immediate possibilities, we shall see that a first period of loose formation and imperfect order is inevitable. Neither the intellectual preparation of the human race nor the development of its sentiments nor the economic and political forces and conditions by which it is moved and preoccupied have reached to such a point of inner stress or external pressure as would warrant us in expecting a total change of the basis of our life or the establishment of a complete or a real unity. There cannot as yet be even a real external unity, far less a psychological oneness.³⁸

It would take further examination to verify this claim, but it appears that much of the resistance relates to the strong imprint of the early years of a vital subjectivism, with a resulting denial of centralized (legitimate) authority. This is particularly necessary and required today in Auroville. This movement can be studied from four perspectives. The first is the move from organicity to rationalization to develop a regulatory architecture. The second is the development of clusters, sub-cultures or federated forms of organization. The third is the question of the construction of authority in centralized modes of organization, in the form of Working Groups and a strong Residents’ Assembly. And the fourth is the inner movement towards psychological oneness or fraternity, as the spiritual cement that ties together all residents. We briefly address each in turn.

iv. Movement from the Outer to Inner: the ‘Z’ Axis

There is, as it were, a non-cartesian dynamic to governance in Auroville, a measurement of inner depth, that is as necessary as it is ineffable: its spiritual dimension. This is the axes along which solidarity and fraternity emerge – from outer, geographic to inner, psychological oneness – and bind the community into a whole through creative conflict or collaboration. This inward, subjective turn represents itself variously:

- i. From early customary codes, developed ‘organically’ to a conscious rationalization, constraining if intrusive and enabling if flexible and illumined.
- ii. From early separateness to growing unity, through intermediate forms of federated organizations, the discovery of ‘group-souls’ within the collective.

³⁸ Sri Aurobindo, CWSA, 1997, Vol. 25, 384-5.

- iii. The early democratic flush, with *rajasic* conflict – manifesting as an assertion of participatory equality or (disguised) oligarchy – to a disciplined, spiritual anarchism, assisted by an interim organization along the principle of ‘illuminated hierarchies with collective discipline’. The question of Auroville’s ideal social contract.

We address these in turn.

a. From Early Organicity to Intelligent Rationalization: the Regulatory and Professional Turn

The early stages of Auroville witnessed, as one would expect, a mass of unwritten customary codes across sectors responding to the developing circumstances of the time. The transition from customary law, with habits acquiring a sense of bindingness, *opinio juris*, to codified rules is characteristic of the evolution of regulatory systems.³⁹ The emergence of codes of conduct, policies and regulations from the late 80s onwards reflect this shift. Sri Aurobindo outlines this movement, from organic customary codes to intelligent systematization, accompanied with a collectivist turn to centralized political authority:

In its beginnings, law is always customary and where it is freely customary, where, that is to say, it merely expresses the social habits of the people, it must, except in small societies, naturally lead to or permit considerable variety of custom ... This spontaneous freedom of variation is the surviving sign of a former natural or organic life of society as opposed to an intellectually ordered, rationalised or mechanised living. The organic group-life fixed its general lines and particular divergences by the general sense and instinct or intuition of the group-life rather than by the stricter structure of the reason.

The first marked sign of a rational evolution is the tendency of code and constitution to prevail over custom. For first there are systems that are unwritten or only partly written and do not throw themselves into the strict code form, but are a floating mass of laws, *decreta*, precedents, and admit still of a large amount of merely customary law. And again there are systems that do take the strict code form, like the Hindu Shashtra, but are really only an ossification of custom and help to stereotype the life of the society but not to rationalise it. Finally there are those deliberately ordered codes which are an attempt at intelligent systematisation; a sovereign authority fixes the *cadres* of the law and admits from time to time changes that are intelligent accommodations to new needs, variations that do not disturb but merely modify and develop the intelligent unity and reasonable fixity of the system. The coming to perfection of this last type is the triumph of the narrower but more self-conscious and self-helpful rational over the larger but vaguer and more helpless life-instinct in the society. When it has arrived at this triumph of a perfectly self-conscious and systematically rational determination and arrangement of its life on one side by a fixed and uniform constitution, on the other by a uniform and intelligently structural civil and criminal law, the society is ready for the second stage of its development. It can undertake the self-conscious, uniform ordering of its whole life in the light of the reason which is the principle of modern socialism and has been the drift of all the Utopias of the thinkers.⁴⁰

³⁹ See, in general, Bederman, 2010.

⁴⁰ Sri Aurobindo, CWSA, 1997, Vol. 25, 354-5.

This movement to self-conscious, systematic regulation and determination has begun in patches but yet be undertaken in Auroville. Two reasons possibly explain this. The first is the preference for organicity, which is popularly opposed to rigid codification, whereas in reality its proper opposite number is not an ossification of custom but an intelligent and alert rationalization necessary for a conscious self-regulation of the whole. The second that this rationalization requires an identification of a central legislative authority, either a democratic assembly or as is more likely at scale, a representative institution or executive minority with expertise over the domain. This step, natural and inevitable, has been delayed through an autarchic and loose social organization resistant to centralization. ‘Freedom’, so understood, translates to a dissipated and complex mass of customary habits in which efficient and ordered action – the centralizing, rationalizing turn – particularly in relation to the complex task of city-building, is unlikely. Further, substitution of the ‘state’, the Residents’ Assembly and Working Groups, for the natural organic society – an advance to true self-regulation – appears to have been resisted. Sri Aurobindo explains this transition, necessary for Auroville today:

At first, in the early stage of society, there is no such thing as what we understand by law, the Roman *lex*; there are only a mass of binding habits, *nomoi*, *mores*, *ācāra*, determined by the inner nature of the group-man and according to the action upon it of the forces and the necessities of his environment. They become *instituta*, things that acquire a fixed and formal status, institutions, and crystallise into laws ...

This complex customary law evolved indeed, but by a natural development of the body of social habits in obedience to changing ideas and more and more complex necessities. There was no single and fixed legislative authority to determine them by conscious shaping and selection or in anticipation of popular consent or by direct ideative action upon the general consensus of need and opinion ...

This rational development consists, as we have seen, in the creation of a central authority, at first a distinct central force but afterwards more and more conterminous with the society itself or directly representing it, which gradually takes over the specialised and separated parts of the social activity.

All that may be suprarational or, if you will, irrational, but it represents a different stage of human development from the government of society by its rational and practical mind which in contact with life’s changing needs and permanent necessities demands a created and codified law determined by a fixed legislative authority, the society’s organised brain or centre. They are the sign that the society is getting ready to be an entirely self-conscious and therefore a freely and consciously self-regulating organism.⁴¹

This rational development of the ‘state’, through a firmly and intelligently organized Residents’ Assembly, far from the case currently, will be accompanied by ‘a distinct central force which gradually takes over the specialised and separated parts of the social activity’, i.e., the Working Groups. The weakly defined powers of the Working Groups, however, has made this advance a slow and laborious process in the making. Indeed, one witnesses an interesting and all-important shift in the 2000s – with the physical base secured, the shift to the ‘city’ demanded amongst other things a centralized planning office manned by a ‘cadre’ of professionally

⁴¹ Sri Aurobindo, CWSA, 1997, Vol. 25, 446-9.

trained Aurovilians. This need for professionalism and centralized planning amidst the ‘free’ and semi-autarchic sub-systems demanded a cultural shift, one yet to be made in Auroville: the need for ‘rationalisation’. The records from 2001 onwards are replete with these suggestions along these lines – for example, the 2003 Directions for Growth Report, written by the only professionally trained urban planner in Auroville at the time, is a good example:

The construction of the Centre for Urban Research (Town Hall Annex) as a part of the project has given an impetus to consolidating the efforts in planning and development made by Auroville earlier, and give it an opportunity to march forward to the achievement of the next levels of the planned township. The plan provides a strong foundation for starting to build the city in a systematic, professional and humane way.⁴²

This move proposed, in some measure at least, an introduction of formal bureaucratic rationality in Auroville’s hitherto ‘free’, small-group / customary, community-driven forms of collective action – a link between authority and professional knowledge, an increasingly quantitative technocratic rationality, with standardization of codes and policies, a tension between communal, customary modes of organization with bureaucratic efficiency etc. This dynamic, discussed at length in the literature, has been a persistent fault-line in Auroville’s organizational dialogue – it is, in a sense, unsurprising that the ‘rejection of the ordinary’ carries rhetorical currency in Auroville, including as of today, in relation to commercial, planning and organizational matters, where the nub of the ‘rejection’ of the 70s and 80s lay. The early migrations were in large part a *reaction* to the excessive ‘rationalization’ of the public sphere, particularly with those from the ‘West’, looking to escape the cramping effects of the efficient, managed and ordered conventions, ‘an oppressive cramping of his expansion, a denial of breathing-space and elbow-room.’⁴³

It is an interesting sociological exercise, one that we can only point to here, to map Auroville’s governance trajectory in this vital-mental phase, in Sri Aurobindo’s articulation, to the literature on the rationalization (bureaucratization / professionalization) of the public sphere. This is particularly in relation to the shift from rational to supra-rational forms of collective ordering risking, absent a sufficiently strong rational development, a lapse into vital subjectivism. Bureaucratic or professional ordering – embodying a means-end instrumentality through careful planning, *techné* – is characteristic of the rationalization of the public sphere, the ‘age of reason’. Townley, for example, relates the rise of bureaucratic technocracies to the rationalization movement, a defining feature of the modern state:

Bureaucracy is ... ‘the most rational known means of exercising authority over human beings’ and as such capable of the ‘highest degree of efficiency’ ... The choice in organizing administration is between ‘bureaucracy’ and ‘dilettantism’.

On one level, organization studies may be understood as the working through in theoretical and practical terms of the dimensions of rationality; organizations as a conceptual and material space within which various dimensions and facets of reason

⁴² Directions for Growth, 2003, 38.

⁴³ Sri Aurobindo, CWSA, 1997, Vol. 25, 160, 624.

and rationality are worked out in theories and in practice alongside and through the organization of production.⁴⁴

‘Structure’ is the means whereby organizations can achieve bounded rationality, for the rationality of structure is the means of ensuring the rationality of individuals. ‘The organization permits problem subdivision, simplifies choices, channels information and restricts alternatives’. Individuals behave rationally because structure limits choice and circumscribes behaviour. Control requires a rational structure of restricted discretion and centralized decision-making.⁴⁵

It is thus interesting to ask whether Auroville’s governance complaints owes to an excess of collective rationality, embodied in centralized Working Groups, or a deficit of it? One way to answer this question would be to examine the competence, qualifications and professionalism of Working Groups – of the quality and effectiveness of action as against defined benchmarks. In this measure, much is yet to be done. While the bureaucratic dispensation has a ‘dark side’, one that Auroville must pay heed to as it matures its regulatory setup, the state of affairs currently leans heavily in favour of the need for rationalization of spheres of common action through selection processes that induct professional, domain experts with strong executive powers.⁴⁶ Sri Aurobindo, on his part, recognizes the value of this rationalizing movement as a preparatory step:

The rational collectivist idea of society has at first sight a powerful attraction. The right organisation of social life on a basis of equality and comradeship ought to give each man his proper place in society, his full training and development for the common ends, his due share of work, leisure and reward, the right value of his life in relation to the collective being, society. Moreover it would be a place, share, value regulated by the individual and collective good and not an exaggerated or a depressed value brought to him fortuitously by birth or fortune, purchased by wealth or won by a painful and wasteful struggle. And certainly the external efficiency of the community, the measured, ordered and economical working of its life, its power for production and general well-being must enormously increase, as even the quite imperfect development of collective action in the recent past has shown, in a well-organised and concentrated State.

The spirit of the centralisation will be a strong unitarian idea and the principle of uniformity enforced for the greatest practical convenience and the result a rationalised mechanism of human life and activities throughout the world with justice, universal well-being, economy of effort and scientific efficiency as its principal objects. Instead of the individual activities of nation-groups each working for itself with the maximum friction and waste and conflict, there will be an effort at coordination such as we now see in a well-organised modern State.

...

⁴⁴ Townley, 46, 7, 22, 48, 49, 51.

⁴⁵ There is an important discussion that must follow here, of the potential and well-known dysfunction of bureaucracies, which we do not address here. On a broader note, the rationalization process far exceeds the institutional mechanisms and bureaucracies, into philosophy, arts, sciences, legal systems etc. It is a fascinating question to see how the evolution of knowledge systems and material expression in Auroville evolves.

⁴⁶ See, for example, Gay, 2006.

A great number of outstanding problems would be solved by the united intelligence of mankind working no longer in fragments but as one. The vital life of the race would settle down into an assured rational order comfortable, well-regulated, well-informed, with a satisfactory machinery for meeting all difficulties, exigencies and problems with the least possible friction, disturbance and mere uncertainty of adventure and peril. ... Men would meet each other much more closely and completely than before, develop a greater mutual understanding rid of many accidental motives of strife, hatred and repugnance which now exist, and arrive, if not at brotherhood, — which cannot come by mere political, social and cultural union, — yet at some imitation of it, a sufficiently kindly association and interchange.⁴⁷

This ‘external efficiency’ and ‘kindly association and interchange’ – with an increase in the power of production and general well-being – is precisely what the raft of planning and policy work from 2001 Masterplan onwards represents, discussed sector-wise in our overview in Part III: the search in Auroville for a careful, scientific and ordered approach to city-building. The focus on data collection, quantitative measurements, attempts at organization of the collective to solve coordination problems, driven by expertise / professionals stands in apparent contrast to the imprint of (at times, rather vague) subjectivism of the community – the former pushes for an efficient, ‘well-ordered’ and ‘planned’ mechanism for development, the latter rejects it for an ‘organic’, free play wary of a technocratic takeover or a regulatory cramping. Taken to the extreme, Sri Aurobindo articulates this dynamic, of a creeping growth of legislative and executive centralized authority:

Whatever authority were established, if it is to be a true authority in any degree and not a mere concert for palaver, would find itself called upon to act more and more frequently and to assume always increasing powers.

This legislative power, as it developed, extended, regularised its action, powers and processes, would become more complex and would be bound to interfere at many points and override or substitute its own for the separate national action.... And eventually it would permeate the whole system of ... life and subject it to ... control in the interests of the better coordination of the united life, culture ... [Yet the] State principle leads necessarily to uniformity, regulation, mechanisation ... For if an excessive uniformity and centralisation tends to the disappearance of necessary variations and indispensable liberties, a vigorous diversity and strong group-individualism may lead to an incurable persistence or constant return of the old separatism which will prevent human unity from reaching completeness or even will not allow it to take firm root.

Instead of a hierarchical arrangement of classes each with its powers, privileges and duties there will be established an initial equality of education and opportunity, ultimately perhaps with a subsequent determination of function by experts who shall know us better than ourselves and choose for us our work and quality ... Thus we should have a new typical order based upon purely economic capacity and function, *guna karma*, and rapidly petrifying by the inhibition of individual liberty into a system of rationalistic conventions. And quite certainly this static order would at long

⁴⁷ Sri Aurobindo, CWSA, 1997, Vol. 25, 497, 507. Sri Aurobindo ends this passage on a different note, pointing to the self-defeating excesses of organization in stagnation (‘The soul of man would begin to wither in the midst of his acquisitions.’). This is an important caution, as we saw in relation to the 2017 Code of Conduct, yet some distance away in general in Auroville’s current setup.

last be broken by a new individualist age of revolt, led probably by the principles of an extreme philosophical Anarchism.⁴⁸

Auroville is far from this stage of ‘thoroughgoing rationalization’; indeed, it is closer to the other extreme currently and requires a strong rationalization of its common works, though mindful of the dangers of taking that collectivist rational tendency too far.

In the sociology of things, it appears that the call for a professional ordering, a rationalization of the collective processes, necessary and needed for the systematic and ordered growth of the city – the key push of the Masterplan – was met with a resistance. In some ways, this was expected: the free play and adventure promised by the barren land and the works of environmental regeneration – still manifested in the creative disciplines of architecture, education and others, where Auroville offered space and freedom to aspiring professionals, with a sparsely populated land and little by way of regulatory limitations – was now met with an inevitable organizational, ‘mental’ push to manifest the urban space. What followed, it appears, was a partial resistance to centralization, technocratic planning and professionally driven ‘bureaucracies’.

As records across the board indicate, the question the community asked itself was, ‘are we not here to go beyond the mind?’ Put in other words, ‘are we not here to go beyond the collectivist rationalism represented in bureaucratic centralization?’ Yet, as the rejuvenated physical landscape now did not offer that free play and began to place limits on vital subjectivism, Auroville arrived at an impasse. Alongside, the changing profiles of new residents around the turn of the millennium, reflected the changed aspirations of residents (many Indians, whose numbers grew in relative terms) post liberalization – these new residents were confronted no longer with a barren, challenging landscape, but a relatively comfortable one; the incentive structure were now altered, but they too were looking to find something ‘different’ from the clustered city environment and the professionally-ordered, ‘hierarchical’ arrangements of life elsewhere. The natural flagging of vital energies born of rational control, no longer with space to unhindered expression led to a creative inertia, a ‘stagnant harmony’, with an accompanying insularity, flushed with rejections of the urban and a recall of the ‘rationalist’ crises elsewhere, yet without a clear pathway to the new. In this, calls for increasing densities, building the ‘city’, developing infrastructure etc. brought back fears of that which was sought to be escaped – the very spatial challenges that Mother’s account of spiritual urbanism in Auroville was meant to take on and address.

The negative motivation – what the community did not want – is clearly articulated, yet the positive one – what it can aspire to – lacks specificity, with records from the time replete with abstract calls to meet and embody the spiritual purpose of Auroville, yet without concrete specifications, plans for implementation, time-targets or performance benchmarks. Each of these carried the flavour of a ‘cramping rationality’ and non-spontaneity, discussed in Part I as the negative push of the world that pulled many to Auroville. Characteristic of records from the time is the apparent contrast between ‘organicity’ and ‘planning’, the former ‘spiritual’ and ‘free’ and the latter ‘rational’ and ‘unfree’, resulting in unsystematic and *ad hoc* development

⁴⁸ Sri Aurobindo, CWSA, 1997, Vol. 25, 494, 496, 505, 520, 22.

– this dynamic is clear in urban infrastructure development, housing and economic development, with professional interventions in the fields rarely translating into systematic work plans. In Mother and Sri Aurobindo’s schema, a rejection of rational ordering resulted, in what appeared to be well-intentioned but dangerous, and ultimately, sterile, attempts at leapfrogging the ordered development of the rational and vital parts of the collective being into an ordered, true subjectivism.

In this dynamic movement, the question – in Mother’s and Sri Aurobindo’s scheme – was whether Auroville was to move down, to a false vital subjectivism, a reasonable criticism of many of the current setup, or move up, to a true spiritual subjectivism. Or, indeed, hover uncertainly around a loose rational ordering, with a mass of occasional vital rushes and spiritual flashes, yet uncertain and undecisive. Having provisionally rejected rational ordering at least at the rhetorical level, the mystique yet not the substance of subjectivism currently seems to prevail in Auroville.

In this, as one would expect in Sri Aurobindo’s scheme, the collective and individual tendencies, those to centralization and decentralization, appeal with equal force – to strengthen Working Groups, Zonal Bodies and better organize the Residents’ Assembly, for systematic, cohesive action with Detailed Development Plans for the city and each sector, on one hand, or greater space for individual and group initiative to operate independently, with free play in a loosely articulated collective scheme, on the other – all overlaid with emotive calls for ‘anarchism’, understood as a spontaneous and unregulated exchange of individuals mingling in a collective, yet for which the prior preparatory work of rational and vital purification, the ‘inner discipline’ Mother referred to as the pathway to the ‘Divine anarchy’, yet unripe.

We may hazard to say that the early subjectivism, dovetailing with the sparse land and the promise of the early years, still left the vital and rational ordering of the ‘age of reason’ to be worked out in its fullness, from which emerges naturally a spiritual ordering. It is this task, necessary for the integral movement of the collective in the collective yoga, that presented itself in the late 80s onwards with the vital and mental push and is yet continuing slowly, reluctantly. As we discussed in Part I, the premature rejection of mentality opens the door to a dangerous intermediate phase, to which Auroville is by no means exempt:

The result is likely to be rather the creation of a tenebrous No Man’s Land where obscure mysticisms, materialistic, vitalistic or mixed, clash and battle for the mastery of human life. But this consummation is not certain; chaos and confusion still reign and all hangs in the balance.⁴⁹

Organizationally speaking, what this translates to if one rejects expertise, led professional orderings is the following question:

The question remains whether anarchistic thought supervening upon the collectivistic can any more successfully be a satisfying social principle. For if it gets rid of mechanism, the one practical means of a rationalising organisation of life, on what will it build and with what can it create?⁵⁰

⁴⁹ Sri Aurobindo, CWSA, 1997, Vol. 25, 206.

⁵⁰ Sri Aurobindo, CWSA, 1997, Vol. 25, 215.

There is a danger here on many counts for Auroville. The first is an attempt to leapfrog a collective rationality – for all its limitations, one must recognize the ‘great and visible new benefits of order, economic development, means of efficiency and the scientific satisfaction of the reason which the collectivist arrangement of society will bring.’ The thrust for professionalism, efficient ordering in urban development, housing, economy, agriculture etc. – reflected in our overview in Part III from the late 80s onwards, with various plans and proposals – was tied to the need to secure a collective tightening of the nuts and bolts of organized action. This rationalization is a necessary and valuable part of Auroville’s evolutionary cycle, which neither can be nor ought to be avoided. A careful, ordered rationalization of the spheres of common action – the domination of life by knowledge, through reason – led by technical and professional expertise prepares the ground for an illumination of the collective to spiritual states. This stage is yet to be crossed, or indeed attempted in its earnest, in Auroville, with a dominant, yet vague, subjectivism resisting the rigors of organization, much to the frustration of the professional classes in the city. It is interesting that the first definition of collective life in Auroville, drafted by Anger and approved by Mother, for Aspiration spoke of moving to a ‘higher consciousness’, yet insisted on the need for ‘a rigorous inner discipline’:

Aspiration is the embryo of Auromodèle, therefore of Auroville, and should represent both internally and externally the ideal of Auroville. Internally, everyone should seek an inner progress and the higher consciousness; the first necessity is a rigorous inner discipline. Externally, Aspiration should be a model of cleanliness, ideal living, and order freely chosen and self-imposed, and productive activities. The time has come for Aspiration to prove its existence and its aptitude to organise itself. The tasks to be accomplished in the current life should be defined and assigned.⁵¹

Similarly, Sri Aurobindo notes that the ‘ideal condition’ for a true subjectivism is a sufficiently diffused rationality amongst the collective:

Ideal conditions cannot be expected, for they demand a psychological clarity, a diffused reasonableness and scientific intelligence and, above all, a moral elevation and rectitude to which neither the mass of mankind nor its leaders and rulers have yet made any approach. In their absence, not reason and justice and mutual kindliness, but the trend of forces and their practical and legal adjustment must determine the working out of this as of other problems.⁵²

To attempt the ideal of the ‘spiritual anarchist’ requires the substitution of outer, collective restraints born of a thoroughgoing rationalism with an even more demanding inner discipline – to reject the former without the latter is to insist on growing without a mould, a recipe for disorder or dilettantism in the name of something higher. Mother makes this explicit:

[Q: Must one allow individual initiative to manifest and inspiration and intuition to be the moving force behind personal action, and should one reject all ideas not felt good by the interested party?] In order to be workable, this requires all workers of Auroville to be yogis conscious of the Divine Truth.⁵³

⁵¹ Guigan, 2018, Vol. 2, 194, 197.

⁵² Sri Aurobindo, CWSA, 1997, Vol. 25, 396.

⁵³ Guigan, 2018, Vol. 1, 328.

And Sri Aurobindo pungently puts it this way:

The anarchic is the true divine state of man in the end as in the beginning; but in between it would lead us straight to the devil and his kingdom.⁵⁴

If a rational ordering is to be replaced, as it must be in the evolutionary scheme of things – ‘[at] bottom, the problem almost boils down to this: to replace the mental government of intelligence by the government of a spiritualised consciousness’ – then the foundation of rational ordering must be secured first. If the ground is not firm, the jump, no matter how enthusiastic, will fall short. In time, naturally, the collectivist regulatory frames attempting this exercise (say, for example, the 2017 Code of Conduct) will come in dynamic tension with the demand for free play and variation, in which will *naturally* emerge the ground for a true subjectivism – this ‘ideal law of social development’, a synthesis of the two tendencies, will depend on a progressive and ordered widening of the rational faculty expressed in the necessary ‘bureaucratic’ ordering of the Working Groups and an accompanying vital purification.

A conflation of the instinctive, infra-rational spontaneity of the life-mind and the intuitive spontaneity of the supra-rational places is to be guarded against here. The intermediate link between them is critical to establish governance frames through a rational ordering, represented in the centralizing move to plan, coordinate and regulate. Indeed, one may view Mother’s 1965 Ford Foundation letter in this spirit. The transition from the mental to the intuitive substance, which Sri Aurobindo details in his *Synthesis of Yoga*, requires the collective to ‘develop [its] intellect instead of eliminating it’, such that ‘greater their development, the richer the preparation for the supramental action’. The rungs of the ‘world-stair’, if one uses a metaphor from *Savitri*, cannot be jumped, as was sometimes the inarticulate premise of calls for ‘organic’ development in our interviews:

A fourth method is one which suggests itself naturally to the developed intelligence and suits the thinking man. This is to develop our intellect instead of eliminating it, but with the will not to cherish its limitations, but to heighten its capacity, light, intensity, degree and force of activity until it borders on the thing that transcends it and can easily be taken up and transformed into that higher conscious action. This movement also is founded on the truth of our nature and enters into the course and movement of the complete Yoga of self-perfection. That course, as I have described it, included a heightening and greatening of the action of our natural instruments and powers till they constitute in their purity and essential completeness a preparatory perfection of the present normal movement of the Shakti that acts in us. The reason and intelligent will, the buddhi, is the greatest of these powers and instruments, the natural leader of the rest in the developed human being, the most capable of aiding the development of the others. The ordinary activities of our nature are all of them of use for the greater perfection we seek, are meant to be turned into material for them, and the greater their development, the richer the preparation for the supramental action.⁵⁵

To the extent this inner purification is obtained, the self-existent luminosity and clarity of being, the spontaneity of the anarchist ideal will emerge – an effortless play of communal harmony

⁵⁴ Sri Aurobindo, CWSA, 1997, Vol. 12, 465.

⁵⁵ Sri Aurobindo, CWSA, 1997, Vols. 23-24, 806.

arrives as result of a long and disciplined effort of vital and mental purification, not a loose autarchic ordering. And this ideal is ‘hardly [possible] without a considerable change and progress in man’s mental powers’:

... But it is at the same time clear that the more the outer law is replaced by an inner law, the nearer man will draw to his true and natural perfection. And the perfect social state must be one in which governmental compulsion is abolished and man is able to live with his fellow-man by free agreement and cooperation. But by what means is he to be made ready for this great and difficult consummation? Intellectual anarchism relies on two powers in the human being of which the first is the enlightenment of his reason; the mind of man, enlightened, will claim freedom for itself, but will equally recognise the same right in others. A just equation will of itself emerge on the ground of a true, self-found and unperverted human nature. This might conceivably be sufficient, although hardly without a considerable change and progress in man’s mental powers.⁵⁶

In sum, what is thus required now is an intelligent rationalization, backed by a firm yet sensible centralization of the legislative working of the Residents’ Assembly and a specialized, professional organization of the Working Groups, leading to a smart and flexible regulatory framework looking to avoid the excesses of democratic delay, bureaucratic capture and regulatory stunting of individual enterprise, respectively. The plethora of proposed plans and policies for common action proposed across sectors discussed in Part III, yet not agreed-upon or implemented, offer good reasons for this centralizing corrective for collective energies to be harnessed for a *collective* vision to emerge backed by professional implementation, rather than a patchwork of individual initiative:

Instead of the individual activities of ... groups each working for itself with the maximum of friction and waste and conflict, there will be an effort at coordination such as we now see in a well-organised modern State ... The spirit of the centralisation will be a strong unitarian idea and the principle of uniformity enforced for the greatest practical convenience and the result a rationalised mechanism of human life and activities throughout the world with justice, universal well-being, economy of effort and scientific efficiency as its principal objects.

...

So far the aim in modern socialism is right and good. But all unnecessary interference with the freedom of man’s growth is or can be harmful.⁵⁷

The fears of collectivist excess are proper – of a ‘mechanistic’, rules-based order that often accompanies this rationalizing movement and unduly hinders individual freedom. They are part of the urban governance challenge that Auroville must navigate – a flourishing literature on ‘smart’, ‘responsive’, ‘adaptive’ regulation, ‘post-bureaucratic organization’ and a range of innovative policy tools outside of the hard enforcement of rules in the ‘command’ mode presents fertile ground for Auroville to study in designing its own regulatory architecture.⁵⁸

⁵⁶ Sri Aurobindo, CWSA, 1997, Vol. 25, 217.

⁵⁷ Sri Aurobindo, CWSA, 1997, Vol. 25, 301, 497.

⁵⁸ See, in general, Baldwin et. al. (eds.), 2010; Gunningham and Sinclair, 1998; Baldwin et. al. (eds.), 2012; Gossum et. al. 2010.

This step, one yet to be taken in Auroville, ‘enables the society at last to perfect consciously by means of the State the whole organization of its life’ – it is ‘the sign that the society is getting ready to be an entirely self-conscious and therefore a freely and consciously self-regulating organism.’ Our proposals in Sections B, C and D below are oriented to this end. If a city of the ambition of Auroville is to be built, this move is both urgent and necessary. The early stage of loosely defined customary practices, within small group-settings, has to mature in an intelligent and in time, illumined, collective rationalization. In the spirit of concentrated evolution, this movement, one would hope, is hastened, contrary to the rather slow and piecemeal trend since 2001.

b. Federated Organization, Public Spaces and ‘Group-Souls’

In building the link between the individual and the community, for the progressive universalization of the self, Sri Aurobindo outlines the necessity of identification with smaller aggregates for step-wise ascension:

The administrative, political, economic organisation of mankind in aggregates of smaller or greater size is a work which belongs at its basis to the same order of phenomena as the creation of vital organisms in physical Nature. It uses, that is to say, primarily external and physical methods governed by the principles of physical life-energy intent on the creation of living forms, although its inner object is to deliver, to manifest and to bring into secure working a supraphysical, a psychological principle latent behind the operations of the life and the body. To build a strong and durable body and vital functioning for a distinct, powerful, well-centred and well-diffused corporate ego is its whole aim and method. In this process, as we have seen, first smaller distinct units in a larger loose unity are formed; these have a strong psychological existence and a well-developed body and vital functioning, but in the larger mass the psychological sense and the vital energy are present but unorganised and without power of definite functioning, and the body is a fluid quantity or a half-nebulous or at most a half-fluid, half-solidified mass, plasm rather than a body. This has in its turn to be formed and organised; a firm physical shape has to be made for it, a well-defined vital functioning and a clear psychological reality, self-consciousness and mental will-to-be.

Thus a new larger unity is formed; and this again finds itself among a number of similar unities which it looks on first as hostile and quite different from itself, then enters into a sort of community in difference with them, till again we find repeated the original phenomenon of a number of smaller distinct units in a wider loose unity. The contained units are larger and more complex than before, the containing unity is also larger and more complex than before, but the essential position is the same and a similar problem presents itself for solution.⁵⁹

What this translates into – in terms of practical organizational forms for Auroville – is the necessity for a firm sub-zonal architecture to allow for well-defined collectives to emerge, each with its distinct identity and devolved powers.⁶⁰ This architecture lends itself to a networked

⁵⁹ Sri Aurobindo, CWSA, 1997, Vol. 25, 301, 366-7.

⁶⁰ See, for example, benefits of such a process when instituted, Report of TDC, January to May, 2015, 11-2. Following a presentation by the architect for Kalpana and feedback from the community in that area, not as a

organization of sub-zonal federation, with each sub-zonal unit regulating its own activity and a growing interchange with neighbouring units. In the Residential Zone, this translates to a centripetal mixing of diverse lives, each resident participating, from greater to lesser intensity, at the level of the neighbourhood, community, ward, sector and Zone as a whole; in the Cultural Zone, a centripetal mixing of researchers, artists, teachers and learners across disciplines of learning, organized in research or schooling clusters; in the International Zone, a centripetal mixing of national-groups / pavilions and continental clusters in a vision of rooted cosmopolitanism; in the Industrial Zone, a firm organization of professional clusters. These sub-zonal bodies – however the architecture is thought-up – act as units which engender daily interchange and activity, allowing for a sense of belonging and identification at the local level. An institutional form to facilitate the emergence of ‘group-souls’, progressively merging into the whole. This federated organization serves four distinct purposes:

- i. It allows for solidarity and social cohesion to emerge through sub-zonal identification, providing an institutional form for the substance of fraternity to develop.
- ii. It engages clustering dynamics, by facilitating robust interchange in those defined collectives, whether in terms of residential, research, cultural or productive life.
- iii. This institutional form can be tied to formal decision-making governance frames, with city-planning work / preparation of Zonal Detailed Development Plans partially devolved to these decentralized collectives for engaged and participatory devolution of powers along the principle of subsidiarity.
- iv. It allows for meaningful, effective and accountable participation in local matters, where information is relatively more accessible, one’s voice can truly matter, consensus building is easier and participatory filibustering or blockages can be addressed effectively.

Placing this in the context of Sri Aurobindo’s discussion, our proposal for a confederated, networked organization for governance in Auroville stems from the need to harmonize the twin concerns of centralization and decentralization discussed above. This organization must be backed by a series of *public spaces* – a term we consider in Section E below – that act as necessary cultural supports for this institutional form, centripetal forces for smaller collectives to gather and effectively self-organize. Culture grounds institutional working, absent which a divide between formal governance practices and on-ground ways of life, a marked divide in Auroville, will continue to persist. A brief reflection on how this arrangement relates to Sri Aurobindo’s thought, as also allied thinkers, is useful to explain the thinking behind our proposal. We offer an outline here, which may be examined in future research.

whole in the Residents’ Assembly, the TDC recorded that meaningful discussions were had. A separate portal for each project / community, proposed at the time, can be incorporated in the Governing Dashboard suggested below for effective and easy participation.

This confederation of ‘mini-publics’ can generate a kind of zonal or sub-zonal identification, which may assist in the development of distinct and diverse identities at the level of neighbourhoods, work associations, cultural links and national ties across the four zones that can foster a sense of belonging and solidarity within *smaller* collectives.⁶¹ Each sub-zonal grouping can have its distinct way of life, temperaments, characteristic modes of expression, sharing a porous boundary with others, coalescing in time to a unified whole. This architecture of the public space informed Mother’s early conceptualization of the city, reflecting Sri Aurobindo’s discussion in the *Ideal of Human Unity*:

Individual man belongs not only to humanity in general, his nature is not only a variation of human nature in general, but he belongs also to his race-type, his class-type, his mental, vital, physical, spiritual type in which he resembles some, differs from others. According to these affinities he tends to group himself in ... communities, ... coteries, associations whose life he helps, and by them he enriches the life of the large economic, social and political group or society to which he belongs. In modern times this society is the nation. By his enrichment of the national life, though not in that way only, he helps the total life of humanity. But it must be noted that he is not limited and cannot be limited by any of these groupings; he is not merely the noble, merchant, warrior, priest, scholar, artist, cultivator or artisan, not merely the religionist or the worldling or the politician. Nor can he be limited by his nationality; he is not merely the Englishman or the Frenchman, the Japanese or the Indian; if by a part of himself he belongs to the nation, by another he exceeds it and belongs to humanity. And even there is a part of him, the greatest, which is not limited by humanity; he belongs by it to God and to the world of all beings and to the godheads of the future. He has indeed the tendency of self-limitation and subjection to his environment and group, but he has also the equally necessary tendency of expansion and transcendence of environment and groupings ... the community stands as a mid-term and intermediary value between the individual and humanity and it exists not merely for itself, but for the one and the other and to help them to fulfil each other. The individual has to live in humanity as well as humanity in the individual; but mankind is or has been too large an aggregate to make this mutuality a thing intimate and powerfully felt in the ordinary mind of the race, and even if humanity becomes a manageable unit of life, intermediate groups and aggregates must still exist for the purpose of mass-differentiation and the concentration and combination of varying tendencies in the total human aggregate. Therefore the community has to stand for a time to the individual for humanity even at the cost of standing between him and it and limiting the reach of his universality and the wideness of his sympathies.

But hitherto the experience of mankind has not favoured the view that huge aggregations, closely united and strictly organised, are favourable to a rich and puissant human life. It would seem rather that collective life is more at ease with itself, more genial, varied, fruitful when it can concentrate itself in small spaces and simpler organisms.⁶²

The universalization of identification in Sri Aurobindo’s thought proceeds progressively through these smaller moulds, given our cognitive grasp and motivations to action in relation

⁶¹ For an interesting take on resilience in complex systems, mini-publics being one design solution, *see*, Eliassi-Rad et. al., 2020. For the value of a well-articulated public sphere, *see*, De Angelis, 2021.

⁶² Sri Aurobindo, CWSA, 1997, Vol. 25, 301, 281.

to the particular are stronger than the universal.⁶³ Our inability to jump straight to large-scale unity, even at the level of Auroville as a whole, needs cultivated spaces that can engender camaraderie born of mutual interests ('an intimate mutuality') and aims at a more relatable level, a 'manageable unit of life'. Indeed, this trajectory is reflected in a long tradition civic-humanist and republican writing elsewhere, which can be explored for future research to inform organizational choices in Auroville.⁶⁴

This requires a conscious investment in developing and nurturing these associational forms through a confederated organization, proactively guiding new residents to their natural areas of association, with strategic and robust financial investment to support public events, programmes etc. that can attract common participation. This *cultural* infrastructure is an irreducibly public good, not just a convenient aggregation of convergent self-interest, that is necessary for the collective yoga. A nonpolitical, anti-partisan culture is an enabling condition for healthy governance:

No society can be called free in which these voluntary associations are not able to function, and the pulse of freedom will beat very slowly where they are not being spontaneously formed.⁶⁵

There are several fora in Auroville that operate along these lines (some of which we listed in Part I.B), but by all accounts, they require strengthening and expansion to develop a functioning civil society that can support, inform and check formal governance practices ground-up in established, settled ways of life that practice spiritual *living*. Whilst Auroville is to travel beyond conventions, stable social forms are required to generate community and for acculturation of new residents: collective opinion is socialized by the environment to a large degree, which requires for cultural leadership by the wise of each community to create an enabling environment for its development. While we cannot pursue this point in detail here, in Sri Aurobindo's schema, this would roughly amount to work on the 'circumconscient' or 'environmental' consciousness. A healthy environment can allow for conscious, supported acceptance, rejection and assimilation of ideals, feelings, modes of life brought in through external contact (with other zones and outside Auroville), nurturing individual development in a collective setting. This design principle looks to foster a conscious creation of sub-cultures, or group-souls, each with its own distinct temperament:

The ... society, like the individual, has a body, an organic life, a moral and aesthetic temperament, a developing mind and a soul behind all these signs and powers for the sake of which they exist. One may say even that, like the individual, it essentially is a soul rather than has one; it is a group-soul that, once having attained to a separate distinctness, must become more and more self-conscious and find itself more and

⁶³ A particularly interesting conversation with a resident on this issue led to the implications of the 'Dunbar' number on governance. Dunbar suggests a cognitive limit to the number of people with whom one can maintain stable social relationships at 150, popularly known as the 'limits of friendship'. If fraternity is key to political organization, then these findings support the creation of smaller, networked collectives as a means to effective participation and action. See, West et. al., 2020; David-Barrett et. al., 2012. This is an unsettled question, beyond our domain, but it offers an interesting area for research in Auroville to test this hypothesis. This is particularly given that Dunbar's framing seems to be in psycho-biological terms, which may be contrasted with Sri Aurobindo's spiritual thought that looks to progressively universalise associations through the *yoga*.

⁶⁴ See, for example, Taylor, 1985, Vol. 2, 195-8.

⁶⁵ Taylor, 1985, Vol. 2, 258.

more fully as it develops its corporate action and mentality and its organic self-expressive life.⁶⁶

Residents can thus find multiple ‘homes’ within Auroville, each operating by their own internal dynamic: ‘the health of democracy as a system of collective self-government’ depends on the strength of these associations that ‘can serve or disserve, raise or lower, facilitate or hamper the common debate and exchange which is an intrinsic part of conscious, informed collective decision.’⁶⁷ These smaller aggregates, or mini-publics, are an important design pillar for the democratic functioning of Auroville at scale, when *en masse* direct democratic meetings in the Residents’ Assembly become practically unviable. We consider this below in our suggestion for Zonal Assemblies.

Translating this into practical governance terms, collective spaces generate collective aspirations and alliances, binding residents together autonomously in matters of common concern and *action* – in doing so, as Taylor notes in his perceptive discussion on the need and necessity of civil societies, ‘by their mere existence or action [they] could have an effect on public policy.’⁶⁸ We have discussed the necessity and importance of the ‘public sphere’ in Part I.B, but given its relevance to governance reform, the term ‘public’ here requires some reflection. This is particularly important as several conversants noted a dimming of the *collective* vision in Auroville. Taylor’s clarification of what ‘public’ can mean is insightful:

The term [public] designates what is of common concern, and not just objectively or from an outsider’s perspective, but what is common recognized as of common concern. So public is what matters to the whole society, or belongs to this whole society, or pertains to the instruments, institutions, or loci by which the society comes together as a body and acts. So plainly the political structure of a society is public – its executive organs, the loci of its legislative power, and whatever spaces of assembly these require ...

The new notion of opinion in the eighteenth century defines a quite different model of public space. Through the circulation of newspapers, reviews, and books among the educated classes, and scattered, small-scale personal exchanges in salons, coffeehouses ... (from which) an opinion that deserves to be called ‘public’. Public opinion, as originally conceived, is not just the sum of our private individual opinions, even where we spontaneously agree. It is something that has been elaborated in debate and discussion, and is recognized by everyone as something held in common. This element of common recognition is what makes it public, in the strong sense.

This is also what gives it its force ... The novel aspect is that public opinion is elaborated entirely outside the channels and public spaces of the political structure. More radically, it is developed outside the channels and public spaces of any authority whatever

What was new was opinion, presented as that of society, which was elaborated through no official, established, hierarchical organs of definition ... public opinion

⁶⁶ Sri Aurobindo, CWSA, 1997, Vol. 25, 301, 35.

⁶⁷ Taylor, 1985, Vol. 2, 273.

⁶⁸ Taylor, 1985, Vol. 2, 204.

[is the way] in which society can come to some unity or coordination outside the political structures.

[Civil society comprises] a public, but not a politically structured domain. The first feature was essential: civil society was not the private sphere ... This defines a pattern of public social life, and not just a collection of private enclaves. This notion of civil society ... can inspire radical political hopes.⁶⁹

The formal institutional practices of decision-making in the Residents' Assembly and Working Groups represent one sense of public, the *political* track, whilst Taylor here emphasizes (as does Sri Aurobindo) the *cultural* or *extra-political* track. Both are necessary, but culture informs governance and ought to precede it: 'a flourishing public sphere is essential to [the formal institutions of] democracy.'⁷⁰ This was also Mother's twin approach in the early years, for example in the Ford Foundation letter, with clear and organized decision-making channels supported by a culture of robust interchange amongst those involved in each sector.

The common complaints of the over-bureaucratization of Residents' Assembly, the distance of the Working Groups from on-ground realities etc., seem to stem from a radical hope of self-governance absent regulatory control. To take up from our discussion on this point in Part I.B, this is an early expression of the ideal of a free and spontaneous brotherhood of the spiritual anarchist, that looks to limit the need and necessity of regulatory control and its bureaucratic forms. To achieve its end, it warrants a large net of well-organized public spaces and institutions that generate smaller, more organic and natural associations to drive *action* (not merely proliferate arguments) in city-building. This net can englobe the formal institutional practices: if the Residents' Assembly and Working Groups are the skeleton, the alliance of sub-zonal public spheres forms the joints necessary for its fluid functioning.

Particularly, as we discuss below, the disengagement from collective fora, particularly the Residents' Assembly and the *perceived* imperviousness of the governance systems to individual input is a concern in Auroville today that has driven an apathy. This was a constant refrain in our conversations with those have not been members of Working Groups. A relative distance from those groups appears to have eroded trust.⁷¹ As Taylor notes:

⁶⁹ Taylor, 1985, Vol. 2, 217-219. *See also*, for a detailed discussion on these tracks, Habermas' formulation: 'The first kind of deliberation was meant to be formal and decision-oriented, taking place within the walls of Parliament [here, the Residents' Assembly]. The other, taking place among the public, was decentralized, distributed, informal, and diffuse, with the assumed function of setting the agenda for Parliament. Habermas additionally posited a porous demarcation between the two tracks, so as to allow for feedback loops between the two spheres. In so doing, he plausibly extended the early version of deliberative democracy, making it applicable to the actual world of representative democracies' Landemore, 2017, 53.

⁷⁰ Taylor, 1985, Vol. 2, 278.

⁷¹ *See*, for example, Auroville Today, January, 2020 ('No doubt, individuals need to work on their own issues with power, but this may also indicate a larger issue, which is the perception of how power is exercised in Auroville. For, in spite of the fact that numerous Working Committees and Councils have asserted that they have no effective power to enforce decisions and that the Residents Assembly is the final authority for decision-making in the community, there's a persistent belief in some quarters that the major working groups are 'power' bodies which sometimes act independently of the knowledge or wishes of the other residents.') Auroville Today, November, 2020 ('Over the last few months, the functioning of the Funds and Assets Management Committee has come under fire. The members are accused of following a top-down approach, wanting to accumulate power, lacking efficiency, not delegating issues, refusing collaboration, showing no respect for others, providing insufficient basic communication, and being arbitrary in their decisions. Those who object to its functioning now propose that the constitution of the FAMC is changed.') Auroville Today, December, 2019, 63 ('Recently,

A democratic society ... may find that its capacity to render genuine democratic decisions is enfeebled either through a narrowing of participation or through a rift in the political community ... [this] is the familiar sense of citizen alienation at in ... centralized, bureaucratic societies. The average citizen feels power to be at a great distance, and frequently unresponsive. There is a sense of powerlessness in face of a governing machine that continues on its way without regard for the ordinary people, who seem to have little recourse in making their needs felt.⁷²

The appropriate remedy then is to have a network of smaller collectives, exercising power at the sub-zonal and zonal levels, nested in the whole:

The model which seems to work here is one in which smaller public spheres are nested within larger ones, so that what goes on in the smaller ones feed into the agenda of the [central] sphere.⁷³

This carries seemingly benign, but important, practical advantages. Smaller collectives are likely faced with local challenges suitable to be solved at that level, without spill-over concerns. They are closer to the experienced realities on-ground, with decisions having a direct bearing on participants in the discussion. They generate easier, more organic participation, without the burdens of large assemblies, with issues that place relatively reasonable cognitive and resource demands for informed decision-making. They are also more likely to generate consensus, with a relatively greater alliance of interests and trust born of individual contact, without holding up developments in other sub-zones. At the same time, they can – through illumined representatives – mediate individual input to the broader assembly that would otherwise feel excluded from everything but the period elections to the Working Groups (thereby breeding the common apathy in Auroville against attending large meetings). And importantly, they can generate a sense of belonging to and within a community small enough that residents can have living relationships with others (‘our decision’, a sense of ‘us deciding together’). As Taylor concludes, echoing Mother’s views:

... radical hopes [of a vibrant civil society] can ... take an antipolitical form. One could dream of the nonpolitical spheres of society becoming more and more autonomous, more and more self-sufficient. Taken to the extreme, this offers a vision of a society without politics, where the government of men gives way to the administration of things.⁷⁴

much energy has gone into finding ways to reinvigorate Auroville’s organization, and the Residents Assembly in particular. There is a widespread feeling that our present organisation is dysfunctional. This is reflected, among other things, in a lack of vision and excessive bureaucracy. There is also felt to be a widening gap between the residents and the major working groups, leading to accusations that the Residents Assembly is being sidelined regarding certain important decisions.’) Auroville Today, June-July 2013, 287 (‘Observing that the working groups have been profoundly eroded by endless attacks and accusations of power games, to the point that less and less people want to serve in these groups, it has asked the community to define what the AVC should stand for.’) Auroville Today, March, 2011, 1 (‘In fact, our major working groups are increasingly seen as remote bureaucratic entities, making decisions behind closed doors to further the interests or perspective of a certain clique. This image, which is not necessarily true, generates both frustration and apathy in the larger community.’)

⁷² Taylor, 1985, Vol. 2, 279.

⁷³ Taylor, 1985, Vol. 2, 279.

⁷⁴ Taylor, 1985, Vol. 2, 217-220.

This sentiment, often expressed in our interviews, reflects an old demand, for example in Tocqueville:

With Tocqueville ... the only bulwark against mild despotism [generated by an assembly that limits engagement and participation in practice, a point made by Sri Aurobindo, and suggested by some conversants in relation to the Residents' Assembly] is free associations. Voluntary associations for all purposes are valuable. But their significance is that they give us the taste and habit of self-rule, and so they are essential for political purposes. But if they are to be the real loci of self-rule, they have to be nongigantic and numerous, and exist at many levels of the polity. This itself should be decentralized, so that self-government can be practiced also at the local and not just the national level [here, not just at the central level, in the Residents' Assembly and Working Groups]. If it does out in the former, it is in danger at the latter. 'In democratic countries the science of association is the mother of science', according to Tocqueville.⁷⁵

If the common complaint is that the regulatory infrastructure of the Working Groups is 'still drawn to the vocation of mobilizing and reorganizing its subjects' lives', those of the residents, the necessary corrective is to develop well-functioning, confederated public spaces at the zonal and sub-zonal levels.⁷⁶ Rejecting the executive authority or mandate of the Working Groups is, in Taylor's formulation, a 'seductively limpid formula' that offers little value as they are required for cohesive action. As we noted in Part I.B, Sri Aurobindo is similarly skeptical – the regulatory influence of the Working Groups is necessary for efficient coordination, cohesive planning and implementation across sectors at any serious scale: it is 'difficult to see ... [how one can organize] on a large and complex scale necessitated by modern life' without them, even in an anarchist setup like Auroville. Rather, a well-functioning zonal and sub-zonal organization, backed by a robust public space with interwoven associations, can act as a necessary *complement*. This requires a tradition of engaged and informed participation and action, supported by ways of life that are proactively self-organizing (for example, in each sub-zonal and zonal group drafting and executing five-year Development Plans, as the Masterplan proposed). These are, some exceptions apart, generally lacking in Auroville today.

At this point in Auroville's growth, the dissipated and unsystematic nature of development works discussed in Part III require a sustained and strong centralizing corrective to break some Gordian knots that have hampered city-building. This ground-clearing, as it were, can be met *positively* with a network of self-organizing communities that allow for the 'radical hope' of the spiritual anarchist to be prefigured in a confederated model. These 'nongigantic and numerous' spaces may risk dissipation (with an unnecessary 'proliferation of groups and discussion forums', as the Governing Board noted), and indeed, need not be devoid of their own 'politics'. Yet networked together in a firm organizational structure with an ethic of local decision-making and timely execution / implementation, they offer promise. This can be one practical translation of the ideal arrangement Mother refers to when she notes that 'at bottom'

⁷⁵ Taylor, 1985, Vol. 2, 222-223. There are of course important differences in his views and those of Sri Aurobindo and Mother. Space limits a more engaged discussion, but this is a fertile area for future comparative research for inform governance practices with allied traditions of thought.

⁷⁶ Taylor, 1985, Vol. 2, 223.

it is the ‘art of building unity out of complexity ...’⁷⁷ The vitality of these associations and the robustness of their cross-linkages offers a route to achieve this end. At the least, it is an experiment worth conducting. Spontaneity across actors is the aim, but its emergence and development must be zealously curated and nurtured through a carefully networked organization where the possibilities of its emergence are greater.

c. Auroville’s Social Contract: Anarchy, Authority and Illumined Hierarchies

Tying up our discussion till now, the question, simply put, is: what is Auroville’s ideal social contract? For a collective to build (a city of the ambition and scale of Auroville, no less) efficiently and peacefully, some commonly shared and supported arrangements to organize work must be specified. Practical choices between appropriate levels of centralization, channels of decision-making and implementation must be made for the building of a city of the scale of Auroville. This is not simply a reductive affair of drawing up organograms, process maps or codes of conduct, but the practical side of the collective yoga, of how parts relate to the whole, how each resident relates to the collective. The core question that presents for resolution is one of authority – the basic principles of a fair, just and sensible distribution of authority within the collective over common matters must be worked out. In a sense, the issue is one of the collective aspiring as a vehicle for the descent of the Divine, for the spontaneous and harmonious ordering of the collective. None can replace the authority of the Mother, yet the collective can aspire to it. Given as the collective is still an unstable play of the *gunas*, with infra-rational and rational elements, the question is as to the most effective interim arrangement suited for the time and purpose. We have discussed Sri Aurobindo and Mother’s socio-political views in Part I, and now attempt to detail that conceptual architecture in the empirical context discussed in Part III.

To begin with, Mother’s definition of governance, or organization, as ‘discipline in action’ is instructive: discipline, in its proper sense, is education, learning, a self-restraining arrangement of the complex and unruly parts of our being (around the best mental lights at our disposal, aspiring to the greater control of the psychic being, or spirit) to allow for effective action. Governance of a collective, by extension then, is learning to place voluntary restraints on our collective and inevitable unruliness to allow for effective, coordinated and collaborative action around the best available mental or spiritual lights. This is reflected in Mother’s suggestion for the appropriate governance form for Auroville, when asked what the ‘interim’ arrangement should be till a spontaneous ordering emerges amongst the collective, a high ideal that requires a substantial advance on the part of each. Mother responded:

A hierarchic organisation grouped around the most enlightened centre and submitting to a collective discipline.⁷⁸

This principle of ‘illuminated hierarchies’, if we may call it that, requires translation into an institutional form. To direct the life-energies of a collective – to ‘govern’ – requires a form: ‘without shape and form, life has no effective movement’. This ‘shape and form’ comes through

⁷⁷ Guigan, 2018, Vol. 2, 216.

⁷⁸ Guigan, 2018, Vol. 1, 328.

institutional moulds that select, plan, decide and execute, which – if enabling – can allow for effective movement; if not, it can disrupt life.

Considerations of *form* are key, to allow for the *substance*, the life-energies of the collective, to grow and move. The enlightened may move spontaneously in disregard of forms; yet, others, even those aspiring to spontaneity as in Auroville, require them as helpful scaffolds to arrange what is otherwise a complex mass of undirected – often colliding, clashing – and sub-optimally organized energies. This form may be *imposed by force* externally in authoritarian or hierarchical setups of varying intensities, through soft and hard enforcement (‘infra-rational’ mode of organization), or *voluntarily accepted* internally in democratic ones (‘rational’ mode of organization) – the challenge, in many ways, is to allow for diversity of the latter to operate with the efficiency and order of the former. This requires the consensual and willing agreement of all to work in and abide by commonly designed organizational setups, not because one accepts all decisions, but because one places the collaborative and fraternal ethic – that Mother emphasized more than anything else in her comments on Auroville in the *Agenda* – as the higher priority. The logic of collective action requires some harmonizing influence to bring together conflicting and diverse individual interests and sentiments, whether borne of prudence – that it is in one’s own interest to abide by a common agreement, or fairness – that is it reasonable to reciprocate with one’s peers, or deeper moral, or even spiritual, reasons – that one owes something to the community, as duty or as an expression of the Self.

Placing Auroville governance aspirations – the political or organizational aspect of the collective yoga – in philosophical context, the question is how the democratic social contract can be realized for a liberal, equal and harmonious ordering of the collective. The social contract tradition in democratic political theory, which Sri Aurobindo labels a ‘major idea-force of the future of a master potency’, is ‘the reason of each and all seeking for a basis of agreement.’⁷⁹ Absent agreement, at least on the *essential* bases of collective action (the building of the core aspects of the city, urban infrastructure, economy, housing, zonal development plans and so on), of governance forms on ‘who gets to decide what and how’, or more formally put, the legitimation of authority, the ‘life [of Auroville] will have not effective movement.’ Support for this organizational structure – the ‘shape and form’ – in turn will necessarily mean entrusting powers to a selection of residents to conduct action in their domains. It cannot be otherwise in anything but a small polity, for scale and specialization demand a division of labour and centralization of powers for effective action. This movement comes with characteristic concerns, chief among them being a recreation of infra-rational, ‘conventional’ hierarchies due to an oligarchic capture of power by a minority or a tyranny of the majority.⁸⁰ There is, by many accounts, a general reluctance in the community towards centralization of authority, out of fear of excesses, perhaps accentuated as a continuing imprint of the anti-authority sentiment of the early years.

Yet, the question of authority requires attention to dent the contrary and standard objections to ‘anarchist’ collectives, those of disorder, instability, ‘toothless’ enforcement – each reflected in

⁷⁹ Sri Aurobindo, CWSA, 1997, Vol. 25, 196. For the social contract tradition, *see*, Freeman, 2012; Jones, 2000; Sommerville, 2011. This can be a rich area for comparative exploration in Auroville.

⁸⁰ Sri Aurobindo, CWSA, 1997, Vol. 25, 446.

the unsystematic progression of city-building works since 2001, with a raft of unimplemented planning proposals, uncoordinated movements between sectors, weak executive powers for the Working Groups and so on.⁸¹ This is ‘indispensable’ in Sri Aurobindo’s view for effective unification, and clearly anticipated in Mother’s suggestion for a ‘hierarchic organization.’ The question is not *whether* Auroville needs a firm, yet sensible, centralized authority, but *how* the system is to be operated. For this, a brief reflection on the contents of Auroville’s social contract – an agreement on how this authority is to be constituted – is useful.

The reason for the social contract – its motivating force – is the recognition of the essential equality of all, as independent, autonomous agents to be governed by their own will and force. The question that animates this exercise, as Rothschild beautifully puts it, is:

The difficulty, in very general terms, is of the depiction of complicated and self-conscious lives. Everyone knows, by introspection of imagination, that individuals have different, conflicting desires; that they have needs, and they also have opinions about needs; that they have political, economic, and spiritual sentiments; that they want commodities, and power, and they want to avoid being vexed. It is easy enough to describe (or to hint at) all this in one’s own life, or in the tragedy of Oedipus, or in the biography of Voltaire. The great difficulty, for the political theorists of the enlightened disposition, was how to describe a universe, or a society, in which everybody has opinions and theories and conflicting, changing desires. It was to make a ‘system’ out of the innumerable, swerving *moleculae* of individual reflections and sentiments.

... For if everyone has his or her own system of motion, then it is difficult to think of their union as a system or a society. If everyone has the same principle of motion, then the system is too simple; it does less than justice to the subtlety of individual lives. If everyone has a theory of society, or an opinion about the principles of motion of other individuals, then the system must be a theory of people with theories.⁸²

The contract between each – a ‘fair and deliberate exchange’ voluntarily entered into, after a determination of each one’s own ‘reflections and sentiments’ – is then a basis for common action of all, supported by all. A social system of motion to introduce some order into the chaotic entropy of the ‘innumerable, swerving *moleculae*.’ As Sri Aurobindo notes: for the ‘common ends of the society’, each can contribute his own individual judgment, paying due regard to ‘the opinions of his fellows and to form in consultation with them’ a common judgment – this is the ‘share he contributes to the building of the total common judgment by which society must be ruled, his little brick in appearance insignificant and yet indispensable to the imposing whole.’⁸³ The ideal – the underlying basis for Auroville’s social practice – reflects an old idealism, an ‘impossible optimism’, for individuals to exercise the potential, the hidden capacity, to know the true ends of one’s life amidst conflicting desires and ignorance, and to be able to effectively dialogue with one’s peers to reach a common end dictated by the light of collective reason rather than custom or convention:

⁸¹ See, for a brief overview of standard objections and replies, Zalta, 2021, Section 4.

⁸² Rothschild, 2001, 49-50.

⁸³ Sri Aurobindo, CWSA, 1997, Vol. 25, 196.

The ‘intellectual faculties’ in every individual ... can be exercised in ‘rational conversation’, in sentiments, in the ordinary duties of private life, and in judging ‘the great and extensive interests of his country’ ...

The ordinary reason of individuals is more often the object of esteem, both for Smith and for Hume. ‘The qualities most useful to ourselves are, first of all, superior reason and understanding,’ Smith says in the *Theory of Moral Sentiments*. In Hume’s description of civilized society, ‘profound ignorance is totally banished, and men enjoy the privilege of rational creatures, to think as well as to act.’ Even the propensity to barter and exchange, the foundation of commercial society, is for Smith a consequence of the faculties of reason and speech. The psychological inequality which is characteristic of the division of labor, in which the few have ‘an almost infinite variety of objects’ while the lives of the ‘great body of the people’ are ‘simple and uniform,’ is for Smith the ‘great public evil’ of civilized society. But it can be prevented by universal public instruction, and by the ‘study of science and philosophy.’ The great body of the people can have multiple objects, or ideas with which to amuse themselves. They can become more disposed to examine political projects; they can be ‘instructed and intelligent.’⁸⁴

In an important passage, Sri Aurobindo picks up on this dynamic with a touch of realism: the reason for the social contract, he notes, is not because the reasoning capacity of each is equal – a positive view of the matter – but to *avoid* the pre-determined rule of a dominant class, the defining feature of ‘conventional’ or ‘infra-rational’ societies:

This must be, not because the reason of one man is as good as the reason of any other, but because otherwise we get back inevitably to the rule of a predominant class which, however modified by being obliged to consider to some extent the opinion of the ruled, must exhibit always the irrational vice of reason subordinated to the purposes of power and not flexibly used for its own proper and ideal ends.⁸⁵

But the contract has limits: in the non-public sphere, the private domain, each is to be ‘left free to govern their own life according to their own reason and will and find freely its best possible natural adjustment with the lives of others.’⁸⁶ This ideal – the basis of democratic practice, with each contributing her judgment to aggregate to a collective will – is the ideal agreement, embodied formally in an assembly of freemen, the Residents’ Assembly:

In this way by the practice of the free use of reason men can grow into rational beings and learn to live by common agreement a liberal, a vigorous, a natural and yet rationalised existence.⁸⁷

⁸⁴ Rothchild, 2001, 150.

⁸⁵ Sri Aurobindo, CWSA, 1997, Vol. 25, 196. This passage requires a deeper reflection that we can enter here. The social control may be open, or disguised, i.e., ‘how to provide inducements which will make the individuals do the desirable things without anyone having to tell them what to do.’ Rothchild, 2001, 153.

⁸⁶ Sri Aurobindo, CWSA, 1997, Vol. 25, 196. A research exercise to construct an ‘ideal social contract’ for Auroville is an exciting research possibility, to allow for communal self-reflection on the fundamental bases of distribution and manner of exercise of authority.

⁸⁷ Sri Aurobindo, CWSA, 1997, Vol. 25, 197. There is a further point, of moving from an *aggregation* of individual interest to an *association* of common interest, which is key to the practice of the ideal in Auroville. We discuss this in Part IV.A.

So far, so good. Yet, ‘in practice it is found that these ideas will not hold for a long time.’⁸⁸ The trouble, as all troubles do, comes back to our imperfect natures. On one hand, the burden of knowledge seeking placed on man, inevitable in the evolutionary scheme of things, has a long gestation period, leaving many, if not most, in a state of perplexity – with convention no longer a guide to action, reason struggles to arrive at sure footing:

The ‘new conquering empire of light and reason’ is in Burke’s description a purgatory of universal reflectiveness; a ‘monstrous fiction’ of ‘inspiring false ideas and vain expectations’ in men destined to obscurity. It promises a tumult of multiple, competing theories, in which individuals are ‘hesitating in the moment of decision, sceptical, puzzled, and unresolved.’⁸⁹

In Sri Aurobindo’s schema, the unpurified, unruly vital takes its toll and demands its due:

For the ordinary man is not yet a rational being; emerging from a long infrarational past, he is not naturally able to form a reasonable judgment, but thinks either according to his own interests, impulses and prejudices or else according to the ideas of others more active in intelligence or swift in action who are able by some means to establish an influence over his mind. Secondly, he does not yet use his reason in order to come to an agreement with his fellows, but rather to enforce his own opinions by struggle and conflict with the opinions of others ... Finally, he does not use his freedom to arrive at a rational adjustment of his life with the life of others; his natural tendency is to enforce the aims of his life even at the expense of or, as it is euphemistically put, in competition with the life of others.⁹⁰

What this results in, as we discussed in Part I, is one of two things: the ‘precarious rule of a dominant class’, a ‘pseudo-democratic falsehood’ and second, a ‘perpetual strife of parties’, ‘an increasing stress of competition’, an ‘ordered conflict’ through the assertive mechanism of rights, each claiming a convenient distributive pattern with ‘an impotent and sterilizing chaos of names, labels ...’, yet at base, ‘a battle of conflicting interests’. *Rajas* dominates *sattva*. Or, as Smith puts it:

... he [the ‘man of system’] seems to imagine that he can arrange the different members of a great society with as much ease as the hand ranges the different pieces upon a chess-board. He does not consider that ... in the great chess-board of human society, every single piece has a principle of motion of its own.⁹¹

In some ways, this is apparent in Auroville’s collective workings, with common complaints of partiality, interest-based / group-centred lobbying, ‘committee packing’, opaque distributive patterns in housing, oligarchic capture of decision-making processes, participatory processes leading to blockages etc. The formal democratization of Auroville, whether in the Residents’ Assembly or Working Groups, is in many ways nominal – with limited engagement and a few drivers of action – for institutional reasons as much as for psychological ones: ‘for even when it is the majority that nominally governs, in fact it is always the reason and will of a

⁸⁸ Sri Aurobindo, CWSA, 1997, Vol. 25, 196.

⁸⁹ Rothschild, 2001, 151.

⁹⁰ Sri Aurobindo, CWSA, 1997, Vol. 25, 197.

⁹¹ See, Rothschild, 2001, 49-50.

comparatively few effective men and not really any common reason and will of all that rules.’⁹² In one sense, this is natural and expected in the course of Auroville’s socio-political evolution, particularly given the absence of a strong centralizing force (a ‘hierarchic organisation grouped around the most enlightened centre’) and a sufficiently diffused fraternal ethic (‘collective discipline’). One may only expect it to intensify as numbers and diversity grow. This ambiguous relationship to authority, a common refrain in conversations, is understandable – the element of power and strength is most troublesome and most corrupted, prone to excesses:

The perversions of Rudra power in the heart are stormy passion, wrath and fierceness and harshness, hardness ... egoistic ambition and love of ... domination.⁹³

But, ‘on the other hand’, if this ‘energy and power of assertion have been ... discouraged’, the resulting ‘incapacity of force’, of the collective force of governance in this context we may say, is also ‘an imperfection’:

Laxity and weakness, self-indulgence, a certain flabbiness and limpness or inert passivity of the psychical being are the last result of an emotional and psychic life in which energy and power of assertion have been quelled, discouraged ...⁹⁴

The governance challenge of the collective yoga is precisely to navigate this element of *power* – the currency with which the social contract is negotiated:

Nor is it a total perfection to have only the strength that endures or to cultivate only a heart of love, charity, tolerance, mildness, meekness and forbearance. The other side of perfection is a self-contained and calm and unegoistic Rudra-power armed with psychic force, the energy of the strong heart which is capable of supporting without shrinking an insistent, an outwardly austere or even, where need is, a violent action ...⁹⁵

In Sri Aurobindo’s thought, we find three practical responses – all supplemental to the inner work – to address these concerns: institutional design to channelize energies, education and awareness to purify the vital and widen the mental domains, for information participation and an inner evolution to engender greater solidarity. We reflect on each in turn.

First, Sri Aurobindo speaks of a federated organization of the collective, with an intelligent rationalization by a centralizing governing body. This governing body recognizes a separation of legislative and executive powers in standing bodies – the legislative power being embodied in an assembly and the executive power in a specialized, technocratic bureaucracy, interacting with an enlightened – vigorous yet ordered – democracy from below. This distribution of powers in the collective – an arrangement of the social contract – operates on a system of checks and balances to avoid an exclusive concentration of power, whilst allowing, if the cultural ethic permits it to, those of competence and capacity (the ‘most enlightened centre’) to occupy leadership. He notes:

⁹² Sri Aurobindo, CWSA, 1997, Vol. 25, 210.

⁹³ Sri Aurobindo, CWSA, Vols. 23-24, 736.

⁹⁴ Sri Aurobindo, CWSA, Vols. 23-24, 736.

⁹⁵ Sri Aurobindo, CWSA, Vols. 23-24, 736.

The government of a modern society is now growing an exceedingly complicated business in each part of which a special knowledge, special competence, special faculties are required and every new step towards State socialism must increase this tendency. The need of this sort of special training or faculty in the councillor and administrator combined with the democratic tendencies of the age might well lead to some modern form of the old Chinese principle of government, a democratic organisation of life below, above the rule of a sort of intellectual bureaucracy, an official aristocracy of special knowledge and capacity recruited from the general body without distinction of classes.⁹⁶

As we outlined in Part I.E., Mother's proposal for 'illuminated hierarchies', as also Sri Aurobindo's discussion, outlines a *qualified* democracy, aspiring to 'spiritual anarchism'. It is neither an unregulated 'anarchism' nor a model of unstructured participation. This is both for efficiency and moral reasons. In terms of efficiency, a point of some concern in Auroville's development, he notes:

This method accords ill with the more stringent ideas of efficient government and administration that are now growing in force and necessity and it might be fatal to efficiency in anything so complicated as the management of the affairs of the world.⁹⁷

And in terms of moral reasons, Sri Aurobindo echoes Mother's views, that the political equality of all does *not* imply that 'the reasoning capacity of each is equal', such as would support a majoritarian, aggregative democratic system; rather, the thrust is negative, to *avoid* the pre-determined rule of a dominant class. Indeed, it bears noting that this is as likely in a formally democratic system – the Residents' Assembly or Working Groups –, for *post hoc* rationalization can disguise itself as disinterested and impartial public reasoning:

... for in the present imperfection of the human race that always means in practice the fettering and misapplication of reason degraded into a servant of power to maintain the privileges of the ruling class.⁹⁸

Auroville's governance must then develop selection processes – as we propose in Sections B and C below – that match power to verified competence, a meritocratic hierarchy that determines decision-making with robust, yet structured and weighted, participation. Naturally, this ideal too carries risks, of the perceived rational and spiritual elite dictating views in the name of the community's own best interest, another form of technocratic or oligarchic capture that can limit individual freedom. Carter places this problem of an enlightened despotism – which Sri Aurobindo discusses in some detail in Chapter XXI of the *Ideal of Human Unity* – in sharp relief:

The higher self is the rational, reflecting self, the self that is capable of moral action and of taking responsibility for what she does [we may extend this to the spiritual self in Auroville's scheme]. This is the true self, for rational reflection and moral responsibility are the features of humans that mark them off from other animals. The lower self, on the other hand, is the self of the passions, of unreflecting desires and

⁹⁶ Sri Aurobindo, CWSA, 1997, Vol. 25, 472.

⁹⁷ Sri Aurobindo, CWSA, 1997, Vol. 25, 473.

⁹⁸ Sri Aurobindo, CWSA, 1997, Vol. 25, 195-6.

irrational impulses. One is free, then, when one's higher, rational self is in control and one is not a slave to one's passions or to one's merely empirical self.

The next step down the slippery slope consists in pointing out that some individuals are more rational than others, and can therefore know best what is in their and others' rational interests. This allows them to say that by forcing people less rational than themselves to do the rational thing and thus to realize their true selves, they are in fact liberating them from their merely empirical desires. Occasionally, Berlin says, the defender of positive freedom will take an additional step that consists in conceiving of the self as wider than the individual and as represented by an organic social whole — 'a tribe, a race, a church, a state, the great society of the living and the dead and the yet unborn'. The true interests of the individual are to be identified with the interests of this whole, and individuals can and should be coerced into fulfilling these interests, for they would not resist coercion if they were as rational and wise as their coercers. 'Once I take this view', Berlin says, 'I am in a position to ignore the actual wishes of men or societies, to bully, oppress, torture in the name, and on behalf, of their 'real' selves, in the secure knowledge that whatever is the true goal of man ... must be identical with his freedom.'⁹⁹

This risk is real and significant, yet not a sufficient reason to balk at the experiment of setting up illumined hierarchies. In his discussion on this point, Sri Aurobindo traces a related dynamic. He alludes to the necessary educative leadership of the 'advanced class or individual', but anticipates the dangers of them overstepping their proper role, by trying to permanently station themselves above or dictating set forms of truth ('a state or national religion' – in this context, an 'Auroville religion'), which yields an inevitable reaction from the collective to recover its autonomous action. Despite this, he notes that this is an 'experiment that could not fail to be made':

... the real business of the advanced class or individual is progressively to enlighten and train the whole body consciously to do for itself its own work and not eternally to do things for it. But the idea had to take its course and the will in the idea, — for every idea has in itself a mastering will for self-fulfilment, — had necessarily to attempt its own extreme. The difficulty was that the ruling man or class could take up the more mechanical part of the life of society, but all that represented its more intimate being eluded their grasp; they could not lay hands on its soul. Still, unless they could do so, they must remain unfulfilled in their trend and insecure in their possession, since at any time they might be replaced by more adequate powers that must inevitably rise up from the larger mind of humanity to oust them and occupy their throne.¹⁰⁰

State religions are an expression of this endeavour. But a State religion is an artificial monstrosity ... if it is not to formalise and kill in the end the religious spirit or prevent

⁹⁹ Carter, 2021, Section 2.

¹⁰⁰ In the perhaps distant ideal, Sri Aurobindo, CWSA, 1997, Vol. 25, 268 notes: 'There cannot fail to be a division into those who are able to live on the spiritual level and those who are only able to live in the light that descends from it into the mental level. And below these too there might still be a great mass influenced from above but not yet ready for the light. But even that would be a transformation and a beginning far beyond anything yet attained. This hierarchy would not mean as in our present vital living an egoistic domination of the undeveloped by the more developed, but a guidance of the younger by the elder brothers of the race and a constant working to lift them up to a greater spiritual level and wider horizons.'

spiritual expansion, [it] has to be tolerant, self-adaptive, flexible, a mirror of the deeper soul of the society ... [It] foredoomed to failure, failure by revolt of the oppressed social being or failure by its decay, weakness and death or life in death. Stagnation and weakness such as in the end overtook Greece, Rome, the Mussulman nations, China, India, or else a saving spiritual, social and political revolution are the only issues of absolutism. Still it was an inevitable stage of human development, an experiment that could not fail to be made ...¹⁰¹

True illumined leadership, like Mother's, will not fall afoul of these temptations: it will provide the necessary space and flexibility for individual growth and error, even when it seems contrary to its purpose, and proceed to illumine others, rather than prolong an enlightened oligarchy. Equally, the community's trust in the leadership, the principle of fraternity that Sri Aurobindo considers the *base* of any healthy polity, goes a long way in making this system workable, as does a thriving public culture that acts as a natural constraint on any excesses. Despite these risks, it is a 'fruitful' experiment to organize the collective not on the lines of a levelling-down equality (aggregative, preference-based majority voting), but hierarchies of inner capacity. Mother clarifies this point:

The true part is that every human being has the material right [to basic necessities]... (but it's not a 'right' ...). The organisation should be such, arranged in such a way, that everyone's material need should be met, not according to notions of right and equality, but on the basis of the most elementary necessities; then, once that is established, everyone must be free to organise his life, not according to his monetary means, but according to his inner capacities ... At bottom, the problem almost boils down to this: to replace the mental government of intelligence by the government of a spiritualised consciousness.¹⁰²

Second, these institutional forms rely on a diffused, informed and impartial collective rationality, able to overcome *rajasic* partiality in public matters, a major stumbling block yet in Auroville. Sri Aurobindo encapsulates the well-rehearsed dynamic between the disinterested reason and vital passions – discussed in the long Enlightenment tradition of Hume, Kant, Smith and others – in these observations:

Mankind, thus using its reason as an aid and justification for its interests and passions, thus obeying the drive of a partial, a mixed and imperfect rationality towards action, thus striving to govern the complex totalities of life by partial truths, has stumbled on from experiment to experiment, always believing that it is about to grasp the crown, always finding that it has fulfilled as yet little or nothing of what it has to accomplish. Compelled by nature to apply reason to life, yet possessing only a partial rationality limited in itself and confused by the siege of the lower members, it could do nothing else. For the limited imperfect human reason has no self-sufficient light of its own; it is obliged to proceed by observation, by experiment, by action, through errors and stumblings to a larger experience.¹⁰³

¹⁰¹ Sri Aurobindo, CWSA, 1997, Vol. 25, 460.

¹⁰² Guigan, 2018, Vol. 1, 225, 26.

¹⁰³ Sri Aurobindo, CWSA, 1997, Vol. 25, 108-9.

The natural remedy, then, is ‘education’, an inner disciplining of our vitally inspired partialities and excesses:

The natural remedy for the first defects of the individualistic theory in practice would seem to be education; for if man is not by nature, we may hope at least that he can be made by education and training something like a rational being. Universal education, therefore, is the inevitable second step of the democratic movement in its attempt to rationalise human society. But a rational education means necessarily three things, first, to teach men how to observe and know rightly the facts on which they have to form a judgment; secondly, to train them to think fruitfully and soundly; thirdly, to fit them to use their knowledge and their thought effectively for their own and the common good. Capacity of observation and knowledge, capacity of intelligence and judgment, capacity of action and high character are required for the citizenship of a rational order of society; a general deficiency in any of these difficult requisites is a sure source of failure. Unfortunately, even if we suppose that any training made available to the millions can ever be of this rare character, the actual education given in the most advanced countries has not had the least relation to these necessities.¹⁰⁴

It is with this in mind that our suggestions for a tertiary research infrastructure in Auroville, accompanied with a digital learning platform embedded in the city, can be considered. Indeed, as we discuss below, initiatives like the Citizens’ Assembly and Auroville Campus Initiative have an important role to play in this movement – not in randomizing decision-making, a popular trend in citizen’s assemblies inapt for Auroville in our view as it sits uneasily with the principle of ‘illuminated hierarchies’, but in securing more informed participation ‘from below’.

That said, there are some ‘inherent limitations’, a glass ceiling, even with a concerted attempt at progressively expanding collective rationality, a task with some distance yet to travel in Auroville. This is that the intellect, even the purified *buddhi* or ‘pure reason’, is unable to direct our vitality according to its dictates – something of the latter exceeds or eludes the well-intentioned and careful systematization of the former. The intellect, Sri Aurobindo notes, is

... unable to deal with life in its complexity or in its integral movements; it is compelled to break it up into parts, to make more or less artificial classifications, to build systems with limited data which are contradicted, upset or have to be continually modified by other data, to work out a selection of regulated potentialities which is broken down by the bursting of a new wave of yet unregulated potentialities.

The reason can govern, but only as a minister, imperfectly, or as a general arbiter and giver of suggestions which are not really supreme commands ...¹⁰⁵

Experience tells us that the translation of the ‘world of ideas proper to the intellect’ – the gymnastic ‘pure reason’, as for example, in the development priorities and governance mechanisms identified in this study as also others – to the ‘world of life’ is neither automatic nor easy. Our last tragedy, Hegel once remarked, is that the man of thought cannot also be a man of action – the turbid and powerful dynamism of the vital operates on a set of laws rather different from those of the mind, such that ‘the vital man ... degrades the apparent success into

¹⁰⁴ Sri Aurobindo, CWSA, 1997, Vol. 25, 198.

¹⁰⁵ Sri Aurobindo, CWSA, 1997, Vol. 25, 110.

a pitiful parody of their rational hope, their clear-sighted ideal or their strong counsel of perfection.¹⁰⁶

The idealism of various plans and proposals made since 2001, indeed those in this study as well, are proper to the reason yet unlikely to translate smoothly into the life of the community, which is moved by a complex mix of non-rational forces – ‘it would seem that these can only create either a series of more or less empirical compromises or else a series of arbitrary and practically inapplicable or only partially applicable systems.’¹⁰⁷

The concern with the limits to reason are two-fold. The first is the limited *power* of the intellect to transform the vital – it may restrain, remove the crude and violent excesses, yet not straighten the crooked tail fully. And the second is the limited *vision* of the intellect to harmonize contraries, other than at a remote ‘academic’ level unlikely to translate into action. One may, as we do briefly in this study, speak of an appropriate harmonization of centralization and decentralization, individualism and collectivism, liberty and equality – yet, either the *sattwa* of disinterested, intricate idealism is dominated by *rajas* in practice, or, as likely, it migrates as an ‘intellectual sannyasin’, to ‘an elevation where it ... separates itself from life.’¹⁰⁸ A submission to life or a flight from its messiness.

The ‘root of the difficulty’, then, is in discovering in *practice*, in *experience*, a supra-rational force and will that can both illumine the partialities of reason and generate sufficient power to transform the recalcitrant passions that refuse its dictates – the ‘intelligent rationalization’ of the collective, much needed in Auroville today, is proper and necessary, is still limited: it requires a progressive and ordered illumination of the collective mind through the slow and steady transference of control to the hidden psychic being in each by the practice of yoga. To the extent that is accomplished in the collective, through the rigors of inner discipline, the governance challenge, the collective yoga, may be addressed. The task is not to reject or delay a rationalization of the governance mechanisms – in preference for loosely cast customary practices that attempt to leapfrog this stage, the concern in Auroville today – but to progressively illumine, expand and render transparent forms of collective rationality embedded in these governance instrumentalities with smart and supple regulation.

And third, as the keystone of all movements, lies the development of bonds of inner fraternity. The swinging between the collective and individual tendencies, between liberty and equality, yields problems of participatory excess drawn from assertions of political equality or of disguised oligarchies, whether in legislative minorities or executive technocracies. Finding a resolution lies in deepening a federated, fraternal frame – this starts with the necessary but unstable patchwork of vital and intellectual associations born of alignment of interests, practical compromise and accommodations, a calculated give and take, or most nobly, a natural sympathy and friendship. Yet, it pushes for something deeper, more durable:

If we may judge from the modern movement, the progress of the reason as a social renovator and creator, if not interrupted in its course, would be destined to pass

¹⁰⁶ Sri Aurobindo, CWSA, 1997, Vol. 25, 555-6.

¹⁰⁷ Sri Aurobindo, CWSA, 1997, Vol. 25, 110.

¹⁰⁸ Sri Aurobindo, CWSA, 1997, Vol. 25, 111.

through three successive stages which are the very logic of its growth, the first individualistic and increasingly democratic with liberty for its principle, the second socialistic, in the end perhaps a governmental communism with equality and the State for its principle, the third if that ever gets beyond the stage of theory anarchistic in the higher sense of that much-abused word, either a loose voluntary cooperation or a free communalism with brotherhood or comradeship and not government for its principle. It is in the transition to its third and consummating stage, if or whenever that comes, that the power and sufficiency of the reason will be tested; it will then be seen whether the reason can really be the master of our nature, solve the problems of our interrelated and conflicting egoisms and bring about within itself a perfect principle of society or must give way to a higher guide.¹⁰⁹

The *rajaso-sattwic* action of the polity, the state in Auroville today, is bound inevitably in ‘conflicting (if at times disguised) egoisms’, even at its very small scale – if we take the economic sector as an example, the debate surrounding the 2017 Code of Conduct reflects the twin conflict. Absent a fraternal base, it will either result in a ‘competitive liberty of the strongest and most skilful to arrive’, or, as is the case today, a ‘strict regulation’ that mandates ‘equal association in the labour and the common profits of a collective life’. The collective, regulatory dimming of entrepreneurship thus has resulted, for fear of competitive liberties that may accompany the flow of capital. In this, the ‘idea and sentiment’, of a free and equal society, a Vedantic socialism, is oft-repeated in the records, yet these calls are ‘incomplete and combated by deep-seated nature and instinct and they are besides inconstant and fluctuate.’

This being so, the progression to fraternity will be conflictual, if vitally strong, or a dull patchwork, if vitally weak, the latter being the case in many key sectors. In either case, the true foundation – a vitally powerful, rationally illumined and spiritually sympathetic action of the collective – is to be built:

Thus the progress towards harmony accomplishes itself by a strife of forces and seems often to be no effort towards concord or mutual adjustment at all, but rather towards a mutual devouring. In effect, the swallowing up, not of one by the other, but of each by the other, so that both shall live entirely in the other and as the other, is our highest ideal of oneness. It is the last ideal of love at which strife tries ignorantly to arrive; for by strife one can only arrive at an adjustment of the two opposite demands, not at a stable harmony, a compromise between two conflicting egoisms and not the fusing of them into each other. Still, strife does lead to an increasing mutual comprehension which eventually makes the attempt at real oneness possible.¹¹⁰

Crucially, it is only with growing densities and bold action to take on yet uninitiated work in several sectors that this fabric will develop – Auroville needs to generate an energetic experiment, currently conducted at a rather glacial pace. In this, a peaceful and productive endeavour to build the city is unlikely, absent (i) centralized authority, in an enlightened assembly and professional competent, standing executive, (ii) an informed, impartial and vigorous rationality in public deliberation over matters of common concern and (iii) a progressive movement to secure a federated, fraternal base, through vital bonds of mutuality, sympathy and a network of voluntary associations. Auroville’s aspirations to ‘spiritual

¹⁰⁹ Sri Aurobindo, CWSA, 1997, Vol. 25, 193.

¹¹⁰ Sri Aurobindo, CWSA, 1997, Vol. 25, 290.

anarchism’ or ‘Divine anarchy’ must be understood in this complex, rich and ordered evolution, and not simply as a rhetorical tool to define a vague aspiration to the future. These are conditions precedent for a democratic setup to realize the ideal social contract in practice – the challenge being to match the nobility of the ideal with a strict inner discipline that can transform the recalcitrant elements of our nature. To attempt an unregulated, spontaneous ordering of the collective – ‘organicity’ – without disciplined foundations is a recipe for disaster: ‘they should not think of escaping from the outer control until the Divine control is there.’¹¹¹

Indeed, the inability of the collective to make significant progress on city-development since the 2001 Masterplan, despite repeated calls and proposals, presents sufficient reasons for a critical self-appraisal of governance mechanisms. Neither sentimentalism nor vague, if well-intentioned, calls for idealism will be sufficient. Decisive and clear pathways to action are necessary. The urban bullet must be bit. In this, the cultural disaffection with authority in the Auroville collective is understandable – yet, the construction of legitimate and effective authority, the governance question, is a *constitutive* part of the challenge of the collective yoga, of the aspect of Power. It is most susceptible to corruption, and thus resisted, yet integral for the realization. The collective may delay it, yet it cannot avoid it if an at-scale and vibrant city is to be built with the sense of urgency that animated Mother’s early stewardship.

v. *A Speculative Mapping of Governance to Mother’s Powers*

Given our discussion till now, we may also speculatively map Auroville’s governance framework to the involutory-evolutionary dynamic – discussed in Part I and in the visual representations above – of the four powers of the Mother, the Divine *shakti* or Consciousness-Force, the executive and manifesting power of the Divine in creation. These are represented in the inner petals of her symbol and have particular resonance in Auroville, as they are spatially organized in the four pillars of the Matrimandir and the four zones of the city. Sri Aurobindo’s *The Mother*, read with the *Life Divine* and other works, expounds the meaning and significance of these powers both in their Divine plenitude and in the veiled manifestation of our world in which they operate to drive the spiritual evolution, the twin aspects of Being and Becoming.¹¹² In Sections B and C below, we explain this arrangement in the context of (i) the Residents’ Assembly and proposed Zonal Assemblies, each with a bicameral Residents’ Council and Council of the Wise – Policy / Wisdom (ii) the Working Group and the proposed Unity Committee and Steering Group – Enforcement / Power, (iii) with reworked selection processes to reflect expertise – Execution / Perfection and (iv) a networked organization of the zonal and sub-zonal architecture for vigorous, cohesive local action – Community / Beauty. Needless to say, this mapping is naturally not analytically strict or precise, but speculative.

¹¹¹ Guigan, 2018, Vol. 2, 264.

¹¹² One may also relate this frame to the Vedic symbolism of the four orders, the Divine as knowledge in man, the Divine as power, the Divine as production, enjoyment and mutuality, the Divine as service, obedience and work. As Sri Aurobindo explains, ‘these divisions answer to four cosmic principles, the Wisdom that conceives the order and principle of things, the Power that sanctions, upholds and enforces it, the Harmony that creates the arrangement of its parts, the Work that carries out what the rest direct.’ Sri Aurobindo, CWSA, 1997, Vol. 25, 10.

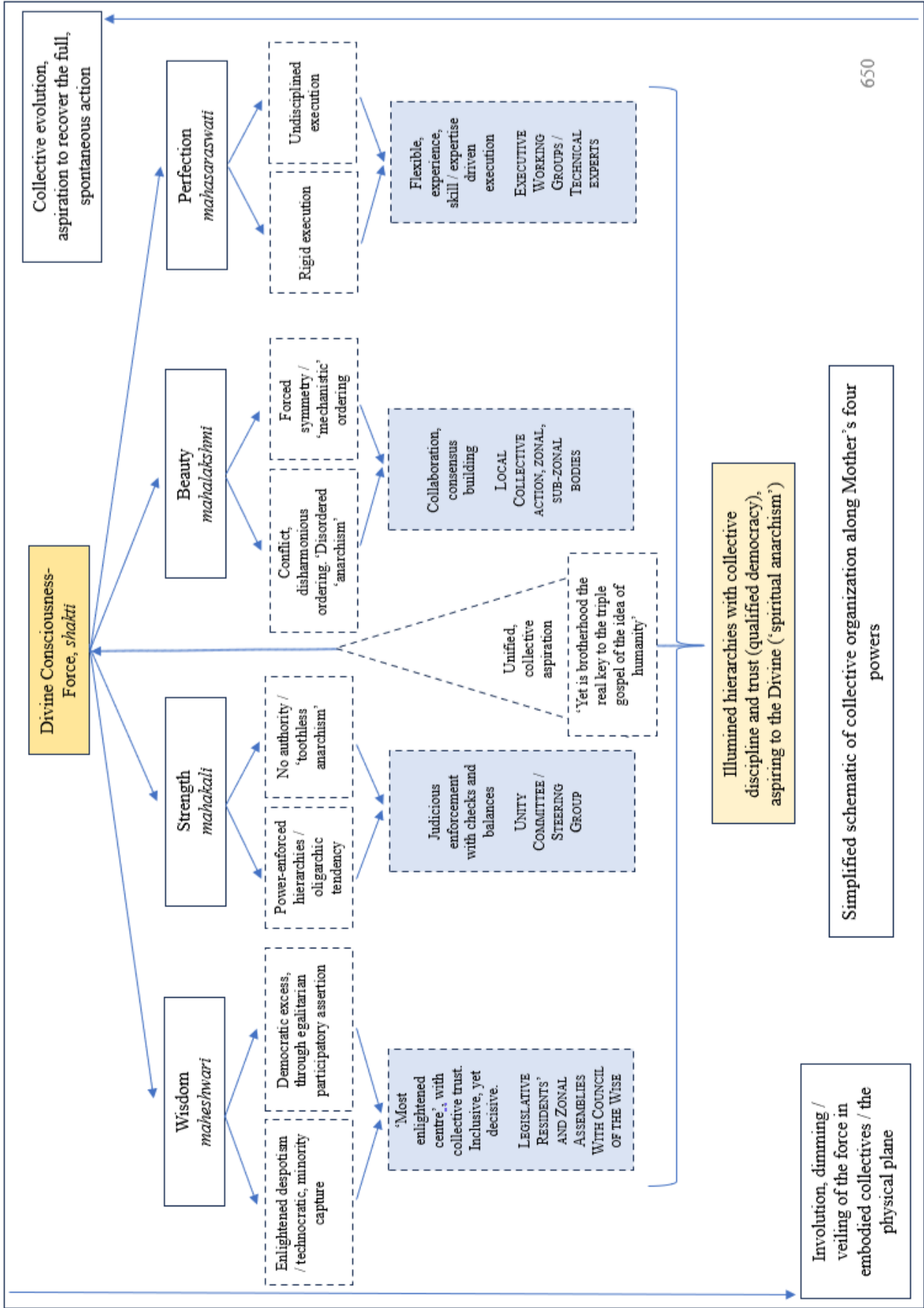

vi. *Institutional Limits*

Having discussed the need and necessity of governance reforms, the details of which we consider in Sections B, C and D below, it is important to note the limitations of any institutional restructure.

It was, finally, and it still continues a cherished error to imagine that the mere alteration, however considerable, of political or other machinery is the sufficient panacea for the shortcomings of civilisation. It is a change of spirit, therefore a spiritual change, that can alone be the sanction and the foundation of a greater and better human existence

The conditions in which men live on earth are the result of their state of consciousness. To seek to change these conditions without changing the consciousness is a vain chimera. Those who have been able to perceive what could and ought to be done to improve the situation in the various domains of human life — economic, political, social, financial, educational and sanitary — are individuals who have, to a greater or lesser extent, developed their consciousness in an exceptional way and put themselves in contact with higher planes of consciousness. But their ideas have remained more or less theoretical or, if an attempt has been made to realise them practically, it has always failed lamentably after a certain period of time; for no human organisation can change radically unless human consciousness itself changes. Prophets of a new humanity have followed one another; religions, spiritual or social, have been created; their beginnings have sometimes been promising, but as humanity has not been fundamentally transformed, the old errors arising from human nature itself have gradually reappeared and after some time we find ourselves almost back at the point we had started from with so much hope and enthusiasm.¹¹³

Institutions, in Sri Aurobindo's view, both *reflect* externally the current inner state of the collective and as importantly, *respond* to it with appropriate correctives to influence future development. While we must pay heed to Mother and Sri Aurobindo's repeated insistence that institutional machinery cannot achieve the ideal, yet it can play an important part in getting there. Perfection cannot be determined by machinery (it is 'vain dream' to think so), but progress can be facilitated by it.¹¹⁴ Form cannot replace substance, but it may hinder or help its emergence. Auroville needs to focus on governance and institutional reforms as we discuss in this part. These can go a long way in channelizing energies for city-building. Yet the tension between the legal form and the spiritual substance cannot be resolved *only* or *primarily* by institutional machinery:

In the end it always boils down to the same thing: a SUBSTANTIAL individual progress is required – a serious and sincere progress – then everything works perfectly.¹¹⁵

This institutionalist view, if we may call it that, regularly featured in our conversations – the idea that some particular institutional arrangement (a carefully constructed organogram or

¹¹³ Mother, CWM, 2002, Vol. 12, 40-1.

¹¹⁴ Sri Aurobindo, CWSA, 1997, Vol. 25, 14.

¹¹⁵ Guigan, 2018, Vol. 2, 331.

process-map for Auroville, as it were) can eliminate or reduce to a minimum the human element – that ‘the force of laws, and of particular forms of government’ is so great and has ‘so little dependence ... on the humours and tempers of men, that consequences almost as general and certain may sometimes be deduced from them, such as those we can deduce in the natural and mathematical sciences’.¹¹⁶ This is a noble dream, yet a dream nonetheless. The ‘pity of it is that this excellent theory’, the ‘objective’ view of life, is ‘sure to stumble over a discrepancy between its set ideas and the actual facts of human nature’.¹¹⁷ Governance mechanisms are, in the final analysis, a commentary on the collective state of consciousness – to make the institutional architecture proposed in this study, or otherwise, practicable, it must emerge from the daily rhythms of community life to be a living expression of organized action rather than a dead letter system.¹¹⁸ Sri Aurobindo, as also others, are categorical that institutional measures are often necessary but never sufficient:

They will especially not make the mistake of thinking that this change can be effected by machinery and outward institutions; they will know and never forget that it has to be lived out by each man inwardly or it can never be made a reality for the kind.¹¹⁹

The law is always the same, that wherever egoism is the root of action it must bear its own proper results and reactions and, however minimised and kept down they may be by an external machinery, their eventual outburst is sure and can be delayed but not prevented for ever.¹²⁰

Similarly, Hume asks:

... whether there be any essential difference between one form of government and another and, whether any form ... may not become good or bad, according as it is well or ill administered.

Were it once admitted that all governments are alike, and that the only difference consists in the character and conduct of the governors, most political disputes would at an end, and all zeal for one constitution above another, must be esteemed ... folly.¹²¹

Forms of government are important, but unless our mindsets change and our consciousness grow, Auroville’s ideal social contract, a free, equal and fraternal collective, will remain in a state of groundless hovering. In that spirit, the political *līlā* Auroville is to play requires both form, a supple yet firm organization, and substance, a demanding and disciplined inner evolution to guard the pull from below and deliver us to the attraction above:

Perhaps liberty and equality, liberty and authority, liberty and organised efficiency can never be quite satisfactorily reconciled so long as man individual and aggregate lives by egoism, so long as he cannot undergo a great spiritual and psychological

¹¹⁶ Hume, 1742, Chapter 11, Document 3.

¹¹⁷ Sri Aurobindo, 1997, XXV, 209. *See*, for a related discussion, Sen, 2009, 5-10 on ideal-institutional thinking and realization-based thinking.

¹¹⁸ *See*, for a useful discussion, Palmer et. al., 2015, 741-3.

¹¹⁹ Sri Aurobindo, CWSA, 1997, Vol. 25, 225-226.

¹²⁰ Sri Aurobindo, CWSA, 1997, Vol. 25, 394.

¹²¹ Quoted in Waldron, 2012, 1.

change and rise beyond mere communal association to that third ideal which some vague inner sense made the revolutionary thinkers of France add to their watchwords of liberty and equality, the greatest of all the three, though till now only an empty word on man's lips, the ideal of fraternity or, less sentimentally and more truly expressed, an inner oneness. That no mechanism social, political, religious has ever created or can create; it must take birth in the soul and rise from hidden and divine depths within.¹²²

One may design institutional forms supported by an intricate regulatory mechanism, a system of checks and balances, incentive structuring and so on to work around vital instincts – to envy, jealousy, greed, power, wealth, position, ambition, possessiveness, insecurity, partiality and others, all too well known. They may regulate, with more or less success, the outward kinetic movements of our nature, but cannot remain impervious to imperfections that lie beneath the surface. We may remember here Alexander Pope's wit: 'For forms of government let fools contest / Whate'er is best administer'd is best.'¹²³ As careful as the design may be, the root of the problem, and the promise for the future, lies within – the subtle determines the gross, such that any permanent and effective action must address the primary forces of our nature:

We have to distinguish the formed parts of our being, find out their basic defect of impurity or wrong action and correct that, sure that the rest will then come right naturally. We have not to doctor symptoms of impurity, or that only secondarily, as a minor help, but to strike at its roots after a deeper diagnosis.¹²⁴

What Mother and Sri Aurobindo emphasize time and again is the need for this progressive inner purification to reveal, slowly yet surely, the underlying unity and fraternity. This alone can secure a just, productive and happy polity – one that can welcome the free play of liberty and diversity, without envy, fear and control; one that can voluntarily restrain inequality to support one's community, without greed, possessiveness, competition and ambition; one that can voluntarily submit to legitimate authority, which in turn does not impose it with partiality or undue force; one that meets reasonable disagreements with goodwill and plasticity to find common solutions, rather than disguised plays to acquire power or rigid claims to universality; one that can welcome experiments and mistakes, dissent and criticism, in the right spirit. This, as Sri Aurobindo concludes, is the 'only sure foundation' – 'if this is not the solution, then there is no solution':

A deeper brotherhood, a yet unbound law of love is the only sure foundation possible for a perfect social evolution, no other can replace it. But this brotherhood and love will not proceed by the vital instincts or the reason where they can be met, baffled or deflected by opposite reasonings and other discordant instincts. Nor will it found itself in the natural heart of man where there are plenty of other passions to combat it. It is in the soul that it must find its roots; the love which is founded upon a deeper truth of our being, the brotherhood or, let us say, for this is another feeling than any vital or mental sense of brotherhood, a calmer more durable motive-force, the spiritual comradeship which is the expression of an inner realisation of oneness.¹²⁵

¹²² Sri Aurobindo, CWSA, 1997, Vol. 25, 383.

¹²³ Quoted in Waldron, 2012, 1.

¹²⁴ Sri Aurobindo, CWSA, 1997, Vols. 23-24, 645.

¹²⁵ Sri Aurobindo, CWSA, 1997, Vol. 25, 220.

Decidedly utopian, seemingly distant and to many credulous, this remains the ideal for Auroville to manifest as living proof of the collective yoga.

vii. *Questions to Consider*

In sum, for Auroville to build a city of the scale and ambition of Mother's ideal, a careful recalibration of governance mechanisms appears necessary. The organic development of a small-group, loosely networked governance model was perhaps suitable for the emerging needs and concerns of the small collective. If city development is to proceed with urgency and at-scale, a phase shift will be required to a model that preserves, yet channelizes, vigorous participation, with appropriate centralization, zonal federations and a clarification of legislative and executive domains. Given our discussion, the questions that arise for practical resolution in Auroville's governance today can be listed with relative ease:

1. How can the principle of 'illuminated leadership with collective discipline' be institutionally represented?
2. How is legitimate authority to be designed in terms of decision-making and enforcement mechanics, to harmonize efficiency, expertise and participation? How can expertise-driven and participation-driven decision-making processes be reconciled for Working Groups' selection, operation and accountability?
3. Does Auroville's current system exhibit 'a new form of modified oligarchy with a democratic basis', and if so, what institutional practices can generate a 'more democratic democracy'?
4. How can the three domains – of legislative action in the Residents' Assembly, of executive action in the Working Groups and local action in community – be organized in relation to each other?
5. How can institutional moulds at the central level, necessary and inevitable for a growing collective in the form of the Working Groups be reconciled with federated and local action?
6. What institutional design supports a local confederacy in Auroville? Does a federated bicameralism best meet this requirement?
7. How can representative democratic practices, necessary for effective decision-making at scale, even in an aspiring 'anarchist' setup, avoid the entrenchment of a 'political' class?
8. What bureaucratic and regulatory design is most suited to Auroville? How can the desired spontaneity of the 'spiritual anarchist' be cultivated in institutional practices, without falling into disorder born of vital subjectivism, the cramping of liberty born of excessive bureaucratic rationalisation or inertia born of a *tamasic* business-as-usual approach?
9. What practices and programmes of collective education can generate the needed enlightened participation 'from below'?

10. What is the unified ‘religion of humanity’ in Auroville’s context that generates the necessary inner architecture to support a progressive psychological oneness or fraternity? What is the appropriate organization of the public space that can support the collective *yoga*?

The answers are not as simple. Sri Aurobindo’s discussion on these points is not prescriptive of any defined institutional form that can be readily applied ‘as is’, but structures the field of possibilities in a more perspicacious way.¹²⁶ This is both the difficulty in reading Sri Aurobindo’s texts and the opportunity for experimentation with governance models in Auroville. In an interesting discussion entitled the ‘Internal Organization of Auroville’, Professor Joshi advanced this point around the time the Masterplan proposed an institutional structure in Appendix V:

In fact, I tell you the truth that by that time I had read *The Life Divine* twenty-five times, and yet when I started to find out Sri Aurobindo’s solutions in many books — I read many other books also equally — but if somebody said: ‘Tell me what is the solution,’ I had no answer as yet. Because Sri Aurobindo’s writings are so global and so vast that you have to make a real pointed study again and again to arrive at solutions.¹²⁷

Sri Aurobindo and Mother’s words thus leave important choices to be made – backed by past practices, empirical realities today, imagination and above all, an aspiration for the descent of their guiding Presence and Power – in terms of institutional design and sequencing of those designs depending on the state of evolution of Auroville at this time.

This lack of specification, we may note, is natural given that Sri Aurobindo locates his discussion in the variable and unstable play of the twin forces of unity and diversity (each tending to uniformity and dissipation at the physical, vital, mental and subjective levels) with institutional structures in a constant, dynamic feedback loop with the state of consciousness of the collective. Given this, there is no easy prescription of a *resting* institutional structure in his thought that can secure Auroville’s ideal. Rather, the need is for quick correctives to counteract both dissipation and uniformity through nimble institutional reforms in real time, moving to the ideal of a living diversity in oneness. This is, by all accounts, a lacuna in Auroville’s governance conversation, with a marked lag between repeated proposals for institutional reform and their adoption, resulting in an uncoordinated development that has missed opportunities for growth in the process.

Action and experimentation is key:

... inaction results in *tamas* which is a fall into Inconscience and the very opposite of progress and light.¹²⁸

... it is not always possible to accomplish the whole of the ideal by the first effort towards it. So long as we cherish the ideal whole and unbroken, we are at liberty to consult the demands of practicability and realise it, not at one rush, but by successive approximations, each being the vantage-ground for a fresh rush forward. This does not imply slow progress, the leisurely and gentlemanlike spreading out of the struggle for freedom through five or six centuries in order to avoid the perils of the struggle;

¹²⁶ Taylor, 1985, Vol. 2, 183.

¹²⁷ Joshi, n.d., 14.

¹²⁸ Guigan, 2018, Vol. 2, 248.

it is rather the necessary condition of rapid progress. The force of the hunger for the whole ideal, of impatience with half realisations must remain behind, but the means of each advance must be secured by that which went before.¹²⁹

For Auroville to innovate, its institutional processes must accommodate a rapid rate of experimentation – this requires strong doxastic-conative feedback loops from action to reflection, with reduced times between iterations. The question is not one of ‘applying’ Sri Aurobindo’s thought once and for all, but working with it to tease out suitable governance forms and reflectively and iteratively modifying them with the benefit of experience. Mother signalled this evolving approach:

It’s the experience of life itself that must slowly work out rules as supple and vast as possible, in order that they ever remain progressive. Nothing must be fixed. That’s the immense error of governments: they build a framework and say, ‘Here is what we’ve established, now we must live under it.’ So naturally, Life is crushed and prevented from progressing. It is Life itself, developing more and more in a progression towards Light, Knowledge, Power, that must little by little establish rules as general as possible, so as to be extremely supple and capable of changing according to need – of changing as rapidly as habits and needs do.¹³⁰

Taking this counsel, it is imprudent to attempt a longer, final resolution of these issues intellectually, *in abstracto*. Ideal governance systems cannot be instituted overnight, nor immediately legislated into existence absent a supporting cultural ethic of practice that takes time to develop. But the twin play of the forces of centralization and decentralization, the two antagonists, if well understood and managed through appropriate institutional forms, can over time develop a *living* organizational structure that responds to the spiritual aspirations for self-governance outlined by Mother.

Finally, as a pre-emptive remark, we note that our proposal for a confederated, representative and bicameral organization relies on institutional forms developed and practiced in part elsewhere. It is, in that sense, not new. This led some to argue that Auroville requires to find that new form. This is a reasonable view – the Full Report of the 2015 Retreat notes the ideas on both ends of the spectrum:

21	Auroville should keep experimenting with new structures / approaches.	We should rely upon old ways until we have the consciousness to use new ones	<i>Encourage widespread experimentation on alternative methods of governance in small groups. When something seems scalable, try it for a probation period in a larger work group with a fallback option to resume ‘normal service’ if it doesn’t work out.</i>
----	---	--	---

(Source: Full Report, Auroville Retreat, 2015, 67)

Two points can be made here. First, governance experiments are not made once and for all, with a single ‘solution’ found, that can be scaled up. Systems are tailored to circumstance, and

¹²⁹ Sri Aurobindo, CWSA, 1997, Vol. 2, 396.

¹³⁰ Guigan, 2018, Vol. 1, 226.

each in the network of sub-zones can develop, adapt, borrow accordingly as long as the action is effective. A system of networked zonal confederations will allow for experimentation, indeed at varying scales and in different sub-zones, each free to self-organize:

... none can tell how many attempts will have to be made and how many sediments of spiritual experience will have to be accumulated in the subconscious mentality of the communal human being before the soil is ready. For the chances of success are always less powerful in a difficult upward effort affecting the very roots of our nature than the numerous possibilities of failure.¹³¹

Second, Sri Aurobindo anticipated this debate. His thinking suggested suitable adaptations to previous setups, leaving open space for experiments. ‘Unforeseen possibilities’ in institutional setups may, one can hope, be worked up in the future in Auroville; but till then, he advises an incremental build on the past. Our proposals in this study are guided by this sentiment:

It may be questioned whether past analogies are a safe guide in a problem so new and whether something else might not be evolved more intimately and independently arising from it and suitable to its complexities. But mankind even in dealing with its new problems works upon past experience and therefore upon past motives and analogies. Even when it seizes on new ideas, it goes to the past for the form it gives to them. Behind the apparent changes of the most radical revolutions we see this unavoidable principle of continuity surviving in the heart of the new order. Moreover, these alternatives seem the only way in which the two forces [centralization and decentralization] in presence can work out their conflict, either by the disappearance of the one, the separative ... instinct, or by an accommodation between them. On the other hand, it is quite possible that human thought and action may take so new a turn as to bring in a number of unforeseen possibilities and lead to a quite different ending. And one might upon these lines set one’s imagination to work and produce perhaps a utopia of a better kind. Such constructive efforts of the human imagination have their value and often a very great value; but any such speculations would evidently have been out of place in the study I have attempted.¹³²

With this understanding, we conduct a brief exercise in translation, to provide a practical rendering of his and Mother’s views for Auroville today. Needless to say, these are suggestive templates, not detailed-out proposals. If considered viable, they will require further elaboration.

*

¹³¹ Sri Aurobindo, CWSA, 1997, Vol. 25, 247.

¹³² Sri Aurobindo, CWSA, 1997, Vol. 25, 575.

B. RESTRUCTURING THE RESIDENTS' ASSEMBLY

The Residents' Assembly is a statutory body constituted under Section 18 of the AVF Act, 1988. As we discuss in Part V, Section 19 of the Act consciously leaves open the mechanisms by which the Assembly is to operate, allowing future residents to organize and experiment. Historically, the Assembly has met as a single, undifferentiated collective comprising all residents – it is formally a 'direct' or 'pure' democratic body. This has naturally led to concerns with efficient and ordered decision-making, particularly as growing population numbers have made direct and meaningful participation difficult.¹³³ In this section, we briefly outline (i) the rationale and limits of democratic assemblies, to suggest a restructure of the Residents' Assembly along the lines of a (ii) representative, (iii) federated and (iv) bicameral setup, (iv) that distinguishes between legislative and executive functions, and (v) institutes procedural rules for ordered and informed deliberation and decision-making. Space limits to a more engaged discussion, yet this is a rich area for study in Auroville in conversation with democratic practice globally.

i. Rationale and Limits of Assemblies

Auroville's early years were characterized by informal, needs-based gatherings through weekly community 'general meetings'. The small numbers and scarcely populated landscape permitted and indeed, encouraged, this form of grassroots organization, with individuals volunteering for tasks in loosely defined groups as and when circumstances demanded. The autarchic ordering of the collective led, till the early 90s, to legislative action and authority by way of more or less fixed mass of unwritten, tacit customary habits emerging from the varied demands of the time.¹³⁴

¹³³ On 24th February, 2021, the Residents' Assembly Service announced 'their wish to pause all Residents' Assembly Decision-making (RAD) processes until a review is made of the existing decision-making policy and the RAS mandate.' The Auroville Council and Working Committee 'assured that this would be taken up with a deadline of 3 months', with a sub-group setup. *See*, News and Notes, No. 872, 2021. We were unable to locate the result of this study, or identify if any follow-up action was undertaken. Our reflections below are subject to the outcomes of this process.

¹³⁴ Murphy, 2009, 53-78.

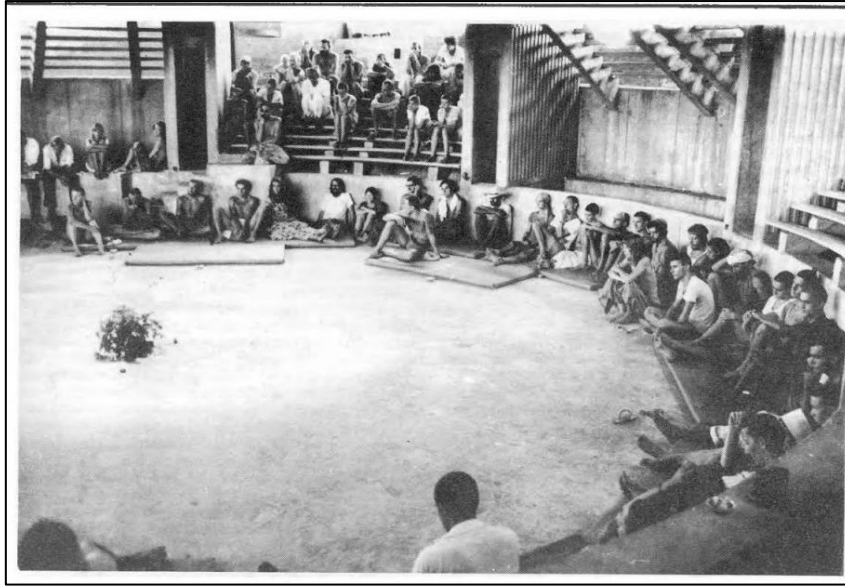

(Community meeting at Bharat Nivas, 1980. *Source*: Collaboration, 1980, 6)

The indexicality and local variation of custom seems to have served well the needs of the time, particularly in the absence of, indeed general aversion to, a codified, rules-based order. Sri Aurobindo's observations map on well to Auroville's early days:

In the early stage of society ... [this] complex customary law evolved indeed, but by a natural development of the body of social habits in obedience to changing ideas and more and more complex necessities. There was no single and fixed legislative authority to determine them by conscious shaping and selection or in anticipation of popular consent or by direct ideative action upon the general consensus of need and opinion.¹³⁵

Over time, this incipient organization responded to pressures to rationalize its workings – partially from within, with growing development works and partially from without, with the introduction of the AVF Act, 1988. This transition – from habitual norms emanating from practice to a centralized law-making authority – is natural, yet important:

... the government of society by its rational and practical mind which in contact with life's changing needs and permanent necessities demands a created and codified law determined by a fixed legislative authority, the society's organised brain or centre.¹³⁶

The AVF Act establishes a Residents' Assembly as an entity comprising all adult residents, without further definition of its working practices. This was a deliberate ambiguity, in Professor Joshi's drafting, to allow the assembly to experiment and develop conventions for decision-making to reflect a 'more democratic democracy'. In the early stages of the assembly, post 1988, the momentum of previous Working Groups continued, with limited interventions by the assembly as a whole. Moreover, small numbers meant that the boundary between discussions outside and inside the assembly were porous, with no defined legislative agenda or strict separation between executive and legislative functions. The regularity, mandate and format of discussions remained largely unspecified in the early years. With time, as the organizational

¹³⁵ Sri Aurobindo, CWSA, 1997, Vol. 25, 446.

¹³⁶ Sri Aurobindo, CWSA, 1997, Vol. 25, 447.

structure grew in response to a broader catalogue of activities, with a relatively greater complexity and the need for centralized coordination on policy matters, it appears that a quasi-legislative function was, and indeed still is, being conducted by the Working Groups in their domains, with oversight and ratification by the Assembly, with an unclear distinction between legislative and executive tasks. Participation in the Residents' Assembly, however, has historically been low, ranging on average between 4-8%, with a culture of small-group democracy practiced in other collectives – the Working Groups and other bodies – substituting for democratic participation. The Assembly, it appears, is perceived more as an umbrella body for special matters, particularly in crisis moments, than a legislature proper. Consistent with the general trend against centralization, the Residents' Assembly works not as the 'organized brain or centre', but as a community forum for matters of general concern brought up by petitions. It in this sense is functioning not as a standing body with a defined and regular legislative action, but more an irregular conference.

The earlier format of community 'general meetings', with a largely local, loosely coordinated action, reflected the rhythms of life in the early years, suited to the nature of the work at the time. It is useful to reflect today on governance mechanisms that may serve well the needs of the future – the imperative of ordered and cohesive action for city-building today, as indeed the spiritual and urban impulse to closer interchange and unification, requires a second look to clarify the purpose and placement of the Residents' Assembly in Auroville's governance. The question – within the scheme of administrative and legislative centralization outlined above, a natural progression in Sri Aurobindo's *Ideal of Human Unity* – is as follows:

... the great question must be settled, who is to be the State? Is the embodiment of the intellect, will and conscience of the society to be a king and his counsellors or a theocratic, autocratic or plutocratic governing class or a body which shall at least seem to stand sufficiently for the whole society, or is it to be a compromise between some or all of these possibilities? The whole course of constitutional history has turned upon this question and to all appearance wavered obscurely between various possibilities; but in reality, we can see that throughout there has been acting the pressure of a necessity which travelled indeed through the monarchical, aristocratic and other stages, but had to debouch in the end in a democratic form of government.¹³⁷

This is reflected in the qualified vesting of local 'sovereignty' in the residents' embodied in the form of the Residents' Assembly. The normative goal of democratic legislative assemblies is well-rehearsed in modern political theory – the social contract, 'the reason of each and all seeking for a basis of agreement', is reflected in democratic machineries, with the voice and vote of each resident accounting equally, at least formally.¹³⁸ Sri Aurobindo's reasoning on the nature and limits of the democratic practice, discussed above, as also of a vigorous literature elsewhere as relevant to Auroville, is complex and outside our scope here. Briefly, he provides both inherent and instrumental reasons in support of the collective right of the *demos* to regulate its own life, here of the Residents' Assembly to take the lead. First, *qua* their spiritual essence as equal beings evolving in their own way, the right to participate in governance *inheres* in each person:

¹³⁷ Sri Aurobindo, CWSA, 1997, Vol. 25, 454-5.

¹³⁸ Sri Aurobindo, CWSA, 1997, Vol. 25, 196. For the social contract tradition, *see*, Freeman, 2012; Jones, 2000; Sommerville, 2011. This can be a rich area for comparative exploration in Auroville.

It must be the reason of each and all seeking for a basis of agreement. Hence arises the principle of individualistic democracy, that the reason and will of every individual in the society must be allowed to count equally with the reason and will of every other in determining its government, in selecting the essential basis and in arranging the detailed ordering of the common life.¹³⁹

In this, Sri Aurobindo anticipates current models of participatory or deliberative decision-making. The basis of this social contract, as Gutmann and Thompson note, is that:

Persons should be treated not merely as objects of legislation, as passive subjects to be ruled, but as autonomous agents who take part in the governance of their own society, directly or through their representatives. In deliberative democracy an important way these agents take part is by presenting and responding to reasons, or by demanding that their representatives do so, with the aim of justifying the laws under which they must live together. The reasons are meant both to produce a justifiable decision and to express the value of mutual respect.¹⁴⁰

The legitimacy of the Residents' Assembly, both under the AVF Act, 1988 and in general principle, flows from the tacit consent and participation of all residents, with the 'state', the Assembly and its Working Groups drawing authority, at least formally, from the general will of the collective. Interestingly, as a matter of principle, this general will is not a reflection of the principle of popular sovereignty *simpliciter*, as democratic arrangements are, but rather, of the principle of spiritual individualism enshrined in the Charter which in turn gives moral force to the democratic principle in Sri Aurobindo's view:

It is sufficient for the first purposes of the rational age that each man should be supposed to have sufficient intelligence to understand views which are presented and explained to him, to consider the opinions of his fellows and to form in consultation with them his own judgment. His individual judgment so formed and by one device or another made effective is the share he contributes to the building of the total common judgment by which society must be ruled, his little brick in appearance insignificant and yet indispensable to the imposing whole.¹⁴¹

Professor Joshi, the drafter of the AVF Act, 1988 was explicit in linking the 'utter freedom' of the Residents' Assembly to the 'truth of individualism', the freedom to discover the deeper Self:

I think this Act (Auroville Foundation Act) has some very unique features, which you will not find in any act in the country ... The truth of individualism, as I said earlier in another context, is not merely the guarantee of individual freedom. This is something that is highest in many constitutions — that the moment you give the freedom of expression, freedom of association, you have given the best and the highest. That is not the concept of Auroville. Individualism is fundamentally service of the Divine in each individual. This is the real truth of individualism: to regard every individual who carries within himself the Divine and therefore the discovery of the Divine and manifestation of this Divine is the fundamental truth of individualism.

¹³⁹ Sri Aurobindo, CWSA, 1997, Vol. 25, 196.

¹⁴⁰ Gutman and Thompson, 2004, 3-4.

¹⁴¹ Sri Aurobindo, CWSA, 1997, Vol. 25, 196.

And since this discovery and manifestation cannot take place without the freedom, therefore underline the freedom.¹⁴²

Naturally, this ideal runs into serious practical difficulties: whilst the ideal of the freedom ‘granted’ under the AVF Act, 1988 is to allow residents the necessary space to experiment and organize forms of governance that may reflect the highest political aspirations of the collective, ‘the Divine anarchy’, the path to that elevated ideal is through the troubled and complex route of the ego. Unsurprisingly then, Sri Aurobindo’s discussion of *rajasic* excesses in democratic arrangements – outlined in Part I and discussed above in Auroville’s context – of an exclusively rights-based ordering of the collective (a ‘perilous experiment’, leading to an ‘ordered conflict’ of interests) resonates in the context of the Residents’ Assembly. This is a natural and expected imperfection:

Most governments either have now or have passed through a democratic form, but nowhere yet has there been a real democracy; it has been everywhere the propertied and professional classes and the bourgeoisie who governed in the name of the people.¹⁴³

Certainly, democracy as it is now practised is not the last or penultimate stage; for it is often merely democratic in appearance and even at the best amounts to the rule of the majority and works by the vicious method of party government, defects the increasing perception of which enters largely into the present-day dissatisfaction with parliamentary systems.¹⁴⁴

Similarly, in a much-cited meditation on the chronic imperfections of the democratic form, Rousseau declares that ‘were there a people of gods, their government would be democratic. So perfect a government is not for men.’ Answering this call, Sri Aurobindo points to a *demos* that can carry the democratic conception to its spiritualized ideal, Auroville’s ideal social contract. Auroville’s democracy, if we follow him, draws from a deepening of the democratic impulse, currently an expression of egoistic individuality to the discovery of the spiritual essence of each, ‘a people of gods’, one may hazard to say:

... an idea, a truth which, intellectually recognised and given its full exterior and superficial significance by Europe, agrees at its root with the profoundest and highest spiritual conceptions of Asia and has a large part to play in the moulding of the future.¹⁴⁵

This inherent, and hopeful, justification, that of spiritual individualism, the Divine essence in each individual, operating as the basis for political equality, is what Sri Aurobindo labels as a ‘idea-force of the future ... of a master potency’. In addition, Sri Aurobindo also provides an instrumental justification for the democratic form, also reflected in the practice of Auroville today, namely the idea that any matter of concern can be raised by mass petition before the Residents’ Assembly, which remains the final arbiter:

¹⁴² Joshi, 1999.

¹⁴³ Sri Aurobindo, CWSA, 1997, Vol. 25, 400.

¹⁴⁴ Sri Aurobindo, CWSA, 1997, Vol. 25, 456.

¹⁴⁵ Sri Aurobindo, CWSA, 1997, Vol. 25, 25.

[w]e cannot find a better means of checking ... authority than the knowledge that an appeal lies against one's decision to the whole assembly of the delegates, nor any stronger incentive to the growth of the public sentiment we desire to create than the knowledge that the final responsibility ... will rest on the whole body of the delegates.¹⁴⁶

This much is largely unexceptional, common fare in modern political thought – the nub of the issue, however, lies in the details of the machinery employed to embody the democratic principle, to overcome the ‘wide gulf between the ideal and the first results of its practice’, the ‘disparity between fact and idea that must lead to inevitable disillusionment and failure.’¹⁴⁷ The question is whether and how Auroville is work the democratic principle, through direct, representative, participatory, deliberative and other modes theorized in the literature, each of which finds mention in Sri Aurobindo's discussion. What is the appropriate form of a democratic arrangement in Auroville is the question one must consider here, suited to its current needs and future aspiration.

Two conflicting considerations emerge that require harmonization: the first is that the moral force of democratic individualism must be preserved to avoid an ‘oligarchic’, ‘pseudo-democracy’ and the second is to develop an institutional form that serves the imperative of collectivism, one that removes ‘internal competition, haphazard confusion and waste, enforcing and perfecting coordination, assuring the best functioning and a sufficient life for all.’ This is the tension reflected in discussions at the 2015 Retreat:

6	In Auroville everything must be decided by the Residents Assembly.	We need a centralized strong administration.	<i>The Residents Assembly organizes the work and activities of Auroville by setting up working groups which are empowered to implement their mandates, roles and responsibilities without Residents Assembly interference at implementation level.</i>
---	--	--	--

(Source: Full Report, Auroville Retreat, 2015, 65)

Commenting on this debate, Sri Aurobindo makes a striking comment: he notes that *if* ‘a democratic polity and machinery best assure [a] successful collectivist rationalisation of society’, a sufficiently cohesive, coordinated and efficient organization of the collective, one may consider it proper. Yet, if that is not the case, the democratic form remains susceptible:

... if a non-democratic polity and machinery are found to serve the purpose better, then there is nothing inherently sacrosanct for the collectivist mind in the democratic ideal; it can be thrown on the rubbish-heap where so many other exploded sanctities have gone.¹⁴⁸

¹⁴⁶ Sri Aurobindo, CWSA, 1997, Vol. 7, 999. These comments were made in the immediate context of the nationalist movement, but their application to other collectives is equally valid given the discussion in *The Human Cycle* on this point.

¹⁴⁷ Sri Aurobindo, CWSA, 1997, Vol. 25, 197.

¹⁴⁸ Sri Aurobindo, CWSA, 1997, Vol. 25, 204-5.

At the other end of the spectrum, he notes that the ‘central defect’ of a strong collectivist organization, operating in tension with the democratic principle, is its dimming of the space for individual expression and participation, other than by a formal vote:

Already the pressure of the State organisation on the life of the individual has reached a point at which it is ceasing to be tolerable. If it continues to be what it is now, a government of the life of the individual by the comparatively few and not, as it pretends, by a common will and reason, if, that is to say, it becomes patently undemocratic or remains pseudo-democratic, then it will be this falsity through which anarchistic thought will attack its existence. But the innermost difficulty would not disappear even if the socialistic State became really democratic, really the expression of the free reasoned will of the majority in agreement. Any true development of that kind would be difficult indeed and has the appearance of a chimera: for collectivism pretends to regulate life not only in its few fundamental principles and its main lines, as every organised society must tend to do, but in its details, it aims at a thoroughgoing scientific regulation, and an agreement of the free reasoned will of millions in all the lines and most of the details of life is a contradiction in terms. Whatever the perfection of the organised State, the suppression or oppression of individual freedom by the will of the majority or of a minority would still be there as a cardinal defect vitiating its very principle. And there would be something infinitely worse. For a thoroughgoing scientific regulation of life can only be brought about by a thoroughgoing mechanisation of life. This tendency to mechanisation is the inherent defect of the State idea and its practice.¹⁴⁹

The crux of the issue in Auroville is how to balance, or harmonize, these contraries. At a small scale, as in the early days of Auroville, a democratic principle is natural and relatively easy to secure – as numbers grow, but even at the current scale of 3000 residents, anonymity develops, primary bonds in the community are weakened and the distance between the centralized administration and the community inevitably widens, opening up the kind of debate one sees reflected in the 2015 Retreat document. Sri Aurobindo outlines this dynamic in speaking of small city-states, which bear the closest comparison with Auroville:

The tendency to a democratic freedom in which every man had a natural part in the civic life as well as in the cultural institutions of the State, an equal voice in the determination of law and policy and as much share in their execution as could be assured to him by his right as a citizen and his capacity as an individual, this democratic tendency was inborn in the spirit and inherent in the form of the city state. In Rome the tendency was equally present but could not develop so rapidly or fulfil itself so entirely as in Greece because of the necessities of a military and conquering State which needed either an absolute head, an emperor, or a small oligarchic body to direct its foreign policy and its military conduct; but even so, the democratic element was always present and the democratic tendency was so strong that it began to work and grow from almost prehistoric times even in the midst of Rome’s constant struggle for self-preservation and expansion and was only suspended by such supreme struggles as the great duel with Carthage for the empire of the Mediterranean. In India the early communities were free societies in which the king was only a military head or civic chief; we find the democratic element persisting in the days of Buddha and surviving in small States in the days of Chandragupta and Megasthenes even when great bureaucratically governed monarchies and empires

¹⁴⁹ Sri Aurobindo, CWSA, 1997, Vol. 25, 212-3.

were finally replacing the free earlier polity. It was only in proportion as the need for a large organisation of Indian life over the whole peninsula or at least the northern part of it made itself increasingly felt that the form of absolute monarchy grew upon the country and the learned and sacerdotal caste imposed its theocratic domination over the communal mind and its rigid Shastra as the binding chain of social unity and the binding link of a national culture. As in the political and civic, so in the social life. A certain democratic equality is almost inevitable in a small community; the opposite phenomenon of strong class distinctions and superiorities may establish itself during the military period of the clan. or tribe, but cannot long be maintained in the close intimacy of a settled city state except by artificial means such as were employed by Sparta and Venice.¹⁵⁰

The question then is how to develop a machinery that can respect the direct democratic action possible within a 'small free unit', located in a 'large concentrated unity' of several sub-units. In other words, the task for Auroville is to develop an institutional form and practice that allows for a 'more democratic democracy' to operate whilst satisfying the need for efficient and ordered collective action: the former risks splintering of the collective into autarchic, individual bubbles or a participatory excess, while the latter risks the substitution of a 'common agreement of all' into the operational will of a few, a 'semi-passive democracy'.¹⁵¹

Naturally, these concerns have been discussed in the collective over the years, with valid criticisms on both sides of the argument: on one hand, some have argued that the semi-autarchic ordering of the collective, with unstructured and inflated participatory forms, have 'muddled through' inefficiently, delaying action in the wait for universal consensus. On the other, many have argued that the Residents' Assembly and Working Groups are democratic in name, with limited meaningful participation and decisions driven, or blocked, by a few. It in this background that proposals for a 'Dynamic Residents' Assembly', 'Active Residents' Assembly', 'Citizen's Assembly' and others have been raised, attempting to balance the twin concerns of democratic engagement and effective, centralized action. In some ways, this is a natural and expected dynamic: the democratic freedom of all – finding expression in the 'anarchist' ideal of a small-group networks that have characterized Auroville's organization – for preserving individual space, and the collective imperative – finding expression, particularly in the last few years as a response to delays in city-building works, in the strengthening of the Residents' Assembly and Working Groups – for the kind of coordinated action needed for this enterprise.

One may hazard to say that the patterns of organization of the collective in the early years – with loosely organized small groups, developed piecemeal to respond to felt needs, working on the basis of fluid customary norms – are now beginning to face the challenge of scale and complexity. As Sri Aurobindo notes, 'a certain democratic equality is almost inevitable in a small community', yet it is 'only in proportion as the need for a large organisation' develops that the democratic principle faces pressure. Even at its current scale, but far more in anticipation of future population increases, will Auroville's governance aspirations be truly tested. The litmus test is this: can the city, in its tangibles and intangibles, be built truly as an expression of a unified collective aspiration? Alternatively, at either extreme, will the oligarchic tendency result in a semi-passive participation of all, *or* will the splintering of democratic

¹⁵⁰ Sri Aurobindo, CWSA, 1997, Vol. 25, 360-1.

¹⁵¹ Sri Aurobindo, CWSA, 1997, Vol. 25, 355, 471.

individualism result in each pulling in her own direction, disallowing a shared vision to manifest? Practically speaking, can Auroville keep alive the motivating democratic impulse, the rationale of the Residents' Assembly, yet innovate around the limits of such an enterprise?

We propose to this end a representative, federated and bicameral restructuring of the Residents' Assembly, with procedural rules for ordered, meaningful deliberation and a distinction between its legislative domain and the executive domain of the Working Groups. Space limits a detailed discussion: these are suggested templates that will require further elaboration and innovation, yet provide, in our view, one way to structure the institutional *machinery* that can render effective the democratic *principle* at scale. Needless to say, institutional machinery can help, but the conventions of practice and supporting cultural ethic will determine the success of the experiment. Much ink has been spilt on institutional reforms that can carry the democratic conception to its ideal – at the risk of caricature, one may say that institutional reforms are an important part of that exercise, yet the difficult and intractable issue of generating forms of life and cultures that nourish those institutions is key. The insecurity of institutions can only be shored up by social and political habits that sustain them.

ii. Direct Democracy At Scale

The Residents' Assembly currently functions, in principle, in a direct democratic setup, with each resident entitled to participate directly in the functioning of the assembly. Historically, participation in the assembly has been low, averaging between 4-8%, with numbers and engagement decreasing over time as numbers have grown. To the best of our understanding, in the past twenty years, no general meeting of the assembly has witnessed greater than 13% participation. The Citizen's Assembly pilot run in 2021 indicates low participation in the Residents' Assembly:

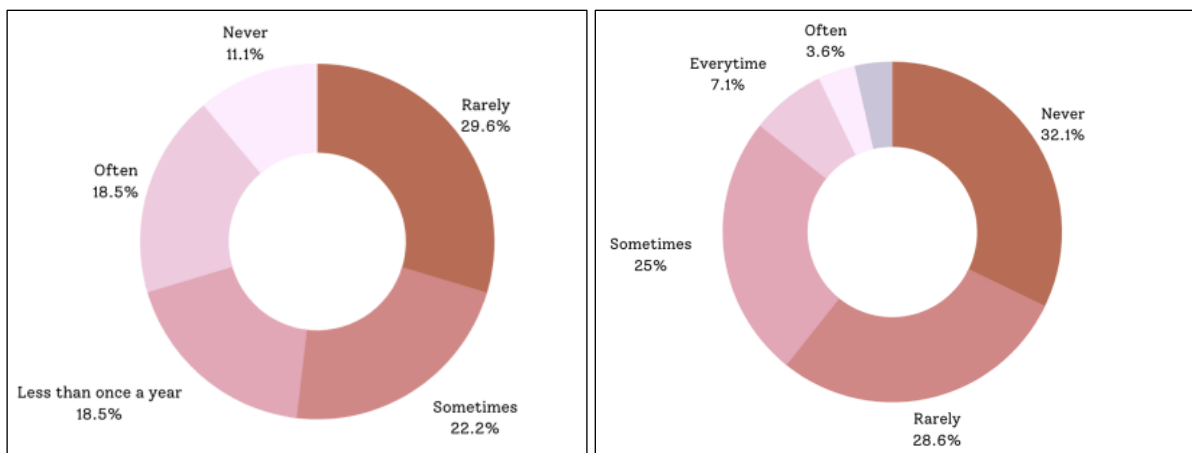

(Randomized survey responses. *Left*, 'how often do you attend community meetings?'. *Right*, 'how often do you vote in the RAD?' [Residents' Assembly Decision. *Source*: Citizens' Assembly Pilot Report, 2021, 12-3]¹⁵²

The ideal of a 'democratic democracy' articulated by Sri Aurobindo is naturally difficult, if at all possible, at scale, even with the small population of 3000 residents: this is so logistically,

¹⁵² These are responses from 41 residents who agreed to participate from a group selected at random, 23% of those approached. Our interviews seem to indicate that these responses are broadly representative. A comprehensive survey would be useful.

and more substantively, as a matter of principle, for a participatory dialogue at that scale is unlikely to allow for careful and engaged deliberation. As Taylor notes, outside the celebrated case of some Swiss cantons, ‘there isn’t and can’t be a meeting of the whole population in council.’¹⁵³ Indeed, aside from these concerns, there is a social consequence to operating such a democratic machinery: the inability for any individual resident to meaningfully influence the outcome, or even make a dent, in complex gatherings leads to frustration. It becomes, as many conversants expressed, ‘a waste of time’, with residents electing out with the exception of one-off attendance for particular matters one relates to strongly.

The logistical, emotional and mental demands of continuous and engaged participation in the Residents’ Assembly, an alluring ideal observed more in the breach, are by many accounts excessive.¹⁵⁴ This is again a common, unexceptional occurrence: ‘it is unimaginable that the people should remain continually assembled to devote their time to public affairs.’¹⁵⁵ For residents meaningfully engaged in their own affairs, across sectors, it is a demanding, and in the final analysis, untenable ask to devote time, effort and energy to prepare, attend, participate and follow-up on general meetings of the Residents’ Assembly, particularly as they relate to matters that may be remote from one’s daily life or immediate grasp.

This is a concern voiced across the board. The 2015 Retreat, as one example, recognized the ‘lack of participation’ as the ‘most critical challenge’ in Auroville’s governance, proposing a ‘dynamic Residents’ Assembly that reflects a more vibrant and functional organization’.¹⁵⁶ In a similar vein, Clarence-Smith recognizes the participation deficit, to argue that attendance in the Residents’ Assembly is not the appropriate measure for engagement. As one of few ethnographic works on governance in Auroville, we quote her at length:

In the largest General Meetings I attended during my fieldwork, there were approximately 200 people. Incidentally, this is the same number currently required for a community vote to be considered valid, and works out to approximately 10% of the adult Aurovilian population.

Many Aurovilians, and scholars of the community, use these figures as defining measures of ‘low’ political participation of Aurovilians. However, many community members who do not participate in General Meetings, or vote on community-wide matters, are engaged in forums at other scales, more directly related to their areas of interest and activity, and thus cannot be considered politically inactive. For instance, the monthly meetings of the Forest Group, which I sat in on during my fieldwork, were the best-attended of any sector group I knew - but I only ever saw very few Forest Group members in General Meetings.

¹⁵³ Taylor, 1985, Vol. 2, 274.

¹⁵⁴ See, for example, Auroville Today, February 2013, 2 (‘The Residents’ Assembly is a very unorganised and dysfunctional body’); Auroville Today, December, 2015, 60; Auroville Today, November, 2006, 2 (‘The functioning of the Residents’ Assembly (RA), created by the Auroville Foundation Act, is at the root of this problem. The Act makes it obvious that the RA is the authority to take decisions regarding the Auroville affairs. But it does not mention how the RA should function. Attempts to make this body an active entity have not been successful; its meetings are usually attended by less than 10% of Auroville’s adult population.’)

¹⁵⁵ Rousseau (trans. Cole), 1973, 217.

¹⁵⁶ Full Report, Auroville Retreat, 2015, 31. A similar proposal for an ‘Active Residents’ Assembly’ was made in 2001, with participation limited to a smaller group to streamline decision-making. This is close to a representative model we propose below.

In my observations and experience, virtually all aspects of community life and development in Auroville are constantly being deliberated and (re)defined, at various scales and in various - and sometimes overlapping - collective processes. These are notoriously time consuming and wearisome, even the staunchest proponents of such direct democratic practice concede that the engagement it requires is trying. The sheer magnitude of such processes occurring in Auroville at any given time is overwhelming; even dedicating myself full-time to doctoral field research, it was impossible to follow each, let alone be an active participant in them. When we consider this degree of routine political engagement that is embedded in everyday life in Auroville, and that this is at least part of the reason why people do not additionally participate in many community-wide processes, the attendance rates of the latter can no longer be considered as an accurate indicator of the political activity of Aurovilians.

That said, it is important not to ignore dissatisfaction with General Meetings and other collective, community-wide decision-making processes - much of which is common to direct and participatory democratic models and experiences worldwide as a significant deterrent to participation. Specific points of dissatisfaction include the high investment in time, lack of confidence in an actionable outcome, unpleasant interpersonal dynamics, and the challenge of public speaking. The latter is compounded in Auroville's multinational context given that meetings are held in English, which makes them not only difficult to contribute to, but even to comprehend for the community's many non-native speakers.¹⁵⁷

Disenchantment, distrust and disengagement with collective fora in Auroville is not a unique phenomenon – it reflects tendencies elsewhere.¹⁵⁸ It is also expected – Sri Aurobindo pointedly notes the inverse relationship between participation and scale, the problem Auroville is now seeking to solve:

Moreover, as we have already seen, the active and stimulating participation of all or most in the full vigour of the common life, which was the great advantage of the small but free earlier communities, is much more difficult in a larger aggregate and is at first impossible. In its place, there is the concentration of the force of life into a dominant centre or at most a governing and directing class or classes, while the great mass of the community is left in a relative torpor and enjoys only a minimum and indirect share of that vitality in so far as it is allowed to filter down from above and indirectly affect the grosser, poorer and narrower life below. This at least is the phenomenon we see in the historic period of human development which preceded and led up to the creation of the modern world. In the future also the need of a concentrating and formative rigidity may be felt for the firm formation and consolidation of the new political and social forms that are taking or will take its place
...¹⁵⁹

Indeed, it is interesting to note that these considerations are not new – in his *Politics*, Aristotle considers the limits of Greek Assemblies to account for the need for direct contact and engagement between citizens of the republic, a concern, albeit under different technological and social conditions, today in the Residents' Assembly:

¹⁵⁷ Clarence-Smith, 2019, 125-6.

¹⁵⁸ See, for example, Goot, 2002, 17.

¹⁵⁹ Sri Aurobindo, CWSA, 1997, Vol. 25, 358.

But what is this unsurpassable limit? It is easy enough to reckon on the basis of an examination of the facts. [In treating size, he gives emphasis to the public function of cities]: It is vital that the citizens know one another. In any event, for Plato and Aristotle, by far the most important criterion for determining the size of cities is political in character, and it is intimately linked with the problem of communication. The city must remain sufficiently small to permit the holding of public meetings with all of the citizens present.

Commenting on the time, Sri Aurobindo similarly alludes to the difficulty of recreating the Greek model, ‘an effective and personal share by each citizen in the actual government’ – the ideal of direct democracy being tested now in Auroville – in a ‘modern type’, by which he means at-scale polities. In an interesting remark, Sri Aurobindo identifies two immediate responses, each reflected in our conversations in Auroville: an ‘impotent anarchism’, which manifests in Auroville as a well-intentioned but formless reaction to ‘committee-talk’, and a retreat into one’s own private domain of work, ‘checking out’ of the collective. It is indeed telling that this is a concern even at the micro-level that Auroville is currently operating at with 3000 residents, far from the large state entities that Sri Aurobindo addresses:

The Greeks associated democracy with two main ideas, first, an effective and personal share by each citizen in the actual government, legislation, administration of the community, secondly, a great freedom of individual temperament and action. But neither of these characteristics can flourish in the modern type of democracy, although in the United States of America there was at one time a tendency to a certain extent in this direction. In large States, the personal share of each citizen in the government cannot be effective; he can only have an equal share — illusory for the individual although effective in the mass — in the periodical choice of his legislators and administrators. Even if these have not practically to be elected from a class which is not the whole or even the majority of the community, at present almost everywhere the middle class, still these legislators and administrators do not really represent their electors. The Power they represent is another, a formless and bodiless entity, which has taken the place of monarch and aristocracy, that impersonal group-being which assumes some sort of outward form and body and conscious action in the huge mechanism of the modern State. Against this power the individual is much more helpless than he was against old oppressions. When he feels its pressure grinding him into its uniform moulds, he has no resource except either an impotent anarchism or else a retreat, still to some extent possible, into the freedom of his soul or the freedom of his intellectual being.¹⁶⁰

If indeed the practice on the ground is the route through more manageable, smaller collective fora, as is expected in anything other than a small-scale community, a restructuring of the Residents’ Assembly to both reflect and facilitate this altered dynamic is a reasonable course of action. As numbers grow, a direct, *en masse* assembly, will be eminently unworkable: ‘in large States, the personal share of each citizen in the government cannot be effective.’¹⁶¹ Continuing with a formally ‘direct’ democratic setup in the Residents’ Assembly is either to continue a fiction or hope, absent reason, for engaged participation at scale in a single council. In the meantime, it would not be improbable for a minority to participate and drive action, in

¹⁶⁰ Sri Aurobindo, CWSA, 1997, Vol. 25, 509.

¹⁶¹ Sri Aurobindo, CWSA, 1997, Vol. 25, 509.

the name of the collective provided the low quorum of 10% is met. Indeed, this is already the case, with most residents, in our limited conversations, under-informed about the deliberations or decisions of the Residents' Assembly, and distrustful of disguised interest-dynamics that, at least in their perception, dictate collective decision-making.

If we are right in these observations, the allure of direct democracy, workable in the early years of the community in all-inclusive general meetings, requires recalibration to account both for increased numbers and the complexity of the problems that demand legislative action, which on any account will require a certain focussed action, specialization and dedication of time. None can be reasonably expected all of residents. The AVF Act, 1988 provides a statutory umbrella for the assembly, yet its drafter, Professor Joshi expected further experiments in governance to internally restructure the working of the assembly in time:

... this totality of residents has not been given any particular form of governance. Sometime some people reading from outside may feel it is a lacuna in the Act, that no form is given for the Resident Assembly. But from another point of view, it is a safeguard against imposition of any form. So you might say that there is an utter freedom given to the Residents' Assembly to experiment, to make research and to devise forms by which the divine anarchy can be realised. If the residents of Auroville know how to do it, if they ripen themselves into that consciousness, this freedom is ensured in the Act.¹⁶²

The time for that task, in our view, is now ripe. Complete solutions may not be at hand, but the challenges faced in the current setup give good reasons to attempt a representative, federated and bicameral model for the Residents' Assembly.

iii. Participation, Representation and Federation

To problem to solve in designing an assembly for Auroville is simply stated: what institutional form allows for meaningful and effective participation by residents in matters of concern, such that engagement is easy, non-time consuming and informed?

Each of these conditions is the subject of deep debate in the literature, as also anecdotally in conversations in Auroville.¹⁶³ While a detailed discussion is beyond our scope, we offer some reflections to justify our proposal for a representative Residents' Assembly with federated Zonal and sub-Zonal Assemblies. Two points may be considered here: first, qualifications on the value of assemblies in the trade-off between quality (informed and enlightened) participation and inclusion of numbers and second, the value and dangers of representation and the utility of smaller, federated assemblies.

a. Qualified Democracy and Inclusion

The value of assemblies is tied to the democratic principle discussed above – each residents having an equal share in the governance of Auroville as a reflection of the equality of all. Yet, it is important to note that the long-standing concern registered across thinkers that democratic assemblies *do not* have any necessary correlation to the quality of decision making. Numbers

¹⁶² Joshi, 1999.

¹⁶³ See, Fischer, 457-471, Ansell, 498-511, in Levi-Faur (ed.), 2012.

do not guarantee truth, and indeed, in many cases, are an active hindrance. As Sri Aurobindo emphasized, participatory equality guaranteed by the democratic form, where each resident has an equal say and share, does not imply that the reasoning capacity of each is equal. The primary concern is to avoid the pre-determined rule of a dominant class: respecting the essential personhood of each does not necessarily mean that the functional value of each individuals' opinion is equal. Indeed, Sri Aurobindo records, as do others, that the 'first results' of the 'momentous change' of democratization is 'disconcerting to the thinker and to the lover of a high and fine culture; for if it has to some extent democratised culture or the semblance of culture, it does not seem at first sight to have elevated or strengthened it by this large accession of the half-redeemed from below.'¹⁶⁴ Absent a general, diffused and sufficiently strong elevation of consciousness, the result will be 'to cheapen thought.' Democratic, participatory assemblies, then, are not an unmitigated good – a long tradition of democratic sceptics have registered cautions on this front. Indeed, Mother too was skeptical, calling it 'the reign of the most equally shared stupidity':

Because men still imagine that in order to do anything useful, they must gather together in groups. It is the caricature of organisation ... Twelve good men would be better than hundreds of stupid persons.¹⁶⁵

It is in this skeptical background – a recognition of the levelling-down common to democratic assemblies, and a wish for enlightened decision-making – that Mother's proposal for illumined hierarchies can be considered. The essential equality of all, indispensable in any modern system, does not translate to the functional equality of all – rather, assemblies may be organized to allow for a differentiation based on competence and capacity. There are naturally risks to this ideal, but one way in which this may translate into a workable institutional form is to: (i) create zonal and sub-zonal assemblies, where residents are likely to be better informed and in direct contact with local concerns; (ii) institute a representative Residents' Assembly, where each zone / sub-zone may select a representative ('the enlightened centre') for deliberation on city-wide matters, (iii) support awareness and informational networks and programmes (Citizen's Assembly, Campus Initiative, city-wide digital learning system proposed in Part III.E etc.) for informed decision-making, (iv) procedural forms in all assemblies for expert study and reports on matters to be debated.

For Auroville to instantiate or approach a true democratic enterprise, informed, meaningful and effective participation is key. This, as Taylor notes, 'is a source of great puzzlement in modern democratic society':

What exactly are we assessing when we consider ourselves with the quality of our collective decisions? It's easy to express the democratic aspirations: (1) the mass of the people should have some say in what they are doing to be, and just told what they are; that (2) this say should be genuinely theirs, and not manipulated ... and that (3) it should to some extent reflect their considered opinions and aspirations, as against ill-informed and knee-jerk prejudices ... Once spelled out like this, truly democratic decision-making has seemed utopian to many observers. It has been argued that the

¹⁶⁴ Sri Aurobindo, CWSA, 1997, Vol. 25, 90.

¹⁶⁵ Guigan, 2018, Vol. 1, 277; Guigan, 2018, Vol. 2, 264.

third condition is virtually never met ... that the average voter is too poorly informed, and too marginally interested, to cast an enlightened ballot.¹⁶⁶

Participation is indeed valuable, but only in proportion to how informed and enlightened it is – as such, it is not a game of numbers, but of quality. That said, participation *qua* participation is valuable for pedagogic and solidarity-generating reasons: the inclusion of all members of the community, even if they are not well-informed or best-placed to contribute to deliberation on a particular issue, is a mark of respect and trust that generates community and allows, in time, if supported by an awareness or educational support system, the development of faculties for intelligent participation. Indeed, the great value in projects like the Citizen's Assembly Pilot or the Auroville Campus Initiative lies here: in providing information and skill-training, one allows residents – who may otherwise not be informed of the finer details of matters of public concern or prefer to disengage from collective fora like the Residents' Assembly – to participate meaningfully in the democratic enterprise. The collective intelligence so generated can contribute to the quality of decision-making and generate a sense of community that makes it more likely to decisions finally made to be accepted and acted upon. Disengagement breeds distrust of collective fora: a *perception* of self-serving decision-making by those in positions of authority, even if not reflected in reality, is sufficient to derail the fragile democratic enterprise, denting the bonds of fraternity that alone can secure action for city-building in the face of inevitable diversity of opinion and disagreement. As Fischer perceptively notes:

Democratic participation is generally considered a political virtue unto itself. But participatory governance claims to offer even more; it is seen to contribute to the development of communicative skills, citizen empowerment, and community capacity-building ... The issue is critical for *participatory* governance as it has little or no meaning if citizens are neither capable nor empowered to participate.

...

Participation, it also needs to be noted, is more than a matter of competence. Competent people may not perceive an incentive to participate. Thus, getting them to do so is another important issue. Engagement in the public realm is not without its costs, and most people have little interest in participating unless the costs of engagement are outweighed by the possibility of the benefits from it. Local people, including competent citizens, may themselves be highly skeptical about the worth of investment their time and energy in participatory activities ... Finally, capacity-building, as the development of a community's ability to deal collectively with problems that it confronts, can contribute to a sense of social togetherness. Rather than the relatively passive role of the individual association with traditional conceptions of citizens participation, participatory governance helps to connect and enable competent individuals in local communities build together the kinds of 'social capital' need for joint problem-solving.¹⁶⁷

¹⁶⁶ Taylor, 1985, Vol. 2, 273-4. The reference to the 'ballot' may here be replaced by that of engaged participation in collective projects.

¹⁶⁷ Fischer, 459-60 in Levi-Faur (ed.), 2012.

The thrust of participatory and deliberative models of democracy, witnessing a spasmodic revival today, lies here.¹⁶⁸ The range of proposals witnessed in the literature, some tested in Auroville – citizen’s assemblies and panels, digital crowd-sourcing, devolution and decentralization of legislative powers among others –,¹⁶⁹ their practical difficulties aside, all aim at rescuing participation from the disengaged handing over of the business of government to the few.¹⁷⁰ This consensual self-hypnosis, as Sri Aurobindo caustically notes, is the ‘disease and falsehood of modern political life.’¹⁷¹ In response, he stresses the importance of an enlightened participation from below:

To democratise ... [is] in fact impossible without a popular awakening and widening of the political consciousness. Democracy is impossible without a demos, a people politically awake and active ... Oligarchy or democracy, authority or freedom are the issue, and no settlement can work which does not decide the question whether [we are] to remain a mute assembly swayed by a handful of men or a democratic body of as modern a development as the political conditions of the country will allow.¹⁷²

The key question here is: how is ‘popular awakening and widening’ of the residents’ ‘political consciousness’ to be activated? Is it through an insistence on greater volume of direct participation in assembly-like structures, or other modes? In particular, how are the standard problem with participatory processes – of burdens imposed on residents to engage in public affairs, inefficiency concerns, delays and participatory inflation and the need for expertise in public affairs unlikely to be found in popular bodies – to be addressed?

On the ease and effectiveness of participation, it is precisely this question of scale – of residents being distant from the *en masse* collective fora of the Residents’ Assembly – that yields a disengagement due to the burdens of participation. The logistics of taking time out, arranging personal affairs and adequately studying the matter to effectively participate, with the hope that one’s voice may carry in the multi-lingual collective that meets irregularly, is a tall order, if not a wishful one. A survey of the selection of residents who participated in the Citizens’ Assembly Pilot supports this assessment:

¹⁶⁸ We use these terms loosely. There is a flourishing literature on this subject. For a detailed discussion on the value of deliberative and participatory democratic forms, as opposed to ‘aggregative’ and ‘representative’ forms, *see*, Landemore, 2021; Landemore, 2012. For reviews of the practice of such collaborative forms, *see*, essays in Levi-Faur (ed.), 2012, Part VII.

¹⁶⁹ We list others in Part III.A in relation to the work of the TDC, that extend to other Working Groups as well.

¹⁷⁰ *See*, for example, Columberg, 1997; Parvin, 2017; Kaim, 2021; Escobar, 2017. Moore, 2014. A conversation with the flourishing literature on the subject presents an exciting area for future research, particularly as numbers grow and Auroville is faced with these issues at somewhat of a representative scale.

¹⁷¹ Sri Aurobindo, CWSA, 1997, Vol. 6-7, 296.

¹⁷² Sri Aurobindo, CWSA, 1997, Vol. 6-7, 968.

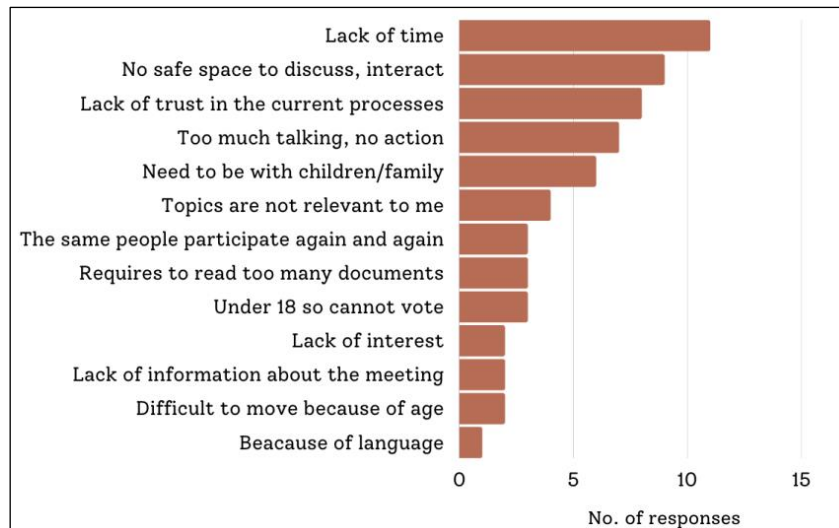

(Randomized survey response, ‘what prevents you from participating in community meetings?’. *Source*: Citizen’s Assembly Pilot Report, 2021, 12-3)

These are broadly representative reasons one would expect behind a democratic deficit.¹⁷³ The question of how Auroville responds is interesting. We take a cue here from Parvin’s review of the literature, which documents the turn to political disengagement along the lines charted above, but with a realistic suggestion that instead of pushing for *more* engagement through time-consuming and not necessarily informed modes of direct participation, we may consider other forms to secure democratic principles that demand *less* of residents:

Changing patterns of political participation observed by political scientists over the past half-century undermine traditional democratic theory and practice. The vast majority of democratic theory, and deliberative democratic theory in particular, either implicitly or explicitly assumes the need for widespread citizen participation. It requires that all citizens possess the *opportunity* to participate and also that they *take up* this opportunity. But empirical evidence gathered over the past half-century strongly suggests that many citizens do not have a meaningful opportunity to participate in the ways that many democratic theorists require, and do not participate in anything like the numbers that they believe is necessary ...

[We must] seriously the failure of the strategies adopted by many states to increase participation ... and [consider] that instead of requiring more of citizens, we should in fact *be requiring less of them*. Instead of seeking to encourage more citizen participation, we should acknowledge that citizens will probably not participate in the volume, or in the ways, many democratic theorists would like, and that therefore we need an alternative approach: a regime which can continue to produce democratic outcomes, and which satisfies the requirements of political equality, in the absence of widespread participation by citizens.¹⁷⁴

The question, particularly as Auroville grows in numbers, will be to better understand the *nature* and *volume* of participation that is suitable for its action: it is not necessarily true that pushing for greater participation in an assembly structure that places heavy demands on time and knowledge in sectors beyond one’s competence, particularly in relation to matters that

¹⁷³ See, Fischer, in Levi-Faur (ed.), 2012; Parvin, 2018; Fischer, 2009; Osmani, 2007; Platteau, 2007.

¹⁷⁴ Parvin, 2018, 31.

require technical expertise, is either practical or philosophically astute.¹⁷⁵ It ill-accords too with Mother's suggestion for illumined hierarchies, which we incorporate in our suggestions below.

The natural response to democratic deficits is to widen participation – yet we suggest that Auroville may reconsider, indeed innovate, the modes by which it is to be effectively secured.¹⁷⁶ Effective participation and deliberation may not, indeed most likely is not, best secured by a proliferation of assembly-like structures. Based on our limited interviews, the concern voiced was not how one can get a greater say in the assembly, but how one can effectively minimize time spent there, for essential matters, to focus time and energy on one's work. The common refrain of 'more committees, more useless talk', bluntly put in the TDC Annual Development Plan, 2014-15, documents an odd phenomenon in Auroville: there is too much and too little participation. Too much in terms of quantity, too little in terms of quality and effectiveness. The remarks of the Governing Board in its 58th meeting that there 'is a proliferation of groups and discussion forums', with an 'inability to put decisions into practice' holds true in our review in Part III. The governance question in relation to the Residents' Assembly, and more broadly, is to encourage participation, to harness the collective wisdom in ways that are optimized and channelized, not inflated. Practical expressions of 'deliberative democracy' require clear specifications of *what* issues can be the subject of deliberation in an assembly, the *nature* of such deliberation, particularly its format, time-boundedness and reliance on expertise, and finally, *bindingness* of those decisions once made. As Gutmann and Thompson note:

... the deliberative process is not like a talk show or an academic seminar. The participants do not argue for argument's sake; they do not argue even for truth's own sake (although the truthfulness of their arguments is a deliberative virtue because it is a necessary aim in justifying their decision). They intend their discussion to influence a decision the government will make, or a process that will affect how future decisions are made. At some point, the deliberation temporarily ceases, and the leaders make a decision.¹⁷⁷

A distinction here needs to be made between formal and informal deliberative channels, key to democratic theory: formal channels are incorporated in legislative bodies, the Residents' Assembly and as we suggest below, Zonal Assemblies; the informal channels are incorporated in the confederation of 'mini-publics', the paradigmatic 'public space' that is organized across small fora for friendly, easy interchange untied to formal decision-making. The latter, as we discussed above, constitute an extra-political sphere, where vibrant deliberation, indeed 'proliferation' is valuable – these are the spaces where 'political awakening and widening' occurs to borrow Sri Aurobindo's articulation. This is all the more so as numbers grow, and Auroville becomes more diffuse, bringing in tow an inevitable weakening of collective bonds and the threat, as Sri Aurobindo articulated in relation to older city-states, of a concentration of power in a minority. This sentiment, expressed often in our interviews, seems to be the

¹⁷⁵ See, Khwaja, 2004; Osmani, 2007; Papadopoulus and Warin, 2007. This merits a deeper examination of the nature and methods of engagement across subject-areas, particularly as between technical and non-technical matters.

¹⁷⁶ See, for general discussion on this point, Crouch, 2004; Norris, 2011.

¹⁷⁷ Gutmann and Thompson, 2004, 5.

underlying fear for centralization of authority in the legislative assembly or Working Groups – as Bartram summarizes:

As the state becomes larger and more diffuse, and as citizens become more distant from one another both spatially and emotionally, so the government of the republic will need a proportionally smaller and more cohesive group of magistrates if its rule is to be effective. Rousseau thinks it almost inevitable that this group will end up usurping the legitimate sovereign power of the people and substituting its corporate will for the people's general will.¹⁷⁸

As numbers have grown, centralization presented itself as a *practical* necessity for effective decision-making; yet the fears of centralized authority, outlined above, have persisted, resulting in a state of diffused, loosely organized small-groups without effective decision-making channels. This concern is not exceptional to Auroville – global debates document a plethora of policy tools in response to popular demands to relocate power in the community. As Landemore notes, 'effective participation means that there must be a direct connection between popular involvement and ultimate decisionmaking' – *yet*, popular opinion cannot remain in a state of nebulous or repetitive dialogue, an interminable process of conversation that does not lead to action. There must be a *connection* between popular involvement in the extra-political sphere – the 'numerous' and 'non-gigantic' associations that constitute the mini-public discussed above – and the formal decision-making fora, the Assembly, but the two are not, indeed cannot be, the same at scale.

Literature attests to the need for a porosity between the two channels, as members of the representative assemblies are not to remain insulated, but be guided by the agenda set in participatory fora. Yet, for a democratic setup to operate at-scale, this diffused and vibrant deliberation *must* lead to decision-making in the formal fora of representatives: 'the leaders make a decision'. The imprecise articulation of these formal and informal channels, alongside a conflation of legislative and executive functions, has led to the valid demand for direct participation resulting in delayed decision-making and ineffective implementation with a cycling of proposals and repetitive dialogue across sectors as our review in Part III demonstrated.

To put it simply, this is where the shoe pinches in Auroville's governance: the community may and must deliberate vigorously and inclusively; yet, as Sri Aurobindo pointedly notes at various points, the inefficiencies and delays attendant to this method may be fatal, as indeed is the case in Auroville in key sectors: '... a more democratic democracy ... might be fatal to efficiency in anything so complicated as the management of the affairs of the world.'¹⁷⁹

This is now a well-rehearsed criticism of participatory methods – a variety of democratic models, preceded by an assortment of adjectives (participatory, deliberative, dialogic, organizational, agonistic, decentralized, inclusive, transformative, communicative democracy, among others), have each attempted to balance the twin concerns of participatory and efficiency.¹⁸⁰ A detailed discussion of these models is beyond our scope – simply put, we may

¹⁷⁸ Bertram, 2003.

¹⁷⁹ Sri Aurobindo, CWSA, 1997, Vol. 25, 473.

¹⁸⁰ See, for a sympathetic review, Fischer, 457-467, in Levi-Faur (ed.), 2012; Landemore, 2012.

say that participation enhances popular legitimacy and may, under certain conditions, enhance the pool of collective intelligence, but inevitably complicates and slows down the decision-making process, at times with gridlocked delays. It is unsurprising then that participatory processes in Auroville – the 2005-9 Dreamcatching forum, 2009-13 ISP, 2015 Retreat and 2021 Citizens' Assembly Pilot, for example – each valuable initiatives, did not produce decisive outcomes or actionable plans. Similarly, plans proposed by Schmidt, Billinger and Anger, 2001/2003/2005, Kundoo, 2007, ISP, 2010, Stein and Stein, 2013, Feduchi, 2014, Kalra, 2014, Andrea, 2018, Ayer et. al., 2009, 2013 and 2019 and others over the years have remained in a state of limbo, neither decisively rejected nor accepted, but in a state of constant 'discussion'.

Going back some years, Anger spoke of his dissatisfaction on this count: 'everything in Auroville can be contested now ... All these have become false arguments which lead to us a dead end ...'¹⁸¹ Indeed, one may re-print the January 1997 issue of *Auroville Today*, which identifies the 'lack of planning' and 'lack of an enforcing authority' as factors that 'frustrate town-planning', as current commentary. Thomas and Thomas' exasperation in a 2015 interview, eight years after the publication of their study, sums up the issue:

... when we sought clarifications there were many opinions, and very often there was no answer to a specific question or no decision was taken. That was frustrating. I think this is a particular problem here. At some stage a decision has to be taken; you can't endlessly debate.¹⁸²

Unsurprisingly then, the TDC's Annual Development Plan, 2014-15 identifies this participatory limbo as a primary 'developmental blockage', one that has driven an apathy amongst residents to engage in the public process if debate is unlikely to result in action:

Difficulty to harness residents support to embark on action-oriented planning practices and a collaborative governance system. Lack of clear responsibilities, over reliance on committees and not on capable individuals. 'More committees, more useless talks!' This leads to a disinterest on the part of capable Aurovilians to come forward and shoulder responsibilities at community level.¹⁸³

We may, on a tangent, refer here to an interesting short exchange in the *Agenda* on the construction of the Matrimandir, dated 10th November, 1971. When Satprem informed Mother that an architect had begun work 'after consultation with about 50 Aurovilians', Mother replied: 'Listen, those things are enough to drive anyone crazy!'¹⁸⁴ A similar sentiment, of 'going crazy' with 'interminable talk', was expressed often in our interviews. It is interesting to note that in Mother's early stewardship of the project, when contrary views were presented to her in the course of consultations, she invariably identified one person whom she considered most competent – often Anger or Shyam Sunder – to decide matters finally: this, we may say, was her working of the qualified, democratic principle along the lines 'illuminated hierarchies with collective discipline'. Naturally, Mother's authoritative presence and small numbers at the

¹⁸¹ Majumdar, 2017, 238.

¹⁸² *Auroville Today*, January, 2016, 7.

¹⁸³ TDC, Annual Development Plan, 2014-15, 10.

¹⁸⁴ Guigan, 2018, Vol. 2, 288-90.

time rendered decision-making relatively easier than it is today and will be in the future; yet the principle remains the same.

What is required then is leadership and an institutional form that enables and channelizes participation in a culture of decisive action. The value of participation, we may suggest, is tied to five factors: how meaningful / inclusive, effective, informed / competent, quick and conclusive it is. Accordingly, the ideal of deliberative or participatory democracy – of an engaged population, conducting what we discussed above as extra-political, informal, local discussions in small and numerous public spaces – is much needed; yet without effective and liberal centralization of authority to make the final decision informed by the general will that emerges from this dialogue, what results is not Divine, but human, anarchy. An insipid flurry of ideas without a dynamic and concentrated vehicle to translate them into life. Our suggestion to balance these concerns, in a simple, inclusive and effective governance framework, is four-fold: (i) a representative Residents' Assembly, with (ii) federated Zonal and where necessary, sub-Zonal assemblies, (iii) procedural rules for effective deliberation (iv) a city-wide continuous education portal for informed deliberation within the community, untied to formal decision-making channels, and (v) a distinction between legislative and executive tasks. We outline these below.

b. Representative and Federated Assemblies

The natural response to ensure democratization at scale and complexity is institutionalizing representation. Parvin's suggestion, in the passage quoted above, was a recognition of the fact that the democratic impulse to increased direct participation, well-intentioned as it may be, ill-accords with settled evidence that individuals do not have the time, inclination or capacity to devote themselves to the complex matters of legislative deliberation, even leaving aside the considerable institutional concerns of ordering this kind of *en masse* participation effectively. Both considerations are empirically verified in Auroville today. Parvin's remarks resonate in this context:

The challenges posed by political disengagement, participatory inequality, and low political knowledge among citizens are better dealt with through a strengthening of *representation* over *participation* because such a strategy need not require citizens to act and think in ways that empirical data gathered over the past 70 or so years tells us they do not or cannot. It is also less demanding in terms of the information that citizens need in order to participate in the relevant ways, and it can produce fair and legitimate outcomes in the absence of widespread participation or even engagement among citizens. This is a foundational, rather than accidental, quality of representative democracy which emerged at least partly out of the need to make democracy compatible with the increasing diversity, size, and complexity of modern mass societies. As mass societies became too large to allow for direct participation in decision-making by each and all citizens, so new structures had to be conceived to better track the preferences of the citizenry and ensure freedom and equality through self-government. The rise of representative democracy was thus in part a *pragmatic* response to the new challenges posed by modernity, but it was also a coherent *philosophical* response to the fact that the participatory model of democracy no longer fits the world. The transition from direct to representative democracy embodied a shift in democratic theory and practice about what kind of institutions

could hope to make good on democratic principles of freedom, equality, and self-government given the world as it is. The appeal of representative democracy was not then, and is not now, merely that it provides the most practical response to the deep and wide changes that characterise modern states, although it does so. It is that it is the best philosophical approach we have thus far come up with capable of making good on democratic principles in the modern era.¹⁸⁵

The connection between deliberation and representation is much debated and theorized.¹⁸⁶ The issue can be seen along five axes: the first is the practical necessity of representation at scale given the logistical burdens of direct participation; the second is the philosophical necessity of representation at scale given the cognitive burdens of direct participation, particularly if public affairs concern matters of technical skill and expertise; the third is the entrenchment of a political class of representatives, an electoral dictatorship, that further deepens the deliberative disengagement; the fourth is balancing representative democratic forms at the central level with direct democratic forms at the ‘local’, ‘decentralized’ level in a federated setup, and the fifth is developing models of participatory consultation or engagement within a representative setup to allow for a responsive, circular channel of communication between the community and its representative. We offer brief reflections on these issues in the context of Auroville, where representative forms have been proposed yet not implemented since 2001, to suggest pathways that offer promise. None are free of serious concerns, yet, in our view, still worth the attempt.

The democratic social contract demands equal participation, yet the logistical burdens of direct participation outlined above usually require that the will and share of each be practically represented by a single individual, the selected or elected representative – the mandate of self-rule is translated here into a model of participation by proxy, as a practical resolution for a workable democratic setup at scale. But there are further, and more involved, philosophical reasons to this representative model: that the *demos*, the ‘people’, by themselves lack the coherence and concreteness required to develop a unified will – a guiding presence, of the representative, to formalize and develop these views, negotiating the diversity and disagreement natural to any healthy, functioning and free society, is required to allow for the emergence of a general position. A state of everyone governing everyone, in Bentham’s articulation, ‘would be – not government, but the absence of all government.’¹⁸⁷ Prudential concerns of stability thus demand a representative who can, if virtuous and competent, rally for the emergence of a unified whole.

Still further, there is a deeper, perhaps more controversial but in our view valid reason behind the institution of representative forms of government, one hinted at in Mother and Sri Aurobindo’s writings: the ‘tyranny of the majority’. This much-debated idea echoes a concern that the popular will may not be a considered, reflective reflection of the best course of action, but driven by fickle sentiment and ‘mere opinion’. This goes back to the critical issue discussed above of the centrality of inner development and education, that is a ‘psychological clarity, a diffused reasonableness and scientific intelligence and, above all, a moral elevation and rectitude’ amongst the *demos*, to which ‘neither the mass of mankind nor its leaders and rulers

¹⁸⁵ Parvin, 2018, 45 (emphasis in original)

¹⁸⁶ See, *in general*, Pitkin, 1967; Coffman, 2015 for a contrary take.

¹⁸⁷ Quoted in Vitali, 2021, 1319. See also, for a discussion on delegate and trustee representative forms.

have yet made any approach.¹⁸⁸ The concern – what one scholar calls the ‘dirty secret of democracy’ – simply is that enlightened participation from below may not obtain as easily as we would like, and a representative form is thus not only practical but also philosophically astute to counter the excesses and limitations of popular will. Many in Auroville have argued along these lines, in relation to the modes of decision-making in the Residents’ Assembly and Working Groups.

A long-tradition bears witness to this strain of thinking, of an ‘elite’-guided political rationalism (or in Auroville’s case, intuitive governance) from above. A deeper discussion on the motivations and mechanics of this approach would be helpful, but for their part, Sri Aurobindo and Mother’s counsel supports this view. Mother’s qualified support for democracy in Auroville is reflected in the principle of ‘illuminated hierarchies with collective discipline’ – this requires the identification of an enlightened centre, or in other words, a ‘representative’. The concern that motivates Mother here, as indeed many in the past, is a balance between general participation and governance by the intuitive few. Numbers, as she noted, do not guarantee truth, yet equally, for each to be subject to their own authority, the key to the subjective move, the equal participation of all in some form seems pressing. On his part, Sri Aurobindo addresses this concern by referring to the ‘ideal of free cooperation’ amongst individuals, the democratic principle, ‘guided and helped by a wise ... authority’, a form again of representation:

Under a just social order, there must be an equal opportunity, an equal training for all to develop their faculties and to use them, and, so far as may be, an equal share in the advantages of the aggregate life as the right of all who contribute to the existence, vigour and development of that life by the use of their capacities ... this need might have taken the form of an ideal of free cooperation guided and helped by a wise and liberal central authority expressing the common will ...¹⁸⁹

In Chapter XXIII of his *The Ideal of Human Unity*, entitled ‘Forms of Government’, an important anchor for deliberations on governance in Auroville, Sri Aurobindo elaborates this idea further. In a long passage, worth quoting at length, he suggests representative forms – ‘delegates’ – though not without an important caveat, in which really lies the nub of the debate and the challenge for Auroville to solve as an ideal collective:

Centralised, it would delegate some of its powers to national authorities and councils, but only as the centralised French government Parliament and bureaucracy delegate some of their powers to the departmental prefects and councils and their subordinate officials and communes ...

In two directions it may lead to a new form of modified oligarchy with a democratic basis. The government of a modern society is now growing an exceedingly complicated business in each part of which a special knowledge, special competence, special faculties are required and every new step towards State socialism must increase this tendency. The need of this sort of special training or faculty in the councillor and administrator combined with the democratic tendencies of the age might well lead to some modern form of the old Chinese principle of government, a democratic organisation of life below, above the rule of a sort of intellectual

¹⁸⁸ Sri Aurobindo, CWSA, 1997, Vol. 25, 396.

¹⁸⁹ Sri Aurobindo, CWSA, 1997, Vol. 25, 383.

bureaucracy, an official aristocracy of special knowledge and capacity recruited from the general body without distinction of classes. Equal opportunity would be indispensable but this governing elite would still form a class by itself in the constitution of the society.

If any of these things were done, any movement towards ... [centralization] would then take the same direction and evolve a governing body of the same model. But in these two possibilities we leave out of consideration the great factor of ... the conflicting interests and tendencies it creates. To overcome these conflicting interests, it has been supposed, the best way is to evolve a sort of ... Parliament in which, it is to be presumed, the freely formed and freely expressed opinion of the majority would prevail. Parliamentarism, the invention of the English political genius, is a necessary stage in the evolution of democracy, for without it the generalised faculty of considering and managing with the least possible friction large problems of politics, administration, economics, legislation concerning considerable aggregates of men cannot easily be developed ... Nations emerging into the modern form of society are therefore naturally and rightly attracted to this instrument of government. But it has not yet been found possible to combine Parliamentarism and the modern trend towards a more democratic democracy; it has been always an instrument either of a modified aristocratic or of a middle-class rule.¹⁹⁰

A careful parsing of Sri Aurobindo's words here is useful. He identifies three issues: first, the necessity of a vibrant and informed public dialogue, the participatory or deliberative ideal, which can result in a 'freely formed and freely expressed opinion of the majority'. Second, he recognizes the need for Parliamentarism (which assumes representative forms), at least as an interim vehicle, a 'necessary stage' Auroville has yet to pass through, without which the 'large problems' of city-building in at-scale 'considerable aggregates' cannot be dealt with without friction. And third, he recognizes the tension between the popular will of the majority ('equal opportunity would be indispensable') and the 'governing elite', characteristic of representative capture of governance ('modified aristocracy' or 'middle-class rule', the tyranny of the majority) where a combination has yet to be found. Representation thus appears necessary, but with concerns that require careful handling.

The usual functioning of Parliamentary or representative forms of democracy is troublesome – the selection or election of the representatives results in a disengagement of the *demos* from the centre of power – as Landemore notes, 'representative democracy is under attack precisely for being representative and keeping ordinary citizens at arm's length of the real site of decision and power.'¹⁹¹ This results in the form of 'semi-passive democracy' Sri Aurobindo speaks of, where the link between the representatives and the represented is weak, such that 'the sole democratic elements are public opinion, periodical elections and the power of the people to refuse re-election to those who have displeased it.'¹⁹² The well-known paradox of representation must be avoided in Auroville: an elected, and only nominally democratic, oligarchy results, with the usual mechanics of party politics, lobbying and canvassing, in which an illusion of limited choice is presented to the residents:

¹⁹⁰ Sri Aurobindo, CWSA, 1997, Vol. 25, 472-3.

¹⁹¹ Landemore, 2017, 51. *See also*, Landemore, 2016.

¹⁹² Sri Aurobindo, CWSA, 1997, Vol. 25, 471.

... neither effective participation, nor agenda-setting, nor enlightened understanding are credibly ensured by the mere ability to elect one's leaders every four years and, in between, publicly criticize their decisions from outside the sites of decisive power. Representative democracy does not, in theory, require any form of popular participation besides voting and, because it also does not credibly accommodate, let alone commit to, agenda-setting by ordinary citizens, it even weakens voting as a form of effective participation. Access to power is only possible through becoming elected, a path that, even in theory, is open only to people endowed with certain qualities and, in practice, is mostly restricted to people with either money or connections. Nor does representative democracy require or guarantee enlightened understanding on the part of citizens. On the contrary, periodic elections and the independence of representatives are intended to compensate for the assumed absence of popular enlightenment about political issues. On certain 'realist' versions of representative democracy, no room is made for democratic deliberation among ordinary citizens as a vehicle for individual and collective enlightenment, since the latter is seen as either pointless or even counterproductive.¹⁹³

Put simply, representation carries risks of concentration of political power in an entrenched political class, which sits uneasily with the democratic ideal, let alone the high ideal of 'spiritual anarchism' to which Auroville aspires as a reflection of the self-authenticating authority of each over herself. Naturally, this is not the form Auroville should consider. Though, with the erosion of trust in the Residents' Assembly and Working Groups, many have argued over the years that it is what has resulted in practice.

In an interesting discussion on this point in 2001, Professor Joshi, the then Chairman of the Governing Board, navigated between these concerns. He began with a criticism of parliamentary forms:

There is a very interesting account of democracy given by Laski ... And he says that parliamentary democracy... he was himself a great democrat, but he has made a scathing criticism of parliamentary democracy. He says, the individuals who represent or who pretend to represent individuals, which individual do they represent? Can anybody represent another? This is a basic question. Who can represent every individual, you tell me, each individual is a spark of the divine will. Who will represent this individual? And supposing, your individuals who have sent you, change their opinion, what will happen to you? What is your representation? Is there something like a common will of all the individuals: will of A + will of individual B + will of individual C? Is it ever possible to have made a kind of calculus of this kind? So right at the very bottom, even theoretically, parliamentary democracy is based upon some kind of compromise and falsehood. So my request is that we are here to make a very detailed research — this is what I mean by advanced research. And Mother says that in life we have to make a research. We have to make and see surely that ultimately the Residents' Assembly is really a Residents' Assembly. It is not a representative assembly. It is Residents' Assembly and don't compromise on it. It is an assembly which looks after each and every individual resident. We have to arrive at that point where each individual resident is awake, he is alive and he is very keen, as Sri Aurobindo says, to perfect himself and to aid and to be aided by others' perfection. This is the stage where we should reach. And the Residents' Assembly is

¹⁹³ Shapiro, 2017.

an instrument for springing into this. As long as individuals are simply put aside or simply taken up sometimes for getting their opinion, it is a mask and it is very inadequate and very, very unsatisfactory form of service to the divine consciousness. This is my reflection, it might be unpopular, but I must say what I feel personally.¹⁹⁴

However, he qualified his remarks as follows:

There is a suggestion that you should have a parliament consisting of thirty people chosen by the Residents' Assembly. That is one of the suggestions which have been made somewhere. Now one of the difficulties in Auroville that I find is choosing — and there is a lot of confusion on this subject: shall we vote, shall we not vote, shall we nominate, what shall we do? There is also an argument that Residents' Assembly consisting of at least one thousand people or more — this is a very unwieldy number, even if you bring them together at one place, it is a very difficult thing to have a debate and so on. I am not very sure but even if you need to have a smaller body, I'm not at all opposed to have smaller bodies representing a larger body but again you remember my word on representing. Don't call it a representation because that is not a very true state of affairs. You cannot represent, but you can say that for the sake or convenience of work, you can have smaller groups.¹⁹⁵

What emerges from this short discussion, consistent with ours above, is the recognition of the practical necessity of representation, yet a caution that it must not translate in Auroville to the usual forms that are attendant to such a system. These objections against representative forms have been levelled with great force in recent literature. Yet, we suggest that the institution of representation can be operated in Auroville to reflect its practical and philosophical principles, those of working at scale and allowing for 'wise guidance', without allowing for an electoral Residents' Assembly where residents periodically participate. Three points are important here.

First, we must distinguish between two meanings of the term 'representative': as a majority proxy, a 'delegate' elected by an aggregative counting of preferences (disclosed by voting or any other means; what Professor Joshi refers to as 'will of A + B etc. '), and as a 'trustee' or leader, emerging from the community, 'an enlightened centre', guiding and reflectively assisting in the emergence of a unified will as far as possible.¹⁹⁶ The latter is consistent with Mother and Sri Aurobindo's guidance, as also Professor Joshi's important counsel. The delegate model, a spokesperson, as it were, standing in proxy for the majority is unsuited to Auroville, not least because of Professor Joshi's incisive remark that true representation of one's views, let alone of a collective, and not simply a nominal aggregation of the preferences of each by vote, is a difficult enterprise. This will inevitably yield to 'politics', the messy game of numbers, charisma and electoral promises that Mother emphatically rejected: 'Auroville is not a place for politics; no politics must be done in Auroville and not in the offices of Auroville.'¹⁹⁷ In fact, the reference to elections in the Residents' Assembly was consciously

¹⁹⁴ Joshi, 2001, 20.

¹⁹⁵ Joshi, 2001, 24.

¹⁹⁶ There is a vast and complex literature on the subject, beyond our scope here, with which Auroville can profitably converse in its own systems design. *See*, for example, Pitkin, 1967; Rohrschneider and Thomassen (eds.), 2020; Dovi, 2007; Dovi, 2016. For the original articulation of the 'trustee' model of representation, *see*, Burke, 1968.

¹⁹⁷ Guigan, 2018, Vol. 2, 458.

excluded from the AVF Act, 1988. Following Professor Joshi, Auroville must guard against the predictable outcome of this model:

Individuals are put aside in whose name the democracy actually has come into being. All democrats speak in the form of individuals as if they are the greatest advocates of individuals. But each candidate in the Parliament says: I am the representative of individuals. So all individuals are thrown into the background. Individuals are in the background. I, I am the representative.¹⁹⁸

By contrast, the trustee model – one with long theoretical antecedents, but limited practice – is particularly suited to Auroville. A trustee is not simply an agent of the community, expressing the aggregated majority preference in the Residents' Assembly. Rather, she is a guardian of the values of the whole, tending to the concerns of each and if necessary, exercising her power to lead, guide and disagree with the community in dialogue. The trustee elected by each community in this case does not 'represent' them in the Residents' Assembly in the usual sense of the term, with representatives each colliding. She reflects the concerns of the part to the whole and those of the whole to the part – an 'enlightened' link between members of the community in diverse walks and zones, who may not necessarily interact with each directly on a daily basis. Mother had indeed described the need for a resident of this sort who could build cohesiveness:

The atmosphere is dislocated; it has lost the cohesive power it had. But if you want to collaborate, it would be wonderful, you know! I need someone, you see, someone who could get around, talk to people, see, take notes: re-establish unity on a higher level.¹⁹⁹

Naturally, whether one labels this member as a trustee or a delegate is not determinative: the natural tendency to pull the collective in one's favour, the 'ordered conflict of interests' borne of the *rajasic* modality will necessarily appear, with open or disguised attempts at semi-electoral representation – the institutional form we suggest here may signal and facilitate a movement away from elected, aggregative representation to non-elected, emergent trusteeship from each community, but the matter will ultimately depend on the conventions and cultural practices that emerge from within communities when they operate this model. Whatever the institutional model, Auroville will have to guard against the natural tendency of a creeping, *de facto* party politics / group-based voting preferences that harden differences across scale. This is visible already in some quarters, as the Governing Board noted in the minutes of its 57th meeting and some records indicate.

Second, to facilitate the practice of this ideal, the selection of this trustee-representative is not by election, but by emergence from each community according to practices that it is left free to decide upon. In a different context, Sri Aurobindo suggested that a democratic equality of all, if operated under true conditions, can allow for the emergence of 'a natural leadership and

¹⁹⁸ Joshi, 2001, 19.

¹⁹⁹ Guigan, 2018, Vol. 2, 331.

influence to differentiate by a freely accorded greater weight and voice.’²⁰⁰ If the principle of ‘illuminated hierarchies’ is to be given an honest go, the institution of the trustee model offers a form for the community to attempt the experiment. This assembly of enlightened centres, representative of each of the zones, can operate as the ‘wise and liberal central authority expressing the common will.’ In the ideal, as Urbinati notes, a deliberation in such a concentrated assembly has distinct advantages *if* a strong linkage, a porous boundary can be developed between the formal track of representatives in the Residents’ Assembly and the informal track of residents, in each zone and sub-zone, having close contact with that representative. The representative is the sluice gate between the two. This is something that the federated, zonal architecture proposed above can help achieve, relatively easily at current numbers and also at the scales Auroville will expect in the future:

... a smaller number of representatives allows for a reflexive delay between the expression of raw judgments and preferences, on the one hand, and crafting of policy outcomes, on the other. Representation also allows a circular process of communication between representatives and the represented.

[the proper working of this system] ... assumes a reflexive and smooth circularity between the sphere of opinion formation through which ordinary citizens exchange ideas and form views in decentralized and unregulated ways and the sphere of the formal will expressed by ... representatives ... Yet the dichotomization between the spheres of opinion and will operates as, or at least tolerates, *de facto* closure of [the Residents Assembly] ... to [residents]. In Habermas, the ‘sluice’ metaphor that is supposed to capture the relation between the two deliberative tracks (the formal and the informal) similarly suggests a filtering mechanism separating the unstructured deliberations of the people from those of elected elites. In the end, such dichotomies [may] function as a way to close off the sphere of actual power and effective deliberation to ordinary citizens.²⁰¹

We thus suggest that each sub-zonal or zonal group (which we speculatively delineate below) can select a trustee for the Residents’ Assembly, which no longer meets *en masse* but through this union of trustee-representatives, ‘enlightened centres’ from across zones. This said, there is in any representative setup a residuary concern that the distance between the representatives and the community will widen, resulting the problem of enlightened despotism discussed above:

What happens when the relationship ... between representatives and represented no longer seems a plausible or normatively appealing theory of the way things work and ought to work, in particular because it is no longer credible that the informal public sphere can set up the agenda for the more formal one? What happens when representation no longer is democracy, as Plotke has it, but becomes instead, as Rousseau warned long ago, its very demise?²⁰²

²⁰⁰ Sri Aurobindo, CWSA, 1997, Vol. 25, 643.

²⁰¹ Landemore, 2017, 53, 56-7, *in passim* for a discussion on representation and deliberation.

²⁰² Landemore, 2017, 53.

The answer can perhaps only be that the fragility of representative democratic practices requires constant renewal through informed participation – one may hope that the federated models allows for sufficiently compact collectives that permit this bottom-up renewal without demanding a participatory burden on the part of residents. Safeguards naturally remain in place through the authorization of representatives, renewed at periodic intervals if that gap widens too far.

Third, as we discussed above, a confederated network of smaller aggregates – zonal and sub-zonal groups that act as the units for one’s local affairs on a day-to-day basis – may allow for such trustee-representatives to emerge naturally born of connect. The smaller the unit, the greater the chance that the trustee-representative will have an informal, personal connect with each resident and be truly able to listen, participate, lead and guide. This institutional design, outlined above, follows Sri Aurobindo’s dynamic of developing ‘small free units’, each sub-zonal unit that selects a trustee, coming together progressively in a ‘large concentrated unity’, the Residents’ Assembly. In his discussion on ‘Forms of Government’, Sri Aurobindo points, alongside the representative model, to a ‘close federation or a simply confederacy’ as a viable model for the organization of collectives. Though he is speaking there at the large-scale of a nation-state, we may scale down the dynamic with appropriate modifications to apply to Auroville (particularly as numbers grow):

I have tried to show from the analogy of the past evolution ... that this ... unification must culminate or at least is likely to culminate in one of two forms a looser ... union which may be either a close federation or a simple confederacy of the peoples for the common ends of mankind. The last form is the most desirable, because it gives sufficient scope for the principle of variation which is necessary for the free play of life and the healthy progress of the race.²⁰³

The question for Auroville is how the ‘close federation’ or ‘simple confederacy’ principle can be manifested. Mapping this form on the spatial arrangement of the city, to balance the twin forces of free play / diversified decentralization and unification / centralization, Auroville may consider a federated model comprising Zonal and sub-Zonal Assemblies, where residents of each zone / sub-zone can directly participate. The concern with burdensome, at-scale participation may accordingly be addressed in this federated model – as we discussed above, this model offers distinct advantages in the organization of the collective, allowing for the emergence of smaller units where daily exchange and contact is likely. Placing this in the context of Zonal and sub-zonal assemblies, smaller collectives can work around the problem by providing residents a forum where decision-making is tied to a common experience of *action*. Decisions emanate from those bound together in collective *work*, which generates greater shared reference points and sympathy.²⁰⁴ If decision-making is not located at this level, and the frustration with larger assemblies persists, Taylor insightfully notes that two facts of political life take on ‘greater and greater saliency’, judicial battles and interest-group or advocacy politics, both reflected in Auroville today. By contrast, one hopes that these federated assemblies will be a more ‘manageable unit of life’, where the problems of scale, participation

²⁰³ Sri Aurobindo, CWSA, 1997, Vol. 25, 574.

²⁰⁴ There is a deep literature on this subject, which we can only point to see. *See*, for example, Taylor, 283.

and conflict of interest may be dented by a ‘closer intellectual, cultural and physical intercourse.’²⁰⁵

In sum, we suggest the following restructuring of the Residents’ Assembly:

- i. Each Zone has its own assembly, comprising all residents, with sub-zonal assemblies, as numbers grow, particularly for zones with large numbers, like the Residential Zone.
- ii. These assemblies may legislate on matters concerning their zone / sub-zone, as for example, the policy for housing, industrial growth, research and education policy etc. to allow for informed, effective and manageable participation amongst those who are in daily interchange.
- iii. Representation to the Residents’ Assembly from each zone, along the trusteeship model, for decision-making on city-wide matters, to allow for manageable and coordinated action on issues that concern all or more than one zone.
- iv. As we note below, a Zonal Group as the executive arm for each Zonal assembly, responsible, with the Working Groups, for the drafting and implementation of Detailed Development Plans for each Zone in accordance with the policy mandate. This may allow for a distinction between the legislation mandate of the Zonal Assembly and executive mandate of the Zonal Group, and meaningful participation through a federated executive structuring between the Zonal Groups and Working Groups.

As numbers grow, we suspect that some experimentation along these lines will become necessary for a more realistic assessment of the (nominally) direct democratic setup of the Residents’ Assembly. If considered viable, a division of functions / areas of legislative competence between the Residents’ Assembly and Zonal Assemblies will have to be detailed out. We do not enter that practical exercise here.

iv. Aggregating Interest, Consensus and Veto

Whatever may be the institutional model for the operation of the Residents’ Assembly, the underlying concern persists: how are policies, plans and projects to be adopted by such an assembly? Is it through voting, consensus, the ‘mood of the house’ or otherwise? There is a mechanical question here, as to the manner in which opinion is solicited – mechanism of votes, anonymous or public, immediate or with a lag to allow for reflection etc. – and the issue Prof Joshi referred to above, of what the popular will itself means in Auroville. We address the former in our procedural suggestions below, and offer brief reflections on the latter.

a. Expanding the Circle of Interest

As Professor Joshi noted, aggregating preferences – the will of A plus B plus C and so on – to arrive at the common decision, the process normally adopted in Parliamentary systems is naturally unsuited to Auroville for reasons discussed. It is a practice adopted regularly but

²⁰⁵ Sri Aurobindo, CWSA, 1997, Vol. 25, 403.

reluctantly in Auroville, with a preference for consensus amongst all residents, an expression of a unified will. This is the principle of fraternity in action and has naturally been a difficult one to operate in practice, with a diversity of viewpoints resulting often in intractable disagreement. The hope, against hope in some ways, for non-coercive consensus in democratic systems has been voiced over the years, particularly with a sentimental demand in anarchist systems.²⁰⁶ The move from an aggregative or majoritarian system is partly a question of institutional dynamics – where the trustee model may partially assist in facilitating the emergence of a common will, if there is operated well – and partly a question of culture.

A preliminary caveat is in order here: this is the caution, following Schumpeter and Bentham, that a single concrete, unified will amongst all risks being a constructed fiction – at scale, even at 3000 residents, the complexity of individual views, which may each change over time, and the gulf between what is expressed publicly and what is felt privately, means that arriving at a single, common will may be a passive, rather than active, common will. To say that, ‘everyone accepts this decision’ is a statement that may be possible only a level of generality that hides a deeper diversity of views. This is the concern Professor Joshi voiced above, when he pointedly asked: ‘Is there something like a common will of all the individuals: will of A + will of individual B + will of individual C? Is it ever possible to have made a kind of calculus of this kind?’ This kind of a common expression is perhaps only possible in smaller collectives, where the depth of engagement between residents can be captured in deliberations – our proposal above for the organization of governance frameworks along smaller sub-zonal and zonal collectives is with a view to allowing for the possibility of something approximating a common will to emerge, something is highly unlikely in an *en masse* meeting.

More substantively, the aspiration of consensus reflects a deeper debate on how one conceives of the Auroville collective, whether as an aggregation of individuals, each expressing (by vote or otherwise) their preferences or interests (loosely speaking, an ‘ego’ driven view) or a whole, an imperfect and emerging collective. This tracks a distinct evolutionary pattern in Sri Aurobindo’s works: interest, preference and partiality are a natural complement to desire – so long as the latter exists, the former will too. It is naturally expressed through the ‘right’ to vote one’s share, a freely expressed opinion, that is aggregated to arrive at a majority will. This is the *rajasic* ‘ordered conflict of interests’ Sri Aurobindo discusses as the natural consequence of democratic setups if the collective consciousness is as yet sufficiently purified.²⁰⁷ What follows then are the usual mechanics of compromise and accommodation of views to balance interests, and canvassing, lobbying to persuade one’s peers to join one’s camp. In its extreme forms, this yields to ‘politics’. The Governing Board, on its part, alluded to these dynamics in the Auroville collective: ‘The Board noted that a system based on competitive elections has

²⁰⁶ See, for example, Depuis-Déri, 2010; Krick, 2021. For a classic discussion on the problem of disagreement in democratic arrangements, see, Waldron, 1999.

²⁰⁷ Sri Aurobindo, CWSA, 1997, Vol. 25, 198. The debate on the justification, nature and limits of rights, in relationship to the public good, merits deeper examination in Auroville’s context to develop a shared moral language sensitive to its aspirations. Can residents’ ‘rights’ be enumerated and is it wise to do so? Are they justified by reference to autonomy and will, interest, virtue ethics and / or the spiritual essence residing in the soul? Are rights to be positively or negatively defined, and how do they relate to residents’ duties? How does this conceptualization reflect in Auroville’s current discourse, and what discrete or diffused interventions are needed to progressively transition to the ideal? Equally, navigating between right, duty and goal / consequentialist-based accounts of how collective decisions may be justified, each reflected in Mother and Sri Aurobindo’s thought and Auroville’s daily exchanges, is an important and exciting area for future research in conversation with the long-standing and layered literature on the subject. See, for example, Marmor, 1997.

only polarized, politicized and created divisions among the residents ...²⁰⁸ This is naturally far from Auroville's ideal, yet a natural and expected phenomenon in the evolution of democratic setups that the community is perhaps destined to pass through (though not linger too long in), one that Mother signalled in her message for Auroville:

All impulsions of rivalry, all struggle for precedence and domination must disappear and give way to a will for harmonious organisation, for clear-sighted and effective collaboration.²⁰⁹

We may read this remark in the backdrop of the movement Sri Aurobindo describes – roughly put, it proceeds from a uniform will in *tamasic* societies (where the individual will is subsumed within the collective) to an adversarial conflict of individual wills as the *rajasic* element emerges, moving slowly to accommodation, compromise and negotiation, and finally, in advanced stages, a unified will that is a free expression of the diversity of individual positions. The first step is a *tamasic* consensus, the middle step is a battle of individual and collective wills, the *rajaso-sattwic* stage, and the last is a spiritual one, the expression of the Divine will.

In his *Life Divine*, Sri Aurobindo lays out this account in some detail: the circle of interest, an expression of desire, expands progressively in the 'ascent of life' – it starts from the domination and expansion (the 'infra-rational' stage), the 'pseudo-democratic stage' of 'disguised oligarchies' with 'extreme divisions', and proceeds slowly to self-interested calculations converging with that of others (the basis of aggregative systems). This leads in time to increasing sympathy for and identification with others such that their interest forms part of one's own – this is an associative system of participation, not an adversarial or competitive one, based on mutual help, co-operation and later stages altruism, albeit still an 'extended selfishness', leading to impersonal and impartial assessments that voluntarily sacrifice one's own interest for the whole.²¹⁰ This is an evolved stage of being, particularly if achieved in the mass, yet incomplete. Sri Aurobindo paints the picture in *Savitri*:

Hearts could draw close through distance, voices near
That spoke upon the shore of alien seas.
There beat a throb of living interchange:
Being felt being even when afar
And consciousness replied to consciousness.
And yet the ultimate oneness was not there.
There was a separateness of soul from soul:
An inner wall of silence could be built,

²⁰⁸ 61st Meeting of the Governing Board, Auroville Foundation, 2023, 20. Ayer et. al., 2019, 28 make a similar, though more muted reference to a 'buddy network ... eroding trust in the working groups' and a 'systematic bias' in policy planning 'against development for growth in the residents.'

²⁰⁹ Mother, CWM, Vol. 12, 40-1.

²¹⁰ This is a rough caricature of a complex movement that requires deeper examination. There is a long-standing debate on the nature and place of motivations for social and political action, with a range of self-interest, reciprocity / fairness and altruism-based explanations, investigated across sectors (family, work, community etc.), nature of work (finance, care, administration etc.), form of communal identification (clan, family, neighbourhood etc.), proximity to the issues and traditions (secular and otherwise). This is an exciting area for applied philosophical and psychological research in Auroville to contribute its experience. See, for example, Rawls, 1999, 127; Fowler and Kam, 2007, 813-816; Mansbridge, 3-22, in Mansbridge (ed.), 1990; Hicks, 2005. This in turn traces a fundamental debate on the place of self-interest, rational choice and altruism in accounts of human nature, where Sri Aurobindo and Mother's evolutionary account has a complex answer, and method of practice, to investigate – if reflected at-scale in Auroville's lived experience, it can yield important results.

An armour of conscious might protect and shield;
The being could be closed in and solitary;
One could remain apart in self, alone.
Identity was not yet nor union's peace.
All was imperfect still, half-known, half-done.²¹¹

And finally, as the distant culmination comes the further expansion of individual interest desire till it merges with the Divine will – ‘the practice of association, of conscious joining and interchange are the seeds out of which flowers the principle of love.’ In proportion to how fast this movement occurs can the aspiration of an uncoerced, free consensus emerge. Sri Aurobindo goes on in *Savitri* to describe this decisive and final advance:

Each gave its powers to help its neighbours' parts,
But suffered no diminution by the gift;
Profiteers of a mystic interchange,
They grew by what they took and what they gave,
All others they felt as their own complements,
One in the might and joy of multitude.²¹²

Here, institutional forms discussed above in our proposal for a confederated setup can facilitate this forward movement, by pushing for greater interaction and interchange in smaller collectives that may hasten to bonds of association. But they cannot determine it, for it must ultimately come from a (difficult) inner change that shifts from ego-centred desire (that is adept at generating reasons in support) to a progressively fraternal one based on the greater good that may conflict with one's own material position:

At once the key of the problem is shifted from without to within, from the visible externalities of social and political adjustment to the spiritual life and truth which can alone provide its key. Not that the outer life has to be neglected; on the contrary the pursuit of the principle in one field or on one level, provided we do not limit or fix ourselves in it, helps its disclosure in other fields and upon other levels. Still if we have not the unity within, it is in vain that we shall try to enforce it from without by law and compulsion or by any assertion in outward forms.²¹³

This widening of one's view, an expansion of the self, will reflect in attempts to reconcile divergent views – ‘for and against’, ‘either / or’ – in a whole, as for example attempted in Annexure 5 to the Full Report of the 2015 Retreat. This task of consensus building requires a fraternal and informed public space – participatory forms that democratize each one's share in collective matters without either are dangerous, and likely to be an unwieldy or tense cacophony with ‘fatal’ inefficiencies. Institutional recalibration may help here:

First, our proposal for federated assemblies can, we hope, allow for this fraternity to emerge in smaller collectives, and also place matters for discussion before the assembly in which residents are more likely to be better informed.

²¹¹ Sri Aurobindo, CWSA, 1997, Vols. 33-34, 187.

²¹² Sri Aurobindo, CWSA, 1997, Vols. 33-34, 326.

²¹³ Sri Aurobindo, CWSA, 1997, Vol. 25, 632.

Second, our proposal for a representative Residents' Assembly can, one again hopes, allow for city-wide matters on which individual residents may not have sufficient information or inclination to effectively participate to be discussed amongst a smaller core of trustee-representatives whose wisdom is better suited to this task.

Third, the assemblies are unlikely to have sufficient information or expertise for a range of technical matters – for this, as we discuss below:

- i. It is necessary to institute procedural reform in the assemblies, managed by the Residents' Assembly Service, to allow for debates to be informed by previous studies, expert-opinion and facts (a function served in legislative assemblies usually by standing or select committees), a missing piece of the puzzle in Auroville today.
- ii. It is important to distinguish between legislative, policy setting and executive, technical work: for a legislative assembly, the Residents' Assembly or Zonal / sub-Zonal Assemblies, to enter into the latter task, as some suggested in our interviews, is neither practical nor wise.

b. Three Senses of Consensus

These institutional suggestions may assist thus in generating a governance framework more likely to result in consensus. However, on the pathway to that elevated stage, it may be useful to keep three meanings of the word 'consensus' in mind. The first is consensus as universal agreement, with each reflecting one aspect of the Divine Will merging in a harmonious whole, the utopian ideal; the second more practical one is consensus as accepting decisions one does not agree with in voluntary deference to the collective; and the third is consensus is a passive acquiescence or involuntary submission to the common decision.

The first is ideal, the second is possible, the third is probable. The middle sense is premised on some important conditions that make this sacrifice or readiness to go along even if one disagrees plausible. Taylor's astute commentary on what makes democratic consensus possible is helpful here:

The conditions for a genuine democratic decision can't be defined in abstraction from self-understanding. They include (a) that the people concerned understand themselves as belonging to a community that shares some common purposes and recognizes its member as sharing in these purposes; (b) that the various groups, types, and classes of citizens have been given a genuine hearing and were able to have an impact on the debate ...²¹⁴

In a society of mutually disinterested agents, intent only on their own life plans, this second model of consensus is unlikely, for 'how could there be a widespread acceptance to abide by the rules and outcomes of a democratic decision among people who have no bond whatever?'²¹⁵

Things can be very different in a community [as opposed to an aggregation of mutually disinterested agents]. Here the sense that you have been given a hearing

²¹⁴ Taylor, 1985, Vol. 2, 276.

²¹⁵ Taylor, 1985, Vol. 2, 276.

depends not just on the particular interchange, but on the state of the whole relationship. People can have a sense that they are heard because they know themselves to be valued in a certain way, even when some particular demands are not met. Their sense of being heard will also depend on the relation of their goal to common purposes, and to the goals of other groups with whom they feel solidarity in the light of these purposes. So a refusal of one of their proposals may be consistent with their having been heard.²¹⁶

The self-defined *perception* of each resident that they belong to the whole is the trigger, that much be generated. In other words, it requires a fraternal association where one's claims and liberties, even if unmet, are voluntarily given up because of a sense of solidarity. As we discussed above, this important consideration is what led Sri Aurobindo to place fraternity, the ignored third of the famous formula, as the *base* of the pyramid of an effective governance model, and to Mother's constant and repeated urge for unity amongst those involved in the early planning:

What would really please me is if they [Roger and Paolo] could agree with each other and present me with a project of the two together.²¹⁷

(Directly to Nava and Udar:) You and you, you must agree. You are here for that. You have come to this place at this time for that. We must give to the world the example of what must be, not petty egoistic movements, but an aspiration towards the manifestation of Truth. Voilà.²¹⁸

[Message to Roger, probably for the CAA] You must all agree. That is the only way to do good work.²¹⁹

We speak of Union and say we are working for it. But the spirit of quarrelling is in our midst. Shall we not conquer the insincerity? I am here to ask you to do it. And the best way is to join in the service of the Divine.²²⁰

Truly, I can't say what to do. I am no architect, not an expert. Each one is sticking to one's own point of view. (She shakes her hands). What is the solution? S.S.: Piero is the most capable person for the construction. He is necessary for the work. I can try to persuade him, Mother. And if he is not persuaded? S.S.: Then I don't know. Try to find out a meeting point, a common base for the work to be done.²²¹

The true spirit of Auroville is Collaboration and must be more and more so ... True collaboration paves the way to divinity. Blessings.²²²

Yes, they talk of human unity and act like this. It is grotesque. [People outside are intelligent, and they laugh at us.] Yes they laugh ... I will tell you that we are preaching unity – unity of humanity – and we are all quarrelling – horrible quarrels,

²¹⁶ Taylor, 1985, Vol. 2, 277.

²¹⁷ Guigan, 2018, Vol. 2, 43.

²¹⁸ Guigan, 2018, Vol. 2, 348.

²¹⁹ Guigan, 2018, Vol. 1, 99.

²²⁰ Guigan, 2018, Vol. 2, 337.

²²¹ Guigan, 2018, Vol. 2, 416.

²²² Guigan, 2018, Vol. 2, 415.

resentments and all sorts of urgings that we condemn in the others. We are giving a nice example, and people laugh! Voilà.²²³

For each problem there is a solution that can give satisfaction to everybody; but for finding this ideal solution each one must want it instead of meeting the others with the will to enforce one's own preference. Enlarge your consciousness and aspire for the satisfaction of all. ... You see only your side of the question, but if you want to widen your consciousness it would be better to look from all sides impartially, later you will discover that this attitude has great advantages.²²⁴

This is also what Taylor emphasizes as the enabling condition for *common* action in cases of disagreement. The realism attached to interest-based voting considers the community as an aggregation of mutually disinterested agents, but 'can't take account of the fact that people's views can be altered by the interchange, that consensus sometimes emerges, that citizens frequently understand themselves as part of a community and don't vote out of individual interest alone ... in particular, it can't account for the degree to which a political society functions as a community.'²²⁵ The weakening of these bonds of friendship, sympathy and more leads to fragmentation, that makes the second kind of consensus more difficult to achieve. The atrophy of collective bonds, which can be meaningfully developed only at federated scales in our assessment of Auroville currently, makes certain 'issues harder to address those requiring a democratic consensus around measures that will also involve some sacrifice and difficulty'. Needless to say, these decisions have been and will be aplenty as Auroville grows. It is here that Sri Aurobindo's articulation of 'group-souls' as moulds to generate corporate belonging is important.

A functional model of democracy does not mean that one's views will always prevail – to the contrary, it is about going along *when* contrary views prevail, born out of an ethic of civic care, a voluntary submission to one's collective as long as the process is fair and reasonable.²²⁶ Democracy's discontent is getting things done in plural societies like Auroville, respecting and adopting reasonable views one disagrees with, if developed after due deliberation in the community with expert or illumined guidance. This is what Mother emphasized as the 'collective discipline' required for stable organization – for that prescription to be meaningful, a readiness to go along with the collective decision even if one has reservations is necessary. Extreme cases aside, if this sentiment does not persist in the community, fragmentation risks throwing a spanner in the works. The point, in other words, is not to 'agree *to* disagree' but to 'agree *despite* disagreement.'

The lowest common denominator in generating 'consensus' is that of aggregative interest-based voting, where the majority vote prevails with dissents recorded, a practice used reluctantly but regularly in the Residents' Assembly; the middle denominator is agreement to go along with a *common* plan despite objections, the second form of consensus; the highest

²²³ Guigan, 2018, Vol. 2, 345.

²²⁴ Guigan, 2018, Vol. 2, 275.

²²⁵ Taylor, 1985, Vol. 2, 276.

²²⁶ See, for discussions, Miller, 2012; Christiano, 2015; Levy, 2021. For an interesting discussion, relevant to Auroville's practice, on the transformation of original preferences in dialogue rather than simply an aggregation, see, Hendriks, 2010.

denominator, which Mother suggests in the quotations above, is true agreement and consensus born of unity. Professor Joshi, an exemplar of the idealism of the third stage, articulates the final movement, defining the ‘self’ in democratic self-governance not as the ego, but the inner being that can find this deeper resolution, a fraternal union of all:

The true meaning of Self-Governance ... Auroville was envisioned for people who aspire to attain a higher state of consciousness than the present state of humanity, so that the will of the individual may align more and more with the direct will of the Divine in action. The path towards this alignment could only be found through oneself, through one’s own spiritual quest and inner seeking. For aligning with the will of the Divine, it is necessary to forgo one’s personal will which is always encapsulated within the ego. The journey from letting go of the personal will and aligning with the Divine will requires immense amount of study, research and spiritual practice ... So, true self-governance is that which allows the citizens of the land to truly realize the Divine within themselves. With this merging of the personal with the Divine, a self-governance model will emerge embedded in this inner discovery. The Mother has and continues to create circumstances so apt, that achieving this, inwardly and outwardly, can become truly effortless. When the lines between personal will and Divine will blur, and an inner joy and radiance becomes the norm, true self-governance can and will be realized in Auroville.²²⁷

Yet, in the long, evolutionary path to that ‘blurring’, disagreements in the second sense can *still* be respectful and productive, cementing ties of solidarity – for if one agrees to a common plan despite reservations, it demonstrates a willingness to be part of the collective. But *persistent* disagreements that refuse to voluntarily align – a ‘competitive individualism’, with the aspiration for consensus translating into a conflict of interests and ‘veto’ absent agreement – are troublesome.²²⁸ For the social contract to work, residents’ deliberations must be ready to ‘forgo’ policies which ‘would be in one’s personal interest alone, or in the common interest of a group smaller than the whole’ – as Barry incisively notes, this sharp edge is the test of ‘good faith’, with the ‘bluff’ of unity being called each time this does not obtain.²²⁹ Put otherwise, creative solutions that satisfy each member, on which the first kind of consensus is possible, are naturally preferable; yet if that is not immediately possible, the idea of *public* interest or a *collective* good, as more than an open or disguised negotiation of private interests each vying for satisfaction, requires voluntary sacrifice: ‘They grew by what they took and what they gave / All others they felt as their own complements.’²³⁰

Indeed, there may be a category of *fundamental* disagreements, where such voluntary submission is contrary to conscience or principle, but those will in a well-functioning collective bound by a set of common values (in this case, the Charter and Mother and Sri Aurobindo’s ideals), be, one hopes, relatively minor. They will require special treatment, as in the case of the disagreement over the Galaxy discussed in Part II.B. Short of that, if the process of decision-making is reasonable and informed, with an open discussion (in practice) that allows for residents to have an opportunity to present their views, convince others and be convinced in

²²⁷ Auroville Tomorrow, 2021, 9.

²²⁸ Sri Aurobindo, CWSA, 1997, Vol. 25, 569.

²²⁹ Barry, 122-3, in Quinton (ed.), 1967.

²³⁰ Sri Aurobindo, CWSA, 1997, Vols. 33-34, 326.

turn (which is a question of how one approaches the assembly), such that participants feel their voices have been heard and given due weight, *then* decisions are likely to be accepted despite dissent. Disagreement can in this case generate respect for plurality, yet lead to common action.

Developing this sense of a common ‘us’, a collective bound not just by a practical convergence of enlightened self-interest over particular issues but solidarity born of a common purpose, is as critical as it is difficult to develop. Yet that is where the principle of fraternity manifests in action, at the level of daily works – the finalization of a Detailed Development Plan being one practical litmus test to measure this sentiment. The centripetal force of the ‘us’ – the horizontal *communitas* – must, in the end, overcome the centrifugal pulling of each in her own direction. The issue boils down, as indeed it always does, to inner work, easily stated in studies of the kind we are currently engaged in, yet notoriously difficult to practice:

But whether to form or to preserve the growth of the sentiment, the psychological factor is indispensable; without it there can be no secure and lasting union. Its absence, the failure to create such a sentiment or to make it sufficiently living, natural, forcible has been the cause of precariousness... But the experience of the past shows that this mere necessity of convenience is in the end not strong enough to resist the pressure of unfavourable circumstances and the reassertion of old or the effective growth of new centrifugal forces.²³¹

v. *Bicameralism*

In attempting to achieve this common action, Auroville may consider a bicameral setup for the Residents’ and Zonal / sub-Zonal Assemblies: in this proposal, each assembly would have two ‘chambers’: a ‘Council of Residents’ and a ‘Council of the Wise’. The nomenclature is secondary, but the principle of bicameralism, in our view, is a practical manifestation of the principle of illumined hierarchies that may serve the community well. The Council of Residents would be direct (in Zonal / sub-zonal Assemblies) or representative (in the Residents’ Assembly); the Council of the Wise would be selected independently by triply-constituted Steering Group we recommend below (other design options may equally be considered, if this proposal is considered viable). Similar ideas with the ‘Council of Sages’ etc. – though made in the context of executive or regulatory bodies, not legislative ones – have been mooted in the past, though without much traction. The idea behind this second chamber is simple, though we are aware likely to be met with hesitance:

- i. The second chamber is both *demos* constraining and *demos* enabling. It constrains the Council of Residents by ensuring that the popular will that emerges from that house is consistent with the values of the Charter, providing where necessary, a counter-weight to the stresses of popular sentiment of the day. It enables by providing wise counsel and guidance on policy matters.
- ii. In this, it acts as a bulwark against any partisanship that may emerge in the working of the democratic principle, and allows for independent feedback, leading to a balanced decision-making process.

²³¹ Sri Aurobindo, CWSA, 1997, Vol. 25, 572.

- iii. As we outline the institutional template in Section D below, the members of the Council of Wise will be selected zonally / sub-zonally – so, for the Residents’ Assembly, each zone will have a member on the Council, and for the Zonal Assemblies, each sub-zone will have a member on the Council. This can facilitate for strengthening zonal communities along organized lines, an important need in Auroville’s current governance practices for the reasons discussed above.
- iv. The aristocratic origins of bicameralism – with status-based selections – can be replaced by a true aristocracy of the wise, giving reasons for a compelling experiment in governance structures.²³²

As we discussed above, Mother was quite emphatically not a votary of unqualified democracy for Auroville, much as she wanted an equal participation of all. In a conversation dated April 10, 1968 she noted:

If there is no representative of the supreme Consciousness (which can happen, of course), if there isn’t any, we could perhaps (this would be worth trying) replace him with the government by a small number – we would have to choose between four and eight, something like that: four, seven or eight – a small number having an intuitive intelligence. ‘Intuitive’ is more important than ‘intelligence’: they should have an intuition that manifests intellectually. (From a practical standpoint it would have some drawbacks, but it might be nearer the truth than the lowest rung: socialism or communism ... The other one too is now giving proof of its failure, the government of ... what can we call it? Democracy?²³³

Our proposal for trustee-representatives is animated by this sentiment; it can also manifest in a bicameral assembly, which would not ‘replace’ the *demos* as Mother suggested, but at least complement it. Our understanding it that the likelihood of the community agreeing to a small number – between four to eight – to replace is low; yet, one may begin that experiment with a bicameral setup. Naturally, there are epistemic and political concerns: how are we to know who has an ‘intuitive’ vision of things? What if this select group abuses its power, leading to the problem of enlightened despotism? We have addressed the second issue above; on the first, it is a knotty question, to which one naturally cannot give a water-tight answer. Intuitive intelligence manifests in subtle, various and non-quantifiable ways. We may, however, note that Mother’s suggestion is for the *best available* residents to be selected to these positions, even if there is no representative of the highest consciousness. Indeed, if Auroville is – as its *raison d’être* – to develop conscious beings, the unavailability of such residents, *if* that is the case (as some conversants noted), would be a somewhat disconcerting fact that would merit introspection. At any rate, this setup – balancing the direct democratic impulse with that of an intuitive government of the few – is worth the attempt, given Mother’s express wish for an arrangement along these lines.

vi. Procedural Forms for Informed Deliberation

The effective and ordered functioning of a deliberative assembly requires procedural rules – to the best of our understanding, the Residents’ Assembly currently does not have rules of order that guide debate on the floor of the Assembly. Suggestions along these lines have been made

²³² We do not enter the details of the debate on bicameralism. For an overview, *see*, Fisk, 2020; Uhr, 2009.

²³³ Guigan, 2018, Vol. 1, 276.

previously by the Governing Board and are now pressing. While there may be some reluctance to such ‘rules’, they do not limit, but enable, quality deliberation. To take an example, in the August 2022 General Meeting on the Crown, for which a transcript is publicly available, some procedural concerns arise:

- i. The details of attendance are not precisely recorded.
- ii. At various points, effective debate is hamstrung by missing information / factual details which were not immediately available to the participants.
- iii. Previous studies / discussions on issues debated at that meeting – reviewed in Part III.A – that could have clarified points and informed the debate did not seem to have been tabled. The absence of members with the relevant information / knowledge to speak on certain issues resulted in a sub-optimal debate.
- iv. Agenda items, prior compilations / documents of relevance, circulated questions on which the relevant working groups may have prepared responses in advance, to allow for an effective debate, seem to be lacking.
- v. Absence of tabled motions / proposals, which renders it difficult for participants to effectively prepare.
- vi. Unclear definition of decision-making processes, formats and timelines; binding nature of decisions.
- vii. Formalization, publication and dissemination of agreed-upon motions / Residents’ Assembly Decisions.
- viii. Process for review / amendment of decisions.

Procedural rules for these matters will assist in healthy debate, particularly as population numbers and the complexity of matters to be in the discussed in the Assembly grow. These rules need not limit or constrain the freedom of members to intervene, but rather, channelize participation. There is a substantial literature on deliberative rules for legislative bodies, which the Residents’ Assembly Service may consider for an appropriate design for Auroville.²³⁴ Professor Joshi, for example, suggested the need for structuring debate along these lines:

It is not a matter of calling a meeting suddenly and saying what is your view, what is your view, what is your view ... and suddenly somebody airing one opinion, another, another opinion ... This is in any case not the right thing for Auroville to do, this is not the way in which a meeting should be conducted.

²³⁴ See, Müller and Sieberer, 2014; Martin et. al., 2014; Carey, 2009. One classic formulation is in Robert’s Rules of Order, which is not an apt model for Auroville, but may serve as a useful template. Robert, 1996. On organization of committees to allow for informed debate, see, Martin, 2014.

The cultivation of a silent atmosphere that allows for absorption and an influence of the Divine's presence is key. For this, an ordered procedure may help generate a concentrated, healthy and efficient dialogue. Naturally, electoral rules are unsuited for Auroville, yet a range of other deliberative rules, with appropriate amendments to the 2007 mandate of the Residents' Assembly Service, will be helpful.²³⁵ These include, *inter alia*:

- i. Attendance records; verification processes where necessary; entry of observers / non-residents (newcomers, guests, visitors etc.)
- ii. Transcription / minuting services.
- iii. Agenda times circulated in advance with preparatory documents, with tabled proposal for action; format / processes for tabling.
- iv. Regularity / scheduling of the Assembly.
- v. Clarifying the order of business.
- vi. Speaking formats and orders, with space for open remarks; conventions, powers for effective moderation by the designated Chair.
- vii. Format for questioning; process for prior / circulated questions; responses by Working Groups; introduction of new matters, comments / remarks by members.
- viii. Principles / conventions of debate; including 'stop procedures' for timely decision-making.
- ix. Institution of committees / boards for expert comments / reports on tabled motions, for study and reflection.

vii. Legislative and Executive Domains

Auroville's governance scheme, as distributed between the Residents' Assembly, Working Groups and community initiatives, currently does not effectively distinguish between legislative and executive domains. The institutional structure is at times confusing – the Residents' Assembly is often a forum for discussing operational or executive matters, while the Working Groups are tasked with policy development.²³⁶ Equally, as we consider in Section C below, Working Groups are selected by a combination of sector-appointed 'experts' and community-appointed 'members', a part-popular or participatory appointment that one would usually associate with legislative, not executive, bodies.²³⁷ Equally, the executive mandate of the Working Groups – to implement policies agreed upon by the Residents' Assembly – is unclear, leading to further negotiation or at times, a refusal by the community to act on policies in place, thus recreating an unstructured, local debate that would in the ideal be focussed in the legislative fora of the Assembly where informed and inclusive deliberation can lead to a final policy decision. A clarification of the legislative and executive domains thus appears necessary

²³⁵ Mandate of the Residents' Assembly Service, 2007.

²³⁶ The Governing Board alludes to this. Minutes of 57th Meeting of Governing Board, Auroville Foundation, 2021, 1.

²³⁷ For a description of Working Groups, *see*, Clarence-Smith, 2019, 129-131.

for a distribution of governance labour. There is a long-standing and vigorous literature on the subject, which is beyond our scope – we point briefly to some salient organizational features that may be useful to inform the governance conversation in Auroville.²³⁸

There is a porous boundary between legislative and executive functions, yet both operate in distinct domains. The legislative function – whether through a democratic body, or an intuitive few – concerns norm-setting or policy, a laying down of the primary principles that may regulate the activity of the collective in written codes, the Residents’ Assembly Decisions. The executive function – ideally through an expert-constituted, not popular body – concerns the implementation and enforcement of the policy, including interstitial norm setting (‘delegated legislation’).²³⁹ The executive is not only a ‘delegate’ of the legislative arm, but both act in independent domains and mutually check each other: the legislative body keeps the executive in check, to ensure that it enforces policy and does not exceed it, whilst the executive implements and enforces policy equally, including on members of the legislative arm, and informs the legislative agenda through its expert input. This distinction between the legislative and executive domains is necessary not only for practical reasons, but also moral ones: conflating both powers in a single body – to legislate and execute / enforce – is an unwise choice, likely to lead to incoherence, ineffectiveness or selective application. As one resident perceptively noted:

It has always been difficult to organize Auroville’s internal affairs, but since a few years the situation has started to seriously go astray after major working groups began to modify their policies without ratifying the modifications through the Residents’ Assembly according to the existing procedures, or refused to execute a valid and legitimate decision taken by the Residents’ Assembly.

One of the recurrent mistakes we make is to mix the legislative authority and responsibility with those belonging to the executive. The legislative and the executive power or authority are supposed to be the two pillars of any organizational system. There is a body which envisions and decides how society will be organized, and another body which executes and implements this vision and decision. The legislative responsibility and role is naturally the role of the Residents’ Assembly. The executive responsibility and role is obviously the role of the working groups. The legislative and executive authority cannot and should never be in the same hands, whether it is the working groups or the Residents’ Assembly. For that would result in absolutism, and such a political system is the complete opposite of what a society like Auroville needs.²⁴⁰

This division of labour – common to modern systems, and with good reason – is incipient in Auroville. The small numbers in early years allowed for a porous mixing of the two functions, with committees and groups performing a dual function. Since 2010, the policy-setting function of the Residents’ Assembly has emerged slowly (for example, the 2016 FAMC RAD, 2017

²³⁸ See, in general, Schugart, 2009; Taylor-Robinson and Escobar-Lemmon, 2009; Metzger, 2020; Carey, 2009; Cox, 2009; Rhodes, 2009; Page, 2009. Auroville’s governance frame need not, and in many cases, should not trace the classic boundaries discussed in the literature, yet the essential distinction is useful.

²³⁹ See, Wade and Forsyth, 2009, 731-3.

²⁴⁰ Auroville Today, June-July, 2014, 32.

TDC-TOR RAD etc), though still with substantial overlaps with the Working Groups, who are also engaged in that enterprise (for example, the Housing Policy, 2011, Code of Conduct, 2017), subject at times to the nominal ratification or control of the Residents' Assembly. As the system evolves, it is useful to define and distribute these functions clearly and align appointment practices accordingly, to select members to each domain consonant with the function that they perform. As we discuss in the next section, the Working Groups, as executive bodies, will then require domain experts, not popular selection, to effectively perform their function, while the Residents' (and Zonal / sub-Zonal Assemblies) will have direct or representative participation to allow for the effective participation of all in norm, policy and agenda setting.

The 2014 Participatory Working Group Selection Guidelines, amended in April 2022, which operate on a fairly cumbersome and time-consuming process – of nominations, with appointments by 'Selection Teams' chosen at random, on the basis of resumes, motivation letters, interviews and anonymous feedback, with undefined, internal processes adopted by each team and a 'lottocracy' (the 'hat' rule) – will then require calibration.²⁴¹ This process, its merits and inclusivity aside, does not bear a rational nexus to the executive mandate of Working Groups, which require an assessment of expertise and naturally, integrity, that may most efficiently be made by those qualified to measure that expertise. The means is unsuited to the desired end. An executive body is best appointed on the basis of an evaluation of qualifications, prior experience, technical criterion for the nature of the work etc., not popular, participatory methods.

The important and necessary democratic, participatory impulse is rather channelized through the legislative body, the Residents' and Zonal Assemblies, where open dialogue and debate is best had. Equally, each Working Group must – as we discuss in the next section – have robust, structured and time-sensitive participation or consultation with the relevant communities (organized zonally / sub-zonally) in the development and implementation of plans in accordance with the policy adopted by the Assemblies. In this, the legislative bodies may, and must, render effective checks and ensure accountability on the power of the executive, the Working Groups – as we suggest in our institutional template, the Assemblies may select one member on popular, participatory criterion, if deemed necessary, for each Working Group, as a channel for accountability and feedback. In sum, a fuller discussion of the legislative-executive mechanics would be necessary to detail-out the functions, modes of operation and linkages of the two domains, yet the essential distinction is important for a workable and coherent governance model.

*

²⁴¹ Participatory Working Groups Selection Guidelines, 2022, 10-5.

C. WORKING GROUPS REFORM

We have outlined the history and emergence of Working Groups in Auroville in Section A above – the organizational structure emerged piecemeal, with a push post the AVF Act, 1988 Act, articulating itself largely in response to emergent problems. In the evolutionary scheme of things, this ‘organic’ development was useful and natural as a way for the community to experiment with its organization, offering space and diversity for a range of self-start initiatives in a culture of loosely networked small groups. Ciconesi and Ciconesi’s short remarks beautifully sum up the issue:

Over the years, Auroville has attracted, and continues to attract, people from all over the world. Some leave in the face of difficulties of pioneering something new, others because of the seemingly chaotic system of governance and decision-making with no hierarchical structure. Too much idealism can wear off, as can day-to-day practical difficulties of different cultures living together, where nothing belongs to anybody in particular but to the collective as a whole. Some stay on, never giving up, believing this to be their *karmabhoomi*, believing in the impossible, giving it all they have and in the process moulding themselves, defeating inherent inertia, jumping over their own shadows, trying, experimenting with renewed vigour, sometimes with wisdom, other times with naivety. And so ‘The City’ builds itself slowly but surely.²⁴²

The plasticity, freedom and space are critical to maintain; yet, the rationalization process outlined by Sri Aurobindo, addressed above as the next step necessary to develop an ‘intelligent’ and ‘self-conscious’ systematisation is pressing, to move forward without delay and dissipation. It is this dual movement – of centralized authority and liberality – that Mother described when asked, ‘what will the political organization of Auroville be like?’

There will be no politics. The town will be directed by a Municipal Council, a committee of technicians, headed (in order to avoid any arbitrariness) by two people in authority who are no longer imprisoned by the mind, who possess true knowledge. Any regulations will be as liberal as possible and very flexible. Rules should arise according to the requirements. Plasticity and swiftness are needed in order to keep up with world-movements, so as not to fall behind the universal progress.²⁴³

Several opportunities – to ‘keep up with world-movements, so as not to fall behind’ – have already been missed in the past two decades, with chronic governance concerns. Today, particularly with the imperative of a phase shift to city-building, a recalibration of the Working Groups will be useful to meet the demands of that complex task in a peaceful, productive and efficient manner. Our sectoral overview in Part III highlighted six concerns: (i) participatory inflation, (ii) a conflation of executive and legislative mandates, (iii) untenable selection mechanisms for Working Groups, (iv) weak executive powers for implementation and enforcement, (v) accountability concerns, with the absence of review mechanisms and (vi) the aspiration for consensus translating to a veto.

Accordingly, in this part, we consider (i) the mandates, powers and inter-sectoral coordination of Working Groups, including the need for a governance dashboard and data management

²⁴² Ciconesi and Ciconesi, 2012.

²⁴³ Guigan, 2018, Vol. 1, 163.

system, for transparent and evidence-led executive processes. (ii) selection and accountability processes, (iii) enforcement and dispute resolution and (iv) participatory mechanics in relation to implementation. As before, our reflections and suggestions here are brief and will require further detailing-out if considered viable.

i. Working Group Mandates, Powers and Inter-Sectoral Linkages

The mandates of the Working Groups, particularly the FAMC, TDC, Auroville Council and Working Committee, are fairly vast and generally worded. The operation of these groups over the years appears to be variable, with an uneven understanding amongst members (past and present) whom we interviewed as to the nature and scope of their responsibilities. This was in relation to:

- i. The scope of authority / work, translation of the broadly worded mandates into specified heads of action.
- ii. Internal organization, definition of streams of work, authority or collaboration structures, drafting of work plans, performance benchmarks, timelines and metrics for assessment, allocation of responsibilities vis-à-vis defined qualifications / competence, operational processes, meeting formats etc.
- iii. External organization, in relation to overlaps with other Working Groups, zonal bodies and community initiatives at large.
- iv. Policy-making authority / reporting formats / linkages and accountability mechanisms vis-à-vis the Residents' Assembly and the Governing Board.
- v. Enforcement and dispute resolution mechanisms, both *inter se* and externally.
- vi. Data management, archival and handover processes for institutional continuity.

These concerns are reflected in the 57th and 61st minutes of the Governing Board, the 2015 Retreat, 2014 IDPP and the 2019 study by Ayer et. al. For example, Ayer summarizes:

Essentially the five main working groups (Entry Board, Working Committee, FAMC, TDC and the Auroville Council) have to come together and set up a policy planning body which looks at all existing mandates and regulations to bring convergence of policies, and this needs to be backed up with a reliable data management system for an accountable administration and an informed decisionmaking process. The data would give the quantitative goals while the programmes give the direction. These two must work together in a way that permits adaptation to new information, knowledge and changing circumstances. This is why it would be counterproductive to have policies that are too long term or overarching, as they become an impediment to the very thing they were set up to enable.²⁴⁴

²⁴⁴ Auroville Today, May, 2021.

The chief concern voiced in interviews with members of the Working Groups was the lack of clarity and uncertainty on the scope and nature of the executive powers of Working Groups, particularly in relation to undefined participatory processes and constant negotiation, and the resource capacity / competence of members of those groups to conduct the tasks identified in their mandates – indeed, many members we interviewed were unaware of the precise mandate codified in relation to their groups. As a result, the identification of authority to implement / conduct works and conversely, accountability is a serious concern.

Over the years, the gap between the proposals / plans / reports produced across sectors – reviewed in Part III – and their implementation is stark, often with a repeated cycling of proposals without reference to prior work done in the area. In general, to the best of our understanding, Working Groups over the years have had a variable practice of preparing annual and term Work Plans, with defined outcomes, timelines, resource mobilization plans, performance benchmarks etc., though the mandates in several cases (as in the FAMC, TDC) codify this requirement. In general, the hierarchy of plans required under the Masterplan to conduct development works have not yet been prepared.

From interviews, it appeared that Working Groups are under serious human resource constraints (administrative, clerical, technical support teams), with weakly defined processes for daily functioning across planning, implementation and internal accountability. Concerns with professionalism and competence were also routinely raised, particularly in relation to internal capacity constraints in technical matters that fall within the domain of the Working Group. On being asked whether and how the mandates were being translated into plans for implementation, most members noted that no such processes were in place, often with the authority and responsibility to conduct those works being identified elsewhere. The daily functioning in many cases seemed to be devoted to ‘fire-fighting’.²⁴⁵

In general, the mandates of the ‘major’ Working Groups – the FAMC, TDC, Working Committee and Auroville Council – are often somewhat vague or vast. The 2016 FAMC Mandate lists 23 ‘responsibilities’, to formulate ‘financial and economic policies’, approve budgets, manage community assets, including land and housing, oversee functioning of all trusts and units, oversee land stewardship, conduct internal audits, oversee the Housing Board and Service, Budget Coordination Committee, Unity Fund etc. In addition, it is to ‘meet’ with the Residents’ Assembly on a quarterly basis, with Annual Work Plans against which reviews are to be conducted. The TDC mandate (under the 2019 Standing Order, the relationship of which to the 2017 Residents’ Assembly TOR is unclear) comprises thirteen ‘functional areas’ (town planning, urban design to social and economic infrastructure development, the latter of which seem to overlap substantially with the stated FAMC mandate). The mandate of the Auroville Council approved in 2004 requires it to ‘coordinate a short term plan and budget, in collaboration with the APDC, SAIIER, ABC and the FAMC, and other working groups to be presented to the Residents’ Assembly for yearly ratification’, develop quasi-judicial fora for dispute resolution, ‘deal with emerging issues outside the purview of other Working Groups’, ‘encourage the generation of programs and policies’, ensure accountability amongst Working

²⁴⁵ Kalra, 2014, 93-4; Clarence-Smith, 2019, 123.

Groups and enforce Residents' Assembly Decisions. The 2004 mandate of the Working Committee, the only statutorily identified Working Groups, is primarily for outward facing activities (liaison with the Governing Board and International Advisory Council and government entities), but with otherwise vague responsibility, with substantial overlaps with other groups, to recommend visas (also the mandate of the Residents' Service), to recommend land purchases (also the mandate of the FAMC and Land Board), coordinate relations with local villages (also the mandate of the Auroville Village Action Group and the TDC), recommend appointment of unit executives (also the mandate of the FAMC), finalize accounts and balance sheets (also the mandate of the FAMC and Accounts Coordination Group), facilitate police liaison (also the mandate of the Security Task Force, as of 2022, the STTF reporting directly to the Secretary of the Foundation). For other Working Groups, the ambiguity in organizational structuring is similarly a concern, detailing sectorally in Part III: SAIER's mandate vis-à-vis Auroville and Outreach schools, pedagogical research and research in general is unclear; the Land Board has seen eight changes or amendments to its structure between 2005-2020; the Housing Service's response to the TDC / Ayer et. al.'s 2019 work indicating that the development of housing is outside its authority; the mandates, powers and internal structuring of the four Zonal Groups are unclear; the ABC and ABS seem to have had a variable functioning and, to the best of our understanding, are currently non-operational, with lack of clarity on the body tasked with commercial sector development; the TDC's relationship to sectoral / zonal bodies is undefined in the 2019 Standing Order, with the 2017 Residents' Assembly ratified TOR indicating that it is consult 'WC [whose mandate does not extend to city-planning], AVC [vaguely defined mandate for inter-sectoral coordination], FAMC [whose mandate substantially overlaps with the TDC's mandate for 'socio-economic planning'], BCC [a sub-group of the FAMC, such that the double track consultation is unclear], ABS [not operational], AVAG [the link with the proposed TDC Regional Coordinator in 2013 is not defined in 2017], Housing Board [again, a sub-group of the FAMC, and as per the 2021 mandate, with a TDC appointed representative], SAIER, Land Board [again, a sub-group of the FAMC] and individuals involved in planning and development (IZG / Industrial Zone / art and cultural / architects) [unclear why the other Zonal Groups for the Cultural and Residential Zone as not included; also unclear whether the Industrial Zone Group exists, or if the Board of Architects is operational].'

The lack of clarity in the organizational structure is exhibited, for example, in the 2015 Retreat and 2019 TDC / Ayer et. al. Development Priorities Study – while a range of priority actions were identified with wide-ranging consultation, neither identified a body empowered and accountable to implement, or if it did, it appears that no follow-up actions were taken by those bodies. The resistance centralization of executive powers in the community and the piecemeal emergence of the organizational structure over time perhaps explain these matters. Yet, the inefficiencies of the process now apparent require an organizational audit to define the structure, process and review mechanisms.

A detailed assessment is beyond our scope here, but the following issues require consideration in this exercise:

i. *Executive powers:*

- a. *Defined powers:* In line with the principle of ‘illuminated hierarchies’, and more generally, of effective centralization, the executive powers of Working Groups over implementation requires clear and unambiguous articulation. This must be supported by a strong, yet structured, participatory process and accountability mechanisms, discussed above.
- b. *Legislative-Executive Distinction:* As we discussed above, a clear distinction between legislative and executive domains is necessary, such that implementation works / plans are not necessarily tabled before the Residents’ Assembly.
- c. *Policy Input:* the input of Working Groups to the Residents’ or Zonal Assemblies for policy matters requires a clear process, for which we suggest the selection of one member of each Working Group by the Assemblies on democratic principles.
- d. *Enforcement and dispute resolution:* executive power to implement requires a clear identification of enforcement mechanisms in instances where voluntary compliance is not forthcoming. As we discussed below, non-coercive and voluntary consensus, with a fraternal ethic and strong community engagement, is central to Auroville’s aspirations; yet, in defined instances where implementation of policy is rejected, delayed or subject to persistent disagreement, defined dispute resolution and enforcement mechanisms are necessary and as yet, weakly defined in Auroville.

ii. *Mandate restructure:*

- a. *Definition:* the mandates of various Working Groups – with the short discussion above as an example – require precise definition, so as to remove avoidable uncertainties / ‘jurisdictional’ overlaps.²⁴⁶
- b. *Manageable:* several mandates, particularly for the FAMC, TDC, Auroville Council and Working Committee, are fairly heavy, with a range of tasks unlikely to be effectively managed by a single group. In many cases, the defined tasks, particularly in relation to the FAMC and TDC, require different qualifications / competences that are unlikely to be found in a single individual / may be better served by smaller, more precise mandates in different bodies.

²⁴⁶ This work was partially attempted in 2018 by the Working Committee and Auroville Council. It requires a more thorough review and rehaul. *See*, News and Notes, No. 762, 5.

- c. *Overlaps*: overlaps between mandates is inevitable, and a clear definition of inter-sectoral linkages requires definition, for joint meetings etc.

iii. *Internal structuring*:

- a. *Competence / qualifications*: identification of competences required for each Working Group, with defined qualifications as against which selection is made by an expert-led panel, discussed below, rather than popular vote.
- b. *Internal structure*: Working Groups currently have weak internal structuring in terms of defined work streams, departments etc., which leads to inefficiencies and accountability concerns. A clear internal division, with personnel and resource requirements, will be helpful. Alongside, the identification of a Chairperson for each Working Group, whether selected internally by members or selected / appointed as such is necessary for effective coordination and accountability.
- c. *Community facing and technical streams*: there is, in general and in particular for the TDC and FAMC, a necessity for a distinction between community facing / interface and technical streams, proposed in the TDC-TOR 2017 but currently not in place. The ‘participatory’ and ‘representative’ distinction is useful not in relation to selection processes, as is currently the case, but operation.
- d. *Capacity building and Training*: internal capacity in Auroville in various professional and technical domains is limited, for which phased capacity building programs (tied in, in the medium-term to the research infrastructure) is critical, particularly for the youth.
- e. *Independent Administrative Support Vertical*: Several Working Groups are currently hamstrung by the unavailability of administrative, accounting, legal and clerical support staff, with the burdens of day-to-day tasks / firefighting and in general, non-value-added tasks, holding back planning, research and execution. An independent secretariat / vertical for administrative support members, with a capacity building program, is critical if Working Groups are to effectively conduct their work.
- f. *Work plans*: Some, but not all, mandates of Working Groups require the preparation of work plans, to be tabled before the Residents’ Assembly. The preparation of these plans has been variable over the years, and where done, has not necessarily included process and outcome-based performance benchmarks, timelines, resource mobilization plans etc. A standardized process for the preparation and publications of these plans is necessary for effective work and for review processes to ensure accountability, as we discuss below.

- g. *Management of records*: the data management, archival and record-keeping processes in Working Groups is variable and in general, weak. This has led in many cases to a duplication of work, discontinuity on change of members and accountability concerns. A robust, standard and digitized data management system – for minutes, work plans, commissioned studies, reports etc. – is necessary.
- h. *Under-institutionalization and discontinuity*: institutional continuity, in terms of hand-over processes, change in policy, individual-dependent programs reflect a chronic under-institutionalization of Working Groups. In many cases, the absence of individual members results in significant delays in work.²⁴⁷ In general, Working Group and governance dynamics in Auroville are heavily dependent on individuals / personalities – an impersonalized, institutional ethic is necessary for which capacity building and training, on one hand, and a change in mindsets, on the other, is necessary for stable governance. An under-institutionalization across sectors is apparent. The growing literature on ‘new institutionalism’, innovations for decentralized, e-governance and regulatory innovation, applications of complexity theory / adaptive systems to governance (with some resonance with the systems engineering approach), New Public Management approaches etc. offer fertile ground for Auroville’s own institutional systems design.²⁴⁸
- i. *External advisors*: both due to limited internal capacity in Auroville and the benefits of engaging world-class expertise, it would be helpful for each Working Group to have an independent advisory board. Some Working Groups, particularly the TDC, have adopted this approach in the past, but with variable involvement and uptake of advisors’ inputs, leading to a discontinuation of the practice. An open interface with external experts / advisors will be critical if city-building works are to be taken up in the earnest in the short-term. As we suggest below, these advisory groups will also provide termly reports to the ‘Unity Committee’ / ‘Steering Group’ for mid-term, independent audits / accountability.
- j. *Project management / quality assurance standards*: Developing standard metrics for quality assurance and streamlined, transparent processes for project management will be necessary for city-building works. To the best of our understanding, these have not yet been developed.

²⁴⁷ Records often indicate that work is stalled because members are busy with other work, out of station or otherwise occupied, particularly in the summer months. See, for example, News and Notes, No. 762, 5. This is naturally an elementary concern that requires redress.

²⁴⁸ See, in general, Levi-Faur (ed.), 2012; Rhodes et. al. (eds.), 2006; March and Olsen, 2013.

iv. *Governance Dashboard:*

- a. *Dashboard, Enterprise Resource Planning and Data Management for Evidence-led Planning and Implementation:* a city-wide, cross-sector governance dashboard is low hanging fruit for Auroville to ensure transparent, evidence-led and efficient planning, execution and monitoring. Recent innovations in this sector in urban governance, financial management, operations and safety, human resources, strategy development, public sector services, municipal works, community engagement, project management with Enterprise Resource Planning integration etc. can be explored for technology-leveraged solutions for governance.²⁴⁹ These carry great potential for Auroville's governance future, with a range of proprietary and bespoke solutions that can be moulded to suit its unique context. Capacity training for members in these emerging governance models, and indeed, in general is serious concern in Auroville today, which will require correction as and when a dashboard / ERP is implemented. The current state of data collection and management in Auroville is weak, which hinders effective planning. A dedicated Data Management Group / Data Services will be key in this process.²⁵⁰
- b. *Professionalism:* there appeared, in some interviews, a suggestion that 'ordinary, hierarchical' management practices are unsuited to Auroville – whilst there is some truth to that suggestion, Mother's early stewardship of the project anticipated hierarchies of competence and, as the 1965 Ford Foundation letter amply demonstrates, a professionalization of executive works – goal-oriented, benchmarked, time-sensitive, technically competent and evidence-led operational processes – is the need of the hour. The excesses of technocracy, discussed above, though still only theoretical in Auroville, must not be met with professional dilettantism. Identification, training and retention of professional talent is key.
- c. *Transparency:* various concerns with transparency in the operation of Working Groups have been raised, particularly with reference to allocation / utilization of resources. As Ayer et. al. note, a 'buddy network and license raj' type of system [is] in place, impeding appropriate allocation of resources ... besides eroding trust in Working Groups.'²⁵¹ Equally, they identify, as our research too indicates, a 'systematic bias against development for growth', reflected in

²⁴⁹ See, for example, Bartlett and Tkacz, 2017.

²⁵⁰ This matter has been discussed previously in various fora, but no action has been action. See, for example, Auroville Today, January, 2015, 37 ('Today, the question of whether Auroville needs a statistical office is extensively being studied. The initiative – again – has not come from any of the Auroville working groups, but – again – from De Zaaier, this time from its new board members who visited Auroville in October 2013. 'How can you plan in Auroville without statistics?' was their simple but penetrating question to the town and financial planners, while indicating that De Zaaier might be interested to help fund a statistical office.')

²⁵¹ Ayer et. al., 2019, 28.

skewed incentives for selection in the participatory appointment processes for Working Groups. A governance dashboard, with strong data management systems and a publicly accessible information portal, can go some way in mitigating these practices.

- v. *Devolution / Subsidiarity with Sub-zonal Structuring*: processes for devolution of local works to each defined unit (ward, sector etc.) as far as practicable, along the principle of subsidiarity. This will require a delimited sub-zonal structuring. Alongside, processes for systematic harnessing of input through a Community Engagement Platform discussed below will be useful for the preparation and finalization of the Zonal Detailed Development Plans.

ii. *Selection Processes*

The 2022 Selection Guidelines currently appoint members to Working Groups through a ‘self-organizing participatory model ...’, away from ‘conventional governance’, ‘to reinforce the involvement of the community in its day-to-day functioning and a sense of dedicated sharing of the work.’²⁵² The participatory, democratic impulse is important, as we discuss below in relation to community engagement platforms, yet the question remains whether the selection of executive Working Groups is best secured through this method: the Working Groups, as such, require technical competence and qualifications – in addition to professional integrity and values, which are key to all sectors of work, whether in Working Groups or outside – to effectively conduct work. The distinction between the legislative and executive domains would ordinarily mean that the democratic impulse is primarily channelized through the former, where inclusive policy debate must occur, with Working Groups tasked with the implementation of those policies. The accountability of the Working Groups, to ensure that they keep to policy, and work with the particular community in question for collaborative implementation of projects in that locality, offer the two interfaces for community engagement in the executive domain.

However, the nexus between community participation and selection processes is unclear: as bodies that require professional expertise to effectively conduct their work, Working Groups selection must be tied to a measurement of that expertise. A fairly time-consuming process of randomly selected, group-based selection teams with anonymous feedback and a lottocracy in case of disagreement is not the best means to that end.²⁵³ Indeed, the lack of expertise and competence in Working Groups was voiced across the board by members past and present, and by professionals within the community, with some residents *avoiding* Working Groups for this reason. Equally, the cumbersome and performative nature of the process, that does not bear on the question of professionalism, competence or integrity, appears to act as a disincentive.

²⁵² Participatory Working Groups and the Selection Process of their Members, 2022, 2.

²⁵³ See, for example, Auroville Today, January, 2016, 8 (‘A three-day selection process for new members for the Working Committee and Auroville Council took place from December 4-6th. It wasn’t to everybody’s liking. ‘Once again, do we have to sit for three days to select the new members of the Working Committee and Auroville Council?’)

For Working Groups to effectively conduct the technical tasks within their mandate in accordance with the democratically decided policy framework (through direct participation, representation or the intuitive few, the three proposals discussed in our suggestions above), technical competence and integrity, not popularity, are key. As Sri Aurobindo notes:

... for the reason that it [the mind] is a common faculty of the face, it can be specialised, so much so that a man whom it is dangerous to cross in debate in the field of literature or of science or of philosophy may make a fool of himself and wallow contentedly in a quagmire of blunders and fallacies if he discusses political or economy ...²⁵⁴

A random selection of residents will not have the necessary expertise to assess technical criterion; to the contrary, a random selection processes – with selections teams operating on anonymous feedback and not required to provide reasons, with a part ‘lottocracy’, wherein inclusive decisions are decided by picking a name out of a hat – are structured to achieve the opposite, by actively avoiding technical expertise / qualifications on the selection team. Decisions made on non-public, anonymous feedback is particularly worrisome – good governance would require that selection to public positions in Working Groups be entirely transparent. As such, the means does not bear a rational nexus to the desired end. Indeed, community involvement and engagement is key, as we have discussed in some detail in this study; yet, selection of executive bodies is not the channel for that expression. Indeed, it appears that the residents’ engagement with selection processes in general is low. In 2021, the Auroville Council and Working Committee established an ‘inquiry task force’ to look into issues of alleged tampering of ballot boxes in the selection process, with an invitation for the community provide feedback to ‘improve the coming selection process’. However, ‘not a single response was received.’²⁵⁵

It appears here from various interview that there is a general distrust or aversion to granting authority to Working Groups, for fear of a ‘technical elite’ takeover – Working Groups selection is thus subject to a process of lobbying or canvassing, with the formation of interest-groups. Alongside, some interviews indicated that the short term of three years under the current Guidelines, with a term limit of six years and replacement of one-third of members every year effectively disable stable and strong action. If so, this is a worrying trend, both in terms of disguised politics and a structuring of Working Groups so as to effectively avoid action and implementation mandated by policies put in place by the community itself.²⁵⁶ Once debated and decided, a policy document – like the Masterplan, or others – requires transparent, effective and time-bound mechanisms for implementation. This is an activity that requires professional and technical expertise: selection mechanisms must then be geared to that end, which

²⁵⁴ Sri Aurobindo, CWSA, 1997, Vol. 31. Concerns with selection processes for Working Groups have been raised repeatedly in the past. *See*, for example, Auroville Today, June-July, 2014, 32 (‘Another serious issue is the constitution of our committees or working groups. There is a strong belief that those bodies, and in particular the Auroville Council and the Working Committee, should be representative of the components of the Auroville’s society. In terms of organization, one of the main consequences of this perception, when it comes to selecting those who have to assume such specific and complex tasks, is that we always miss the point by focusing on the artificial parameters of representivity rather than on the competence of the people to be selected.’)

²⁵⁵ News and Notes, No. 872, 2021.

²⁵⁶ *See*, Ayer et. al., 2019, 28.

participatory methods are, by definition, unsuited for. The rationale for the term limit of six years is also unclear – provided that the member’s work is technically and otherwise competent, with accountability mechanisms in place, reason would dictate that the experience and expertise of that member must continue to benefit the work of the Group. Equally, while hand-over process and institutional continuity are key, as discussed above, a revolving-door replacement of a third of the members every year introduces an avoidable uncertainty in processes. In general, the appointment of Working Groups should be open to any member of the community with the necessary expertise and qualifications, with a transparent, reasoned-out and expert-led selection processes. There are various design calls to be made in designing such a system, which we do not enter here, yet it is important to match the nature of the selection process – participatory, random, anonymous – to the nature of the body being selected – executive, expert / professionally driven.²⁵⁷ The participatory ideal is important, yet respectfully, in our view, misplaced in this particular context. If deemed necessary, the Residents’ Assembly may – as the representative body – select one member for each Working Group, to act as a channel for accountability and feedback: to ensure that Working Groups are adhering to policy, and to allow for policy inputs from Working Groups to be routed back to the Assembly. This may balance the participatory and technocratic concerns.

The next consideration that emerged in interviews was in relation to *intra* Working Group dynamics – as in the case of the TDC in 2017, various Working Group members, past and present, indicated that internal disagreements have often gridlocked operations and resulted in delayed action. Three points emerge in this context. First, as we propose above, policy matters – which seem often to be the cause of the disagreement – are not in the domain of the Working Groups, and as such, once decided, all members of the Group are bound. Second, to counter-act internal disagreements, particularly when selections are made precisely to ‘balance’ Working Groups with opposite views, we suggest that selection to Working Groups (through the expert-led body we propose, or by the current participatory method) be *contingent* on the preparation of a commonly agreed-upon plan by all members. In this format, provisional selections may be made on individual merit, following which the group so selected is given a defined period of time to arrive at a common work plan for their term, along defined metrics (proposals, projections, outcomes, resource and personnel requirements etc.). If all members are able to arrive at a common plan for implementation, their selection is confirmed; if not, the selection process is repeated. This adds a layer of complexity, but given the history of Working Groups being unable to agree on a single implementation strategy, it would be wise to assess group dynamics before, rather than after, appointment to learn from past practice and avoid instances such as those in the TDC in 2017. As Mother noted, effective work is possible only if all members are on the same page:

This change was necessary for the worker’s spiritual development. He has to become aware of my influence inwardly. But he can receive it only if all the workers collaborate. Without collaboration the right inspiration will not be effective. The action from above has a wide sweep: it covers all the departments and is one harmonious whole. If walls are set up in the field of work, dividing and breaking it up, the work can never be according to the spiritual Will.²⁵⁸

²⁵⁷ See, for example, Keheo et. al., 2012.

²⁵⁸ Mother, CWM, 2002, Vol. 13, 160.

Equally, this work plan can signal to the community the range of work to be expected, giving time for reflection, study and alignment, and as work proceeds, serve as the basis for the Unity Committee, discussed below, to ensure mid-term accountability for the Working Groups. In sum, we suggest a structure of selection processes for Working Groups along the following lines:

- i. Notification of defined criterion / qualifications for Working Groups, with internally defined streams.
- ii. Transparent selection as against notified criterion by an expert-led body, constituted by the Unity Committee (proposed below, or otherwise).
- iii. Selection of a Chairperson, either through the same process or if deemed necessary, by participatory methods, through the Residents' Assembly, for a legislative-executive channel.
- iv. Selection of Working Groups contingent on all provisionally appointed members developing a common Work Plan for the duration of the term.

iii. Accountability

Accountability processes for Working Groups in Auroville are generally weak – given their heavily circumscribed executive power, this was in a sense understandable. Yet, with clarified mandates and executive powers, necessary for city-building, accountability must follow. For this, we propose an independent Unity Committee, comprising members from one of each of the six zones, to ensure city-wide representation. This body, proposed in a different form earlier by Professor Joshi and the International Advisory Council, is tasked with: (i) overseeing selection of Working Groups, (ii) ensuring accountability of Working Groups to defined Work Plans, (iii) dispute resolution, as discussed above, and (iv) inter-sectoral coordination.²⁵⁹ This group has functions that partially overlap with the mandate of the Working Committee and Auroville Council, which we suggest are reincorporated here / the Auroville Council is merged or expanded along these lines (the nomenclature aside).

The Unity Committee is not a ‘super-regulator’ that must approve executive actions, or may alter them, a format previously experimented with in various groups which yields unnecessary complexity and delays; nor indeed is its constitution geared to substantively review executive or technical matters. Rather, it is tasked with regulatory oversight (an administrative and quasi-judicial function) – to ensure transparency, adherence to policy / defined work plans, dispute resolution and inter-sectoral co-ordination. In this, it may be provided defined and circumscribed powers for removal of a member and / or enforcement, with a single review to the Steering Group. Each Working Group, for its part, may be required to provide termly reports – light, standardized and digitized through the Governance Dashboard, to minimize administrative burdens as far as possible – to the Unity Committee for its review, along with

²⁵⁹ See, Joshi, 1999; Auroville Today, March, 2007, 2.

independent assessment reports by the Advisory Boards. The Unity Committee, for its part, may provide termly updates to the Steering Committee, thus allowing for a simple, effective and balanced accountability mechanism. Enforcement and review powers are naturally to be cautiously exercised, both to avoid exclusive concentrations of power and regulatory inflation – processes and codes defining these functions thus will require careful detailing-out to facilitate light but tight mechanisms, with a two-tiered system ensuring checks and balances. If the executive conducts itself well, these mechanisms will be negligible; however, if – as is natural in the course of evolution – there are excesses, these may be identified and addressed.

The Steering Group, in this template, comprises four members – Chairman (or nominee) of the Governing Board, International Advisory Council, Council of Residents and the Council of the Wise. In this, it allows for an effective representation from all three statutory bodies, who otherwise do not have a defined forum for common action and collaboration. The final authority for enforcement, and guidance, may thus emerge from the collective authority and wisdom of this body, which is tasked not with day-to-day management (a matter left for the internal organization of the Residents' Assembly), but rather, oversight and guidance. In this, it provides an institutional form for mutuality to emerge amongst the various branches of the Foundation and avoid parallel governance tracks.

iv. Enforcement and Dispute Resolution

The hard edge of legitimate authority – principles of which we have discussed above – is enforcement. The stability and productiveness of Auroville's social contract will depend on a consensual, voluntary and in the ideal, fraternal discipline to allow for decision-making and implementation. A non-coercive and stable system can only sustain itself on this basis. Yet, in that process disagreements are bound to arise, and in cases, enforcement – through soft and hard means – may be rendered necessary. As we discuss in Section E, ideally, Sri Aurobindo and Mother contemplated a progressive substitution of rule-enforcement for 'spiritual compulsion' – yet, in that journey, judicious and careful mechanisms for the former will likely be required.

This is a particularly knotty question for Auroville. The absence of a final arbiter – a function usually performed in political systems by the judicial branch – is intentional and with good reason: as the fallibility of individual assessment in matters of the spirit cannot be ruled out, one is distrustful of an intermediating authority that risks entrenching a body that claims the exclusive right to determine the truth of the matter. This fear of granting exclusive authority is of course backed by history, though at times exaggerated. Mother's dream that residents will 'obey one single authority, that of the supreme truth' pushes us away from a final, institutional authority in Auroville, yet her constant emphasis for the need for guidance by an intuitive few, also reflected in her early organization placing trusted disciples at the helm of various sectors, brings us back to it.

In practice, absent a statutory system to resolve disputes in the AVF Act (as we discuss in Part V), a stable working organization in Auroville relies then either on a generally high level of individual sincerity and illumination in the community (to arrive at a unified decision, or go

along with decisions with one does not agree with for the sake of solidarity) or on voluntary submission to a council of wise individuals who inspire trust by their realization and whose decisions each agrees to abide by. The constraints of working a practical system that keeps things going in the face of disagreement, requires the buck to stop somewhere to avoid interminable dialogue: these decisions are fallible, but final. Any ideal system requires some concessions to be made to reality. The Auroville community must therefore make choices within this frame, absent which cohesive action is difficult.

This is a long-standing problem in the organization of collectives, an area in which comparative research in Auroville can produce meaningful results.²⁶⁰ If each side claims truth (and indeed, one of them is actually true – to avoid, as we often did in our conversations, an easy slide to relativism), the ideal situation is for mutual persuasion between residents to arrive at common ground either as consensus or accommodation. Yet dialogue may not result in agreement, even if well-intentioned, or may act as a strategic move to block movement, if not. In either case, if that agreement that does not obtain, as is often the case in Auroville, political systems ordinarily establish independent decision-making processes to resolve the matter, in an expert-constituted judicial or other popularly selected authority, usually a legislative assembly. The point of such authority is precisely ‘to enable to us to act *in the face of disagreement*’, to ensure that action is not inordinately held up by a failure to arrive at consensus.²⁶¹

One must have a chance to persuade one’s peers, and expect that others are open to being persuaded; yet if that does not happen, an independent judgment call (through some arbitrating forum, with a final say) is required. But equally, it did not legislate an argumentative ‘free for all.’ In doing so, it places a concomitantly *greater* responsibility on all involved to voluntarily resolve disputes in a spirit of goodwill, or as we have suggested, establish such a system internally that responds to the sensitivities of Auroville’s unique aspirations – our proposal here for a voluntary submission to tiered dispute resolution bodies, leading to the Unity Committee and Steering Group addresses this point. This is embedded in Mother’s suggestion of the principle of illumined hierarchies discussed in Part I. For practical day-to-day decisions, execution of development plans etc. – as opposed to fundamental matters on Auroville’s spiritual vision, cases of deep disagreement, where one perhaps has greater reasons to be disinclined to a final arbiter – some final authority mutually agreed upon by the community seems necessary to allow for cohesive action to move forward after due debate. Working such a system, as we noted, requires resting goodwill in that authority to abide by decisions arrived after fair consideration. If the Auroville community is able to operationalize such a system, currently under stress with pending matters in the Supreme Court and High Court of Madras, it would be an important achievement that can set an example for collectives elsewhere.

The judicial / enforcement mandate currently lies with the Auroville Council, under clauses 5, 7 and 9 of the 2004 mandate. Records indicate that the Council members are generally reluctant and under-resourced for this task, with several cases of non-compliance posing persistent concerns. The 2017 Appeal Process was slated for review in 2018, but to the best of our

²⁶⁰ See, Waldron, 1999 for a detailed discussion on formats to resolve disagreement.

²⁶¹ Waldron, 1999, 7.

understanding, this has not yet happened. In general, a systematic review of reviews / appeals requested, decisions and enforcement since 2017 under the process would be helpful to allow for future planning.²⁶²

In terms of the structure, we propose that the Unity Committee proposed above, sitting individually or *en banc*, be constituted as the standing forum for dispute resolution and enforcement, with a final review – in defined circumstances, for matters of general concern – by the Steering Group, thus placing a system of checks. As opposed to the current system of *ad hoc* ‘arbitrations’, we propose that processes and decision-making formats be standardized and defined, with external support for training and internal capacity development. Some concerns have historically been voiced in this regard, to avoid a litigative setup, manage conflicts of interest etc, training in conflict resolution etc.²⁶³ These are beyond the scope of our study, yet we may note that these are easily solvable with an appropriate instrument for mediation and dispute resolution. This need not lead to a complex adjudicative format, if appropriately drafted and managed. Community arbitration mechanisms at the zonal and sub-zonal levels for quick and local resolution relying on residents that may avoid an escalation to the Unity Committee would also be useful – solutions offered in the area can be explored.²⁶⁴ The concerns with avoiding litigiousness are weighty: as in any collective, including one aspiring to a spiritual anarchism, a sensitive yet firm enforcement mechanism is necessary to avoid backsliding; yet if operated along fraternal principles, its usage will be minimal.

Accordingly, we propose the following template, for which mechanisms and processes can be detailed out if considered viable:

- i. Between residents:* disputes between residents can be resolved at the most local level possible through mediation / arbitration in sub-zonal groups (ward, sector, Zonal Group as necessary), to incentivize decentralized solutions, with only one level of limited review.
- ii. Between residents and Working Groups:* disagreements between residents and Working Groups, if unresolved through discussion, can be resolved through approach to the Unity Committee. If the disagreement persists, and the Unity Committee considers the issue to be one of general importance, it can refer the matter to the Steering Group in its discretion.
- iii. Within Working Groups:* disagreements within Working Groups that lead to delays in execution can be referred by any member of the group to the Unity Committee. If the disagreement persists after a decision by the Unity Committee, and the latter considers the issue to be one of general importance, it can refer the matter to the Steering Group in its discretion.

²⁶² See, Auroville Today, May, 2021, 25.

²⁶³ See, for example, Auroville Today, June-July, 2007, 6.

²⁶⁴ See, for example, the work of the Centre for Online Resolution of Disputes.

- iv. *Between Working Groups*: disagreements between Working Groups, if unresolved through dialogue, can be mediated by the Unity Committee. If unresolved, either Working Group may approach the Steering Group for final guidance.
- v. *Intra-Foundation*: disagreements between the three statutory bodies can be resolved at the Steering Group, to allow for a mutuality, with a decision by consensus as far possible.
- vi. *Intra-bioregion*: disagreements between residents of the Green Belt or others in the plan area, if unresolved through mediation between the concerned Aurovilian / Working Group can be resolved through a permanent mediation/arbitration forum established by way of an MOU with one representative of the panchayat and Unity Committee each, and if required, a third member.
- vii. *External*: legal disputes before the judicial or quasi-administrative fora against any Working Group / Foundation are ultimately supervised by Governing Board / such other sub-committee as considered fit by Governing Board, with inputs from the relevant Working Group.

v. *Community Participation and Co-Production*

Executive power of the Working Groups to implement policy must, in the usual course, have a structured and deep engagement with the community. The participatory impulse outlined the 2022 Selection Guidelines is best channelized at the level of implementation, where the residents may effectively engage in the execution of concrete projects in their neighbourhood, ward, sector or Zone. As we discussed above, the value of participation is tied to its how meaningful / inclusive, effective, informed / competent, quick and conclusive it is. Whilst Working Groups have centralized, executive mandates for implementation, the immediate beneficiaries of these works are the residents of the particular community: their inputs, participation and active involvement is thus necessary for the manifestation of the physical and social environment as a reflection of the collective spirit, the planning ideal outlined by Anger. It is in this context, for example, that the 2017 TDC-TOR frontlines participatory models. That said, given concerns with inflated and unstructured participatory mechanisms in past, discussed above, efficiency concerns too weigh heavily. The challenge here is in designing effective, meaningful and time-sensitive mechanisms for participation in the exercise of executive powers by Working Groups, that can allow for a shared, yet, urgent, manifestation of the city. This requires careful detailing-out, in which the following points are relevant:

First, community engagement is best had in small aggregates, at the sub-zonal level. This both increases meaningful participation, where residents are likely to be better informed, more inclined to contribute and arrive at consensus, and reduces the possibility of unstructured filibustering. As discussed above, execution works, particularly in relation to town planning, are thus best defined through a firm sub-zonal architecture: in this, residents' living, for example, in community 'x' in Sector 1 of the Residential Zone will be directly consulted in developing that community; all communities within the neighbourhood or ward are consulted for the common elements in that area and so on. As one rises to larger areas, the consultation /

participation becomes representative, rather than direct. Developing this sub-zonal implementation / participation architecture is critical, both in terms of the efficiency of the process – a concern given unstructured participation, leading to delays, in the past – and the development of communal self-belonging. They operate, then, as ‘communities of practice’, which are ‘the prime context in which we can work out common sense through mutual engagement.’²⁶⁵ To the best of our understanding, this architecture has not been created in Auroville.

Second, as the Working Groups are ‘centralized’, we suggest a ‘Zonal Group’ as the executive arm of each of the four zones (with a Zonal Assembly as the legislative arm). This Zonal Group allows for an executive interface between the community of that zone and the Working Groups, the rationale behind their inclusion in 2008, though not practiced as such. Accordingly, each Working Group may, as necessary, rely on the Zonal Group, for zonal consultations / implementation, with defined processes for devolution of development works. In our proposed structure, all sub-zonal groups (for example, SAIER in the Cultural Zone, National Groups / Continental Clusters in the International Zone etc.) operate within the umbrella of the Zonal Group. This architecture, as we discussed above, is currently only partly and vaguely articulated – it will require detailing-out to for streamlined, cohesive organization. Centralized Working Groups are thus supported for zonal works by each group, forming a framework that is sensitive to the centralizing – decentralizing dynamics in Sri Aurobindo’s work discussed above.

Third, effective participation requires concrete projects at hand. Policy debates are had in the Zonal and Residents’ Assembly; implementation debates in relation to Working Groups require concrete plans and time-bound projects, in which community co-production is undertaken. In this, it is important to note that whilst Working Groups may and must aspire for consensus – soliciting good ideas, being open to criticism and iterative changes as circumstances change – , the executive power to finalize plans and implement lies with the Working Groups. No further ratification by the Assembly or the community is necessary, which is *already* reflected in the policy that guides and constrains the Working Groups. A circular ratification of executive works a second time is unhelpful. In the extreme, if Working Groups are not consultative, on one hand, or reasonable disagreement persists / non-compliance results after a reasonable time frame for find common ground, the dispute resolution and enforcement mechanisms may be engaged to keep both the Working Groups and the community accountable. In the ideal, a fraternal setup, with debate and ultimate consensus (of the second kind discussed above, not necessarily universal agreement) at the sub-zonal level, can allow for inclusive and urgent implementation. Given historical concerns with resistance to increasing densities and development works, it is key that participation is meaningful and effective, rather than dilatory.

Fourth, the discussion on the value and burdens of participation in relation to the Residents’ Assembly in Section B applies with equal force here, and must inform governance choices. The nature of participation in relation to executive bodies, the Working Groups, brings some additional issues to consider. First, deliberation here will ordinarily be in the practical context of particular development projects, rather than policies, where sub-zonal / ‘local’ participation of those specially affected is key. This is for prudential reasons (as development cannot proceed

²⁶⁵ Townley, 2008, 123; Mason, 2010.

without community support),²⁶⁶ moral reasons (those specially affected should have a say in how their immediate environment is shaped) and strategic ones (as the lived experience of those in the community can enrich the planning and execution process). Second, there will likely be technical matters in relation to implementation, where the nature of participation will require careful calibration to be meaningful. As Khwaja notes:

... while community participation improves project outcomes in nontechnical decisions, increasing community participation in technical decisions actually leads to worse project outcomes.²⁶⁷

The nature and intensity of participation, and the weight it bears on the Working Group's decision, must therefore be tied to the nature of the subject-matter in question, as between technical and ideative issues. Robust and institutionalized capacity-building initiatives – of the kind in the Citizens' Assembly Pilot, Auroville Campus Initiative and the City-Wide Embedded Learning Platform proposed above – are indispensable for meaningful participation; yet, in matters – say of sustainable energy design, infrastructure development, economic planning, mobility systems etc. – where professional expertise is key, participation may take a limited form of awareness-generating or consultative-mechanisms. The weight of authority to decide must, in other words, gravitate to the 'most enlightened centre.'

The concern raised at the end of the Citizen's Assembly Pilot, which will *per force* be faced with participatory methods in the executive domain, is the knowledge gap in technical matters that places a cognitive glass ceiling on what informed and spirited residents can and should reasonably do. Ideative and policy issues in the legislative domain, to frame the vision, are particularly suited to deliberative methods, yet executive matters that require expertise to plan and implement will require a different balance to marry the often conflicting technocratic and democratic impulses:

Among the Water Players, there were many who expressed their surprise at the extensive scope of both the vision and the suggestions for implementation considering that the participants were not 'water experts'.

[Yet:]

The recommendations were perceived by the water players as rather broad with no clear pathway for materialising the recommendations. This may be due to a difference in expectations from the water players. The objectives of the assembly were to come up with a vision and suggestions on steps for ensuring the vision could be implemented. It was not intended to provide a pathway for materialising the recommendations as it was felt this next step would need to be developed by the water players (especially those with technical and governance expertise). 29

²⁶⁶ Billinger and Schmidt, 2005, 21 anticipated problems along these lines for mobility planning, with apply equally to other sectors: 'To scale down the freedom of movement of motor-vehicles (motorbikes and cars) in Auroville requires tact. A majority of Aurovilians need to be convinced of the advantages of a motor-free city. This requires a process of information. If a change is brought about, *nobody should be able to claim that they did not know anything about it, or complain of a undercover action*. The process of forming public opinion can be supported by realisation of motor-traffic free zones in small steps, which can, if necessary, even be tried out for a time so that ample practical experience can be obtained. Another proven method is to combine a change in traffic use with a structural improvement of the street, so that after the improvement the new usage is accepted as natural.' (emphasis ours).

²⁶⁷ Khwaja, 2004, 428. See, Fischer, 460-2, in Levi-Faur (ed.), 2012 for a review.

I would like to see how the ‘executors / implementation bodies’ become more integrated in the CA process.

... more clarity of way forward in the implementation guidelines and that the outcomes seemed very broad.’²⁶⁸

As we saw in Part III, this issue – of who gets to finally decide, the question of legitimate authority in Auroville’s social contract – has been a governance bottleneck, with an erosion of trust between the community and Working Groups hampering development as a result. Clearly defining the nature of participation and authority to decide on implementation in the executive, as opposed to legislative, domain will thus be key. Our proposal above suggests that strong participatory process can aspire to consensus (of the first or second order) on the implementation of particular projects to manifest a unified will; disagreements, however, will likely persist in a plural collective and it is thus wise to strengthen the executive authority – of the relevant Working Group, assisted by the Zonal Group, in our proposal above, that is ‘locally’ rooted in the community – to resolve issues and implement in line with the principle of illumined hierarchies.

That said, it appears, both in the records and from our interviews, that most concerns *can* be resolved through careful and structured processes of resident engagement that build awareness, trust and goodwill, which are at times scarce commodities. In this task, it is important to emphasize – as we noted in relation to the TDC Interface Team in Part III.A – that generating meaningful and action-oriented resident engagement is itself a distinct skill-set, one that requires training to develop ‘participatory expertise’.²⁶⁹ Working Groups across the board will then have to consciously build capacity and pay special attention to the means and methods by which they can harness collective intelligence and interface between lived realities and expertise, on one hand, and avoid filibustering, minority capture, interest-based negotiations and vetos, on the other. This is naturally a highly context-specific exercise in which Auroville’s Working Groups will have to innovate methods suited to the community.²⁷⁰ The literature speaks to various experiments in digital and physical crowd-sourcing and community engagement platforms that can be explored to this end: visualizations, simulations and augmented reality setups, fuzzy cognitive maps and explainers for reports, studies etc., with automated translation services, a digital library of expert-led videos for asynchronous consumption, skills-training for facilitated deliberation (as in the 2021 Citizens’ Assembly Pilot), virtual town halls (for example, Mind Mixer), webGIS and Urban API solutions, ‘consensus conferences’ etc.²⁷¹ The 2022 Dreamcatching forum, discussed in Part III.A above, merits special attention as a creative attempt to bring expertise and popular participation together that may serve as a model for the future. To conclude, we may only underscore the

²⁶⁸ Citizens’ Assembly Pilot, 2020, 19, 29, 27, 31.

²⁶⁹ Fischer, 467, in Levi-Faur (ed.), 2012.

²⁷⁰ See, Bobbio, 2019; Pereira et. al., 2018; Certoma and Rizzi, 2017; Liu, 2017; Sudhipongpracha and Wongpredee, 2016; Harvard Business Review, 2020. See, for a helpful conceptualization of design principles for the urban commons, Foster and Iaione, 2016.

²⁷¹ For a particularly optimistic take on collective intelligence in public works, see, Landmore, 2012. There is a flourishing literature on mechanisms to harness collective intelligence, avoid ‘groupthink’, networking and crowd-sourcing options and mechanisms to enhance community leadership, which offer an interesting and practical debate from which Auroville can benefit, and in time, contribute its experience. See, for example, Dyer et. al., 2008; Fontanari and Rodrigues, 2016; Gergber et. al., 2012; Gomes et. al., 2019; King and Cowlishaw, 2009; Neil, 2020; Liu, 2017; Mason et. al., 2008; Van Bussell et. al., 2020.

importance of this community-facing province of Working Groups, if city-building is to be an expression of fraternity, the material expression of a collective spirit as Mother envisioned.

*

D. INSTITUTIONAL TEMPLATE

Given our overview in Sections A-C, we suggest the following organizational structure and design principles.

i. Organizational Design Principles

Residents' Assembly – federated, representative bicameralism:

- i. Bicameral Residents' Assembly with a Council of the Wise, with either strong powers that require their assent, weighted voting or a return of the Residents' Assembly Decision for reconsideration.
- ii. Institution of flexible procedural rules for channelized deliberation in the Residents' Assembly, with defined agenda items, record of attendance, transcription of debates, prior intimation of questions, circulated answers / documentation from the relevant Working Groups, committees for study reports, principles of debate with 'stop procedures' etc. to assist in informed deliberation, allocated discussion time, open hour etc.
- iii. *Ad hoc* or permanent (i.e. Select or Standing) sub-committees comprising residents with expertise to provide written input on the agenda to assist in informed deliberation and consensus. This includes referencing any proposal to previous community discussions, Residents' Assembly meetings, Working Group reports / documents, international best practices etc. to avoid recycling of issues.
- iv. Reconsideration of all residents meeting in a single assembly requires reconsideration as numbers grow. Models of federated representation can be studied for this purpose.
- v. Compiling, archiving, indexing and making publicly accessible all previous Residents' Assembly meetings, with Residents' Assembly decisions.
- vi. Strengthening and capacity building of the Residents' Assembly Service.

Federated (zonal and sub-zonal) organization:

- i. Incorporation of federated, appropriately decentralized systems of decision-making, with decision made as close to the community / group affected (Zonal or sub-Zonal Groups), with appropriate funding allocations from Working Groups, and accountability mechanisms.
- ii. Firm definition of zonal and sub-zonal architecture, with neighbourhood, ward, sector, zonal level bodies, for accountable local action.
- iii. *Ex officio* inclusion of chairmen of Zonal Groups in Working Groups as appropriate, for smooth functioning.

Subsidiarity:

- i. Institutional models that allow for local decision-making and execution at sub-zonal levels, with by Zonal Groups mediating with the centralized Working Groups.

- ii. This requires appropriate budget allocations to the sub-zonal groups, and an identification of subject-matters, projects etc. that can be dealt with at each level.

Engaged mutuality between the statutory bodies:

- i. Combination of Governing Board appointed, and Residents' Assembly nominated working groups.
- ii. Rationalization of working groups / committees under Sections 16 /19(3) of the AVF Act.
- iii. A four-member common forum for monitoring and evaluation (Steering Group), comprising chairpersons or nominees of the Governing Board, Residents' Assembly (both houses) and International Advisory Council.

Working Groups - illumined hierarchies, with collective discipline:

- *Selection:*

- i. Developing a dedicated, easy interface online portal to manage selection processes ('RAS Portal').
- ii. Expert-led, expert-constituted selection body, recalibration of 2022 Guidelines; selection process to require pre-defined technical capacities and prior experience. Minimum experience of one / two years as a resource person serves as a qualification requirement. Standard, defined, written work-plans (with work outcomes, timelines, resource and personnel requirements, resource mobilization plans, constraints, risk identification etc.) and a review of prior work for Auroville, with page limits, can be uploaded digitally on the RAS Portal by each candidate, on the basis of which selection is made. Where possible, the termly evaluation and monitoring report from the candidates' previous Working Group can be shared, to evaluate prior work.
- iii. As alternative proposals, (i) both preliminary and final selections to be conducted by the Unity Committee, in consultation with residents through a feedback channel on workplans and presentations, or (ii) preliminary and / or final selections to be conducted by the Steering Group, in consultation with residents through a feedback channel on workplans and presentations. This assumes / requires trust in the Committee / Steering Group.
- iv. Provisional selection of Working Groups by the Residents' Assembly, subject to members providing a commonly agreed action plan within a stipulated time, with outcomes, timelines, resource requirements etc., to allow for cohesive work. No confirmation absent common plan.
- v. Selection of chairpersons for Working Groups by the Residents' Assembly, as legislative-executive linkages.
- vi. In the interim, simplifying the Participatory Working Groups Selection Process – with reconsideration of multiple presentations, anonymous weighted group-voting etc. – to reduce time burdens that hamper effective participation;

anonymous feedback to be discontinued, to allow for public and transparent debate; reconsideration of the ‘hat’ rule and random selection processes.

- *Operation, Review and Monitoring:*

- i. Increasing terms from three to five years to allow for effective implementation; remove term limits.
- ii. Identification of part-time and full-time roles in the Working Groups, with appropriate maintenance allocations.
- iii. Working Groups to have an internal steering member, as the Chairperson, tasked with monitoring and evaluation who submits standard-form termly reports to the Unity Group internally, and the Steering Group, externally, to measure actions taken as against the proposed action plan.
- iv. Culture of decision-making and execution. Community consultation within a defined-time frame mandated for Working Groups, leading to but not bound by consensus, for formulation of plans, but with executive authority for implementation once decided.
- v. Clear demarcation between legislative and executive mandates of Residents’ Assembly and Working Group respectively. Empowering Working Groups with strong executive mandates, and holding them accountable to pre-defined goals.
- vi. Appropriate limits to total number of Working Group members as a percentage of population, to avoid regulatory creep.
- vii. A suggested Residents’ Assembly Decision to discourage canvassing, lobbying, special interest groups etc., for the selection process.
- viii. Development of a Governance Dashboard, Data Management System and ERP integration for transparent, evidence-led and efficient planning, execution / project management and monitoring.

- *Engagement with external expertise:*

- i. Panel of external experts (formalized as an ‘Advisory Group’) for each Working Group, for consultation and mid-term accountability.
- ii. Advisory Group to support external monitoring / review processes undertaken by the Unity Group and Steering Group, where necessary.
- iii. Advertisements / public job descriptions with a competitive process for retaining external experts / consultants for designated projects.

- *Simplicity in organization and processes:*

- i. Smaller, manageable and clearly defined Working Group mandates.
- ii. Identification of areas of joint work / overlaps, with streamlined processes for joint-sitting, approvals etc.
- iii. *Ex officio* inclusion of chairmen of Zonal Groups in Working Groups as appropriate, for smooth functioning and to avoid regulatory inflation.

- iv. A centralized dashboard, migration of administrative processes online through a centralized Enterprise Resource Planning system, with digital, automated and time-bound approvals where possible.
 - v. Standardized and short termly reporting mechanisms for Working Groups, for easy and efficient public awareness.
 - vi. Centralized audits and accounts.
- *Building capacity in management and administration:*
- i. An independent vertical / common administrative, managerial / human resource pool, with common accounting, auditing, legal compliance etc., for Working Groups, to reduce day-to-day burdens. Capacity building plan for administrative, clerical support staff, with strategy for bio-regional skilling and employment for such tasks.²⁷²
 - ii. Leveraging smart technology solutions – Dashboard, ERP, data management and analytics – for efficient administration.
 - iii. Institutional continuity through common managerial / administrative setups, with standard archival processes for agendas, minutes, reports etc., and an end of term review / hand-over report.
- *Rationalization of codes, policies, customs etc.:*
- i. Collating, condensing and / or (re)drafting codes, policies, customs in plain language (translated across major language groups) for easy access and operation.
 - ii. Redrafting Working Group mandates to reflect current operational realities.
 - iii. Identifying areas of collaboration / overlap between Working Groups with defined processes for joint meetings, process maps, decision-making in a time-bound fashion.

²⁷² This work was begun in 2019 as part of the Human Resource Initiative ‘to address the gap between the work opportunities within Auroville and the individuals qualified to take them up ... They put together a proposal for a comprehensive Auroville-wide human resources service and presented it to the FAMC, Budget Coordination Committee (BCC), and Auroville Council. Sadly, HRI did not get the budget it had requested, which could have covered the maintenances for HR staff and offered the potential to organize skills development training for work seekers in Auroville.’ Auroville Today, October, 2019, 49.

ii. *Suggested Templates*

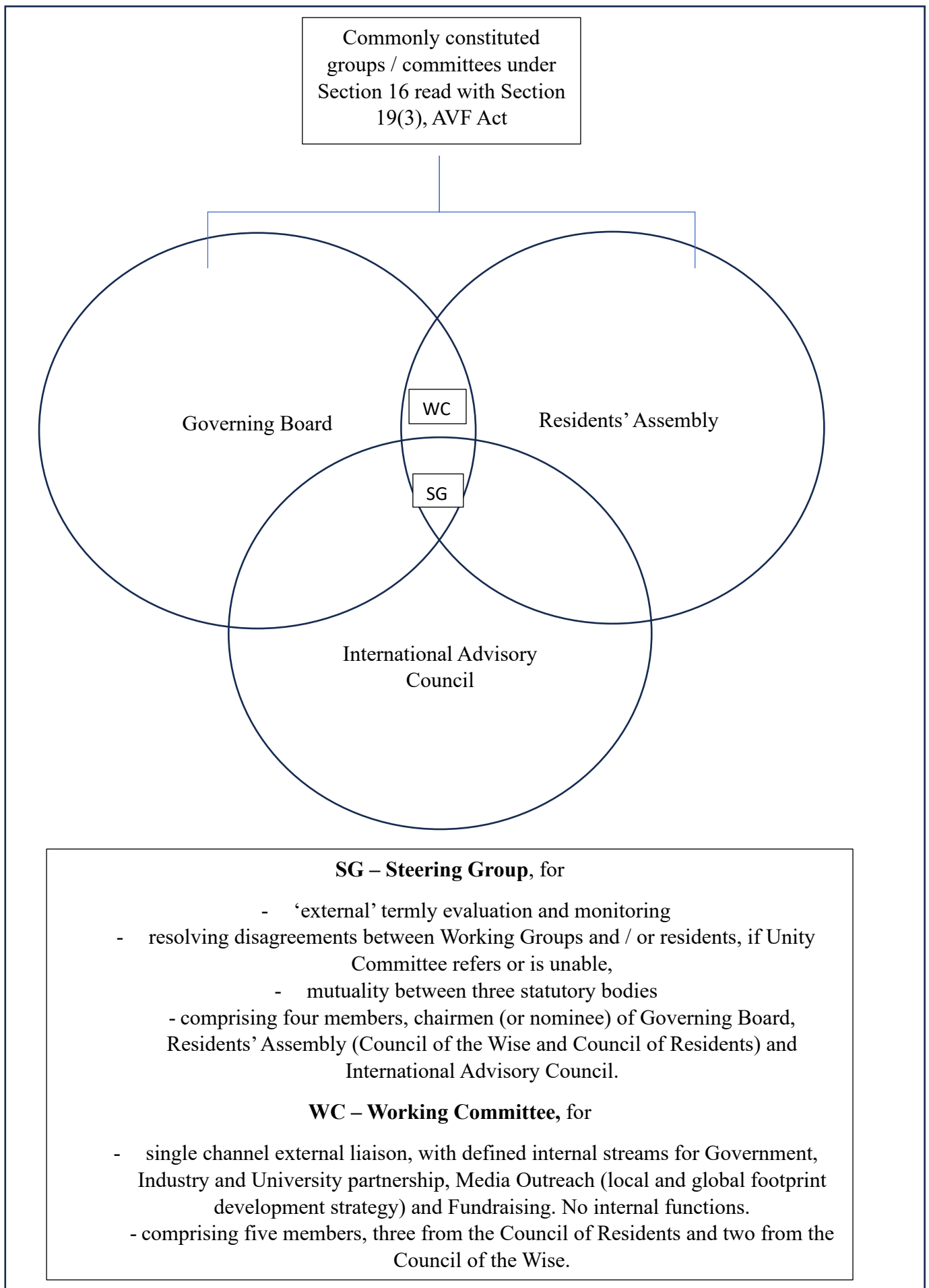

Governing Board, Section 16 Committees

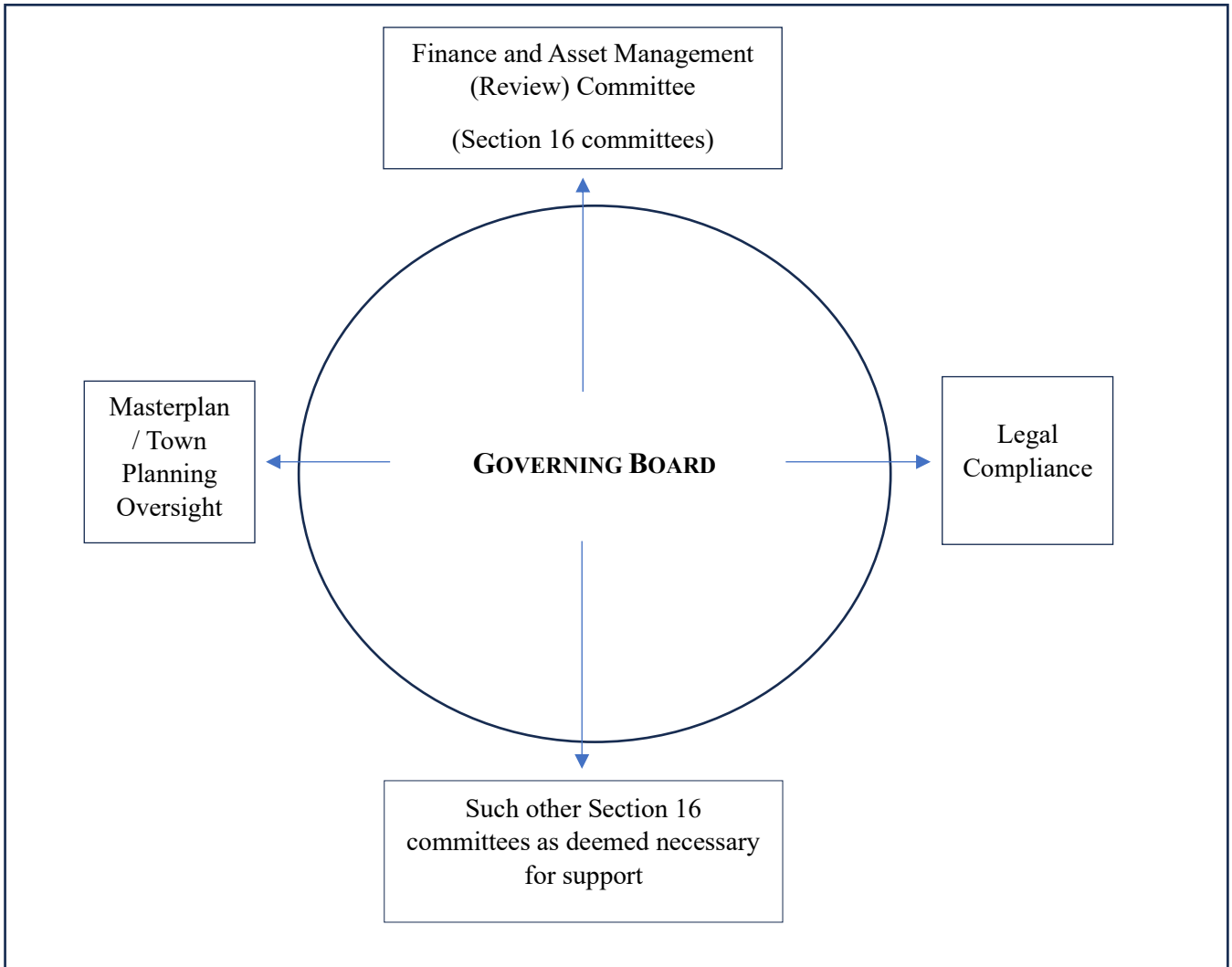

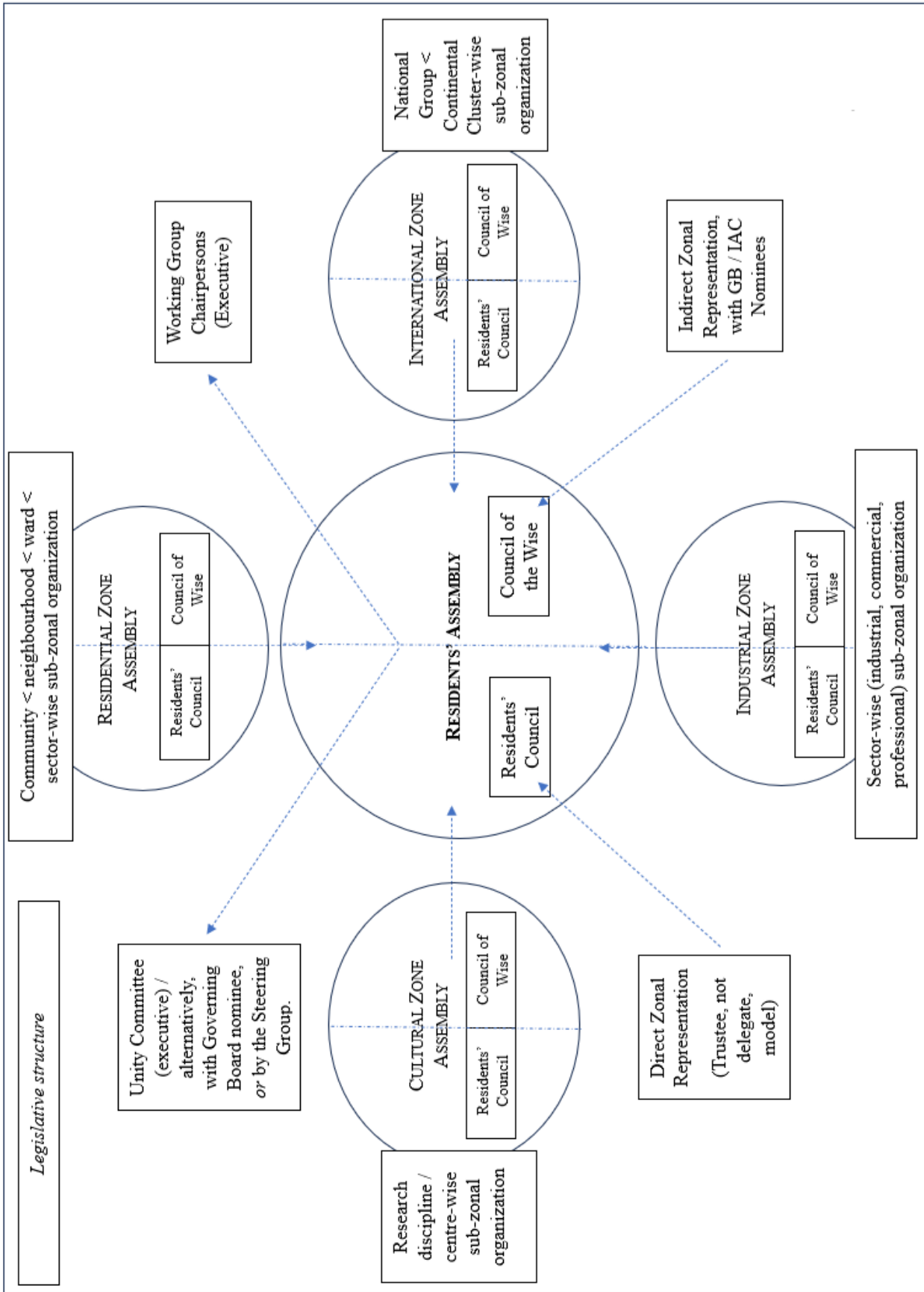

Executive Structure

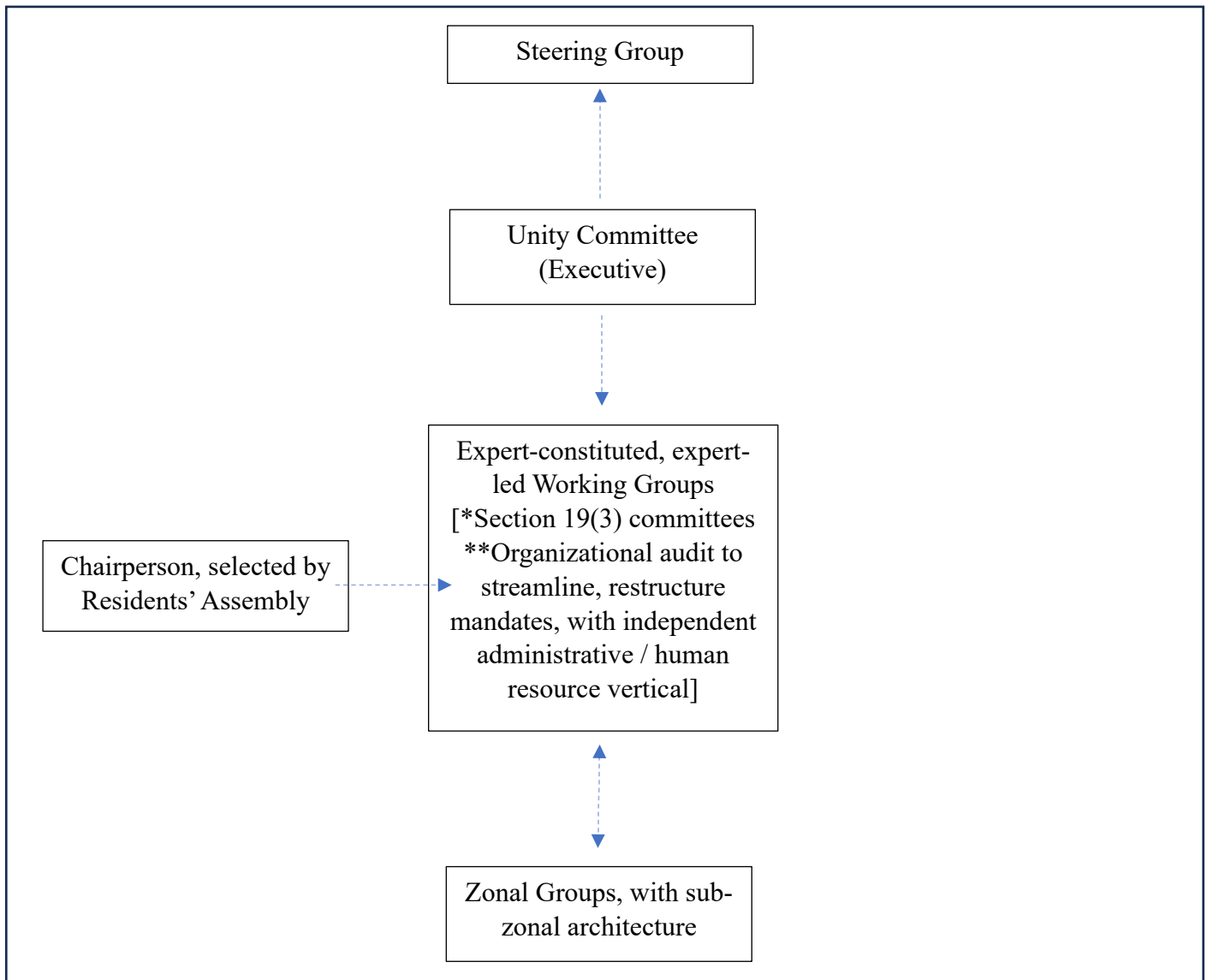

***Rough template for restructure:*

1. Working Committee (exclusively outward facing – government liaison, partnerships, and media)
2. Town Development Council (Interface and Technical Team + Land Management / Board + Municipal Board and Services)
3. Housing Board
4. Ecology / Green Group (Farm and Forest Group)
5. Economy and Finance (Financial Affairs (Budget Coordination, Financial Services), Economic Planning Group +)
6. Human Resources and Administrative Services (Administration, Legal, Clerical Support, Accounts and Audits +)
7. Data Services
8. Entry Board
9. Education, Research and Culture (Research Group, SAIER, CIHRU +)
10. Outreach Board (AVAG, Health, Education, Environment clusters +)
11. Health and Medical Services
12. Security Services

E. PUBLIC CULTURE

As we outlined in Section A, the formal governance mechanisms discussed in Sections B-E above are, in the final analysis, dependant on the cultural atmosphere – the inner determines the outer. In this context, five issues merit reflection: (i) assimilation, outreach and entry processes, (ii) exit mechanisms, (iii) the link between rule enforcement and spiritual compulsion in Auroville's public sphere, (iv) stewarding the public culture and finally, as a closing remark, (v) the place of Mother and Sri Aurobindo in Auroville.

i. Assimilation, Entry and Population Growth

Our discussion in Parts I-III outline the concerns attendance with Auroville's slow population growth, and particularly, the dangers of insularity. Auroville's current population numbers, and slow growth, have raised chronic concerns with diseconomies of scale and an insufficient dynamism to the interchange across sectors necessary for it to be an exemplar of the 'ideal of human unity'. The urgency of population growth traces to various factors: (i) survival reasons, to generate effective economies of scale and counter cyclical stagnation in productive sectors, and to develop sufficient densities to activate legal protection under the NTDA or other routes; (ii) socially, to attract a greater diversity of residents, allow for a critical mass across cultures for the experiment of living unity in diversity, (iii) research-wise, to generate sufficient specialization across disciplines, (iv) spatially, to develop representative densities to take on the spatial challenge of spiritual urbanism; (v) politically, to avoid entrenchment and experiment with urban governance mechanisms at reasonable scale, (vi) spiritually, to provide fullness, colour and dynamism to the collective yoga. In one sense, the slow rate of growth is understandable given that Auroville's demographic growth do not trace usually dynamics. It is essential to safeguard the spirit and culture of Auroville, dedicated to the communal realization of the Integral Yoga. As Sri Aurobindo notes:

At a certain stage it might be necessary to follow the age-long device of the separate community, but with a double purpose, first to provide a secure atmosphere, a place and life apart, in which the consciousness of the individual might concentrate on its evolution in surroundings where all was turned and centred towards the one endeavour and, next, when things were ready, to formulate and develop the new life in those surroundings and in this prepared spiritual atmosphere.

However, in this extreme, insularity and slow growth are likely to result in stagnation and *tamas*. The richness of the Auroville experiment depends on a lively dynamism and interchange with the world, an assimilative process that places it as a centre of research and spiritual activity, across all disciplines, many yet without a presence in Auroville – a 'rich mass and diversity of its thousand lines of inner experience ... its intricate truth and dynamic order.'²⁷³ It is this temper of assimilation that Sri Aurobindo outlined as the genius of India's diversity, a guiding light too for Auroville that demands greater numbers than exist today:

... at no time did Indian culture exclude altogether external influences; on the contrary a very great power of selective assimilation, subordination and transformation of external elements was a characteristic of its processes; it protected itself from any considerable or overwhelming invasion, but laid hands on and included whatever struck or impressed it and in the act of inclusion subjected it to a characteristic change

²⁷³ Sri Aurobindo, CWSA, 1997, Vol. 20, 73-4.

which harmonised the new element with the spirit of its own culture. But nowadays any such strong separative aloofness as distinguished the ancient civilisations, is no longer possible; the races of mankind have come too close to each other, are being thrown together in a certain unavoidable life unity. We are confronted with the more difficult problem of living in the full stress of this greater interaction and imposing on its impacts the law of our being.

...

The principle I have affirmed results both from the necessity of our nature and the necessity of things, of life, — fidelity to our own spirit, nature, ideals, the creation of our own characteristic forms in the new age and the new environment, but also a strong and masterful dealing with external influences which need not be and in the nature of the situation cannot be a total rejection; therefore there must be an element of successful assimilation.²⁷⁴

a. Slow or Fast Growth: the Third Elephant

When considering this question of population numbers and slow growth in our interviews – particularly in relation to entry barriers, delays in implementation of development works, including clearing the right of way for the Crown, the drafting of a Detailed Development Plan etc. – we encountered a debate on Auroville’s proposed timescale: whilst some noted that Auroville is a long-term and ambitious project that we should not rush prematurely, because it will take centuries for a new consciousness to manifest and guide activities, others referred to Mother’s urgency to develop the town within a few years and considered progress slow and lethargic. In its polemic form, the issue was put to us as whether Auroville has failed or is a slow miracle in the making. Again, the 2015 Retreat carefully reconciles these polarities:

5	The population of Auroville needs to grow faster towards the planned population of 50,000.	There is no need of population growth. Quality is more important than quantity.	<i>Quality and quantity are not mutually exclusive. Quality without a certain quantity does not fulfill the need of a replicable model. Quantity without quality is not sustainable.</i>
13	Auroville must be completed within a time frame (city and society). If we do not hurry up the outside world will crush Auroville or reduce it to a suburb of Pondicherry.	Auroville must develop at its own pace. Timelines and targets do not work here.	<i>Work with plans that include quality, quantity and time parameters and revalidate these plans periodically.</i>

(Source: Full Report, Auroville Retreat, 2015, Annexure 5, 64, 66)

On this point, Mother referred to varying timescales. We quote below all references we found in the archives:

²⁷⁴ Sri Aurobindo, CWSA, 1997, Vol. 20, 50, 52.

And a stadium that we want to be the most modern and the most perfect possible, with the idea (an idea I've had for a long time) that ... twelve years after 1968 ... we would have the Olympic games.²⁷⁵

I want the whole town to be built within ten years' time.²⁷⁶ [Guigan notes that Mother stresses this to many people and it is also in a Press Release dated 3.10.1967]

It may be a hundred years, a thousand years.²⁷⁷ [Guigan here comments that 'Mother had repeatedly said she wanted Auroville to be built within 10-20 years.'²⁷⁸]

But of course, for the city to be completed, we must allow some twenty years (for everything to be in order, in its place). It's the same with the gardens: all the gardens that are being prepared are for now, but in twenty years, all that will have to be on another scale; then it will have to be something really ... really beautiful.²⁷⁹

[Mother also approves Anger's estimate on population growth:] On completion of each of the construction phases, one can consider that:

a) in 5 years, the city will house 10,000 inhabitants ... b) in 15 years, 20,000 inhabitants, that is 8,000 accommodations c) in 20 years, 50,000 inhabitants, that is 20,000 accommodations d) in 30 years, 100,000 inhabitants, that is 40,000 accommodations.

I am learning that impatience is no way. In 300 years Auroville will be a very nice place²⁸⁰ ... in 200 years it will be a fine place.²⁸¹

To Roger I said, 'We'll see that [proposals to extend Matrimandir] in twenty years!' So that kept him quiet.²⁸²

[Mother refers to] a change in the condition of Earth in a few thousand years.²⁸³

Of course! Of course! I know what I want, I know what I want Auroville to be. But there is a considerable gap ... It is Auroville in a few years' time, many years from now.²⁸⁴

Thus, while Mother referred to varying timescales – she wanted Auroville to be built within 10-30 years, but also noted that in 100-300 years, it will be a fine place – what is clear is a sense of *urgency*. The repeated mention of timescales in the range of 10-30 years (with population numbers gradually reaching 50,000 by that time in Anger's proposal, approved by her) is a clear indication that Mother wanted Auroville to develop *energetically* and *as soon as possible* to hasten the advent of the New Creation.²⁸⁵ Again, the point is not to increase

²⁷⁵ Guigan, 2018, Vol. 1, 106.

²⁷⁶ Guigan, 2018, Vol. 1, 207, fn. 1.

²⁷⁷ Guigan, 2018, Vol. 1, 169.

²⁷⁸ Guigan, 2018, Vol. 1, 192, fn 1.

²⁷⁹ Guigan, 2018, Vol. 2, 15.

²⁸⁰ Guigan, 2018, Vol. 1, 300.

²⁸¹ Guigan, 2018, Vol. 1, 301.

²⁸² Guigan, 2018, Vol. 2, 32.

²⁸³ Guigan, 2018, Vol. 1, 73.

²⁸⁴ Guigan, 2018, Vol. 2, 132.

²⁸⁵ Sri Aurobindo's call to action in this aphorism is a helpful guide: 'Work as if the ideal had to be fulfilled swiftly & in thy lifetime ...' Sri Aurobindo, CWSA, 1997, Vol. 12, 464.

population numbers or build materially for the sake of it, but to do so in line with the spiritual ideal. As Denino notes, quoting Mother, the process is as important as the result:

It's not when Auroville is ready – when Auroville is ready, it will be one town among all other towns and it's only its own capacity of truth that will have power ...²⁸⁶

Yet, the urgency of the spiritual vision – the ‘rush of the car of the Time-Spirit in the extreme velocity of its progress’ – is writ large in her *Agenda*.²⁸⁷ As is the call to action in Sri Aurobindo's ‘Hour of God’:

Unhappy is the man or the nation which, when the divine moment arrives, is found sleeping or unprepared to use it, because the lamp has not been kept trimmed for the welcome and the ears are sealed to the call. But thrice woe to them who are strong and ready, yet waste the force or misuse the moment; for them is irreparable loss or a great destruction.

However, as we saw in Part III.A, several projects approved by the Mother and those envisaged in the Perspective Masterplan and a raft of planning documents since – a population of 15,000 by the end of Phase I in 2010, and 50,000 by 2025, along with development works – have been delayed. It would be unhelpful to impose artificial deadlines, given that a project of the scale and ambition of Auroville is subject to vagaries and adverse forces. The figure of 10-30 years may not be a strict deadline, but is nonetheless representative of the time range contemplated at the time. In comparison, the rough average of the population growth rate from 1972-2019 is a low number of 50 new residents per year, at which rate it would take 945 years to reach 50,000 residents. By any measure, Auroville's growth in population and development terms was anticipated by Mother to be an order of magnitude faster than it has been.

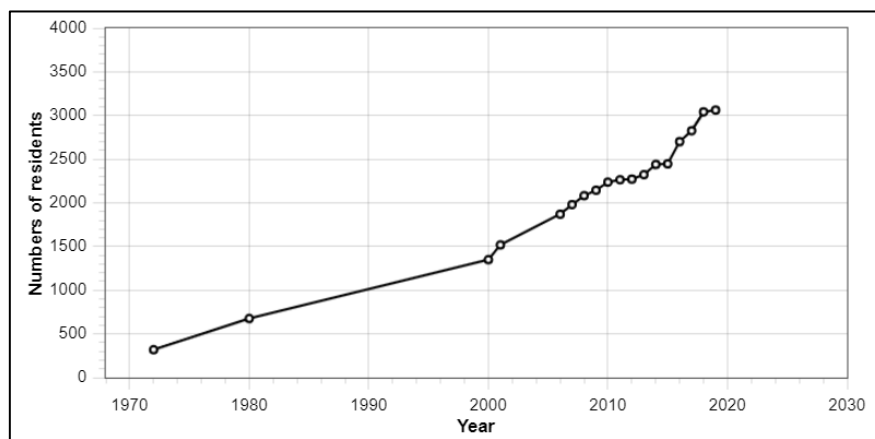

(Population growth rate, 1972-2019. *Source*: population figures taken from the Masterplan, para. 1.6.4; Suhasini et. al., 2.)

Here too, various well-prepared plans, projections and attempts to increase population numbers in reasonable increments have not come to fruition.²⁸⁸ As the records show and several

²⁸⁶ Danino, 2022, 2; Guigan, 2018, Vol. 1, 170. It is in this context that the recent use of force by residents and the police was a singularly unfortunate incident, just as reported instances of thuggery and threats during the conflict with the Sri Aurobindo Society. *See*, for example, Mukherjee, 2019.

²⁸⁷ Sri Aurobindo, CWSA, 1997, Vol. 25, 488.

²⁸⁸ *See*, Part III.A.

conversants noted, there has been a marked waning of the sense of collective urgency in key sectors, with at times active resistance to growth, leading to fatigue and frustrated retreats by individual residents from the collective process. In the 2015 Retreat, Dr. Singh, as Chairman of the Governing Board, bluntly noted that it is the time now for a ‘breakthrough or a breakdown’.²⁸⁹ Four years later, he sounded a warning bell with this realistic remark:

Auroville today hosts a population of a little over 2844 residents from 58 nations, which is a far cry from the township of 50,000 residents that the Mother had visualized ... Even after five decades of its founding, Auroville is still in the project stage ... There is no gainsaying that without active support and cooperation of all ... Auroville *may not be able to* ultimately become the focal point of a worldwide movement for human unity.²⁹⁰

Notably, Mother portended the consequences of such a delay:

No compromises, no half measures, no ‘It will come later.’ Just like this (Mother brings down her fist): a dreadful Will. And that’s the only way for things to go fast.²⁹¹

In this context, we may adapt Sri Aurobindo’s articulation of the four aids to practice in the *Synthesis of Yoga*: while the instrumentality of time (*kāla*) will take its due and is outside our hands, *utsāha* (the force of personal effort) and *vyākultā* (the heart’s eagerness) are within our hands. They translate, in the practical context of city-building, to the best available action for organization of the collective and urgent manifestation of the vision *today*, drawn from the ‘highest summit of our consciousness’ at present, albeit imperfect:

The ideal attitude of the sadhaka towards Time is to have an endless patience as if he had all eternity for his fulfilment and yet to develop the energy that shall realise now and with an ever-increasing mastery and pressure of rapidity till it reaches the miraculous instantaneousness of the supreme divine Transformation.²⁹²

Auroville’s development must be careful, considered *and* urgent. The intensity of aspiration is central and an *a priori* concession that it will take decades or centuries is self-defeating and possibly a disguise for *tamas*, even if it ultimately takes that long. Sri Aurobindo puts it in an aphorism in this way:

Fix not the time and the way in which the ideal shall be fulfilled. Work and leave time and way to God all-knowing.²⁹³

We may also note here that the development of Auroville to 50,000 residents is not an end point – it is one that will continually create and recreate itself with time and entry of new residents, and indeed, as a distant hope, paving the way for other ‘Aurovilles’. The goal is therefore not static, but one for ‘eternal progress’:

We would like Auroville to be a progressive, an evolving town, full of meaning, never to be ‘finished’. This continual growth does not refer to the number of inhabitants,

²⁸⁹ We did not find this mention in the records. It was confirmed in several interviews by those who participated at the Retreat.

²⁹⁰ Auroville Foundation Annual Report, 2018-19, 6 (emphasis ours).

²⁹¹ Guigan, 2018, Vol. 2, 326 (emphasis ours).

²⁹² Sri Aurobindo, CWSA, 1997, Vols. 22-23, 68, 53-58.

²⁹³ Sri Aurobindo, CWSA, 1997, Vol. 12, 464.

which will not exceed fifty thousand, but to an evolution of the physical body, of the life of Auroville, of its society and also of its genius ... Above fifty thousand, new Aurovilles will start being built, let us hope, for Auroville is being devised to help solve community living problems all over the world.²⁹⁴

b. Strategic Outreach

There are naturally significant and real dangers to be guarded against in this movement to secure an urgency of action – developing material infrastructure is necessary for the manifestation of the ‘city’, but the danger that it may invite a commodification of Auroville is real, translating it into a showcase as a centre for ‘spiritual tourism’ or more broadly, an instrumentalization of its true and deeper purpose for immediate ends.²⁹⁵ This concern is weighty, particularly as the now hospitable terrain developed through years of work offers a comfortable living. Indeed, Mother had signaled this concern at the founding, albeit in a different context: ‘it is not for comfort ... that one comes to Auroville; it is for the growth of consciousness and consecration to the Truth that has to be realized.’²⁹⁶

Accordingly, Auroville’s growth and expansion, in terms of population numbers, infrastructure and capital must be guided by the following counsel, avoiding both insularity and a ‘handing over’, both assertions of egoistic ownership inapt for Auroville:

I know it’s not easy, but we are not here to do easy things; the whole world is there for those who like an easy life. I would like people to feel that coming to Auroville does not mean coming to an easy life – it means coming to a gigantic effort for progress. And those who don’t want to keep up with it should leave. That’s how things stand. I wish it were so strong – the need for progress, for the divinization of the being, so intense – that those who are unable (unable or unwilling) to adjust to it would leave by themselves: ‘Oh, this is not what I expected.’ As it is now, all those who want an easy and to do what they please as they please, say, ‘Let’s go to Auroville!’ It should be just the opposite. People should know that coming to Auroville means an almost superhuman effort for progress.

It is the sincerity of our attitude and effort which makes a difference. People should feel that insincerity and falsehood have no place here — they just don’t work, you can’t fool people ‘who have devoted their entire life to go beyond humanity.

There is only one way to be convincing — it is to BE that.

Then we’ll stand strong, we’ll have all the divine force on our side.²⁹⁷

Safeguarding the true purpose of Auroville, to progressively realize the Divine in a terrestrial and collective effort, in life and in the daily rhythms of communal action demands an intense aspiration, in a safeguarded and stewarded public culture, one that is based on the purity of sincere inner seeking, not outward displays of piety. This demands free play, variation and above all, a space to express and experiment. While strategic outreach and bold action to build the material and cultural infrastructure is important, unchecked publicity to attract talent and

²⁹⁴ Anger, ‘=1’, 1968.

²⁹⁵ Banjerji’s cautionary note is important. Auroville Today, September, 2023.

²⁹⁶ Guigan, 2018, Vol. 1, 300.

²⁹⁷ Guigan, 2018, Vol. 2, 362.

capital is dangerous. Care must especially be had to avoid standard and homogenous expressions of public piety that are untied an inner movement. In the beginning, middle and end, the inner purpose of Auroville – ‘the growth of the flame’ – alone matters. Outer publicity or showcasing is useful, but incidental to the true purpose. Writing in 1920 to his brother, Sri Aurobindo laid out the one thing that he wanted:

I wish to make a large and strong equanimity the foundation of the yoga. I want established on that equality a full, firm and undisturbed Shakti in the system and in all its movements. I want the wide display of the light of Knowledge in the ocean of Shakti. And I want in that luminous vastness the tranquil ecstasy of infinite Love, Delight and Oneness. I do not want hundreds of thousands of disciples. It will be enough if I can get a hundred complete men, purified of petty egoism, who will be the instruments of God. I have no faith in the customary trade of the guru. I do not wish to be a guru. If anybody wakes and manifests from within his slumbering godhead and gets the divine life – be it at my touch or at another’s – this is what I want. It is such men that will raise the country.²⁹⁸

In 2015, the International Advisory Council recognized the distinctiveness of Auroville’s mission, yet noted that ‘certain ... crucial factors [are] affecting the further evolution of Auroville as a unique model of human endeavour within a sustainable, spiritual and collective framework’. These factors included the ‘population and resident projection deficit, spreading and widening of the message and the mission, sharing and showcasing the unique achievements of Auroville with the wider global community, and creating more open, effective and cohesive channels of internal and external communication.’²⁹⁹ Accordingly, it is imperative for Auroville today to engage in sensitive and targeted outreach to expand numbers – our proposed restructure above assigns the lead in this task to the Working Committee, dedicated exclusively to external liaison, partnership development and media outreach.

The ideal of Auroville – for a materially simple and comfortable life in a beautiful and green urban environment, to focus on tertiary research activity in a cosmopolitan setting, dedicated to the life-affirming practice of the yoga – is deeply enticing to the progressive youth of India and the world. It is safe to say that far more than fifty aligned and dedicated individuals, the current growth rate, can be welcomed with the correct outreach and investment. Targeted and proactive measures are thus both necessary and pressing, to counteract institutional inertia, or in some cases, resistance to growth:

- i. Population profile projections for the next five and ten years, specified across zones and the nature of activity, developed in line with Auroville’s research aspiration in each sector.
- ii. ‘Strategic outreach plans’, with identified partnerships, inducements etc., may be developed across Working Groups along these lines to attract talent. Given time and

²⁹⁸ Banerji’s cautionary note, guarding against both insularity and a ‘handing over of Auroville’, is pertinent here. Ownership ultimately rests not with any human entity, but with the Divine – his timely counsel is thus all-important: ‘But perhaps the most powerful thing that can be done at this time is to gather oneself, intensify one’s aspiration and call to the Mother ...’ *See*, Auroville Today, September, 2023.

²⁹⁹ Guigan, 2918, Vol. 1, 27-8.

capacity constraints, we suggest a dedicated platform to pursue external outreach and anchor engagements in the form of a single-window channel in the Working Committee that may assist Working Groups to develop a positive footprint in India and globally. Our proposed institutional template in Section D above focusses all external-facing activity in the Working Committee, to streamline these efforts and relieve it of its current, and inefficient, patchwork of duties across sectors.

- iii. Investments in catalytic sectors – which we discuss sectorally in Part III – to develop cluster dynamics and enhance research / innovation infrastructure and newcomer housing capacity;
- iv. As we have detailed sectorally in Part III, research-driven outreach to high-skill centres, aligned institutions, universities, industries, with fellowships, in-residence programmes, exchanges etc. may help attract aligned talent and capital. This will allow Auroville to avoid unhealthy publicity, yet draw on the gatekeeping mechanisms of these institutions as a means to secure targeted outreach.
- v. Termly / yearly review by the Unity Committee and Steering Group to allow for cross-sectoral coordination and synergy, and to ensure accountability as against the proposed strategic outreach plans.

The inertia and entrenchment concerns in various sectors that have impeded growth require a fresh impetus along these lines. The world needs to know Auroville as a hub of research and life-affirming spiritual activity, not a remote destination in south India.

ii. Exit Mechanisms

The opposite issue – of exit mechanisms – is equally important, to safeguard Auroville’s spiritual aspiration and public culture. To the best of our understanding, the Termination Committee established under the Rule 5 of the Auroville Foundation (Admission and Termination of Persons in the Register of Residents) Regulations, 2020 has not been constituted (‘Termination Regulations’).³⁰⁰ The Termination Regulations constitute a committee of nine members, six of whom have been resident in Auroville for more than five years, appointed for a term of three years, with a yearly rotation of one third of the membership, presumably to avoid entrenchment. Rule 7 details the powers of the committee, which include the power to reject a termination request (raised by the Working Committee or from at least sixty residents), issue a public warning or censure, issue orders for a resident to leave Auroville permanently or for a period of time and recommend a removal of a residents’ name from the register.

The gate-keeping function, to determine entries and exists, is vested exclusively in the Residents’ Assembly under Section 19(2)(a) of the AVF Act, 1988, to be conducted in accordance with regulations made under Section 32, which concerns the power of the Governing Board to make regulations. Facially, as we discuss in Part V, there is a distribution

³⁰⁰ We did not have the benefit of studying the draft ‘Internal Exit Policy’ developed by the Exit Policy Task Force. We were also informed that a new policy was being drafted as of April, 2023. Our comments may accordingly be subject to further study.

of powers between the Governing Board, to make regulations (with the advice of the Residents' Assembly) and the Residents' Assembly, to determine whether a resident is to be admitted or terminated in accordance with those regulations. Naturally, as in any collective, one devoted to the practice of the yoga no less, this gatekeeping power is reserved for the collective itself.³⁰¹ Six points may be made in this context.

First, the power to terminate residents, either directly or indirectly by withdrawing a visa recommendation for non-Indian residents, is to be exercised sparingly and judiciously. As we discuss below, the space and freedom to experiment and express, including a wide margin for dissent and disagreement, is key. Accordingly, the power to terminate must be carefully circumscribed to avoid a chilling effect, reserved for instances that clearly breach the core of tenets of Auroville – law and order, intimidation, harassment, prolonged and unexplained absence (for which a clear 'cut-off' date is required, with a clause for exceptional cases in the discretion of the Termination Committee), fraud, financial integrity concerns, wilful and persistent non-compliance of due process, demonstrated and persistent resistance to contribute by work etc. – and not the sway of majority or minority opinions of the day. This will require the formulation of precise policy specifications.

Second, Mother's views on this issue are instructive – she recognized the need for a wise and firm authority vested in a small group, the Entry Board and the Termination Committee in today's context, to ask those 'on trial' to leave, yet cautioned restraint in relation to those who have been in Auroville for a settled period of time. In the ideal, however, she insisted that it would be the strength of the atmosphere that would automatically exert a pressure on those non-aligned (how one measures this being the critical point) to leave of their own volition:

Something could be organised with the people we can trust, and if the others are dissatisfied, they can leave. Do you understand what I mean? Instead of taking an active position of 'Go away' (which for many reasons is very difficult), if we put them under an authority they don't accept, they will be forced to leave. They will protest at first, but we must remain firm: 'This is how it is. We must find the people capable of doing this, with the required strength of character, and once we find them, they can be given the authority, and if the others don't like it, they'll have to leave! And that's that. But we can't dismiss people who are already there as long as we don't have the person or persons capable of actively assuming that position.

[R.: Yes, Mother, it's clear. But there's also the problem of admissions to Auroville ... For instance, certain elements seem absolutely undesirable to us from the start. And yet these people are sometimes accepted. Is there a reason for this?]

On trial. Only on a trial basis, never otherwise.

³⁰¹ Interestingly, in the debate in the Lok Sabha during the passage of the AVF Act, 1988, a suggestion was made by a member that: 'There should be an institution which may exercise control over the Resident Assembly ... to prevent the undesirable persons, whose stay in India are not in the country's interest, from staying there as their stay may not liked by the Government of India and the community there. There should be some sort of a body which may look into such cases. The body will decide the suitability of persons who could be granted permission to stay there ... It is, therefore, necessary that the Government should be very cautious with regard to selection of persons to be recognised by the Residents Assembly. A monitoring body or some controlling agency must be there to regularise such activities.' This suggestion was not incorporated in the legislation. Lok Sabha Debates, 1988, 489-90. For the Minister's response, *see*, 94-95.

[R.: But, Mother, once they're here on trial, nobody can ever send them away!

Ah, no! If they are not satisfactory, they can be sent away. I was only speaking of those (this is in fact what I was saying to Shyam Sunder), whom I was forced to remove from the Ashram because they were totally undesirable in the Ashram, and they went to Auroville; these people should either go, or else feel... as I said, feel that they have no place here. But the newcomers, those who are accepted on a trial basis and who turn out to be undesirable, can be sent away. I meant the old-timers, those who have been here for years and years. But the newcomers, all those who have been taken on trial and are not satisfactory, they can leave – they MUST leave. I give you full (Mother points to Roger and Shyam Sunder) authority to send them away ... There should be one person – one or two (two is very good) – to present the admissions to me, the new admissions to Auroville, and I fully agree to send back those you (Mother points to Roger and Shyam Sunder) find undesirable.

...

You must give them at least one month. At least one month. But if they show the slightest insincerity, you understand, if they say, 'I don't do this, I do that, I won't do this, etc.,' just tell them, 'You can leave.' You don't even need to ask me, you can just send them away. Simply inform me: such and such person has been found unsatisfactory. I give you the authority to do it. I won't protest.³⁰²

Importantly, in response to Anger's perceptive question, Mother noted that Auroville must be open, yet not invite difficulties – thus placing a great responsibility on the Entry Board, as of today, to safeguard the entry mechanisms, and on the Working Committee, as the body charged with outreach in our proposed, to impress upon all that coming to Auroville 'does not mean coming to an easy life', but to 'a gigantic effort for progress'. As always, this is a matter ultimately determined by the strength and pressure of the collective consciousness, of which the Working Groups are a reflection:

[R.: The question in our minds, Mother, was to know whether you saw these people as being useful in providing Auroville with a certain type of difficulty.]

No! Certainly not! No, no, I don't favour deliberately adding difficulties! I know they come for... But they shouldn't be invited – on the contrary. They shouldn't. Things should be made as easy as possible. Only, we shouldn't be ruffled by difficulty, that's the point. I am not at all saying that difficulties should be accepted – don't invite them at all, at all, at all; life is difficult enough as it is! But when a difficulty comes, you must take heart and face it courageously. I know it's not easy, but we are not here to do easy things; the whole world is there for those who like an easy life. I would like people to feel that coming to Auroville does not mean coming to an easy life – it means coming to a gigantic effort for progress. And those who don't want to keep up with it should leave. That's how things stand. I wish it were so strong – the need for progress, for the divinisation of the being, so intense – that those who are unable (unable or unwilling) to adjust to it would leave by themselves: 'Oh, this is not what I expected.'

³⁰² Guigan, 2018, Vol. 2, 356-361.

As it is now, all those who want an easy life and to do what they please as they please, say, ‘Let’s go to Auroville!’ It should be just the opposite. People should know that coming to Auroville means an almost superhuman effort for progress.³⁰³

Third, in the early years, with Mother’s authoritative presence, entries and exits could be determined by her guidance and vision; yet the infallibility of residents, even of the wise sitting in committee, naturally presents reasons to be careful in an exercise of this power. The power of the Termination Committee under the 2020 Regulations, or any other body vested with this power, must therefore be carefully circumscribed and transparently exercised with publicly stated reasons, within a system of checks and balances. A judicious self-restraint is necessary for the proper exercise of this power, for which reason the Committee must comprise the experienced and wise of the community. The constitution of the Termination Committee has, to the best of our understanding, not yet been finalized after the 2020 Regulations: in our proposal, this may be the Council of the Wise / Unity Committee / Steering Group, as deemed appropriate, with a requirement for consensus, so as to err on the side of caution and safeguard the necessary freedoms required for residents to freely express themselves, particularly when their opinion is unpopular. There is a long-standing literature on the need for strong safeguard for the freedom of speech and expression for a vital public life, key to Auroville, with a debate on where one may draw a line for reasonable limitations to that freedom: Auroville may draw on this literature in its policy design.³⁰⁴

Fourth, the 2020 Regulations currently require the Termination Committee to ‘recommend’ removal to the Working Committee, with the Secretary to the Foundation, reporting to the Governing Board, ultimately charged with the maintenance of the register of residents. The distribution of roles and methods of resolve potential disagreements in this chain are unclear. Facially, it appears from a reading of the Regulations that the Termination Committee – whether constituted independently, or through the bodies we propose – has the primary responsibility in this matter. The role of the Working Committee is unclear, as of the Secretary, who draws powers from the Governing Board.³⁰⁵ Yet, reading the Regulations in context, we suggest that the primary duty of the Committee be explicitly stated to avoid parallel processes, yet with one layer of review, given the nature of the power. Under the Regulations, this would mean that the Working Committee too must agree with the recommendation, placing a requirement of dual concurrence. In our proposed setup, which would ideally require an amendment to the Regulations to make matters explicit, but may be operated within its current formulation as well, the second layer may vest with the Steering Group. As it is commonly constituted between the three statutory bodies, nominees of each may participate in this key decision. Section 19(2)(a) lists termination as within the exclusive powers of the Residents’ Assembly, in which

³⁰³ Guigan, 2018, Vol. 2, 356-361.

³⁰⁴ Stone and Schauer, *in* Stone and Schauer (eds.), 2021.

³⁰⁵ This point has been raised previously, and remains unresolved. *See*, Auroville Today, June-July, 2013, 4. (‘The second problematic aspect is that though the Regulations mention that the Review Committee may take the decision that a person has to leave Auroville, it also mentions that the Review Committee will recommend to the Working Committee that a name be removed from the Register. The Working Committee, in turn, makes a recommendation to the Secretary, who maintains the Register of Residents. Here a potential conflict may arise as the Regulations do not specify what is to happen if the Working Committee disagrees with the decision of the Review Committee.’)

case on may read the text strictly such that the role of the Governing Board is limited to developing the policy under Section 32 on the advice of the Residents' Assembly and of the Secretary as updating the register of residents in accordance with the decision of the Termination and Working Committees. Yet, the practice of mutuality would ideally require that the first level of decision be made by a resident-body, and the second layer of review, allow all three bodies to weigh in for a final decision. In this way, any conflict resulting from a disagreement between the Governing Board / Secretary and Residents' Assembly may be helpfully avoided.

Fifth, outside of the power of termination, it is important as a general matter for Auroville to develop reasonable and fair exit options for residents who wish to leave in good faith, voluntarily for personal reasons. This is so in terms of housing assets and commercial units to which the residents have contributed effort and funds. Assets are not privately owned, such that one can claim a right to compensation or restitution. Yet for those who desire to leave the collective after having served for a settled period of time, these mechanisms may operate as an expression of goodwill and mutual trust. This is particularly as the inner offering to the Divine is not the same as a 'legal offering' to a public authority, a point of reasonable concern that acts as an entry barrier for newcomers and may be allayed by this measure. The pull towards Auroville must as far as possible remain voluntary, supported by the strength of its culture, and not a legal bond.

Finally, in general, Sri Aurobindo and Mother preferred 'spiritual compulsion' – the guiding and proscriptive force of the spiritual culture – to rule enforcement insofar as the regulation of exits and unbecoming behaviour is concerned. It is ultimately the strength and vibrance of Auroville's atmosphere, nurtured in the collective, that will determine entries and exits, with rule enforcement a last, and in the ideal, unnecessary, resort. The Entry Board and Termination Committee are then the sharp edges, whilst the strength of the public sphere is the primarily regulator, such that *work* in the community in the newcomer process and after exerts a pressure to align or exit. Given the persistence of these debates in our interviews, we reflect on this issue presently.

iii. Rule Enforcement and Spiritual Compulsion

Several conversants during our research pointed to instances of behaviour not in keeping with the ideals of Auroville. A common complaint was that as there is no collective enforcement mechanism, liberty translates to license. While we cannot comment on specific instances, this was a constant refrain during our interviews and it is as such an important question. We address it briefly here to suggest that strategic investments in developing a *public* sphere (a term that requires careful definition) are critical to foster a *collective* culture of spiritual living (more than an aggregate of private spaces, with loosely connected individuals or groups happening to come together on issues), that can progressively diminish the need for rule enforcement vis-à-vis licentious activity.

a. Neutrality and Value Pluralism

This issue is vital for Auroville today – it reflects a long-held concern in political thinking, which requires Aurovilians to arbitrate between the competing claims to freedom and public

culture. The question is how Auroville should build and safeguard its public culture, whether by force, i.e. enforcement of rules, or otherwise. It also animated several of Mother's discussions in the *Agenda*, when faced with indiscipline, use of drugs, refusal to work or collaborate, resisting progress for comfort, mistaking spiritual freedom for license and desire, rejecting her authority and so on, all concerns raised in our interviews.³⁰⁶ For this, we revisit Mother's words, read along with Sri Aurobindo's suggestion that 'spiritual compulsion' can substitute the need for rule enforcement. Alongside, we weave in allied discussions in literature elsewhere, to point to valuable areas of future research. We suggest that while there are dangers of imposing one's views on others in the name of solidarity, there are equally dangers to the 'live and let live' picture that exerts no pressure on licentious activity in the name of individual freedom. Auroville's public culture will need to navigate the fertile terrain between them. On one hand, it will have to guard against the imposition of singular moral standards (value monism) in a paternalist setup, given that Auroville must nurture a healthy plurality of moral conceptions (value pluralism). On the other, this does not mean that everything goes. Auroville's public culture must devise ways to preserve a vast freedom, including the freedom to experiment and err, whilst building spiritually sensitive forms of life, backed by a strong value system in micro-environments, schools, workplaces, restaurants, public meetings, neighbourhoods etc. that strongly deter and discourage patterns of behaviour not in keeping with the ideals. This has vital consequences in relation to governance reform and the viability of formal institutional systems like the Residents' Assembly, Working Groups, which we discussed above. We offer some brief reflections here on its connection to rule-enforcement and the acculturation of an 'Auroville identity'. Three points can be made in this regard:

First, we note Mother's inexhaustible loving patience when faced with examples of indiscriminating behaviour. This anti-paternalist tact was a pedagogical tool born of the idea that errors lead to learning, (painful) growth and self-correction ('I make even sin and error stepping-stones / And all experience a long march towards Light.') Naturally, the negative conception of freedom – to be subject to no external authority, a characteristic of the age of reason in Sri Aurobindo's formulation – must be respected in Auroville; yet this must be so within a thick, facilitative and guiding culture that pushes towards a more positive orientation of that freedom. As we discuss later, it is this public culture, to be nurtured and fostered (as several individuals and collectives we had the opportunity to visit in our research do with great and loving care), that will perform the gatekeeping function of determining entries and exits of newcomers and Aurovilians.

Second, the question of individual freedom and collective culture has been debated and developed in practical contexts in great detail in other traditions of thinking, with which one can dialogue. For example, the influential philosopher Joseph Raz notes – dovetailing with Sri Aurobindo and Mother's thought at various points – that:

At the intuitive level anti-perfectionism [the idea that we should remain agnostic to and not impose our moral views on other, equally free beings, unless their actions directly 'harm' us] responds to a widespread distrust of concentrated power and of bureaucracies [a view often expressed in our interviews]. The best intentions and the

³⁰⁶ See, for example, Guigan, 2018, Vol. 2, 354-5.

wisest council are likely to misfire if entrusted to the care of the machinery of state action. Beyond that there is the deep-felt conviction that it is not within the rights of any person to use the machinery of state in order to force his conception of the good life on other adult persons.³⁰⁷

This state of being ‘value blind’ – remaining neutral or turning a blind eye to actions, behaviours and forms of life that are ethically and spiritually unbecoming of Auroville’s ideal culture (howsoever one defines that term) – is, for Raz, a hazardous route to take, even if driven by an understandable fear of excessive imposition and fallibility.³⁰⁸ If sufficiently diffused, it risks leading to individual bubbles of self-authenticating existence, and dents away at the public culture and breaks collective solidarity. This is, as we saw in Part III, a fault-line in Auroville’s current organization.

Instead, we can be value-plural, accepting several, but not all, forms of life as valuable. The ‘live-and-let-live picture’, common to popular understanding, is only half the picture. We must ‘live-and-let-live-together’ in common pursuit of the spiritual good. In this, we want as a practical matter, collective institutions, groups and spaces to positively help us achieve our goals, and to push us to pursue good ideals instead of bad ones, for which a cultivated plurality, rather than blindness, is the appropriate antidote. Put otherwise, this means that as Raz notes, the community need *not* support or permit actions contrary to its ideals in the name of liberty (*‘but it’s my life and that’s how I want to live’* etc.), unless – as Mother does – we have good reasons to say that the mistakes fortify our liberty in turn, as part of our learning process.³⁰⁹

This approach carries real risks. We may end up imposing our views on others, leading to a minority or majority capture of the public space, considering our partial moralities as infallible (a caution Sri Aurobindo and Mother sound in no uncertain terms).³¹⁰ This is the historically common pitfall of mistaking unity for uniformity, the potent strain of arguments against community regulation of morals in favour of individual freedom. Yet it is a journey that cannot be avoided: ‘the general effect of the risk of failure cannot lead to anti-perfectionism.’³¹¹ The risk of this excess in Auroville is particularly relevant (i) given Mother’s dream that Auroville will be ‘at last a place where nothing will have the right to impose itself as the exclusive truth’ and (ii) the uniquely international and diverse social fabric of Auroville that places conflicting moral views in close quarters.

As we outline below, it is here that a public culture devoted to the practice of the Integral Yoga can proactively cultivate plurality, foster a thriving marketplace of ideas which can nurture a progressive widening of individual conceptions and avoid concentrations of power in any single idea-force, thus preserving Auroville as a place where no exclusive truth installs itself to the throne. The means to nurturing liberal in a collective is not through neutrality but plurality. Yet, in this space, hard choices will have to be made in Auroville on ideas or forms of life that

³⁰⁷ Raz, 1986, 111 (inline comments ours).

³⁰⁸ See, for a useful discussion on the pitfalls of the idea of remaining neutral, Taylor, 1985, Vol. 2, Ch. 2.

³⁰⁹ For a detailed discussion on this point, arbitrating between paternalism and the ‘harm principle’ (that behaviour should only be regulated if it harms another, and not on grounds of perceived moral wrongness by others or self-harm), including examples of soft and hard forms of regulation, see Feinberg, 1987-90.

³¹⁰ See, for example, Berlin, 2002.

³¹¹ Raz, 1986, 160.

ought to be discouraged or not tolerated, aided by the sobriety of dispassionate thinking, available inspirations and faith, assisted by a voluntary submission to the wise in the community, within the highest traditions of Auroville's diverse public culture. Boundary drawing and signalling, through soft and hard modes of enforcement, is a necessary part of developing a positive public sphere: as Mother noted bluntly, we often 'need something to straighten [us] out.'³¹²

This interplay between the communal and the individual domains – tackling the problem of our 'social unsociability' in Kant's apt formulation – is what defines *in practice* Auroville's ideal of the collective yoga. Mother's view of liberty, adapting Berlin's famous articulation, is not only a negative matter (freedom *from* authority, from others), but also a positive one (freedom *to* achieve with others).³¹³ It is not only an individual matter, but a communal one. Mother signalled this collective pursuit of freedom as a defining feature: 'by the very nature of things, it is a collective ideal that calls for a collective effort so that it may be realised in terms of an integral human perfection.' Thus, as Raz argues *contra* value-blindness, we must generate a public sphere that debates and affirms a plurality of valuable conceptions of the good, and does not leave it entirely to the private or individual domain as a matter to be decided at the whims of preference. We can and must come down then (though not in force, exceptional cases aside) against invaluable ideals. Looking the other way, or sliding inconvenient truths under the carpet, dents the integrity of public culture. It risks – as many have noted – turning Auroville into a series of loosely related, semi-autarchic settlements without cohesion.³¹⁴ Instead of sober, informed and mutually responsive issue-based debates conducted in a spirit of deep listening and dialogue, we may (and did, in some conversations in our research) witness generalized labels, uninformed othering, entrenched positions within groups and echo chambers.

Third, as a practical matter, rule enforcement ought to be minimal to instances that clearly breach basic tenets of Auroville, but beyond that it is the strength, vibrancy and diversity of collective fora and community dialogue initiatives in public spaces (which some conversants noted were absent, leading to echo chambers) that will compel change from patterns of unbecoming behaviour. This living force of the public culture is what Sri Aurobindo calls 'spiritual compulsion.' In an important passage that encapsulates our discussion till now, Sri Aurobindo arbitrates between the enforcement of external rules and spiritual compulsion in this way:

Its [a spiritual society] aim will be to diminish as soon and *as far as possible* ['progressively, in lock step with inner development'] the need of the element of external compulsion in human life by awakening the inner divine compulsion of the spirit within and all the preliminary means it will use will have that for its aim. In the end it will employ chiefly if not solely the spiritual compulsion which even the spiritual individual can exercise on those around him, — and how much more should a spiritual society be able to do it, — that which awakens within us in spite of all

³¹² Guigan, 2018, Vol. 2, 234.

³¹³ Berlin, 2002.

³¹⁴ Shinn, 1984.

inner resistance and outer denial the compulsion of the Light, the desire and the power to grow through one's own nature into the Divine.

For the perfectly spiritualised society will be one in which, as is dreamed by the spiritual anarchist, all men will be deeply free, and it will be so because the preliminary condition will have been satisfied. In that state each man will be not a law to himself [‘the live-and-let-live picture’], but the law, the divine Law ... Nor will that mean a breaking up of all human society into the isolated action of individuals. [‘individual bubbles of self-authenticating existence’].³¹⁵

b. Code of Conduct

In this context, some conversants noted the need for a code of conduct for Auroville residents to abide by.³¹⁶ A similar proposal has been discussed by the Governing Board.³¹⁷ This is valuable and needed, if internal self-regulation is missing. Drafting such a code will naturally raise practical problems. If the code is worded generally as an exhortation to abide by Mother's ideals, it may guide and signal the core values of Auroville yet may not have sufficient precision or teeth to deal effectively with particular instances of unbecoming behaviour. If the code is worded specifically, in relation to particular forms of behaviour, it can (and must) set clear standards for basic norms (drug use, violence, intimidation, financial integrity in running units, transparency, long-term absence without sufficient reasons, independent sources of income etc.) but will have to tread carefully beyond to avoid limiting the scope of freedom required for exploration, growth and dissent. This will require sensitive drafting to set basic norms to guide, with a careful deployment of hard and soft modes of enforcement, and without placing undue constraints. Moreover, as with any prescriptive document of its kind, interpretive ambiguities are unavoidable, which will present downstream issues to consider. A detailed examination on the contents of such a code is important, but outside our scope here.

At any rate, however, ‘external compulsion’ by a code of conduct is best substituted, in Sri Aurobindo's ideal, by a public culture of ‘spiritual compulsion’, for practical as much as moral reasons. Rule-based enforcement machineries have an important place in regulating unbecoming behaviour and can assist in signalling what is expected of residents, but one would ideally hope that Auroville travels beyond them. That they become as far as possible unnecessary, in Mother's understanding. Practically speaking, this spiritual compulsion is represented in the moral and spiritual tenor of micro-level interactions and activities that constrain, guide and assist in ways that are likely to be far more effective than any external code. This link between rule-based and self / customary regulation is a well-researched area: a web of customary norms and usages, developed incrementally at the micro-level, are more likely to engender support, adapt to variations in individual circumstance and exert a stronger influence on participants than rule prescriptions, with the latter shoring up accountability deficits.³¹⁸ Auroville's governance choices on the appropriate balance between internal /

³¹⁵ Sri Aurobindo, CWSA, 1997, Vol. 25, 259 (emphasis and inline comments ours.)

³¹⁶ This is in addition to the existing Code of Conduct for Trusts and Units. *See*, FAMC, Code of Conduct, 2017.

³¹⁷ Minutes of the 61st Meeting of the Governing Board, Auroville Foundation, 2022, 18.

³¹⁸ *See*, for example, Papenfuß and Schmidt, 2022. This is also a long-standing debate in the common law tradition, an interesting if niche area for research in Auroville for its regulatory, ‘legal’, design, for which *see*, Allan, 1994, 79-108.

customary regulation (rising to spiritual compulsion) and rule-enforcement through codes of conduct will thus require careful attention to this dynamic.

iv. *Stewarding Public Culture*

Developing this ideal customary system of spiritual compulsion shifts emphasis to spaces such as schools, youth forums, workplaces, restaurants, cafes, shops, cinemas, theatres, community centres like the Solar Kitchen, public libraries, museums, gardens, neighbourhood and playground gatherings, study and research groups, care centres and hospitals. Equally, it should inform the tenor of discussions in public meetings in the Town Hall, the Residents' Assembly and various Working Groups, zonal and ward-level meetings and community interactions, the work of the art, sport and other services, collective planning exercises like the Dreamweaving workshops, AuroNet, newsletters (*News and Notes*, *Auroville Today*), journals and magazines (*Ritam*, *Collaboration*, both now discontinued we are informed), professional gatherings, valuable educational initiatives like the Auroville Campus Initiative, Aware Auroville, Youth Link, public talks, seminars, debates, events in the Cultural and International Zones and others too numerous to list. The social dynamics of *these* micro-spaces will *cumulatively* generate norms to constrain and regulate behaviour; they will add up to build a self-conscious culture that furthers spiritual growth, and places pressure on those not aligned with the ideal to reform, 'simply by the richness of its atmosphere' (with Matrimandir being the exemplar).

The vitality of Auroville's city-life can thus benefit from an expansion, deepening and organization of these and other activities that constitute its public culture. Our limited stay in Auroville (along with personal visits over the years) gave us glimpses of this culture – but more in-depth accounts, for example, Kapur's *Auroville: Dream & Reality*, an anthology capturing Auroville's rich and complex social fabric, Majumdar's *Auroville: A City for the Future*, an insightful personal narrative of the dynamics of the collective, demonstrate the importance of cultural stewardship of the public sphere.³¹⁹ Just as lands are physically stewarded, so must cultural spaces.

The role of culture in personal identity formation (and thus aligned patterns of behaviour), for each resident of Auroville to locate themselves in relation to the whole, cannot be overestimated – it *shapes* us, and provides the (often invisible) background, or for the youth, the horizon, within which individual evaluations can meaningfully occur:

Commitment to certain 'higher,' or more basic, goods provides us with the capacity to locate ourselves, to establish an identity, and to determine the significance of various events or things for us. These 'hypergoods' or 'constitutive goods' are ... constitutive of human agency, that stepping outside these limits would be tantamount to stepping outside what we would recognize as integral, that is, undamaged human personhood.³²⁰

Needless to say, building cultures, spiritual ones even more so, is not a simple or straightforward task, nor one that can be accomplished through a set of prescriptive policies or

³¹⁹ See, generally, Kapur, 2018; Majumdar, 2017.

³²⁰ Calhoun, 1991, 234.

mandatory programmes, but by long and consistent brewing by many hands, over time. Our discussion here, therefore, only touches the surface. Practically, this architecture of the public space, through a wide and interlaced net of public fora, assists in moving, in practice and life, towards a progressively deeper consensus across a diversity of views over matters of public concern, the development of the Crown, management of collective assets, economic growth, village relations and so on. Unity in diversity demands close contact and exchange, not a loose association and tolerance bred by distance – the latter is evident given the problems in Auroville today of low rates of participation in collective fora, low population density and sprawl. The public space, in other words, is more than an aggregation of separate individuals aggregated, but a collective force of its own that drives acculturation processes of newcomers and others: a spatial concentration of Auroville’s ‘group-soul.’³²¹ This centripetal social force can (i) channelize youthful energy, (ii) bring diversity in close, intimate contact, generating friendship and people to people connections, leading to camaraderie and trust, (iii) support generational and institutional continuity through a healthy mimesis (particularly important given the generational shift Auroville is witnessing today), (iv) generate an informal space independent from the often overloaded administrative and political machinations of the Residents’ Assembly and Working Groups, suitable for a friendly and free exchange of opinions and (v) help co-build artefacts, both physical and cultural, that anchor a sense of collective belonging.

We may also note here also (a point we will not pursue in detail) the importance of an aesthetically inviting physical environment in the city for moral and spiritual alignment, and reforming unbecoming, licentious behaviour. The centrality of beauty, perspective and form in Mother and Sri Aurobindo’s thought, the power of harmony, or *mahalakshmi* is a given – in education, social interaction, artistic expression in music, poetry, theatre or otherwise,³²² or physical form in painting, architecture, sculpture or city-planning. This is an important need to manifest in collective spaces – already the case with several spaces, owing to rich architectural experiments over the years – in the Crown and other emerging sites elsewhere not only for aesthetic reasons, but for their *governance* consequences:

It purifies by beauty. The beautiful and the good are held by many thinkers to be the same and, though the idea may be wrongly stated, it is, when put from the right standpoint, not only a truth but the fundamental truth of existence.

The work of purifying conduct through outward form and habitual and seemly regulation of expression, manner and action is the lowest of the many services which the artistic sense has done to humanity, and yet how wide is the field it covers and how important and indispensable have its workings been to the progress of civilisation! A still more important and indispensable activity of the sense of beauty is the powerful help it has given to the formation of morality.³²³

³²¹ See, for an insightful discussion, Taylor, 1985, Vol. 2, Chs. 7-8.

³²² See, Sri Aurobindo, CWSA, 1997, Vol. 27.

³²³ Sri Aurobindo, CWSA, 1997, Vol. 1, 440-44. For a discussion on the relationship of the aesthetic with the political, an exciting area for research in Auroville, see, Schiller, 1983.

A vital public space – both in physical terms, places to meet, and culturally, in terms of forms of life that bring us together – is not just a ‘nice to have’ extra, but a basic need.³²⁴ It *shapes* life:

Streets and public spaces define the character of a city. From squares and boulevards to neighbourhood gardens and children’s playgrounds, public space frames city image. The connective matrix of streets and public spaces forms the skeleton of the city upon which all else rests. Public space takes many spatial forms, including parks, streets, sidewalks and footpaths that connect, playgrounds of recreation, marketplaces, but also edge space between buildings or roadsides ... Public space forms the setting for a panoply of activities - the ceremonial festivities of the multi-cultural city, trade for the commercial city, the movement of goods and people, provision of infrastructure, or the setting for community life ...³²⁵

Leading theorists in this area, Charles Taylor and Jurgen Habermas, offer a textured historical narrative of the development and importance of public spheres in nurturing rich and secure communities, preventing concentrations of power and enlivening creative felicities.³²⁶ The spatial and cultural aesthetic of a democratic collective, aspiring to spiritual anarchism, is the practical side of the collective yoga, one that can allow for the emergence of a group-soul. A shared and polyvocal space, emerging from within through daily contact, can promote ‘a sense of belonging ... as well as transmit cultural practices’ with the full catalogue of its dissents and diversity.³²⁷ As the circle of identification expands, from the self to community, the need for external codes is *sua sponte* limited. In this vein, Sri Aurobindo paints a vivid picture of the public space in Athens, ‘in which living itself was an education’, recovering in Anger’s words the ‘old urban warmth’, an ideal for Auroville:

The cultural and civic life of the Greek city, of which Athens was the supreme achievement, a life in which living itself was an education, where the poorest as well as the richest sat together in the theatre to see and judge the dramas of Sophocles and Euripides and the Athenian trader and shopkeeper took part in the subtle philosophical conversations of Socrates, created for Europe not only its fundamental political types and ideals but practically all its basic forms of intellectual, philosophical, literary and artistic culture.³²⁸

This idea received careful attention by Schmidt in a 2003 essay entitled ‘On Public Spaces and the Development of the Crown’. Schmidt begins with a penetrating question – querying how (the vigorous but largely failed) town planning efforts discussed in Part III.A can find root in the community to enliven the public space:

Town planning, unlike building design, is a process that extends over a long time. While in ancient times it took centuries for a town to develop, we now do it in a few decades, but even so total control over the process is rarely possible. As the initiators and original planners get replaced, visions and opinions change. The following

³²⁴ Kim, 2015; Duivenvoorden et. al., 2021; Anastasiu, 2021.

³²⁵ UN Habitat, Module 6, 2019, 1.

³²⁶ See, in general, De Angelis, 2021; Habermas, 2001, 2021; Taylor, 1991; Calhoun, 1991.

³²⁷ Low, 2022, 1; Hirschcop, 1999, 249-271.

³²⁸ Sri Aurobindo, CWSA, 1997, Vol. 25, 360.

generation tends to look at things differently. Usage and experience might not confirm the planners' intentions (as many examples show, Chandigarh being one of them). Human nature will reject the idealistic planners' cry of 'We want to avoid anything bad', unless the basic principles of their planning are so true and self-evident that they cannot easily be undermined or set aside.³²⁹

Schmidt points then to the street as the public space that binds the community, pointing to the need to conceive of the Crown as more than a functional road, but in its social and psychological implications:

The street, determining a system of movement and a sequence of public spaces, may be considered the most vital institution in a city. Town planning starts with the street (and not with individual buildings, which are subordinate to it). In this sense, the street is the forerunner of all the institutions and buildings to come.

...

Being able to move about easily and confidently, to linger between buildings, to take pleasure in the spaces and buildings and life of the city, being able to mingle and move amongst other people – informally or in a more organized fashion – are possibilities that are fundamental to good cities and good building projects, today as in the past, in Auroville as elsewhere. The human quality of city streets and public spaces can play a major part in fostering these experiences.

...

These aesthetic principles [of the Renaissance, where 'formal considerations and visual expression were given priority'] were supplemented in the early 20th century by the physical, physiological and functional ideas of a movement called Functionalism, which formulated criteria for healthy and physiologically suitable architecture based on the development of medical and hygienic knowledge. Buildings were oriented towards the sun rather than towards the street, green recreational areas were integrated into the city plan, work areas were separated from residential areas and public urban spaces were more or less eliminated.

Nowhere did the functionalists mention the psychological and social aspects of the design of buildings and public spaces. That these could influence social activities and contact patterns amongst people was not their concern. Functionalism was a distinctly physically and materially oriented planning ideology. Its most noticeable effect has been that streets and squares disappeared from town-plans and were replaced by 'roads': spaces designed for the rapid movement of individual motorized traffic, often between endless grass lawns for 'recreation'. The automobile made its appearance as the pet of planners for decades to come.³³⁰

Pointing to the negative spaces between buildings, the *public* space, as 'more essential and more relevant than the ... buildings themselves' to generate identity and loyalty amongst the residents, he points to the pitfalls and possibilities:

³²⁹ Schmidt, 2003, 1.

³³⁰ Schmidt, 2003, 2-3.

The life that takes place in and between buildings seems almost always to rank as more essential and more relevant than the spaces and buildings themselves. We know that human beings need contact. Apart from contacts at work, at school, at home in the family or other 'arranged' groups, there is a need for the unpredictable, the spontaneous and unplanned. For example children often prefer to play on the street rather than in the well-equipped playgrounds prepared for them. We want these spontaneous contacts to happen in a relaxed way and not on the relatively formal level of school or workplace. Children see and learn how others work, behave and dress, and through this information and experience establish a confident relationship with the world around them. We are inspired by seeing others in action. Seeing other children or adults at play, children get the urge to join in and have ideas for new games. This often happens on the way to and from school. Street life, the safety of street space and its use by pedestrians play a major part in fostering this learning process. The luxury or need of taking children to school by car has unfortunately replaced that field of experience; it probably makes children eager to become car drivers as soon as possible.

Informal contact often takes place amongst pedestrians, but hardly happens between car drivers. A city designed to be experienced by pedestrians, offering beauty and variety in concordance with 'eye and foot' (Louis I. Kahn), becomes penetrable and transparent, interesting and small in dimension, but rich in experience. It creates identity amongst its citizens, more loyalty to their city, and a fundamental feeling of human agreement and belonging. 'The whole idea of downgrading and minimizing the social part of the street in city life is the most mischievous and destructive idea in orthodox city planning; that it is so often done in the name of vaporous fantasies about city child care is as bitter as irony can get', writes Jane Jacobs.³³¹

In 1968, Anger narrated a similar sentiment for a 'rehabilitation of streets', 'the dialogue of man with man' – though with design differences from others, he provides an insight into the socio-psychological thinking behind the volumetric orientation of the Galaxy:

In order to achieve the integration of man with his social community, we had to rediscover what made those small towns of southern Europe successful – they were so beautiful and the inhabitants were happy living in them. One reason for their success came from their construction on slopes: one could discover constantly new viewpoints, new angles for seeing space and shapes. Another reason is that they not only offered a dynamically permanent environment but also an environment adapted to man's dimensions. In our effort to bring together all these factors of success we developed a concept of urbanism now called 'volumetric'. 'Volumetric urbanism' consists in recreating on selected artificial sites progressive levels with multiple perspectives. The town consists of a macrostructure, created with terraces on successive levels, that looks like a real pyramid when stripped to its essentials.

The pyramid is fitted on its exterior planes with levels of habitation which give an extraordinary contact with nature. Inside, one finds a complete complex of things necessary for living: cultural and recreational centres, commercial outlets etc. The pyramid's vertical axis contains systems of high speed elevators and escalators offering quick circulation with and between the levels and easy communication to

³³¹ Schmidt, 2003, 3-4.

residential sectors. Such a pyramid constitutes a complete organic unit for ten to fifteen thousand inhabitants. When several are positioned on the ground, interconnected by causeways, a growth pattern is established which could finally contain half a million people. Each unit enjoys naturally its own life and relations with others. The number of people in each organic unit is limited so that intimate human relations remain possible, so that a kind of open fraternity can exist, a necessity in the town of the future. We feel that an important number of contacts between individuals is so necessary for a balanced community existence that, with the help of modern technology, we conceived an architecture which aims at inducing this cohesion, this warm mutuality. In short, we start with artificial platforms, terraces on which we have positioned a highly concentrated habitat.

Running against this conception, modern western urbanism for the last twenty-five years has been geometric, horizontal – it has killed human relations and been a dramatic failure. People are isolated, lost, within a living unit neither self-sufficient nor self-contained, separated from others by lawns and linear lots. Redensification is today's necessity. Citizens of these new cities may enjoy once again (as was the case with streets and forums of the past), the dialogue of man with man.

...

Auroville will attempt the rehabilitation of streets, a change from rush-ways to a satisfying and happy system of circulation for man, from meeting place to meeting place: squares, fountains, gardens, pools, staircases, wings of shade, sudden shafts of sunlight, perspectives, auditoriums, amphitheatres, theaters, sports-grounds, research and leisure centers, restaurants and shops...

In the residential zone these streets, with all their meeting places, will become arteries for creative neighborhoods (not dormitories) of people enjoying some particular common activity that will be their distinctive mark, a source for unique offerings to others. In the central ring, other meeting places will be found to accommodate several such groups. Finally, in the cultural zone, installations will be built where the whole town may enjoy festivities with as many as a hundred thousand present.³³²

A similar emphasis came in the early Dreamcatching 'mobility pearls' and 'Crownway' studies in 2009, for 'streets instead of roads', where:

... moving from A to B ... should be an experience and not merely a function ... a ritual and a celebration – the township's 'crown' should be both elegant and profound, and should offer a wide range of experiences ... it is essential that the Crown works to connect and not divide Auroville in any way.³³³

These 'convivial streets' as Bertolini notes in her review of mobility planning, are constitutive features of the public space – they are the spatial key to 'psychological oneness' in Auroville's emerging urban social fabric:

Convivial streets are the first and perhaps most defining building blocks at the most immediate scale of the direct surroundings of the home and the workplace. Emerging practices and insights stress that the street should be seen ... as first and foremost the

³³² Anger, '1', 1968.

³³³ Mobility Pearls, 2009, 3.

quintessential urban social public space, with all its human and more-than-human relational richness. Urban planning should shift away from motorized traffic as the dominant guiding principle for city street design and regulation. Other, including non-motorized and most importantly non-mobility-related public space uses such as socializing, lingering, or playing, should be treated equally, reflecting a radical diversity of functions and values. While the more limited presence, and in some case even absence, of motorized traffic could reduce accessibility, it could also generate new accessibility. It can, for instance, enhance social contacts in the neighbourhood, and provide space for relaxation and play close to the home.³³⁴

If conceived and developed along these lines, Schmidt's ends with the reminder, resonating Sri Aurobindo's description of Athens, that 'closeness, human scale and the old friendship between street and buildings will be recreated.'³³⁵ This is why the development of the Crown is a singularly important activity, not just as a functional road, but as Anger and others insist, an aesthetically inviting focal point of the town's energies. This is an opportunity for Auroville to address the practical side of the debate between individual and communitarian forms of organization discussed in Sri Aurobindo's thought above: and in doing so, develop a rich public sphere that generates interchange, cohesion and intimate contact in a 'secure unity' whilst fostering a fluid and free variation of sub-cultures and individual space (the 'ideal law of social development' in the *Human Cycle*). As we discussed in Part II, this was the planning philosophy behind Anger's 1969 proposal to Mother, enthusiastically welcomed by her.

The *form* of the public space provides a mould for the *substance* of public-spiritedness and solidarity to develop: this goes – as we discussed in Section A above – from a geographical or physical unity (all residents sharing a common land / the plan area), to an administrative and political one (common participation in Working and Zonal Groups, under the umbrella of the Auroville Foundation), further deepening into a rich social and economic fabric (through a shared infrastructure of production / commercial services, shops, restaurants, schooling, research and cultural activity etc. in the public space across the four zones), all leading to the final culmination of a psychological and spiritual oneness (the ideal of the collective yoga). For this, at a minimum, the physical and social sprawl in Auroville, demonstrated sectorally in Part III, requires a corrective.

This is a challenge at various levels: spatial planning (developing beautiful physical spaces that permit and encourage such public contact, understanding the social logic of space), social (forms of micro-level individual interactions), political (policies and programmes that incentivize and signal support), economic (adequate investment in these activities) and spiritual (travelling the path of the yoga). As we note in Parts III and IV, urban planning in Auroville has to play a critical part in this story, and thus has unsurprisingly been the primary situs for disagreement.

This slight detour is important to highlight the point that resolving the tension between regulating behaviour unbecoming of Auroville's ideals and a distrust of paternalism or imposition from an external authority depends ultimately – as Sri Aurobindo says in the

³³⁴ Bertolini, 2023, 2357.

³³⁵ Schmidt, 2003, 4-5.

culminating chapter of his *Human Cycle* – on an inner evolution leading to ‘a renovation of ...society’, in art, politics, industry, ethics, education and social effort.³³⁶ Practically, in Auroville’s context, it depends (i) on the quality and vibrance of the public culture that exceeds a simple summation of separate individual efforts and actions, in an isolated sprawl with limited interaction across differing views and (ii) the spirit of respectful, inclusive and informed dialogue, that does not shy away from discussing and promoting valuable forms of life, and openly rejecting those that do not, for fear of being authoritarian. In this regard, our conversations often betrayed seemingly hard divisions between ‘pro’ and ‘anti’ city groups, mutual assertions of dogmatism on either side of the aisle, rhetorical and polemic rather than fact and issue-based exchanges informed by research. Such entrenched positions drown out sober debate and are unhelpful to ground a constructive public culture that can support healthy self-appraisal and reasonable disagreements.

A living spiritual culture is the best bulwark against licentious activity and lack of cohesion (‘each pulling in his own direction’), especially as population numbers grow. Enforcement of rules is a legitimate, required but special remedy to be utilized sparingly, recognizing – as Mother did in her dealings – the necessity for as wide as possible a space for experimentation and error, for growth and discovery. Mother makes this position clear, echoing Sri Aurobindo’s view that spiritual compulsion is preferable to rule enforcement:

The freedom given to people is above all to enable them to reach a higher consciousness. The essential thing is not to impose rules, *but* to create an atmosphere that leads towards another way of life. Those who cannot accept it will leave of themselves.³³⁷

In sum, in navigating the choppy waters between value blindness and value monism, Raz’s account pushes for a rich, value plural public sphere – fleshing out in many ways Mother and Sri Aurobindo’s approach to the issue – that allows us to engage in reasoned conversation with each other, generating a collective space that is self-consciously moral, yet plural, and liberal, yet not licentious. As Raz notes, echoing several conversations during our research:

Supporting valuable forms of life is a social rather than an individual matter ...It requires a culture which recognizes it, and which supports it through the public’s attitude and through its formal institutions ... Anti-perfectionism in practice would lead not merely to a political stand-off from support for valuable conceptions of the good ... [i]t would undermine the chances of survival of many cherished aspects of our culture.³³⁸

v. Place of Mother and Sri Aurobindo’s Thought

It is relevant here to reflect on the place of Mother and Sri Aurobindo’s thought – one of the ‘cherished aspects of our culture’ – in Auroville’s public space, a question that came up often in our interviews. Simply put, their philosophy, practice and life are naturally central to the founding ideal, and continued development of Auroville as the *karma bhoomi* for the Integral

³³⁶ Sri Aurobindo, CWSA, 1997, Vol. 25, 261.

³³⁷ Guigan, 2018, Vol. 1, 370 (emphasis ours).

³³⁸ Raz, 1986, 160.

Yoga. Yet, in that practice, two short points are important given discussions during our research that pointed – in the interviewees’ assessments – either to a ‘religious dogmatism’ of their words on one hand or a sidelining of their presence on the other.

a. Inclusiveness and Syncretism

First, Sri Aurobindo and Mother’s spiritual path, as we discussed above, is not inconsistent with other paths – individuals drawn to other paths have a natural home in Auroville. Mother’s entry rules for Auroville, unlike the Ashram, were broad, requiring goodwill, sincerity and a commitment to discover the truth progressively in a collective setting. Indeed, atheists, agnostics and others of a different persuasion too are welcome – a point Mother alludes to as well.³³⁹

Mother and Sri Aurobindo’s spiritual thought is maximally inclusive.³⁴⁰ It welcomes all approaches to the Divine, itself encompassing a wide variety of approaches, drawn from the orthodox traditions and otherwise. There are infinite paths to the infinite reality: ‘there is only one truth, one reality, but the forms through which it may be expressed are many.’³⁴¹ Commenting on Sri Ramakrishna, a man of multiple religious belonging (including Tantra, Vaiṣṇavism, Advaita Vedānta, Islam, and Christianity), who realized the Divine in the personal and impersonal, with and without form, transcendent and immanent, through a variety of devotional forms and contemplative practices, Sri Aurobindo noted that it is *this* example of a deep overlapping consensus, a synthesis of diverse paths that ought to guide us:

[Sri Ramakrishna’s] object ... was special ... to exemplify in the great and decisive experience of a master-soul the truth, now most necessary to humanity, towards which a world long divided into jarring sects and schools is with difficulty labouring, that all sects are forms and fragments of a single integral truth and all disciplines labour in their different ways towards one supreme experience. To know, be and possess the Divine is the one thing needful and it includes or leads up to all the rest; towards this sole good we have to drive.³⁴²

Expanding on this in his *Synthesis of Yoga*, Sri Aurobindo details a capacious, integral and life-affirming practice that blends the paths of knowledge (*jnana*), love (*bhakti*) and works (*karma*), one that provides a unique avenue for each person to the Divine. Each path finds a natural fulfilment in the other, allowing those with devotion to start there and blend in the dynamism of works and the illumination of knowledge, those with a contemplative bent to enliven the heart and life, and those with a strong kinetic element, to use works to purify the heart and mind:

³³⁹ Mother, 2018, Vol. 1, 129 (‘Q: Can one be an atheist in Auroville? Mother’s response: If one has not gone beyond that’)

³⁴⁰ We superficially address this subject area, that demands a far deeper analysis. This is an exciting area for comparative research in Auroville. For Sri Aurobindo’s discussion on the relationship of the Integral Yoga with other paths, see, Sri Aurobindo, Sri Aurobindo, CWSA, 1997, Vol. 31, Section II. For a lucid and incisive discussion on religious plurality, inclusivism and exclusivism that can be adapted to Sri Aurobindo’s thought, see, Medhananda, 2022, 91-138.

³⁴¹ Mother, CWM, 2002, Vol. 3, 17.

³⁴² Sri Aurobindo, CWSA, 1997, Vols 22-24, 41-2.

Love without knowledge is a passionate and intense, but blind, crude, often dangerous thing, a great power, but also a stumbling-block; love, limited in knowledge, condemns itself in its fervour and often by its very fervour to narrowness; but love leading to perfect knowledge brings the infinite and absolute union ...³⁴³

In this, other traditions are welcomed – they are not just tolerated, but synthesized. Speaking of the *sanātana dharma*, an empirically verifiable ‘eternal religion’, not a sectarian one, Sri Aurobindo notes that it has ‘has many scriptures, Veda, Vedanta, Gita, Upanishad, Darshana, Purana, Tantra, nor could it reject the Bible or the Koran.’ But its real, most authoritative scripture, he reminded young nationalists in 1909, ‘is in the heart in which the Eternal has His dwelling.’³⁴⁴ To this end, Aurobindo exhorted the youth to question Hinduism (and we may apply this to his own thought) and to think originally, ‘accepting nothing on trust from any source whatsoever, by questioning everything’ and to ‘break ... chains, venerable as they are, in order to be free’. We need not fear, he told his audience, that we ‘shall by that process ... fall into the danger of abandoning Hinduism ... Hinduism [can never cease] to be Hinduism, if we really think for ourselves.’

We may note here, as some conversants brought up the issue, the link between Sri Aurobindo’s reference to the *sanātana dharma* and Hinduism insofar as Auroville’s ideal is concerned.³⁴⁵ This is a complex subject that warrants a more detailed study than we can engage here, but two short comments can be made. First, Sri Aurobindo’s reference to Hinduism in the passage above is not associated with any particular creed or sectarian, ‘religious’ outlook. He had, to use a pungent turn of phrase of his fashioning, ‘no intention of giving his sanction to a new edition of the old fiasco.’³⁴⁶ Rather, he refers to a heterodox and above all, experientially validated claim to truth accessible through many paths and traditions. Elsewhere, Sri Aurobindo draws a distinction between the a ‘higher and truer Hinduism’ and a lower one, the first aspiring to spiritual experience and the second focussing on external ornaments.³⁴⁷ The higher Hinduism ‘is also of two kinds, sectarian and unsectarian, disruptive and synthetic, that which binds itself up in the aspect and that which seeks the All.’ This second, non-sectarian sense of Hinduism, ‘which exceeds Hindusthan, was from of old and will be for ever, because it grows eternally through the aeons’ is what he refers to as the *sanātana dharma* above and considers the omnipresent reality, the Divine *sachchidānanda* in the *Life Divine*, discussed in Part I.A.³⁴⁸ It is this conception which we can take to be central to Auroville’s spiritual ideal. Naturally, there are complex linkages between this conception and a host of valuable cultural and religious traditions rooted in the Indian subcontinent, part of India’s long heritage and genius that can be lived, supported and promoted in Auroville’s diverse milieu. This was

³⁴³ Sri Aurobindo, CWSA, 1997, Vols. 23-24, 547.

³⁴⁴ Sri Aurobindo, CWSA, 1997, Vol. 8, 9.

³⁴⁵ See, for example, Auroville Today, May, 2023.

³⁴⁶ Mother, CWM, 2002, Vol. 4, 348-9.

³⁴⁷ Sri Aurobindo, CWSA, 1997, Vol. I, 551-553.

³⁴⁸ See also, Sri Aurobindo’s related distinction between ‘true religion’ and ‘religionism’, Sri Aurobindo, CWSA, 1997, Vol. 25, 177. There is, as Alan points out, a change in emphasis in Sri Aurobindo’s thought from his nationalist writing to the *Arya*, which requires a closer study, but we do not have the space to enter that debate here.

Mother's ideal for the Bharat Nivas. Sri Aurobindo advocated an embrace of past traditions, not their rejection:

The *recovery* of the old spiritual knowledge and experience in all its splendour, depth, fulness is the first, most essential work; the flowing of this spirituality into new forms of philosophy, literature, art, science and critical knowledge is second.³⁴⁹

Second, Sri Aurobindo's wide-ranging *oeuvre* betrays insularity in a credal appreciation of his yoga – 'for he is not the sadhaka of a book or of many books; he is a sadhaka of the Infinite.'³⁵⁰ To the contrary, it pushes us to read, research and live cross-culturally in the humanities in the yet to be developed tertiary research infrastructure in Auroville. Equally, a continuing engagement with works since their passing, and those emerging today, is necessary to 'awaken and enrich [Auroville's] own cultural activities and cultural being' and place it as a world-leader in research.³⁵¹ This spirit of assimilation through cross-cultural interchange is encoded in the Charter, and lacking by some accounts in Auroville today – it undercuts stagnation or a backward-looking nostalgia, and substitutes easy dogmatism or well-meaning devotional insularity with a healthy conversation (and searching examination) of Sri Aurobindo and Mother's views in conversation with other traditions of thought.³⁵² This both fulfils Auroville's mandate as a place of unending research and allows the strength of Mother and Sri Aurobindo's light to naturally radiate outwards through the force of quality research work.

b. Culture of Seeking Engagement

Given this, enforcing Sri Aurobindo and Mother's ideals, or considering them *a priori* unquestionable, is not the point. Nor is it wise to disincentivize critical, sincere questioning of their thought, which is a constitutive part of seeking: 'To commit adultery with God is the perfect experience for which the world was created', 'thy soul has not tasted God's entire delight, if it has never had the joy of being His enemy, opposing His designs and engaging with Him in mortal combat.'³⁵³ Indeed, Sri Aurobindo and Mother engaged with their disciples' pointed and irreverent questioning, including open revolt, with great love and patience, rarely insisting and never imposing their views on them. As Ghisi pointedly notes:

³⁴⁹ Sri Aurobindo, CWSA, 1997, Vol. 20, 15 (emphasis ours).

³⁵⁰ Sri Aurobindo, CWSA, 1997, Vols. 23-24, 55-56. The works of early disciplines nurtured at the Sri Aurobindo Ashram demonstrate this amply. *See*, for example, works by Nolini Kanta Gupta, Amal Kiran, Dilip Kumar Roy and Satprem.

³⁵¹ R. Meenakshi's acclaimed Tamil poetry, Sharaddhavan's 'The English of Savitri', and previous publications by Kireet Joshi, Georges van Vrekhem, Rod Hemsell, Vladimir Yatsenko are some notable examples. Other works are listed on the Auroville Research Repository. *See*, Part III.E for the urgent need for a well-funded research infrastructure to realize Auroville's potential. There are of course several acclaimed works written over the years globally, and research fellowships to invite these scholars to reside in Auroville and help develop the research landscape may be a useful pathway to grow.

³⁵² *See also*, for a detailed examination of this view, Sri Aurobindo, CWSA, 1997, Vol. 20, 43-54.

³⁵³ Sri Aurobindo, CWSA, 1997, Vol. 12, 481-2.

There is a difference between taking Sri Aurobindo and the Mother as a door of access to experience, and institutionalizing them as the last possessors of the final Truth [spiritualizing institutions versus institutionalizing spirituality].³⁵⁴

Yet equally, the other extreme, of considering their ideals irrelevant, archival or passé too is inappropriate (indeed, any reasonable reading of their works belays this view, a point we will not pursue here). This latter view was expressed in interviews and is found in the archival records. For example, Majumdar quotes an early resident: '[the] individual and his growth was more important than the city. Sri Aurobindo and Mother were passé. Only the Agenda was right.'³⁵⁵ Our limited interactions, backed by the views of some long-time residents, indicated that Mother and Sri Aurobindo's collected works (select quotations aside) seemed to have a limited resonance compared to the *Agenda* and Satprem, as Mother's primary interlocutor.³⁵⁶ Some suggested that this is the imprint of the early years, when Satprem's charismatic personality attracted strong loyalty. This sentiment is discussed in a surprising and humorous exchange in the *Agenda*, worth quoting at length:

S. [Satprem]: Oh, you know, in the name of my book [*Sri Aurobindo or the Adventure of Consciousness*, an introductory volume, followed up later by a series of extraordinary texts] they also say that Sri Aurobindo and Mother are now obsolete, and that in a way my book supersedes all that!

Mother: Yes, oh, exactly! (general laughter)

S.: I've heard just about everything.

Mother: Yes, that's it! (laughter)

S.: So, what can I say in the face of such things!?! (Mother laughs) S.: One even wrote me, 'So, Sri Aurobindo didn't have the key to the superman.'

Mother: Oh, really?

S.: Yes, I'm the one who's given it, you see.

Mother: Good heavens!

S.: It's bewildering! (Mother laughs)

Mother: I think there are no limits to human stupidity.

...

S.: I replied [to an architect who wanted to meet him]: 'Auroville's problems will be solved and cleared up only when Aurovilians turn directly to Mother, and hence I

³⁵⁴ Ghisi, 2010, 25.

³⁵⁵ Majumdar, 2017, 228.

³⁵⁶ For an introduction to Satprem and the relevance of his *yoga*, see, Joshi, 30 in Joshi (ed.), 2011.

wish they would go directly to the Source instead of going to an intermediary [Satprem].³⁵⁷

What is required then is a settled culture of ‘going to the source,’ of deep engagement with Mother and Sri Aurobindo’s works and spirit, through a variety of public and private fora – as for example Savitri Bhavan, Samskirtam, Agni Veda, journals like *Bhavishyate*, *Matrimandir Journal*, *Invocation*, *Prarthana*, *Auroville Seythi Mandal*, the practice in several schools, as for example the Last School, Isai Ambalam, Illaignarkal, of offering their ideas appropriately in school curricula, recent consultations conducted by SAIER with schools on the relevance of Mother and Sri Aurobindo’s thought on education, archival exhibitions allowing residents to explore Mother’s words on Auroville, musical and artistic offerings (events in the Unity Pavilion, Sri Aurobindo Auditorium, Bharat Nivas, the upcoming Auroville Literature Festival, exhibition of Huta’s paintings on *Savitri*, *Ragamantra*, etc. of which we had the privilege to attend some in the cultural and international zones), *Savitri* reading groups in various fora, the Dreamweaving meetings that introduced Mother’s thought, briefs for the construction of Bharat Nivas that included selections from Mother and Sri Aurobindo’s completed works as ground for reflection and various others that space does not permit us to list. These net of micro-fora, sustained by small collectives, are a critical design feature of Auroville’s social fabric to allow each to reach their own conclusions aided by a collective space that encourages, supports and guides that exploration. It is but obvious that a living spiritual culture cannot be created by notifications, office orders or codes of conduct.

c. *Entry and Acculturation*

Professor Joshi remarked, in his time as chairman of the Governing Board, that a culture of reading Sri Aurobindo and Mother is wanting (not select quotations from their works, which were common in our limited conversations). Many conversants expressed a similar sentiment. If so, this is important to address, particularly for newcomers. The Governing Board addressed this concern in its 61st meeting, suggesting that programmes for residents and newcomers ‘may be conducted every quarter ... to ensure that all aspects of the Integral Yoga are continually nurtured in Auroville.’³⁵⁸ While participation must ideally be voluntary (with a well-curated diversity of programmes that one can choose between), a healthy culture of engagement and seeking supported by such programmes (and led by experienced hands) is a *sine qua non* for Auroville’s public culture.

It bears mentioning here that an initial ‘call’, even for those destined for the path, requires constant nourishment, support and rejuvenation, to battle the natural veiling of the aspiration born of challenges that come in the way. The mandate of the Entry Service, we may suggest, travels beyond a determination of entry to acculturation. Entry into Auroville after the newcomer process, then, is only the beginning of the journey. It may end in many ways:

If the change comes suddenly and decisively by an overpowering influence, there is no further essential or lasting difficulty ... But this is not always the manner of the

³⁵⁷ Guigan, 2018, Vol. 2, 289.

³⁵⁸ 61st Minutes of Meeting of the Governing Board, Auroville Foundation, 2022, 19.

commencement. The sadhaka is often led gradually and there is a long space between the first turning of the mind and the full assent of the nature to the thing towards which it turns. There may at first be only a vivid intellectual interest, a forcible attraction towards the idea and some imperfect form of practice. Or perhaps there is an effort not favoured by the whole nature, a decision or a turn imposed by an intellectual influence or dictated by personal affection and admiration for someone who is himself consecrated and devoted to the Highest. In such cases, a long period of preparation may be necessary before there comes the irrevocable consecration; and in some instances it may not come. There may be some advance, there may be a strong effort, even much purification and many experiences other than those that are central or supreme; but the life will either be spent in preparation or, a certain stage having been reached, the mind pushed by an insufficient driving-force may rest content at the limit of the effort possible to it. Or there may even be a recoil to the lower life, — what is called in the ordinary parlance of Yoga a fall from the path. This lapse happens because there is a defect at the very centre. The intellect has been interested, the heart attracted, the will has strung itself to the effort, but the whole nature has not been taken captive by the Divine. It has only acquiesced in the interest, the attraction or the endeavour. There has been an experiment, perhaps even an eager experiment, but not a total self-giving to an imperative need of the soul or to an unforsakable ideal.³⁵⁹

The task at hand is difficult enough at an individual level – ‘I do not wish to disguise from you the difficulty of this great and tremendous change or the possibility that you may have a long and hard work before you ...’³⁶⁰ Proposals like that of the Governing Board, and many other more informal, local, tailored and spontaneous forums for authentic exploration, can create an enabling environment for this growth: to make of Auroville’s public sphere a *consecrated space*, an environment that exerts a force of spiritual compulsion to nourish and grow ‘the thirst for Love and Truth’, and in times of difficulty, support.³⁶¹ It is this force that will ultimately attract and retain newcomers, or lead to natural self-selection out if one is drawn to other, desire-led modes of life. The quality of the environment pushes one to align or exit. Mother advances this point clearly:

I know it’s not easy, but we are not here to do easy things; the whole world is there for those who like an easy life. I would like people to feel that coming to Auroville does not mean coming to an easy life – it means coming to a gigantic effort for progress. And those who don’t want to keep up with it should leave. That’s how things stand. I wish It were so strong – the need for progress, for the divinisation of the being, so intense – that those who are unable (unable or unwilling) to adjust to it would leave by themselves: ‘Oh, this is not what I expected.’ As it is now, all those who want an easy life and to do what they please as they please, say, ‘Let’s go to Auroville!’ It should be just the opposite. People should know that coming to Auroville means an almost superhuman effort for progress.

...

We are here to prepare a superhumanity, not to fall back into desires and easy life – no. People must feel it; it should be so strong that the sheer force of our sincerity

³⁵⁹ Sri Aurobindo, CWSA, 1997, Vols. 23-4, 70-71.

³⁶⁰ Sri Aurobindo (eds. Nahar et. al.), 2003, 39.

³⁶¹ Mother, CWM, 2002, Vol. 11, 6.

would drive them out – that’s what they have to feel. At that point, we will be what we should be. The power of the realisation – of the sincerity of the realisation – is such that it’s UNBEARABLE to those who are insincere. We are here to prepare a superhumanity, not to fall back into desires and easy life – no.

People must feel it; it should be so strong that the sheer force of our sincerity would drive them out – that’s what they have to feel. At that point, we will be what we should be. The power of the realisation – of the sincerity of the realisation – is such that it’s UNBEARABLE to those who are insincere.³⁶²

A recent, thoughtful interview of the Entry Board in *Auroville Today* recognizes this concern and the practical difficulties in managing the entry process – they facilitate newcomer access to Mother and Sri Aurobindo’s texts (though forums and formats for doing so need to be developed and expanded systematically), without trying to turn it into a reductive, flat affair of memorizing lines or ‘gaming’ the system to get access to Auroville.³⁶³ It is ultimately work and the quality of the community / ‘mentor’ one engages with, rather than an interview, that can test one’s fitness.

There is much daylight between enforcing or preaching and sidelining to the fringes – securing that space through active engagement with their works is important. Effective facilitation of such programmes will naturally aim, as in the free progress method, for an environment for self-directed learning, inquiry, critical thought and practice, rather than overdone instruction. Here, as the Governing Board suggests, the help of practitioners outside can be helpful, particularly in the Sri Aurobindo Ashram and institutions like the Sri Aurobindo Centre for Advanced Research, Indian Psychology Institute in close proximity to Auroville. Indeed, a similar space for other traditions too is important to cultivate, to strengthen the diversity of offerings for those drawn to them in Auroville’s international milieu.³⁶⁴ Our proposal for a research-agenda for the Cultural Zone, alongside infrastructure development plans, and the urgency of the need to develop of research centres in collaboration with leading universities / monastic orders in the International Zone engaged in spiritual research and practice across the major faith traditions, can be considered in this context, as anchoring this process of syncretic, cross-cultural spiritual offering in Auroville. The rich diversity of spiritual traditions, mingling and cross-pollinating, perhaps with inevitable creative friction, can only add to the depth and colour of Auroville’s social fabric.

Needless to say, spiritual education does not come in standard lecture settings. It is not an easy task to develop such programmes as suggested by the Governing Board. This will require a dedicated stream within the Entry Service (and other fora dedicated too research on Mother and Sri Aurobindo, and other paths) to develop, innovate and sustain a range of offerings suited to varying temperaments:

³⁶² Guigan, 2018, Vol. 2, 360-1.

³⁶³ See, Auroville Today, June-July, 2023; see also, as one of several inspiring stories of local Tamil employees transitioning to Auroville, Auroville Today, June-July, 2023.

³⁶⁴ See, for example, Svadharma, work of the ‘Mira Cultural Group’, events at the Savitri Bhavan, Savi Youth events and others. Our review here is incomplete.

The soul that is called to this deep and vast inward change, may arrive in different ways to the initial departure. It may come to it by its own natural development which has been leading it unconsciously towards the awakening; it may reach it through the influence of a religion or the attraction of a philosophy; it may approach it by a slow illumination or leap to it by a sudden touch or shock; it may be pushed or led to it by the pressure of outward circumstances or by an inward necessity, by a single word that breaks the seals of the mind or by long reflection, by the distant example of one who has trod the path or by contact and daily influence. According to the nature and the circumstances the call will come.³⁶⁵

Indeed, Mother and Sri Aurobindo's thought is indispensable to the success of Auroville – given its uniquely life-affirming, terrestrially oriented synthesis of previous traditions and the impossibility of success in this endeavour without the grace of the Divine Mother, 'for she alone has the needed force, decisive, all-wise and illimitable.'³⁶⁶ But that is a conclusion each must reach after due reflection and (perhaps long) varied experience, with the manifest possibility of disagreement, doubt, revolt and in some cases, exit left open. Eccentricity, variety, creativity and play are invaluable qualities for seeking. Faith can neither be forced nor imitated by a pious recitation of revealed truths. It must be lived inwardly, and authentically, by each in their own way:

Each man has to grow into the Divine Reality within himself through his own individual being, therefore is a certain growing measure of freedom a necessity of the being as it develops.³⁶⁷

Following from this, both dogmatism and easy rejection (a concern raised by several conversants) are misplaced. Sri Aurobindo's essay on 'Original Thinking' offers a useful foil to enter this debate – directed to the youth during the Indian nationalist movement, it rouses a passion for the independent play of intellect and an aggressive spirit of discovery that goes to the root of things, grounding in our view the ideal spirit of engagement with spiritual traditions, the Integral Yoga and others, in Auroville's public culture:

Our first necessity ... is that the youth ... should learn to think, — to think on all subjects, to think independently, fruitfully, going to the heart of things, not stopped by their surface, free of prejudgments, shearing sophism and prejudice asunder as with a sharp sword, smiting down obscurantism of all kinds as with the mace of Bhima. Let our brains no longer ... be swathed with swaddling clothes; let them recover the free and unbound motion of the gods; let them have not only the minuteness but the wide mastery and sovereignty natural to the intellect of Bharata

³⁶⁵ Sri Aurobindo, CWSA, 1997, Vols. 23-4, 69. *See also*, Professor Joshi's short remarks on this subject, Joshi, 1999, 8-12.

³⁶⁶ Sri Aurobindo, CWSA, 1997, Vols. 23-24, 86. We may also note that the essential, as opposed to functional, separation of Mother and Sri Aurobindo, as some indicated, is unsustainable from either side, a matter on which they were each unequivocal. This subject requires a fuller discussion, but their view is encapsulated in the following lines from *Savitri*: 'The Two who are one are the secret of all power / The Two who are one are the might and right in things.' Sri Aurobindo, CWSA, 1997, Vols. 33-4, 62-6.

³⁶⁷ Sri Aurobindo, CWSA, 1997, Vol. 25, 259.

and easily recoverable by it if it once accustoms itself to feel its own power and be convinced of its own worth.³⁶⁸

Accordingly, Sri Aurobindo and Mother's thought (or any interpretation of it) is not to be accepted blindly, and care must be had to avoid a culture that turns well-intentioned devotion into the trappings of religion, with privileged or homogenous forms of practice or particular rituals marked out above others. Sri Aurobindo refers to this, in his characteristic flair, as a 'righteous oppression', that denies the 'freedom of thought involving necessarily the freedom to err and for freedom of action involving necessarily the freedom to stumble and sin'.³⁶⁹ Yet, their thought is also not an 'optional' in Auroville, easily ignored in the name of individual choice, a converse culture as one conversant put it of a reactionary 'religion of no religion.' Each must be allowed to follow their own path, their non-linear *dharma*, *within* a spiritually conducive public atmosphere that exerts a silent pressure.

We are here to prepare a superhumanity, not to fall back into desires and easy life – no. People must feel it; it should be so strong that the sheer force of our sincerity would drive them out – that's what they have to feel. At that point, we will be what we should be. The power of the realisation – of the sincerity of the realisation – is such that it's UNBEARABLE to those who are insincere.

(silence)

That's all.³⁷⁰

Just as Mother perfumed the air of Auroville with her Force, so must the public culture suffuse it with the *rasa* of a vibrant dialogue and aspiration, acting as a collective receptacle for the descent. In this, sub-cultures many naturally form, with a varying emphasis on Sri Aurobindo and Mother's thought and other traditions: as long as the general culture engages with their ideals, this is part of the required diversity. Any attempt to force or preach Mother and Sri Aurobindo's teaching as prescriptive moral codes or preach would be both self-defeating and contrary to the spirit of their work. As is a reluctance or indifference to engage with their thought or give it is due as part of Auroville's enduring constitutional architecture. What is most required is a spirit of deep and sustained exploration of their works, a culture of seeking. Indeed, in a sense, the sincere practice of any path to the Divine, whether it explicitly references Mother and Sri Aurobindo or not, is welcome, as all paths are contained in this one. The only limitation perhaps, we may say, is that the defining culture cannot be ascetic.

We thus suggest that their thought, encoded in the Charter, calls for a many-sided public ethos – a spiritual cosmopolitanism, represented most clearly in Mother's arrangement of the International and Cultural Zones – that can help secure a beautiful and happy community life (even leaving aside the lofty ideals of realization), if the public culture preserves and builds it, assimilating all good ideas from elsewhere. This is the principle of preservation and synthetic

³⁶⁸ Sri Aurobindo, CWSA, 1997, Vol. 12, 40-1.

³⁶⁹ Sri Aurobindo, CWSA, 1997, Vol. 25, 60.

³⁷⁰ Guigan, 2018, Vol. 2, 361.

reimagination of the spirit based on new contacts that Sri Aurobindo speaks of in his *Essays on Indian Culture* and elsewhere:

If we merely receive new ideas and institutions in the light in which they are presented to us, we shall, instead of selecting, imitate — blindly, foolishly and inappropriately. If we receive them in the light given by our previous knowledge, which was on so many points nil, we shall as blindly and foolishly reject. Selection demands that we should see things not as the foreigner sees them or as the orthodox Pandit sees them, but as they are in themselves. But we have selected at random, we have rejected at random, we have not known how to assimilate or choose.³⁷¹

Aurovilians are, in this way, the lucky inheritors of a robust, dynamic and indeed eternal tradition that ought to be preserved, fostered and grown, not seeing Sri Aurobindo and Mother as the founders of Auroville alone, historical figures of note, but ‘[keeping] open for *new* outpourings of their spirit ...’³⁷² As we noted variously in Parts I-III, to the extent past achievements, and current developments, across sectors elsewhere are resisted in Auroville without careful examination, as the ‘mainstream’ or ‘belonging to the old world’,³⁷³ the approach must widen:

Successful rejection is possible only if we have intelligent possession of that which we wish to keep. Our rejection too must be an intelligent rejection; we must reject because we have understood, not because we have failed to understand.³⁷⁴

d. Experience, Argument and Belief

The keynote of the Integral Yoga, indeed of most authentic spiritual paths, is experience, not belief. Until one has experienced, one does not know. This is a critical design principle, in a sense, for Auroville’s public space. Sri Aurobindo and Mother counselled against resting on beliefs (even if well-intentioned) unless validated by *experience*. What they insisted on repeatedly was an *empirical* validation of spiritual – or more accurately, super-sensuous – truths, as opposed to declarations of faith or dogmatic, even if well-intentioned, adherence to revealed codes, including their own writings.³⁷⁵ Conflicts, for them, arise because we look to narrow the Divine Infinitude into belief or intellectual systems – ‘religions’ – that render our approach to be inconsistent with others, the exclusive access-way, rather than reconciling them by going to the ‘fountain-head for all religion: direct spiritual experience.’³⁷⁶ Mother’s text written during one of the ‘Aspiration Talks’ on 19th May, 1970 encapsulates the ideal:

We want the Truth.

...

It is only in experience that there can be knowledge of the Truth.

³⁷¹ Sri Aurobindo, CWSA, 1997, Vol. 12, 40-1; *see also*, Vol. 20, 43-52.

³⁷² Sri Aurobindo, CWSA, 1997, Vol. 38, 179 (emphasis ours).

³⁷³ This was not uncommon usage in our interviews.

³⁷⁴ Sri Aurobindo, CWSA, 1997, Vol. 12, 39.

³⁷⁵ Sri Aurobindo, CWSA, 1997, Vol. 9, 46-7.

³⁷⁶ Medhananda, 2022, 141-296. This relates to Swami Vivekananda’s views, which are on this point consistent with Sri Aurobindo and Mother.

No one ought to speak of the Divine unless he has had experience of the Divine.
Get experience of the Divine, then alone will have the right to speak of it.

...

PROGRAMME

Research through experience of the Supreme Truth

A life divine

but

NO RELIGIONS³⁷⁷

Expanding on this sentiment, the following counsel by Sri Aurobindo provides the foundation for debate in Auroville's public sphere:

We begin also to perceive that the limitations we impose on the Brahman arise from a narrowness of experience in the individual mind which concentrates itself on one aspect of the Unknowable and proceeds forthwith to deny or disparage all the rest. We tend always to translate too rigidly what we can conceive or know of the Absolute into the terms of our own particular relativity. We affirm the One and Identical by passionately discriminating and asserting the egoism of our own opinions and partial experiences against the opinions and partial experiences of others. It is wiser to wait, to learn, to grow, and, since we are obliged for the sake of our self-perfection to speak of these things which no human speech can express, to search for the widest, the most flexible, the most catholic affirmation possible and found on it the largest and most comprehensive harmony.³⁷⁸

The experiences on the path of the Integral Yoga, beginning with an (often) long preparatory stage establishing a fundamental calm, peace and purity in the system ('the foundation', by no means easy to develop) amidst the challenges of work, are varied and vast.³⁷⁹ These are discussed at length in his *Synthesis of Yoga* and *Letters on Yoga*, a voluminous subject—he summarizes the kinds that lie in wait, that one must aspire to gradually through a firm practice, assisted by a collective aspiration that bolsters one's own:

... experience of the Self, experience of the Ishwara and the Divine Shakti, experience of cosmic consciousness, a direct touch with cosmic forces and with the occult movements of universal Nature, a psychic sympathy and unity and inner communication and interchanges of all kinds with other beings and with Nature, illuminations of the mind by knowledge, illuminations of the heart by love and devotion and spiritual joy and ecstasy, illuminations of the sense and the body by higher experience, illuminations of dynamic action in the truth and largeness of a purified mind and heart and soul, the certitudes of the divine light and guidance, the joy and power of the divine force working in the will and the conduct. These experiences are the result of an opening outward of the inner and inmost being and nature; for then there comes into play the soul's power of unerring inherent consciousness, its vision, its touch on things which is superior to any mental cognition; there is native to the psychic consciousness in its pure working, an immediate sense of the world and its beings, a direct inner contact with them and a direct contact with the Self and with the Divine,—a direct knowledge, a direct sight of

³⁷⁷ Guigan, 2018, Vol. 2, 119.

³⁷⁸ Sri Aurobindo, CWSA, 1997, Vols. 21-22, 33-4.

³⁷⁹ Sri Aurobindo, CWSA, 1997, Vol. 31, 287.

Truth and of all truths, a direct penetrating spiritual emotion and feeling, a direct intuition of right will and right action, a power to rule and to create an order of the being not by the gropings of the superficial self, but from within, from the inner truth of self and things and the occult realities of Nature.³⁸⁰

This search for direct experience, *pratyakṣa*, is the one central need towards which all spiritual striving moves. Auroville's public culture must ground this core tenet, to avoid conflicts resting solely on belief or what Sri Aurobindo calls 'dialectical warfare' over scripture, in this case Mother's words. In this context, it is interesting to note that in several interviews during our research, and in the records, we encountered a common tact, during debate and disagreement, of each side claiming – often with reference to select quotations – adherence to Mother's words and the ideal. In a good number of those cases, as we note with respect to the notorious 'elephants in the room' in Part I.D, this was akin to the story of the blind men and the elephant, each looking to claim that their partial sight is whole.

At a more human level, closer to where we are, these experiences begin – as Sri Aurobindo considers in some detail in the section entitled 'Human Relations and the Spiritual Life' in his *Letters on Yoga*, the social guide of Auroville one may say – with the (less exalted, but as important) classical virtues, that are to develop through a natural influence of the psychic being and not a violent ethicism. These are represented in the twelve outer petals of Mother's symbol that grant us access to the centre go a long way in the collective yoga. Absent this foundation, a condition precedent to the 'yoga of self-perfection', speaking of the higher states of realization – common in our conversations and for which Auroville is destined – is to put the cart before the horse.³⁸¹ The 'supra-ethical is itself a consummation of the ethical and cannot be reached by any who have not trod the long ethical road.'³⁸²

Similarly, given accounts of an anti-intellectualism in Auroville's culture, we may note that in this search for experience, intellectual work has an important place, for its critical questioning and demand for proof, logical ordering, imaginative ability, and, in cases of disagreement, its harmonizing of contraries as one rises higher. Dogmatism or a fall back into easy religiosity, not yet validated by experience, as also an unchecked vitalism in the name of spiritual practice, is avoided by a keen intellectual culture that refines beliefs and restrains the passions, shores up well-reasoned convictions and pushes insistently on a *verifiable* positive proof of spiritual truths:

It is necessary, therefore, that advancing Knowledge should base herself on a clear, pure and disciplined intellect. It is necessary, too, that she should correct her errors sometimes by a return to the restraint of sensible fact, the concrete realities of the physical world. The touch of Earth is always reinvigorating to the son of Earth, even when he seeks a supraphysical Knowledge.³⁸³

³⁸⁰ Sri Aurobindo, CWSA, 1997, Vols. 21-22, 942.

³⁸¹ Sri Aurobindo, CWSA, 1997, Vols. 23-24, 733-9.

³⁸² Sri Aurobindo, CWSA, 1997, Vol. 25, 152.

³⁸³ Sri Aurobindo, CWSA, 1997, Vols. 21-22, 13.

Spiritual practice is thus helpfully backed by philosophical rigour and intellectual exactness – Mother and Sri Aurobindo’s own voluminous texts, fifty-three intricately argued volumes in total, demonstrate the most exacting skeptical rationalism.³⁸⁴ Care must then be had to avoid a conflation between the supra-rational push of spiritual seeking with the anti-rational regress of vital subjectivism, an anti-intellectualism that looks to bypass the labours of ordered mental development.³⁸⁵ Sri Aurobindo registers this caution:

... the experiencing consciousness must preserve a calm balance, an unflinching clarity and order in its observation, a sort of sublimated commonsense, an unflinching power of self-criticism, right discrimination, coordination and firm vision of things; a sane grasp on facts and a high spiritualised positivism must always be there. It is not by becoming irrational or infrarational that one can go beyond ordinary nature into supernature; it should be done by passing through reason to a greater light of superreason. This superreason descends into reason and takes it up into higher levels even while breaking its limitations; reason is not lost but changes and becomes its own true unlimited self, a coordinating power of the supernature. Another error that has to be guarded against is also one to which our mentality is easily prone; it is to take some higher intermediate consciousness or even any kind of supernormal consciousness for the supermind.³⁸⁶

Equally, given accounts of a rejection of ‘traditional religious forms’ in Auroville, we may note that Mother and Sri Aurobindo did not reject the importance of ceremony, ritual or other ‘traditional’ modes of *bhakti*, or devotional religious expression, as useful and often necessary instruments for those drawn to them:

For according to the need of the human soul the Divine manifests himself as deity, as human divine or in simple humanity — ... for a means of transmission of his guidance.³⁸⁷

This quartet of patient ethical, vital, intellectual and aesthetic development is thus necessary.³⁸⁸ However, it is insufficient – stopping at well-reasoned intellectual conviction or faith-inspired

³⁸⁴ We were met with several instances, both in our conversations and the records, of statements such as, ‘but that is too mental’, ‘we must reject the mind’ and so on. While naturally reason has to be transcended into the supra-rational, it is not to be rejected but illumined. This process demands a progressive, careful and methodical elevation of mentality, not an emotive rejection of it. *See*, Sri Aurobindo, CWSA, 1997, Vols. 23-24, 632, 642. *See also*, Sri Aurobindo, CWSA, 1997, Vol. 25, 385 (‘But there has as yet been no long intellectual preparation of a more and more dominant thought cast out by the intellectuals of the age to remould the ideas of common men, nor has there been any such gathering to a head of the growing revolt against present conditions as would make it possible for vast masses of men seized by the passion for an ideal and by the hope of a new happiness for mankind to break up the present basis of things and construct a new scheme of collective life.’) In line with that discussion, we note that such statements must be made carefully, and not, as it seemed to be the case at times, as an umbrella term to address various problems in the collective or a hesitation to enter details of a problem.

³⁸⁵ This was a view expressed by some conversants. For Sri Aurobindo’s discussion on the value and limits of reason, *see*, Sri Aurobindo, CWSA, 1997, Vol. 31, 11-19. Pertaining to our discussion, Sri Aurobindo notes: ‘There is no reason why one should not receive through the thinking mind ... The thinking mind is as capable of receiving ... since it has to be transformed ... it must be trained to receive.’ 13. For his application of this discussion to problems of collective organization, *see*, Sri Aurobindo, CWSA, 1997, Vol. 25, Chs. XI-XIII, XIX, XX.

³⁸⁶ Sri Aurobindo, CWSA, 1997, Vols. 23-24, 283.

³⁸⁷ Sri Aurobindo, CWSA, 1997, Vols. 23-24, 64.

³⁸⁸ This naturally requires a far deeper examination. *See*, Sri Aurobindo, CWSA, 1997, Vols. 23-24, 633-739.

belief, absent direct experience, is to miss the mark (and risk in some cases punditry or religious ossification). This key movement, central to Auroville's public culture and indeed its governance, is considered in *Savitri*.

A fuller discussion is beyond our scope, but we may point to the direction of the advance. *Savitri* points to the limits of discursive reason, a not lightly accepted advance on the entrenched and invaluable tradition of rationalism of our times: the realization lies 'not on the luminous peaks of summit Mind', but 'hides in its light of shimmering secrecies':

Her gossamer word-webs of abstract thought,
Her segment systems of the Infinite,
Her theodicies and cosmogonic charts
And myths by which she explains the inexplicable.
At will she spaces in thin air of mind
Like maps in the school-house of intellect hung,
Forcing wide Truth into a narrow scheme,
Her numberless warring strict philosophies;

Valuing a 'strong intellectuality, at once austere and rich, robust and minute, powerful and delicate, massive in principle and curious in detail',³⁸⁹ Sri Aurobindo records the importance of mental labour in raising the foundations for spiritual seeking, in both its analytic and critical functions, as a necessary intervening stage between the 'infra' and 'supra' rational states. Reason exceeds the vital, yet is exceeded by the spirit. In the following passage from *Savitri*, he highlights the limits of reason, ending at best in a rational agnosticism that is *in itself* unable to either verify or disprove spiritual truths:

An inconclusive play is Reason's toil.
Each strong idea can use her as its tool;
Accepting every brief she pleads her case.
Open to every thought, she cannot know.
The eternal Advocate seated as judge
Armours in logic's invulnerable mail
A thousand combatants for Truth's veiled throne
And sets on a high horse-back of argument
To tilt for ever with a wordy lance
In a mock tournament where none can win.
Assaying thought's values with her rigid tests
Balanced she sits on wide and empty air,
Aloof and pure in her impartial poise.
Absolute her judgments seem but none is sure;
Time cancels all her verdicts in appeal.³⁹⁰

The faith-inspired push ahead to supra-rational, spiritual seeking beyond belief and philosophy, to arrive at experience and identification, is the defining movement:

³⁸⁹ Sri Aurobindo, CWSA, 1997, Vol. 20, 8.

³⁹⁰ Sri Aurobindo, CWSA, 1997, Vols. 33-4, 252, 694.

Happy are men anchored on fixed belief
 In this uncertain and ambiguous world,
 Or who have planted in the heart's rich soil
 One small grain of spiritual certitude.
 Happiest who stand on faith as on a rock.
 But I must pass leaving the ended search,
 Truth's rounded outcome firm, immutable
 And this harmonic building of world-fact,
 This ordered knowledge of apparent things.
 Here I can stay not, for I seek my soul.³⁹¹

What Mother and Sri Aurobindo held out as the ideal was to use these methods as stepping stones (except for the rare few, who can jump) to that which exceeds them, the supra-rational Good, Beauty and Truth – to justify ethical action, the Good, aesthetic expression, the Beautiful and intellectual seeking, the Truth, in conduct and experience, not statements of belief or unvalidated faith: the need to ‘search, test, prove, inquire, discover.’³⁹² Disagreements in the public space – in the planning domain, manifestation of the Galaxy, as elsewhere, discussed variously in Parts I-III – may be softened, if not resolved, if this searching, experiential orientation is adopted in Auroville’s public culture. Our scope is limited here, but it would an exciting research project to tease out the implications of this move on modes of governance practices, in particular, how one may illumine the ethic of collective rationality and public reasoning central to democratic systems in the micro-workings of the Residents’ Assembly General Meetings, Working Groups, meetings of sub-zonal bodies etc. Mother’s ideal of illumined decision-making in collective matters rests on this epistemic shift, from rational to supra-rational forms of knowing. This requires either a collective advance to that stage, or a voluntary submission to others possessed of that insight, inconsistent with an assertion of participatory equality. Equally, as we discussed in Part I.B, if attempted prematurely in a rash substitution of mentality for vital subjectivism, it is perilous.

To conclude, we note that this task – of securing a public culture attuned to deep engagement with Mother and Sri Aurobindo’s thought – is particularly important today as time passes and the pioneer generation that was inspired by Mother’s direct touch and physical presence gives way to those with some distance. This has led, in some accounts, to a waning of the intensity witnessed in the early years, a natural and unsurprising state given Sri Aurobindo’s cautionary note:

A religious movement brings usually a wave of spiritual excitement and aspiration that communicates itself to a large number of individuals and there is as a result a temporary uplifting and an effective formation, partly spiritual, partly ethical, partly dogmatic in its nature. But the wave after a generation or two or at most a few generations begins to subside; the formation remains. If there has been a very powerful movement with a great spiritual personality as its source, it may leave behind a central influence and an inner discipline which may well be the starting point

³⁹¹ Sri Aurobindo, CWSA, 1997, Vols. 33-4, 252, 499.

³⁹² Sri Aurobindo, CWSA, 1997, Vol. 25, 252, 16. *See*, Sri Aurobindo’s careful distinction between faith, belief and conviction in his Letters on Yoga. Sri Aurobindo, CWSA, 1997, Vol. 29, 88.

of fresh waves; but these will be constantly less powerful and enduring in proportion as the movement gets farther and farther away from its source.

Institutions are created which are supposed, but too lightly supposed to embody that spirit and the fact that the ideal is held, the fact that men live under its institutions is treated as sufficient. The holding of an ideal becomes almost an excuse for not living according to the ideal; the existence of its institutions is sufficient to abrogate ...³⁹³

To maintain that pioneering intensity of the early years with time is not an easy task, but one that is imperative. Revi astutely notes:

Many cities, temples and monuments have been built in history to symbolize, mirror or amplify the power of a sacred geometry and an aspired timelessness. Most have quickly returned to the dust that they were built from. Others have become ossified shadows of the aspiration that created them.³⁹⁴

Investment (of funds, time and energy) into developing a public sphere, a vital lifeworld, that encourages a seeking engagement with Mother and Sri Aurobindo's thought and as importantly, of others, in the practical context of city problems is an irreducibly *public* good – its spatial and cultural continuity must be secured independent of the inevitable ups and downs of individual itinerance and momentary shifts of public opinion. Building a town, as Schmidt notes, 'is a process that extends over a long time.'³⁹⁵ The question is:

What enduring principles, what 'anchoring course of logic' ... can be established in Auroville, that are strong enough to gain the endorsement and loyal compliance of future generations?³⁹⁶

It is to develop this 'anchoring course of logic' that Mother, Anger, Raz and others, all in their own way, point to a vibrant public space as necessary to secure the ideal of collective, and not just individual, freedom against unbecoming elements or the best-avoided need for rule enforcement.

*

³⁹³ Sri Aurobindo, CWSA, 1997, Vol. 25, 262-4.

³⁹⁴ Revi, 2007, 7.

³⁹⁵ Schmidt, 2003, 1.

³⁹⁶ Schmidt, 2003, 1.

PART V
AUROVILLE FOUNDATION ACT, 1988: INTERPRETIVE SCHEME

When I am not here, what will you do?

Mother, *Agenda*, 1st June, 1972

*And parts of living that belied the whole
But, pieced together, might one day be true.*

Sri Aurobindo, *Savitri*

The Auroville Foundation Act, 1988 ('the AVF Act') is a *sui generis* legislation, which creates a statutory umbrella for Auroville's internal governance with a novel, hybrid form of 'internal' democracy amongst Auroville residents with an 'external' checks and balances system. It does so through a scheme of distributed powers across three bodies, the Governing Board, the International Advisory Council and the Residents' Assembly. In this Part, we examine the history, text and purpose of the AVF Act to understand the governance structure as distributed between these three statutory bodies. **Section A** outlines the history and origins of the AVF Act in the conflict with the Sri Aurobindo Society. **Section B** examines the drafting history of the 1980 Act, the precursor to the AVF Act. **Section C** discuss the structure and scheme of distributed powers in the AVF Act. **Sections D** offers a purposive interpretation of the AVF Act to resolve the tension between the spiritual substance of the Charter and the legal form of the AVF Act, relying on (i) Mother's guidance on Auroville's governance, (ii) the legislative or authorial intention of the drafters, (iii) Sri Aurobindo's *Ideal of Human Unity*, (iv) comparison with analogous legislations and (v) post-legislative administrative practice. **Section E** considers uncertainties in past and current administrative practice in this light and offers suggestions for reform. **Section F** concludes by considering the need for mutuality amongst the three pillars of the AVF Act to secure Auroville's political ideal.

We are given to understand that matters concerning the interpretation of the AVF Act in relation to certain administrative actions are pending before the High Court of Judicature of Madras in Writ Petitions Nos. 14707/2022, 13970/2023 and 12980/2023. Since these matters are *sub judice*, we limit our discussion to the general scheme of interpretation under the AVF Act. We note that this disagreement has attracted considerable attention in the national and international media, denting Auroville's image.¹ Such matters are preferably dealt with internally in a spirit of goodwill and cooperation amongst members of the community, with external escalation as the ideally unnecessary last resort. Our proposals in Part IV suggest an internally constituted and tiered dispute resolution mechanism to that end.

¹ See, for example, Guardian, 2022, Disegno 2021, Hindu, 2022a; Hindu, 2022b; Hindu, 2023; Times of India, 2021; Times of India, 2023; National Herald, 2022.

A. HISTORY AND ORIGINS: CONFLICT WITH THE SRI AUROBINDO SOCIETY

i. *The Passage of the 1980 Act*

The history of the AVF Act has been recounted in previous literature.² Briefly, the Act was preceded by the Auroville (Emergency Provisions) Act, 1980 ('the 1980 Act'), which was occasioned by the conflict between certain residents of Auroville and the Sri Aurobindo Society, the legal vehicle created by the Mother, of which She was the President, for the administration and collection of funds of Auroville at its inception. As a letter signed by the Mother notes: 'At the summit of the organization is The Mother, who is also the President of the Sri Aurobindo Society and will guide the work of the whole organization.'³

After Mother's passing, perhaps unsurprisingly, succession disputes arose as to the control of the Sri Aurobindo Society. The Society was constituted under the West Bengal Societies Registration Act, 1961, which required a named 'Governing Body', and 'formal head' – the President – in whom the 'management of its affairs is entrusted'.⁴ This 'governing body', in whom the lands of Auroville were vested, and hitherto all planning activities were concentrated, had, under the 1961 Act, exclusive control over the developing project. A conflict of visions ensued – between exclusive control by the Society and its governing board on the one hand, and decentralized control by the residents of Auroville on the other – ensued. The details of the conflict between the residents and the management of the Sri Aurobindo Society have been recorded and debated elsewhere – while historically important, they are not necessary for our purposes here.⁵ We may note though that this power-struggle disrupted work on the ground, with law-and-order concerns raised on both sides, and sizeable emigration.⁶ The following excerpt from *Contributions* in 1980 provides an example of the day-to-day disruptions caused by the dispute:

There is a lot of work to do in Matrimandir now: - to remove the old wooden tower, useless for the next phases of the work and dangerous because it's rotten; to store this wood, which will be needed for the construction of the sphere; - to build the new crane to lift the precast beams (two months' job in the workshop); - to continue to precast the beams for the sphere; - to complete the shutterings for the concretings of the first ringbeam of the sphere; - to start the ferrocement cover on the pipe structure of the ramps. For all this huge work that is ready to be done there are only 15-20 people working there daily. It is not easy, it is not simply a physical work; one has to

² See, Bernard, 2010; Mukherjee, 2019. Mukherjee's opinions seem to colour his narration of the historical record, but his work helpfully collates relevant documents in annexures to the book.

³ Ford Foundation Letter, 1969.

⁴ See, West Bengal Societies Registration Act, 1961.

⁵ See, for example, Mukherjee, 2019; for the contrary view, see, Bernard, 2010. It is worth noting that this time was a major setback for development work in Auroville. Records from the time record the pernicious distrust that seeped in the community. Importantly, Anger, put in charge by Mother, left in this time: 'Roger Anger, faced with the responsibility of manifesting the City as envisaged, became increasingly frustrated with the situation. To avoid getting drawn into the power struggle that was then enveloping the township and its residents, he resigned from the main organizing committee in 1975 and ultimately left for France in 1976 ...' Ciconesi and Ciconesi, 2012, 2-3.

⁶ See, Thomas and Thomas, 2013, 70.

bear the tension of the inner battle, we hope the last Auroville battle, against the forces that want to suffocate it.

Now the Matrimandir workers realise the impossibility of going on in the work without a complete clarification with the claims of the Sri Aurobindo Society:

‘The ownership of the Matrimandir is vested in the Sri Aurobindo Society ...’

‘... you are not cooperating with the Society or obeying its order. This is tantamount to gross indiscipline.’

‘... You are given a month’s time to vacate the house allotted to you for residence in Auroville ...’

‘You are hereby relieved from all or any job assigned to you in Auroville.’

(From letters of the Sri Aurobindo Society of 17 October and 26 September 1979, directed to Piero Ciconesi, the architect of the Matrimandir.)

The SAS again pretends to be entitled to the absolute obedience and total surrender of Aurovilians. But it is only to Mother and Sri Aurobindo that we will submit and to no human beings or institutions. The surrender is a free choice and not an imposition or something that can be obtained with the help of law and the police.⁷

In 1980, Parliament nationalized properties vesting in the Society based on the report of the Government of India-appointed Kulkarni Committee, which ostensibly discovered instances of financial irregularity and mismanagement in the accounts of the Society.⁸ This was done with the following intention stated in the short Preamble:

An Act to provide for the taking over, in the public interest, of the management of Auroville for a limited period and for matters connected therewith or incidental thereto.

...

AND WHEREAS in view of the serious difficulties which have arisen with regard to the management of Auroville. it is necessary to take over, for a limited period, the management thereof and any delay in taking over the management of Auroville would be highly detrimental to the interests and objectives of Auroville.⁹

The 1980 Act, thus, was envisaged as an interim measure for the management of Auroville, for a ‘limited period’ of two years, extendable up to five (later eight) years under Section 3. Section 5 of the 1980 Act tasked an ‘Administrator’ to ‘carry on the management of Auroville for and on behalf of the Central Government’, with the provision, in Section 8, that the management of Auroville may be relinquished back to the Governing Body of the Sri Aurobindo Society, if the underlying reasons for the nationalization were voided. The purpose behind the Act, as it appears from the text, was to provide space for the development of appropriate governance mechanisms after Mother’s passing, and not to institute a permanent takeover. Interestingly,

⁷ Contributions, 1980.

⁸ See, Mukherjee, 2019. The findings of the Committee were not placed before Parliament despite repeated requests by members. The Report, reproduced by Mukherjee, in itself is short and summary, and does not contain details.

⁹ Contributions, 1980, 14.

Section 6 of the 1980 Act constituted an ‘Auroville International Advisory Council’ to advise the Central Government on an appropriate resolution for Auroville’s governance, such that ‘the members of Auroville are allowed freedom to grow and develop activities and institutions for the fulfilment of the aspirations and programmes envisaged in the Charter of Auroville.’

ii. *Constitutionality of the 1980 Act: SP Mittal v. Union of India*

The constitutionality of the 1980 Act was challenged by the Sri Aurobindo Society before the Supreme Court in *SP Mittal v. Union of India*, on several grounds, most notably the freedom granted to religious institutions under Articles 25 and 26 of the Indian Constitution.¹⁰ The Supreme Court dismissed the challenge – while the reasoning behind the Court’s judgment is not necessary for our present purposes, it is relevant to note the Court’s *obiter dicta*:

Keeping in view the international character of the project and considering the government’s involvement in actively sponsoring the project through UNESCO, the growth and management of the project had become the primary responsibility of the Government of India. The ideals of the project formed India’s highest aspirations, which could not be allowed to be defeated or frustrated. Sri Aurobindo Society had lost complete control over the situation and the members of the Auroville approached the Government of India to give protection against oppression and victimisation at the hands of the said Society ... The Government in the circumstances could not be a silent spectator to the mismanagement of the project and internecine quarrels amongst its members, which if not checked could lead to the destruction of the project so nobly conceived.¹¹

Thus, the Government of India, at the request of a group of Auroville residents, took an active oversight, though not managerial, role to preserve the integrity of the project, or Mother’s vision for Auroville, which was declared to be not just a private matter but of ‘public interest.’ This marks an important shift in the public, or governmental, view of Auroville’s management. Subsequent to the judgment of the Supreme Court in 1982, the 1980 Act was extended four times. As the Statement of Objects and Reasons notes:

Though the management vested in the Central Government in 1980 till the Supreme Court upheld the validity of the Act in November 1982, the Act could not be brought into operation in full. In order that the progress registered between 1982 and 1985 could be further consolidated and since earnest efforts were being made to place the management on a sound footing, the Act was amended in August 1985 so as to extend the period of the Act for a further period of two years beyond 9th November, 1985.

After urgent administrative aspects were attended to, the Auroville International Advisory Council constituted by the Central Government under section 6 of the Auroville (Emergency Provisions) Act, 1980, had its Sixth Meeting at Auroville in August, 1986, and initiated efforts to arrive at a solution, in consultation with the concerned parties (residents of Auroville and Sri Aurobindo Society), to provide for a permanent arrangement for the management of Auroville.

Efforts have continued since then, and although some progress has been achieved, no satisfactory formula has finally emerged as yet. It is felt that some more time would

¹⁰ *SP Mittal v. Union of India*, 1983.

¹¹ *SP Mittal v. Union of India*, 1983, per Misra J.

be needed to allow for the continuance of these efforts and until then the management of Auroville should be carried on as per the Auroville (Emergency Provisions) Act. As the term of the Auroville (Emergency Provisions) Act expires on the 9th November, 1987, the President promulgated the Auroville (Emergency Provisions) Amendment Ordinance, 1987 on the 28th October, 1987, to continue the period of management for a further period of one year.¹²

The 1980 Act was thus a temporary ‘takeover’, not with the intention of permanently vesting the management of Auroville in the Central Government but with a view to arriving at a negotiated settlement between the members of the Sri Aurobindo Society and residents of Auroville. In this process, various proposals were discussed, including co-opting residents of Auroville as members of the Sri Aurobindo Society to create a power-sharing agreement,¹³ the registration of an independent society by seven residents of Auroville (‘Auroville Society’), ‘to create an independent legal body for Auroville, which could receive funds independently and offer the opportunity to develop a new internal organization for Auroville’ etc.¹⁴ None of these efforts came to fruition.

*

¹² Statements of Objects and Reasons, Auroville (Emergency Provisions) Act, 1980.

¹³ Bernard, 2010, 14-15.

¹⁴ Mukherjee, 2019.

B. DRAFTING HISTORY OF THE 1980 ACT

The 1980 Act, which confirmed a Presidential Ordinance, witnessed vigorous and detailed debates on the floor of the Lok Sabha. In generally accepted canons of legal interpretation, the drafting history of a legislation, particularly legislative debates preceding its enactment and the statement of the Minister introducing the Bill, are important, though not conclusive, guides in the correct interpretation of an act. Accordingly, a reference to the debates in the Lok Sabha is instructive in understanding the 1980 Act, and its successor, the 1988 AVF Act.

i. A 'Temporary Takeover'

The 1980 Bill was introduced by Mr. Chavan, Minister of Education and Social Welfare. Mr. Chavan, responding to apprehensions that the Government was taking over a private body, the Sri Aurobindo Society, whether understood in cultural or religious terms, noted that the 'Government has been motivated solely by the idea of securing proper management in public interest and nothing else ...'¹⁵ He clarified this ambiguous formulation – 'securing proper management in public interest' – with the following statement: that 'the Bill brings out clearly that the Government's function will be that of a protector of the members of Auroville'.¹⁶ He noted that:

Our entire emphasis is upon the fulfilment of the ideals of Auroville, and the Government is determined to help the members of Auroville in giving them the freedom which is necessary for them to work out the programmes which have been envisaged in the Charter of Auroville ... This provision will ensure that nobody is allowed to work in such a way as to disturb the freedom of the members of the Auroville or that might tend to be an obstacle to the fulfilment of the programmes envisaged in the Charter of Auroville.¹⁷

The Government's intention in introducing the 1980 Act was thus to limit external interference with the residents of Auroville. It was a limited 'takeover', carefully structured to secure interim management till matters were resolved by the parties involved. The Act wisely left open the possibility of a negotiated settlement of the 'power-struggle', as one member put it, between Sri Aurobindo Society and the residents of Auroville.¹⁸ Some members disagreed on the veracity of claims made against the Sri Aurobindo Society and where the blame lay. Some referred to 'anti-national' and illegal activities, with one member noting that Auroville had turned into 'a haven for hippies and a sanctuary for the dropouts.'¹⁹ While these were individual sentiments, there was a consensus that the unfortunate situation was a far cry from Mother's noble ideals. The debate centred around whether it was wise for the Government to '[want] to hold the baby for a period of two years.'²⁰

¹⁵ Rajya Sabha Debates, 1980, 337.

¹⁶ Rajya Sabha Debates, 1980, 337.

¹⁷ Rajya Sabha Debates, 1980, 338.

¹⁸ Rajya Sabha Debates, 1980, 350.

¹⁹ Rajya Sabha Debates, 1980, 367. This view is also expressed by two members during the debates in the Rajya Sabha on 19th August 1985 during the passage of the Auroville (Emergency Provisions) Amendment Bill, 1985.

²⁰ Rajya Sabha Debates, 1980, 363.

Remarks made by Dr. Singh, one of the primary interlocutors in the debate, and later Chairman of the Governing Board of the Auroville Foundation, capture this general sentiment:

After the Mother passed away, the whole structure, the inner spiritual magnet as it were which held Auroville together began to fall apart. I do not want to go into the sordid story of how the dream of the Mother became the nightmare that we see today.

On both sides, there have been failings. I do not want to apportion the blame to any particular individual or any particular group. If the Aurobindo Society is sought to be run by one individual as a personal empire, there have also been failings on the part of Aurovilians. Many Aurovilians have not acted upto the standard that is expected of people living in a great new city like this.²¹

Mr. Chavan, whose views as the Minister proposing the Bill bear weight as a matter of legal interpretation, recognized this quarrel and the ensuing difficulty in handing over exclusive control to either side.²² While he was unequivocally against the claims of the Sri Aurobindo Society to unilaterally dictate Auroville's development, he was equally apprehensive of the alternative of handing over the reins to any particular group of Auroville residents:

The quarrel started when the office-bearers of the Society started dictating these inhabitants by saying: 'You have to obey the orders of the society.' They said, 'We are not going to obey any body's orders. We have come here: we want to live as free citizens. If there is anything, certainly, you can tell us. If we are convinced about it, certainly, we will do it' ... I am aware of the fad that there is factionalism in Auroville; there are two factions fighting each other. We do not propose to hand over this Auroville to them.²³

The concern, in essence, was two-fold. First, to establish a governance mechanism that comported with Mother's vision, enshrined in the Charter's *dicta* that 'Auroville belongs to nobody in particular'. This presented a unique problem, for there was an apparent tension between this noble ideal of the 'Divine anarchy', infused with spiritual meaning, and the legislative requirement to name a singular named body that could be responsible for the management of lands and assets vested in the Sri Aurobindo Society. This was also Professor Joshi's understanding in drafting the AVF Act, successor to the interim protection legislated in the 1980 Act:

Now it is understood that Auroville belongs to no one from the human plane, but it does in fact belong to the Divine, and must run in accordance with the authority of the Divine. At this point, it is still mind-boggling for the conditioned, unopened mind to try to make sense of an invisible authority. After Mother's parting, the issue of authority and ownership became prominent. Just like the human mind often cannot fathom an invisible owner, so could the law not allow a land to be held without appropriate ownership. In the early beginning of Auroville, the lands bought as an offering to the Divine was transferred to Sri Aurobindo Ashram, which was a registered society under the direct guidance and leadership of the Mother, upto 1973. Circumstances led to there being a rift between the people of Auroville and the Society, and Ashram. This unresolved misunderstanding stood in court for almost

²¹ Rajya Sabha Debates, 1980, 370-1.

²² See, in general, Barak, 2007.

²³ Rajya Sabha Debates, 1980, 401.

seven years after which the Government of India decided that the only way to resolve the situation was to create a special Act of the Parliament. This Act was implemented for the purpose of carrying out the Divine vision, Mother's Auroville. The Charter of Auroville was made an essential part of the Act that nobody could abrogate. The problem of ownership of the land was still in question, because by law, the land had to be held by either a private organization, a public trust or a religious body. In this light, the government decided on the Foundation Act (governed by the Charter of Auroville), where all Auroville land that belonged to the Society was now transferred to and vested in the Foundation. As per this Act, full freedom can be exercised provided it is within the confines of the Charter and the vision defined for Auroville by the Mother.²⁴

The crux of the matter, indeed the seed of all governance problems in Auroville, was how the void left by Mother's passing could be filled. Her authoritative physical presence and direction, which acted as the final arbiter in all disagreements, big and small, now required a collective aspiration. It was regrettable, but perhaps inevitable, that conflicts kept at bay under Mother's guidance in the physical would surface after Her passing. In a cryptic remark in a conversation dated 17 January 1970, Mother anticipated this state of affairs:

You just have to imagine I were gone ... Just imagine that and you'll see, you'll soon see what will happen.²⁵

Two years later, on 12 March, 1972, she went further:

I can see, I have truly the occasion to see that if I left, I have nobody here, it would be our destruction.²⁶

Dr. Singh voiced this concern during the debate:

I had feared all along, even when she was alive and when I went there, I would ask the organisers, 'What is going to happen after the Mother passes away?' It was a question to which I received no satisfactory reply.²⁷

The second concern was to identify precisely the government's role in Auroville: whether a limited and time-bound role as a referee, with powers of oversight and monitoring amidst competing visions, or a more engaged and positive role to ensure the fulfilment of Mother's dream through the course of the project.

Mr. Unnikrishnan, a member who opposed the passage of the Bill, articulated the problem well:

I would like to say that he [the Minister] will be watched not merely now as to how he would proceed and what he would do with the management of Auroville but also what steps he would take for the fulfilment of the great dream. Would he hand it over to a section or he would take the cooperation of everyone, the maligned one and those who are not maligned and those who are interested in the teaching of The Mother?²⁸

²⁴ Auroville Tomorrow, July, 2022, 9.

²⁵ Guigan, 2018, Vol. 2, 52.

²⁶ Guigan, 2018, Vol. 2, 334-5.

²⁷ Rajya Sabha Debates, 1980, 370.

²⁸ Rajya Sabha Debates, 1980, 362.

Several members voiced their opinions on both questions. Whilst one group of members urged the Government not to take Auroville over 'as a governmental institution', others proposed a more robust engagement for the fulfilment of this project of international importance. Two members, Mr. Rajda and Dr. Singh, offered a *via media*. Mr Rajda noted:

Because, there are two groups and naturally there is cutthroat competition and neck and neck fight is going on. Some persons who can take a detached view, a dispassionate view, who would not take sides, they should be asked to set things right. From this point of view. I would request [the Government] not to take it over as a governmental institution because it would be a retrograde step. You can find a *via media* through which you can monitor the affairs and cleanse the Augean Stable. I would like the Government not to take over the entire Auroville, the management and everything but to monitor it through some body, which would set things right.²⁹

Dr. Singh resolved the contradiction – between the necessary freedom for Auroville residents and governmental intervention mandated by internal conflicts borne of that freedom – in the following way:

I see no inherent contradiction provided – and always provided – that the Government is quite clear in its mind that this is not to be made an extension of the Education Ministry, that some Deputy Secretary, sitting in that very distinguished Bhavan where I also sat as a Minister, will become the final arbiter of everything that may happen.

I had personally suggested a broader-based Committee consisting of representatives of the Ashram, of the Society, of the Aurovilians, Members of Parliament and the Governments of Tamil Nadu and Pondicherry, because a lot of things are involved; land acquisition is involved, citizenship problems are involved, financial problems are involved, and so on. But they have, in their wisdom, suggested only a five-member Advisory Committee. I presume that this is only going to be an apex Committee and that it will have full authority to set up such other bodies and committees as may be necessary for the smooth running of Auroville, on the lines envisaged by the Mother and in the light of the teachings of Sri Aurobindo. This is an assurance which, I think, will go a long way in satisfying all those people who, though genuinely fed up with the present situation, are nonetheless afraid of Government intervention.

There was no other way to pry this great project loose from the iron control of people who were running it as if it was their personal fief. I have come to the conclusion that there is no other way to break the present deadlock of what can only be called 'disharmonious, undivine forces', to have a clean breakthrough and, hopefully, to move towards a new orientation.³⁰

In reply, Mr. Chavan was clear that the Administrator's role, with the advice of the International Advisory Council, was limited to financial auditing and the like and did not extend beyond:

His [the Administrator's] job is going to be to correct the accounts, that the work which has been completely stopped and thereafter come to the greater ideal which Dr. Karan Singh is putting forth. We will have to discuss that with him. At least in the Bill there is nothing of that nature. We would like to be advised by him as to what he

²⁹ Rajya Sabha Debates, 1980, 391.

³⁰ Rajya Sabha Debates, 1980, 372.

has to say in the matter. At the same time, I do not know how far the Government will be able to come to the expectations which Dr. Karan Singh has expressed here. We can keep proper accounts; we can do proper auditing.³¹

Ultimately, it was on this understanding that the 1980 Act was passed by the Lok Sabha, as a reluctant, constrained and necessary intervention to create the space for an internal resolution of the problem amongst those connected with Auroville, which would allow for the relinquishment of the Central Government's temporary 'takeover'. Unfortunately, no such consensus solution 'to set things right' amongst those involved was found, despite multiple extensions of the two-year period.

ii. Continuation of the 'Temporary Takeover'

Several members noted the lack of an amicable solution during the debate in the Rajya Sabha on the passage of Auroville (Emergency Provisions) Amendment Act, 1985, which extended the application of the 1980 Act beyond the initial five-year period. The extension, as Ms. Singh put it, was to 'give a boost to the experiment' given the good work conducted on the ground in the interim:

Now, during the last three years from 1982-85 a lot of progress has been made. I may just give you a few items. A major programme in afforestation has been undertaken and nearly 14 lakh trees have been planted. Bharat Niwas is making progress. An international seminar with 200 delegates was held in February this year to celebrate the International Youth Year. Rural health and nutritional programmes were initiated and developed, and they have good results. Sri Aurobindo International Institute of Educational Research was founded in 1984, which is doing very good work. The Centre for Scientific Research was inaugurated in January 1984. A National Seminar on International Understanding was held in August 1984, and a lot of papers were read and a lot of new ideas came out of that. Cultural programmes in music, dance, drama and arts were hosted as well as educational exhibits were shown. UNESCO has sponsored certain exhibitions like 'Learning To Be'. Teachers training materials are under production for the country. Architectural innovations are under experiment. Organic farming without the use of harmful use of chemicals as well as drip irrigation are being demonstrated which are given increased and better yields.³²

This view was echoed subsequently by the first International Advisory Council constituted under the 1980 Act, at its second meeting on 23rd August 1986:

The international township known as 'Auroville' located in South India has, in spite of a difficult period through which it passed during the last several years, emerged as a unique collective experiment ... We are grateful that the Governing of India has intervened in 1980 to give the necessary protection and encourage to the residents of Auroville in continuing their tasks of building Auroville and its growth through progressive collective experiments.³³

Alongside, reminding the minister that the 1980 Act was an interim measure, two members, Mr. Babul Reddy and Mr. Satyanarayan Reddy, advised the Government to bring the takeover

³¹ Rajya Sabha Debates, 1980, 403.

³² Rajya Sabha Debates, 1985, 356.

³³ First International Advisory Council, 1986, 5.

to an early end to avoid a creeping nationalization.³⁴ Another member, Mr. Mitra, urged the Government ‘to think seriously of having a permanent set-up for this project’ given the ‘tremendous progress [that] has been made’.³⁵ Sensing the general mood of the House in favour of the Bill, a fourth member, Mr. Jaswant Singh, attempted to ‘venture where angels fear to tread’:

When it is a question of putting into practice such an ennobling vision, then, for the Government to arrogate to itself both the comprehension of that vision and the ability through bureaucrats to be able to put it into effect, is a question which is seriously open to doubt.

I do, in the same vein like to submit, Sir, that whereas I say that the Government is not intrinsically capable of exercising such functions in like manner, no single person or individual can claim himself or herself to be the sole legatee of such an ennobling vision.³⁶

The Minister proposing the Bill, Mr. Pant, reiterated the Government’s commitment to evolve a solution ‘in which those who live in Auroville can ultimately take over the responsibility of running it.’ He noted:

I agree with Mr. Reddy ... and other friends, who say that one should work towards a permanent solution ... But nobody ... came with forward with any viable alternative ...³⁷

This lack of an alternative is unsurprising given all corporate forms that could have been availed at the time, whether as a trust, society or not-for-profit private limited company, would operate by way of a singular, named body possessing exclusive powers of management.³⁸ None could accommodate an assembly. This required the unlikely event (then as now, we may add) of few named individuals being acceptable to the entire community. A simple change in institutional mechanisms would thus not provide a permanent answer to the power-struggles witnessed in that period, but simply shift the scene of the battle. Professor Joshi pointed to this concern:

...there is a Company Act, there is Societies Registration Act, you will find that in these Acts the forms of organisation are already laid down and you can’t escape from that. If you have a Society Registration Act you will see that there shall be such and such governing body which shall be elected and there are many rules under which election will take place in one form or the other. Everything is straight jacketed. You have no freedom at all to organise in the way in which you want ...³⁹

³⁴ Rajya Sabha Debates, 1985, 357-9, 379.

³⁵ Rajya Sabha Debates, 1985, 357-9, 365-6.

³⁶ Rajya Sabha Debates, 1985, 357-9, 369.

³⁷ Rajya Sabha Debates, 1985, 357-9, 382.

³⁸ According to Guigan, the Rules and Regulations of the Sri Aurobindo Society, subject to change, required that for any proposal to become effective, it was to be approved by its President, the Mother. *See*, Guigan, 2018, Vol. 2, 93. Unless these regulations were changed, any negotiated settlement would concentrate power in the President. This presented obvious problems. We do not know if any attempts were made to amend the regulations to incorporate an assembly-like structure, which may have been a creative way to resolve the problem without governmental intervention. Mother had put into practice the creation of autonomous groups within the Sri Aurobindo Society, as for example with Auromodèle. *See*, Guigan, 2018, Vol. 1, 337.

³⁹ Joshi, 1999, 27.

For this, a *sui generis* legal scheme, capable of concretizing Mother's ideal that 'Auroville belongs to nobody in particular' was required. As we note below, the passage of the AVF Act was an attempt, indeed the first in Indian legal history to the best of our knowledge, at doing precisely this.

*

C. STRUCTURE AND SCHEME OF DISTRIBUTED POWERS UNDER THE AVF ACT

After nearly eight years and repeated failed attempts at reaching a settlement between the Sri Aurobindo Society and the residents of Auroville, the Government decided, albeit reluctantly, to establish a *permanent* statutory machinery for Auroville's governance, by way of the 1988 AVF Act.

i. Structure of the AVF Act

The AVF Act established an independent legal entity, the Auroville Foundation, to manage the affairs of Auroville. To avoid making Auroville a 'government department', as all members agreed in the discussions of the 1980 Act, a new and autonomous structure was required. Alain Bernard, whose testimony reliably speaks to the events surrounding the passage of the AVF Act, quotes Narasimha Rao, previously Minister for Human Resources Development and a member of the International Advisory Council under the 1980 Act:

As these people are not able to come to terms, we shall create a governing board composed of independent people, neither SAS or Aurovilians. This idea of Narasimha Rao was in fact an important element in the solution. Kireet felt it was like a breakthrough.⁴⁰

This radical solution, to create an independent governing board, was Parliament's effort at handing over Auroville to 'nobody', whilst tilting towards the autonomy of Auroville residents to run day-to-day affairs. This is confirmed by the third preambulatory paragraph, which notes: 'the residents of Auroville have also carried on activities for the development of Auroville which need further encouragement and consolidation.' Thus ending the 'takeover', the Government partially held true to its intention to transfer responsibility to 'those who live in Auroville'.

The AVF Act created three bodies, the three equal pillars of the Auroville Foundation: a Governing Board (whose powers may be delegated to the Secretary), an International Advisory Council and a Residents Assembly (assisted by its Working Committee).

Section 7 of the Act notes, in broad and plenary language, that the 'general superintendence, direction, control and management of the affairs of the undertakings, the right, title and interest' in relation to the Sri Aurobindo Society – which comprised all lands and tangible assets acquired by the Society – shall be vested in the Auroville Foundation. The responsibilities each of the three pillars of the Foundation are identified in turn. Before we address the relative placements of these functions, a brief outline is helpful.

First, the powers of the Governing Board are provided in Sections 11, 16 and 17 of the AVF Act. The Governing Board comprises not more than seven persons of eminence in fields that are in the areas of Auroville's work, and two representatives of the Central Government. Section 11(3) further vests all powers vested in the Foundation in the Governing Board, whose responsibility is outlined again in plenary language: the 'general superintendence, direction

⁴⁰ Bernard, 2010, 38.

and management of the affairs of the Foundation shall vested in the Governing Board.’ This power is detailed out in Section 17:

(a) to promote the ideals of Auroville and to coordinate activities and services of Auroville in consultation with the Residents’ Assembly for the purposes of cohesion and integration of Auroville; (b) to review the basic policies and the programmes of Auroville and give necessary directions for the future development of Auroville; (c) to accord approval to the programmes of Auroville drawn up by the Residents’ Assembly; (d) to monitor and review the activities of Auroville and to secure proper management of the properties vested in the Foundation under section 6 and other properties relatable to Auroville; (e) to prepare a master-plan of Auroville in consultation with the Residents’ Assembly and to ensure development of Auroville as so planned; (f) to authorise and coordinate fund-raising for Auroville and to secure proper arrangements for receipts and disbursement of funds for Auroville.

Section 32(1) provides the Governing Board the power to issue regulations, not inconsistent with the Act, to discharge its functions. This power, however, is limited by the need for approval by the Central Government, which may make any changes it deems fit. So far as we are aware, approval has never been denied, nor has the residuary power to amend been exercised.

... no regulation made by the Governing Board shall have effect until it has been approved by the Central Government and published in the official gazette, and the Central Government, in approving the regulation, may make necessary changes therein which appear to it to be necessary.

In addition, Section 16 authorizes the Governing Board to constitute committees for the efficient discharge of its functions, and to co-opt non-voting members in such committees.

Second, the powers of the Residents’ Assembly, which comprise ‘all the residents of Auroville who are for the time being entered in the Register of Residents’, are detailed in Section 19. Under this section, the Residents’ Assembly is to ‘perform such functions as are required by this Act *and* shall advise the Governing Board in respect of all activities relating to the residents of Auroville.’⁴¹ Sub-clause (2) notes that ‘in particular, and without prejudice to the foregoing powers’, the Residents Assembly may:

(a) allow the admission or cause the termination of persons in the register of residents in accordance with the regulations made under section 32; (b) organise various activities relating to Auroville; (c) formulate the master plan of Auroville and make necessary recommendations for the recognition of organisations engaged in activities relatable to Auroville for the approval of the Governing Board; (d) recommend proposals for raising funds for Auroville for the approval of the Governing Board.

We may note here an ambiguity in the drafting of Section 19: while it requires the assembly to ‘perform such functions as are required by this Act’, with an inclusive, not exhaustive, list of functions in clause (2) ‘without prejudice to the foregoing powers’, the AVF Act does not list ‘such functions’ or indicate what the ‘foregoing powers’ are in any previous section. Section 21(4)(b), which comes after, provides some guidance: it grants residents the ‘freedom to grow and develop activities and institutions’, indicating that the general powers are broad and co-

⁴¹ Emphasis ours. The effect of the disjunctive ‘and’ in Section 19 is considered below in Section E.

terminus with all activities of Auroville, and thus intentionally unspecified. In any case, the reference in Section 19 to ‘foregoing powers’ is *ex facie* incomplete. As we consider below, incompleteness and ambiguity in statutory texts can be resolved by a purposive approach to interpretation, in this case by reference to Sri Aurobindo’s *Ideal of Human Unity*.

Like Section 16, sub-clause (3) permits the Residents’ Assembly to ‘establish such committees as it may consider necessary which shall represent it in relation to the functions to be performed by the Governing Board.’ In particular, Section 20 establishes a permanent body, the ‘Working Committee of the Residents’ Assembly’ with the twin functions of assisting the Residents’ Assembly and the Governing Board. The constitution of this Working Committee is decided exclusively by the Residents’ Assembly.

Finally, the third pillar, the International Advisory Council, comprising five members nominated by the Central Government ‘devoted to the ideals of human unity, peace and progress’ is tasked under Section 21 with the following functions:

(3) The Council may, on its own motion or on a reference made to it by the Governing Board, advise the Governing Board on any matter relating to the development and management of Auroville. (4) In tendering any advice to the Governing Board, the Council shall endeavour to secure that – (a) the ideals for which Auroville has been established are encouraged, and (b) the residents of Auroville are allowed freedom to grow and develop activities and institutions for the fulfilment of the aspirations and programmes envisaged in the said Charter of Auroville.

ii. Relative Distribution of Powers

This unique structuring represents a creative way to legislate a constitutional scheme that can scaffold, or provide an appropriate institutional form for the nebulous ideal (at least in our current state of progress) of the Divine anarchy. As Dr. Singh appealed in 1980, the Act was a way ‘to have a clean breakthrough and, hopefully, to move towards a new orientation.’⁴² On the one hand, it avoids an exclusive concentration of power in any body, with a careful system of checks and balances, thus ensuring that no single body is supreme, and on the other, assigns relatively clear functions and duties to each. Yet, there are some, perhaps unavoidable or deliberate, interpretive ambiguities which we address in the next section.

Each body under the Act is naturally required to ‘promote the ideals of Auroville.’ Beyond that, in two classes of activities under sub-clauses (d) and (f), the powers of the Governing Board are strongly worded – with respect of asset management, of properties or funds, the Governing Board is required to ‘authorize’ and ‘secure proper management.’ In three classes of activities, under sub-clauses (a), (b) and (d) the powers of the Governing Board are mildly worded – with respect to the ‘activities and services of Auroville’ and ‘basic policies and programmes’, the Governing Board is tasked with ‘promotion’, ‘coordination’ and ‘review ... with necessary directions.’ There is an overlap between sub-clauses (b) and (c), as both concern ‘programmes’, yet the relationship seems unclear: (b) requires the Governing Board to ‘review ... and give necessary directions’, while (c) uses stronger language, with a requirement that it ‘approve’ such activities. Finally, in respect of the important subject of a masterplan, the Governing Board

⁴² Rajya Sabha Debates, 1980, 373.

is required to 'prepare' a plan 'in consultation with' the Residents' Assembly and 'to ensure development as so planned' – this development would naturally relate to the programmes and policies mentioned earlier.

We can note three points in this context:

First, in relation to activities that pertain to the development and day-to-day affairs of Auroville, the residents of Auroville are naturally the primary and autonomous torch-bearers, with an oversight and review authority provided to the Governing Board. For the singularly important task of preparing the masterplan, the Residents' Assembly is required to 'formulate the master plan,' indicating its primary authority, yet with the Governing Board's final approval. This framework of a guard-railed autonomy, as it were, is confirmed by Professor Joshi and the legislative drafting history. Professor Joshi notes:

... this totality of residents has not been given any particular form of governance. Sometime some people reading from outside may feel it is a lacuna in the Act, that no form is given for the Resident Assembly. But from another point of view, it is a safeguard against imposition of any form. So you might say that there is an utter freedom given to the Residents' Assembly to experiment, to make research and to devise forms by which the divine anarchy can be realised. If the residents of Auroville know how to do it, if they ripen themselves into that consciousness, this freedom is ensured in the Act. In the meantime, there is also a provision in the Auroville Act that although there is a Governing Board which may from outside seem to be a Board which would control, superintend, supervise, intervene, supervene and you might say it is a final authority, this Governing Board is required to consult the Residents' Assembly according to this Act itself, and there are provisions in the functions of the Residents' Assembly where it is laid down that Residents' Assembly will organise all the activities of Auroville, so the scope is widest. There is not a single activity which Residents' Assembly cannot organise. As a result I find that Mother's intention that Auroville will be a field of research and particularly the concept of divine anarchy, if the residents of Auroville decide to conceive of the forms, of this form of development and organisation, it would be perfectly possible to do so within the frame-work of this entire Act.⁴³

Similarly, though the AVF Act did not witness as intense a debate as its predecessor, Mr. Shankar, the Minister of Human Resources Development who introduced the Bill, noted as follows:

As far as the day-today activities are concerned, they will be looked after by the residents through appropriate autonomous arrangements, which will include Residents' Assembly and its Working Committee. The idea underlying this arrangement is that the residents of Auroville should have autonomy so that activities of Auroville can grow under an atmosphere conducive to harmonious growth.⁴⁴

⁴³ Joshi, 1999, 8-9. As we discuss below, this leads to a natural and consciously chosen tension between the bodies in cases of deep disagreement: the 'final authority' of the Governing Board is subject to the International Advisory Council's advice and the residents' 'utter freedom'. Without any final arbiter, other than the Charter, which is open to divergent interpretations, mutuality between the bodies to arrive at a common course of action is the only practical solution.

⁴⁴ Rajya Sabha Debates, 5th September, 1988, 329-330.

Second, in respect of funds and asset management, as distinct from programmes and policies relating to the daily management and affairs, the powers of the Governing Board are strongly worded: the Governing Board is required to ‘authorize’ proposals for raising funds, which the Resident Assembly can recommend, and to ‘secure management all properties vested in the Foundation.’

Thus, aside from finance and asset management, all other responsibilities of the Governing Board are either in consultation with the Residents’ Assembly, or identify the latter as the first mover who initiates the action. The Governing Board has powers of oversight, review and monitoring with the purpose of keeping the Residents’ Assembly true to the Charter. Indeed, in the extreme, clause (c) clearly envisages the possibility of the Governing Board refusing approval to programmes drawn up by the Residents’ Assembly, even if they concern day-to-day affairs.⁴⁵ Yet, the general scheme of the Act, evinced explicitly in the text of Section 21(4)(b) and supported by the legislative history narrated above, is to grant residents the greatest available freedom to develop Auroville.

It is in this context of the relationship between the Governing Board and the Residents’ Assembly, and the possibility of disagreement, that the role of the International Advisory Council arises. The Council is required to ‘advise’ the Governing Board, and in particular to ‘secure that ... the residents of Auroville are allowed freedom to grow’ and that ‘the ideals for which Auroville have been established [under the Charter] are encouraged.’ The Council thus acts as a check on both the Governing Board and the Residents’ Assembly, the two primary decision-making authorities under the AVF Act.

*

⁴⁵ We may note here the phrase ‘in consultation with’ is subject to interpretive controversy in the context of Articles 124 and 127 of the Constitution of India, which require that judges to the High Courts and Supreme Court be appointed by the President ‘in consultation with’ the Chief Justice. A similar debate on mutuality proceeds, albeit in a markedly different context. That issue would take us off course here, but some lessons may be learnt from that literature.

D. PURPOSIVE INTERPRETATION: TENSION BETWEEN SPIRITUAL SUBSTANCE AND LEGAL FORM

The spiritual substance of Auroville, embodied in Mother's Charter, is clear: 'Auroville belongs to nobody in particular.' Yet, as a practical matter of law, lands required a named owner and decisions taken required a governance structure with assigned powers, rights and duties. In providing a legal form to this spiritual substance lay the challenge of drafting the AVF Act, 1988. To add to this, the ambiguity inherent in any legislative exercise, in this case on the relative distribution of powers as between the three statutory bodies, presents a further complication. In this section, we attempt to provide a purposive interpretation to the AVF Act, 1988 to assuage, though not resolve, this tension.

Canons of legal interpretation dictate that in cases of textual ambiguity or doubt, one must adopt a purposive approach that seeks to actualize the underlying thrust of the statute, why it was enacted in the first place, rather than a formal approach that focusses strictly on the text. As Barak, an authority on legal interpretation, notes:

The ... core component of purposive interpretation is the element of purpose (the *telos*). This is the *ratio juris*, the purpose at the core of the text ... This purpose is the values, goals, interests, policies, and aims that the text is designed to actualize.

...

The purpose of a norm has two foundations: subjective and objective purpose. The subjective purpose constitutes the values, goals, interests, policies, aims, and function that the text's author sought to actualize. This is authorial intent ... the interpreter seeks the meaning that best realizes the intent of the author. The more credible the information, the more weight the interpreter should give it. The objective purpose constitutes the values, goals, interests, policies, aims, and function that the text should actualize ... When these values clash, an interpreter determines ... purpose by striking the right balance between the competing values, a balance that reflects their relative weight in the legal system. The balance depends on the relative significance and status of the different values at the point of decision ...

...

Ambiguity is unavoidable and natural to natural language. Often, we can resolve the ambiguity by viewing the language in context ... For a statute, the context includes facts that provide information about the intent of the legislature – primarily the history of the statute. This history includes the pre-enactment history (the reasons and factors that led to the statute's passage, including reports of public committees), the parliamentary history (committee and plenum hearings and debates), and the post-enactment history (events taking place after the passage of the statute that point to the intent at its core).

...

Purposive interpretation presumes that the purpose of all legal texts is to realize authorial intent ... The intent of the author must project – with varying levels of force, depending on the type of text – onto the meaning of the text.⁴⁶

The purpose of the AVF Act can be constructed five four sources: (i) the authorial intention of its drafters, Professor Joshi and the Minister proposing the Bill, (ii) Mother's words on Auroville's governance, (iii) Sri Aurobindo's analysis in the *Ideal of Human Unity*, (iv) comparison with similarly worded legislations, and (v) post-legislative administrative practices and conventions.

i. Authorial Intention

The authorial intention and the purpose of the AVF Act – at core, what it was designed to achieve with the relationship of the three pillars – is elucidated upon by the (unofficial) author of the act, Professor Joshi, whose words carry interpretive weight:

This particular act has been so designed that even as it is, whatever it is, you have complete freedom to develop Auroville according to the Charter of Auroville, there's nobody who can prevent you, as long as you say, and you can show that you want nothing but the Charter of Auroville. You have complete freedom.

And how is this been designed? There are three provisions in the Act. We say there will be a governing body, there will be an international Advisory Council, and there will be a Residents Assembly and all the three are equal authorities. And what will be the relationship between these three bodies? The relationship is of mutuality and this word 'mutuality' is very important.

The most important function of the International Advisory Council is to advise and to make sure that the freedom of the members of Auroville is guaranteed. This is the function of the Advisory Council. If the Governing Board takes any arbitrary action by which the freedom of Auroville is infringed, if you can prove that this action infringes the freedom of Auroville to promote the Charter of Auroville, it can be knocked down. So you can see the mutuality. The Governing Board has to salute the Residents Assembly, has to give assurance to the Advisory Council that its actions are not arbitrary, Residents Assembly has to salute the Governing Board—nothing wrong in saluting anybody.

The Act is meant to facilitate Divine Anarchy – 'no rule from outside.' If therefore you have an Act in which the individuals constituting the totality have the freedom to grow, and if it is laid down in the Act itself that this freedom is to be ensured, the residents of Auroville should feel free and if any attempt is made to curb this freedom, then there is a provision in the Act itself of an authority whose very duty it is to advise the Governing Board in such a way that this freedom is not curbed.

This totality of residents has not been given any particular form of governance. Sometime some people reading from outside may feel it is a lacuna in the Act, that no form is given for the Resident Assembly. But from another point of view, it is a safeguard against imposition of any form. So you might say that there is an utter freedom given to the Residents' Assembly to experiment, to make research and to

⁴⁶ Barak, 2007, 89, *passim*.

devise forms by which the divine anarchy can be realised as all lands for Auroville legally vested in the Sri Aurobindo Society.

...

There were two factors in my mind when I conceived of the Foundation Act. One was that Auroville should not come to be exploited by any outside body. Therefore although it was necessary to create an authority for Auroville, my concern was to create such conditions that no authority could subject the freedom of Aurovilians to any kind of slavery or subjection. So the Governing Board and the International Advisory Council are like a check and balance on each other – if one hand is too authoritarian the other can loosen it – so Aurovilians feel there is a protecting hand and their freedom to pursue the ideals is not in any way hampered. This is the idea.⁴⁷

Despite Professor Joshi's noble intention, it is important to note that there is no legal provision in the Act by which the decision of the Governing Board 'can be knocked down' by the International Advisory Council. Rather, it can only 'advise.' Recognized canons of statutory interpretation do not allow recourse to the intention of the drafter when the legislative text is clear and unambiguous.⁴⁸

That said, the underlying thrust of the AVF Act, and its three-pillared approach, is clearly articulated in this address: first, to create an institutional vessel for novel forms of collective organization, the 'Divine anarchy', to develop; second, to provide the residents of Auroville the greatest available, yet not exclusive, freedom to develop this system; third, to create a system of checks and balances amongst the various bodies to avoid the exclusive concentration of power and the resulting possibility of authoritarianism in any body, including the Residents' Assembly; and finally, to adhere to the Charter and Mother's vision.

ii. Mother's Guidance

In this context, it is also important to refer to two statements by the Mother on this question. Mother's words, understood in the context in which they were made, are naturally to be accorded the greatest weight in the interpretation of the AVF Act. The first, dated January 22, 1971, is a response to 'some temporary visitors claiming the right to intervene in Auroville's organization'. Mother noted:

To the inhabitants of Auroville ... Only those who have resolved to stay in Auroville for good have the right to intervene in its organisation.⁴⁹

The second statement, undated, is in relation to a UNESCO project sought to be based in Auroville:

I do not know who told you that – but there is a misunderstanding somewhere because to hand over the management of Auroville to any country or any group however big

⁴⁷ Joshi, 2003.

⁴⁸ See, for example, *Vamareddy Reddy and Another v. State of Andhra Pradesh*, 2006 ('Where, however, the words were clear, there is no obscurity, there is no ambiguity and the intention of the legislature is clearly conveyed, there is no scope for the court to innovate or take upon itself the task of amending or altering the statutory provisions ... That line should not be crossed or erased.')

⁴⁹ Guigan, 2018, Vol. 2, 203.

it may be is an *absolute impossibility*. If it has been at all taken, it *is without* my knowledge – because I say to it an emphatic NO.⁵⁰

...

But we must be very careful that UNESCO does not want to take the direction of the whole affair because it would no more be a Divine creation but a human realisation.⁵¹

Though the first statement is made in the context of temporary visitors, not immediately applicable to the AVF Act, the underlying import is clear: only permanent residents, or those with an investment (of time, energy etc.), have the right to intervene in Auroville's organization. Nor, however, does that exclusive control lie with the residents ('Auroville belongs the nobody.') We may note here, in relation remarks made by several conversants, that the first statement read in its context does not support the view that advisors, experts and others do not have any say in Auroville's development – to the contrary, the early planning process indicates a welcoming and assimilative approach to expertise from elsewhere. This is, as we noted in Parts III and IV, particularly important today given lack of internal expertise in various key sectors in Auroville. This statement thus must be read in the context in which it was made, i.e., the uncontroversial proposition that temporary visitors to Auroville (short-term volunteers, tourists etc.) cannot dictate its development. The second statement clarifies this idea that management cannot be entirely 'handed over.' This is different from a careful and indeed necessary interchange with non-permanent residents or others capable of contributing to Auroville's growth.

We note here that some conversants recounted that the first statement was employed, after Mother's passing, to back the surprising view that Anger did not have a legitimate claim to participate in Auroville's development as he was not permanently resident. Given our discussion in Part I.B on Mother's reliance on and explicit support for Anger, as her chosen architect, the statement quite clearly does not lead to this conclusion. Welcoming others 'from outside' with expertise and goodwill, aligned to the vision and willing to contribute is an important part of the assimilative ethic of any developing society like Auroville. In this vein, for example, Mother noted that the development of the International Zone, for example, was to be done primarily with the participation of foreign governments, which is not an intrusion into the residents' freedom but an assimilative environment for the development of the city. The contrary view risks, as has been the case at several points in relation to planning exercises in Auroville (most recently and notably with Mr. Doshi's involvement), a dangerous insularity that closes its doors to the world born of a sense of exclusive ownership. Rather, a harmonious interpretation of Mother's words indicates that the residents being the primary trustees must actively invite others to participate in the experiment, without handing over control of management exclusively to any external body. The AVF Act incorporates this idea of the primary trusteeship, rather than exclusive ownership or management, of the Residents' Assembly. The principle of self-governance of the residents legislated in the AVF Act is, as Professor Joshi makes explicit, not primarily a negative freedom from the intervention of an

⁵⁰ Guigan, 2018, Vol. 2, 66-7 (emphasis in the original).

⁵¹ Guigan, 2018, Vol. 1, 143.

external authority but one that is rooted in responsibility. To wit, the self is free, yet only to aspire to the Self:

When one thinks of self-governance, one might think of a multitude of possibilities, when the self-governance follows the rule of the untransformed collective ego. For example - citizens are free to act according to their whims, citizens do not need the intervention of any outside authority etc. In the light of the Charter, the vision, and the historically unprecedented formation of the Act, it is clear why these ideas of self-governance are irrelevant and outdated. The Government of India was great enough to recognize and arrange for such an Act that allowed utmost freedom, but this freedom must be rooted in the utmost responsibility to do the inner work needed and to finish the project that Mother has started.⁵²

Naturally, Mother would have wanted to avoid the long and protracted battle that led to the AVF Act. Her statements must therefore be read carefully in the context of the present statutory scheme. Indeed, had those associated with Auroville, residents and members of the Sri Aurobindo Society, reached a settlement in the time given to them between the 1980 and 1988 legislations, no external authority would have entered the picture. Given the inability of those involved to do so at the time, the introduction of the Governing Board and the International Advisory Council was considered necessary to avoid the prolonged tension. Mother's comments must be read considering this material change in circumstances.

Neither of her statements indicates that none other than residents can be involved in the management of Auroville – indeed, if that were so, it would render the Act contrary to her words. However, they do clearly indicate that no ‘no group’ – ‘however big’ or indeed, eminent – can claim exclusive control. Professor Joshi's intention in drafting the Act, we can safely say, was to pay heed to this requirement, in giving neither the Governing Board nor the Residents' Assembly exclusive and untrammelled power.⁵³ However, ‘those who have resolved to stay’, the Residents' Assembly, were naturally given the primary responsibility. This explains why the gate-keeping power of admission and removal – central to the development of a spiritual collective – is given to the Residents Assembly under Section 19(2)(a), without any explicit qualification in Sections 11 or 17, pertaining to the Governing Board.⁵⁴

As we noted earlier in Part I, the *raison d'être* of Auroville, the political *līlā* it is to play, was to progressively perfect the democratic system, and move forwards towards a ‘spiritual anarchism’ guided, in its final consummation, by the descent of the Supramental. This is a collective exercise which is premised on the sovereignty of the collective: ‘... there is an utter freedom given to the Residents' Assembly to experiment, to make research and to devise forms by which the divine anarchy can be realised. ... There is not a single activity which Residents'

⁵² Auroville Tomorrow, 2022, 9. *See also*, his remark: ‘I think this Act (Auroville Foundation Act) has some very unique features, which you will not find in any act in the country. If you read between the lines, you will find that the whole Act is so formulated that it would facilitate what Mother has called ‘divine anarchy.’ Joshi, 1999, 8.

⁵³ *See*, for Professor Joshi's supporting remarks on this issue, Auroville Tomorrow, 2022, 9.

⁵⁴ *See*, Part IV. E.

Assembly cannot organise.⁵⁵ Yet, as the collective, in its journey, is subject to its own failings and excesses, the Act wisely guardrails it through the Governing Board.

iii. Comparison with Analogous Legislations

Canons of legal interpretation also require us to compare the statute under consideration with similar legislations.⁵⁶ While we have not been able to locate a similar formulation in other legislations in India or elsewhere, some short comments are in order. The phrase ‘general superintendence, direction, control and management’ used in Section 11(3) in relation to the powers of the Governing Board is common in statutes establishing institutions (for example, Section 7(2) of the Reserve Bank of India Act, 1934, Section 5(1) of the National Bank for Agriculture and Rural Development, 1981 and Section 5(1) of the National Bank Housing Act, 1987, with the last passed immediately prior to the AVF Act). In these contexts, the Governing Boards have plenary and exclusive authority, with clear vertical reporting structures, subject only to standards of administrative and constitutional reasonableness. However, as these statutes serve purposes markedly different from the AVF Act, and do not contain bodies akin to the Residents’ Assembly or the International Advisory Council, they are not in *pari materia*. Little interpretive help can be gleaned from them.

A suggestion was made during our research that the Panchayat Acts of various states are equivalent to the AVF Act, with the Residents’ Assembly and Governing Board being equivalent to the gram sabha / village panchayat and state government respectively. This is unpersuasive.

These legislations – taking as an example the Tamil Nadu Panchayats Act, 1994 (‘the 1994 Act’) – are differently structured. The 1994 Act establishes a gram sabha comprising all persons registered on the electoral role, with a mandate to approve the village plan, budget etc., a village panchayat comprising elected members, in whom the administration of the village rests, a Panchayat Union Council and District Panchayat further up tasked *inter alia* with advising the Government, and an Executive Authority of the Village Panchayat tasked with execution of decisions of the village panchayat (with the *proviso* that he may refer the decision of the panchayat to the State Government in case of an illegal exercise of powers for final decision) amongst other positions. In addition to this, the State Government has the power under Section 199 to appoint an inspector ‘for the purpose of inspecting or superintending the operations of all or any of the Panchayats constituted under this Act’, including powers under Sections 200-206 to suspend and cancel resolutions, orders, issue new orders, remove the President of the panchayat at his direction after due hearing etc. Notwithstanding anything in the 1994 Act, Sections 207-219 further provide for overarching powers to the State Government to remove the Chairman and Vice-Chairman of the Panchayat Union Council, District Panchayat, dissolve and re-constitute the village panchayat and otherwise amend, annul or replace decisions.

The AVF Act is differently structured: no powers of the kind in Sections 199-219 are found in the text of the legislation. The Residents’ Assembly is an independent statutory body which cannot be dissolved, reconstituted or otherwise restricted by the Central Government or the

⁵⁵ Joshi, 1999, 8-9.

⁵⁶ District Mining Officer and Others v. Tata Iron and Steel Co., 2001, 3.

Governing Board in the manner contemplated in Sections 205, 214-216 of the 1994 Act. No powers akin to those of the Inspector – of amending, cancelling decisions, or substituting the authority of the village panchayat with his own – are provided to any authority in the text of the AVF Act. Nor, we may note, is the Working Committee equivalent to the village panchayat in its powers. The Residents' Assembly is akin to the gram sabha in that it includes all residents, as a forum for decentralized governance, but unlike the gram sabha / village panchayat, there are no powers granted in the text to the Central Government or to the Governing Board to akin to the all-encompassing powers granted to the State Government in the 1994 Act. The text of Section 19, which lists the powers of the Residents' Assembly, is differently worded than the 1994 Act: the conjunctive 'and' in clause (1) enjoins the assembly to 'perform such functions as required by this Act' *and* 'advise the Governing Board' indicating a horizontal distribution of duties amongst equals, rather than the tiered structure in the 1994 Act.

Nor can these substantial and overriding powers be read in by way of interpretation as implicit in Sections 11(3) / 17 and 32 pertaining to the Governing Board or the Central Government. Absent express authority in the text, they must be considered as excluded from the scope of the AVF Act. This is especially so given that the drafting history records that a governmental role of the kind in the 1994 Act was not intended for Auroville. The stated legislative intention, of Professor Joshi, Mr. Shankar and members who participated in the debate, was to create a balanced system, with each authority having its independent scope of operation, in a system of checks and balances, rather than a clear hierarchy of powers legislated in the 1994 Act that handed over exclusive power to one body – this would also contradict Mother's recorded intention for Auroville. It is therefore fair to infer that Parliament considered broader coverage but rejected it. Accordingly, an implicit reading-in would transgress into the legislative domain of Parliament, contrary to recognized canons of statutory interpretation. As the Supreme Court noted in *Vamareddy*:

While interpreting a provision the Court only interprets the law and cannot legislate it ...

Courts must avoid the danger of a priori determination of the meaning of a provision based on their own pre-conceived notions of ideological structure or scheme into which the provision to be interpreted is somewhat fitted. They are not entitled to usurp legislative function under the disguise of interpretation.⁵⁷

As such, the AVF Act and the 1994 Act are dissimilar in text and intention, though motivated by the general principle of local, decentralized governance. A comparison in terms of statutory interpretation is accordingly unhelpful.

The closest comparison rather is with the Kalakshetra Foundation Act, 1993, legislated to establish a foundation for the administration of Kalakshetra, Madras, the noted cultural institution. Much like Auroville, this was done in view of

financial, managerial and other administrative problems ... pressure from vested interests to take over the institution ... litigation between the society and the trust

⁵⁷ *Vamareddy Reddy and Another v. State of Andhra Pradesh*, 2006.

[which] threatened the very existence of such a great institution ... [based on which the Government] felt the imperative necessity for taking immediate action.’⁵⁸

Sections 14 and 15 establish the Governing Board and the Academic Committee, the latter with prescribed functions concerning maintenance of academic standards. Section 14 notes:

The Governing Board *shall be the supreme authority of the Foundation* and the general superintendence, direction and management of the affairs of the Foundation shall vest in the Governing Board.⁵⁹

To the best of our knowledge, this formulation – ‘shall be the supreme authority’ – is unique to the Kalakshetra Act, 1993 and is not found in any other legislation establishing institutions since the Reserve Bank of India Act of 1934. As canons of legal interpretation require that surplusage be avoided, i.e., any interpretation must not render parts of the text otiose or redundant, one must inquire as to the necessity of the addition of the words ‘shall be the supreme authority of the Foundation’ which do not figure in previous legislations.

On one hand, it may be argued that the phrase has been used out of abundant caution. It does not imply that absent its inclusion, the Governing Board would not be the ‘supreme authority’. On the other, it may be argued *expressio unius est exclusio alterius*, a common law principle for construing legislation that a syntactical presumption may be made that an express reference to one matter excludes other matters.⁶⁰ In this reading, the inclusion of the phrase suggests, *a contrario*, that the Governing Board, in other instances such as the AVF Act, is not supreme. Else the usage of the phrase in the Kalakshetra Act, 1993 Act is rendered redundant.

The legislative history of the Kalakshetra Act, 1993 does not shed light on this question, and it is therefore not possible to establish whether the intention behind this inclusion was a response to the AVF Act by way of an express departure or simply an abundant clarification. Neither interpretive posture is conclusive. In such cases, linguistic speculations ought not to replace deeper reasoning to interpret the text to give meaning to the purpose of the statute in question.⁶¹

Thus, to sum up, the *sui generis* structure of the AVF Act does not allow for an analogous interpretation with other legislations. As each serves a different purpose, the AVF Act is best be interpreted on its own terms.

iv. Mapping the AVF Act to Sri Aurobindo’s Ideal of Human Unity

Interpretive counsel on the purpose of the AVF Act may be sought here from the *Ideal of Human Unity*. In Chapter XXI, Sri Aurobindo interestingly considers a similar institutional dynamic when speaking of an appropriate ‘governing body’ for man’s collective organization.⁶² He does so in the context of a monarchy or kingly authority, assisted by a council, and an assembly of freemen.⁶³ However, if one replaces the royal reference with a legitimately nominated body in

⁵⁸ Rajya Sabha Debates, 1993, 384.

⁵⁹ Section 14, Kalakshetra Foundation Act, 1993 (emphasis ours).

⁶⁰ Black’s Law Dictionary, 1990, 581.

⁶¹ See, Llewellyn, 1950.

⁶² Sri Aurobindo, CWSA, 1997, Vol. 25, 451-461.

⁶³ There are resonances with similar constitutional models in ancient Indian political thought, revolving around the idea of *dharma*. See, for example, Varma, 1974, 5-42. This would be an interesting area for further study.

the modern context, Sri Aurobindo's discussion maps on quite naturally to the AVF Act, and provides a route to marry the spiritual idea of the Divine anarchy with the legal form of the AVF Act. His analysis is important to quote at length:

... in engrossing the legislative power the monarchy has exceeded the right law of its being, it [the king] has gone beyond its dharma, it has undertaken functions which it cannot healthily and effectively fulfil. Administration is simply the regulation of the outward life of the people, the ordered maintenance of the external activities of its developed or developing being, and the king may well be their regulator; he may well fulfil the function which the Indian polity assigned to him, the upholder of the 'dharma'. But legislation, social development, culture, religion, even the determination of the economic life of the people are outside his proper sphere; they constitute the expression of the life, the thought, the soul of the society which, if he is a strong personality in touch with the spirit of the age, he may help to influence but which he cannot determine. They constitute the national dharma, — we must use the Indian word which alone is capable of expressing the whole idea; for our dharma means the law of our nature and it means also its formulated expression. Only the society itself can determine the development of its own dharma or can formulate its expression; and if this is to be done not in the old way by a naturally organic and intuitive development, but by a self-conscious regulation through the organised national reason and will, then a governing body must be created which will more or less adequately represent, if it cannot quite embody, the reason and will of the whole society.

Legislation may seem at first sight to be something external, simply a form for the administration, not part of the intimate grain of the social life like its economic forms, its religion, its education and culture ... All this, it might seem, might well fall within the province of the king and be discharged by him with as much efficiency as by a democratic government. But it is not so in reality, as history bears witness; the king is an inefficient legislator and unmixed aristocracies are not much better. For the laws and institutions of a society are the framework it builds for its life and its dharma.

He cannot determine the economic life, that too is much too large for him; he can only watch over it and help it in this or that direction where help is needed. He cannot determine the religious life, though that attempt has been made; it is too deep for him; for religion is the spiritual and ethical life of the individual, the relations of his soul with God and the intimate dealings of his will and character with other individuals, and no monarch or governing class, not even a theocracy or priesthood, can really substitute itself for the soul of the individual or for the soul of a nation.⁶⁴

The plenary powers of the Governing Board, read with the advisory capacity of the International Advisory Council, and the broad mandate of the Residents' Assembly can be readily mapped onto this analysis. The Governing Board is, if we follow Sri Aurobindo's scheme, tasked with regulation and influence, but not determination, in respect of day-to-day affairs across economy, culture and legislation. These matters are, as Sri Aurobindo notes, a reflection of the community's self-expression and must be primarily guided through a body 'which will more or less adequately represent ... the reason and will of the whole society,' in this case the Residents' Assembly. The Governing Board, in these respects, holds a critical role

⁶⁴ Sri Aurobindo, CWSA, 1997, Vol. 25, 455-60.

‘as the upholder of the *dharma*’, Mother’s Charter. However, in respect of the ‘outward life of the people’, the Governing Board can go further and has the task of ‘ordered maintenance’, which is similar to the formulation of ‘secure proper management’ in Section 17(d).

To reflect on the passage above in the Auroville context, we suggest a distinction between the spiritual and cultural Auroville and the funds, assets and properties of the Auroville Foundation. If we are right in this analysis, the distribution of responsibilities articulated in the paragraph above flows. The former includes the development of manifold activities and programmes across the seven sectors identified in Part II and experiments of collective organization in relation to those sectors – these are the *dharma* of the evolving collective, the Residents’ Assembly, and reflect its self-expression. The latter includes the funds, properties and assets of Auroville vested in the Foundation, measurable, quantitative growth targets emanating from the Masterplan and subsequent development plans developed by the community itself (as also law and order and other matters of a similar nature), which require transparent and ordered auditing, monitoring and management – these are the ‘outward life’, under the responsibility of the Governing Board. Given three factors – (i) the history of alleged financial mismanagement leading to the 1980 Act, (ii) the substantial assets vested in the Foundation today, including external donations, both Indian and foreign, and (iii) the administrative imperative for a named body to be responsible, as opposed to an assembly, which is by its corporate character not individually accountable – the ultimate responsibility of the Governing Board in this domain is clear, and conversely, so are its powers.

Governor Ravi, Chairman of the Governing Board, also suggests, though with a varying emphasis, this distinction between the inner and physical Auroville in a speech of 25th February, 2022 – indicating that the task of inner and cultural evolution is within the collective domain, whilst the Government of India that appoints the Governing Board can assist in the development of tangibles, infrastructure etc.:

Unfortunately we have seen a large number of groups, factions [in Auroville] ... now these are all at a very subordinate level. It is not the level which Sri Aurobindo had imagined or envisioned. We are still trapped at a very, very subordinate level. It has to evolve. But this evolution cannot be done by the government. What the Government of India can do, has to do, and will do: the physical aspect of it. Because Mother had given a design of what the township should be like. To see that that design - what we call town planning - is to manifest, is to be created. That is, a physical infrastructure of a township, where the potential *Mahamānavs* will be sitting, dwelling on that issue of going up to that higher level of consciousness and setting an example for the rest of the world.⁶⁵

This distinction also has a practical reason: as the members of the Governing Board are usually not permanently resident in Auroville and hold full-time positions of eminence in their respective fields, their knowledge of the day-to-day affairs, as also their time, will ordinarily be limited. As one resident noted:

... it puts members of the Governing Board ... in an invidious position. Doubtless they have our best interests at heart but they have no way of knowing, without

⁶⁵ Auroville Tomorrow, 2022, 4.

extensive research, the veracity of the ‘facts’ that are being put before them or the wisdom of the action they are being asked to take by individual appellants. And even if they decide to act, they are likely to be criticized by others for ‘interfering’ in our internal process. In other words, they can’t win.⁶⁶

This observation was also made by a member during the passage of the AVF Act, in relation to the relative placement of the Governing Board and Residents’ Assembly:

The Governing Board itself may meet once a year. That suggests that it is not going to be an executive body. Then the Residents’ Assembly is going to be the most important body ... high powers are not going to be given [to the Governing Board] because it is the residents that will matter the maximum in this administration.⁶⁷

This problem generated by non-residence in Auroville was also recognized by Mr. Diène in the context of the International Advisory Council. His concern, we may suppose, applies to the Governing Board as well:

... the mandate of the IAC obliges the members to advise the Aurovilians and the Governing Board in the spirit of the Auroville Charter. But how do they advise? First, as a priority, they have to listen very carefully, very profoundly, to the Aurovilians because they don’t know Auroville. They have to learn what Auroville is and what is going on, because Auroville is something in the making. So it is important to understand the dynamic as well as the problems the Aurovilians are facing.⁶⁸

Thus, the distinction drawn in Sri Aurobindo’s discussion, reflected with a varying emphasis in statements by members of the Governing Board and International Advisory Council, provides a helpful foil to interpret the distribution of powers under the AVF Act. That said, this distinction is naturally not hermetic as the development of the physical infrastructure of the city Governor Ravi addresses above is, as we discussed in Part I.C (‘spiritual urbanism’), equally an aspect of the collective’s spiritual growth and expression. City-development and consciousness-raising – the material and the spiritual – are centrally linked. The idea is not, in Anger’s words, to build the city and ‘*then* we ask people to come and inhabit the city.’⁶⁹ Rather, ‘the approach is reversed: people live the experience, and from that experience, their living conditions and environment will be created and established’, ‘we would like Auroville to materialize according to its own dynamism so that real communion establishes itself between those who will live in Auroville and those who will create it. This is ... one of the most difficult problems to solve.’⁷⁰

This may and in the recent past has invited disagreement on core questions of city building (development of the Crown etc.) and if the spirit of mutuality does not persist, will naturally tend to conflict.⁷¹ Indeed, Sri Aurobindo anticipates this problem: he notes that an equilibrium between a centralized body and the assembly, i.e., the Governing Board and Residents’ Assembly, will be preceded by a balancing process, given the twin demands of communal self-

⁶⁶ Auroville Today, January 2020.

⁶⁷ Raja Sabha Debates, 1st September, 1988, 486.

⁶⁸ Auroville Today, December 2020, 10.

⁶⁹ Danino, 2021, 1 (translation is Danino’s).

⁷⁰ Anger, ‘=1’, 1968.

⁷¹ Minutes of 61st Meeting, Governing Board, Auroville Foundation, 2022, 22.

expression and centralized ordering, that likely invites conflict. It is interesting to note that Sri Aurobindo's discussion is located in Chapter XXI, entitled 'The Drive towards Legislative and Social Centralisation and Uniformity': he places the relationship between the centralized body of nominated persons (adapted for our discussion here) and the assembly of freemen as a *necessary* historical dialectic between two movements: the centralizing and decentralizing impulses, the former locating the collective will in a single body or person (the Governing Board), and the latter in the developing *demos* (the Residents' Assembly).⁷² He points to a historical movement from one extreme to the other with a resulting friction and creative instability, which maps on to the historical development of governance in Auroville quite distinctly, settling the equilibrium finally in the careful division he posits. He notes:

Originally, all these powers belonged to the organic society and were put into force mainly by various natural devices of a loose and entirely customary character, such as the Indian panchayat or village jury, the jurisdiction of guilds or other natural associations, the judicial power of the assembly or convocations of the citizens as in the various Roman comitia or large and unwieldy juries chosen by lot or otherwise as in Rome and Athens, and only to a minor extent by the judicial action of the king or elders in their administrative capacity ... [reflecting the earlier movements of governance prior to the AVF Act], Thus eventually the State — or the monarchy, that great instrument of the transition from the organic to the rational society — becomes the head of the law as well as the embodiment of public order and efficiency ... [reflecting governance practices post the AVF Act, with an increasing, but careful, centralization in the Governing Board as also bodies constituted by it such as the TDC, FAMC etc.]

But before we can arrive at this stage, the great question must be settled, who is to be the State? Is the embodiment of the intellect, will and conscience of the society to be a king and his counsellors or a theocratic, autocratic or plutocratic governing class or a body which shall at least seem to stand sufficiently for the whole society, or is it to be a compromise between some or all of these possibilities? The whole course of constitutional history has turned upon this question ... in reality ... [society] had to debouch in the end in a democratic form of government.⁷³

Before we reach that end, the centralizing impulse, which looks to rationalize and organize loosely cast customary practices in the society (an important and valid concern in Auroville, as we discussed in Part IV), is both necessary and inevitable:

It was inevitable because this transitional instrument represented the first idea of the human reason and will seizing on the group-life to fashion, mould and arrange it according to its own pleasure and power and intelligent choice, to govern Nature in the human mass as it has already learned partly to govern it in the human individual. And since the mass is unenlightened and incapable of such an intelligent effort, who can do this for it, if not the capable individual or a body of intelligent and capable individuals?⁷⁴

⁷² Sri Aurobindo, CWSA, 1997, Vol. 25, 451-461.

⁷³ Sri Aurobindo, CWSA, 1997, Vol. 25, 451-2.

⁷⁴ Sri Aurobindo, CWSA, 1997, Vol. 25, 459.

Yet, the primary instrument of that process – in the *ideal* movement – is the self-organizing *demos* itself, whose powers are inherently plenary in a democratic arrangement. This clarifies the incompleteness in the text of Section 19 we identified above, by granting the residents broad, yet unspecified, general powers in clause (1) in addition to the indicative list in clause (2). However, insofar as the *demos*, the Residents' Assembly, does not achieve that result (city-building in line with Mother's ideals), the pressure of the centralized body, the Governing Board, is a required corrective in the teleological movement Sri Aurobindo identifies. This gives meaning to Section 17(a)-(e), which enjoins the Governing Board ensure integration, cohesion and coordination, all necessary centralizing measures for efficient working: '... to coordinate activities and services of Auroville in consultation with the Residents Assembly for the purposes of cohesion and integration of Auroville', 'prepare a master-plan ... and to ensure development of Auroville as so planned.'

In the ideal movement, the centralized body's powers are, in Sri Aurobindo's understanding, limited to ordered maintenance, regulation, oversight, as the upholder of the *dharma*, Auroville's ideals (again reflected in Section 17(a)-(b), (d)), for any deeper effort addressing social, economic or spiritual movements in the polity ('the expression of the life, the thought, the soul of the society') is likely inhibited by its relative distance. This seems to be Mr Diène's concern as well. These matters are 'outside his proper sphere', which 'he may help to influence but which cannot determine.' With this understanding, Sri Aurobindo locates a great responsibility on the *demos*, the residents of Auroville, to take on itself that task (rather than oppose the valid corrective sought to be introduced):

For what king or aristocracy could not do, the democratic State may perhaps with a better chance of success and a greater security attempt and bring nearer to fruition, — the conscious and organised unity, the regularised efficiency on uniform and intelligent principles, the rational order and self-governed perfectioning of a developed society. That is the idea and, however imperfectly, the attempt of modern life; and this attempt has been the whole rationale of modern progress.

... for how else [is] ... profound thing we call life to be taken hold of, dominated, made calculable and manageable by a logical intelligence and unified will? Socialism is the complete expression of this idea. Uniformity of the social and economic principles and processes that govern the collectivity secured by means of a fundamental equality of all and the management of the whole social and economic life in all its parts by the State; uniformity of culture by the process of a State education organised upon scientific lines; to regularise and maintain the whole a unified, uniform and perfectly organised government and administration that will represent and act for the whole social being, this is the modern Utopia which in one form or another it is hoped to turn, in spite of all extant obstacles and opposite tendencies, into a living reality.⁷⁵

⁷⁵ Sri Aurobindo, CWSA, 1997, Vol. 25, 461-2. Professor Joshi similarly locates the freedom of the residents beyond individual liberty: 'The truth of individualism, as I said earlier in another context, is not merely the guarantee of individual freedom. This is something that is highest in many constitutions — that the moment you give the freedom of expression, freedom of association, you have given the best and the highest. That is not the concept of Auroville. Individualism is fundamentally service of the Divine in each individual. This is the real truth of individualism ...' Joshi, 1999, 9.

In sum, Sri Aurobindo's analysis provides a textured understanding of the constitutional framework in the AVF Act: (i) conceptually, it speaks to the ideal functions – relative distributions of duties – of the Governing Board and the Residents' Assembly, each necessary for the development of Auroville, (ii) historically, it speaks to the inevitable shifting balance between them, through different stages of Auroville's development, (iii) with the insight that appropriate correctives will be applied in either direction as 'compensating reactions', depending on how loose or firmly-organized the *demos* is.⁷⁶ This balance of forces has in practice determined the constitutional workings of Auroville, leaning in one direction or the other, with an equilibrium yet to be found. The ambiguity on this point – of the relationship of the Governing Board and the Residents' Assembly – was deliberately kept as such. During the passage of the AVF Act, 1988, Mr. Tombi Singh raised this concern explicitly, but the matter was left untouched:

... there is no mention anywhere how matters [of the Governing Board] are to be conducted with relation to the Residents' Assembly. As it is, I see certain lacunae in the drafting of the Bill. If it is so, perhaps, the Government may see that these lacunae may be eliminated because this experiment in (sic) international cultural township is going to be a very critical test ...

Already we have seen in the past that there has been a dispute or difference of opinion on matters of finance. power and other things. Unless these are tackled properly, this is going to create some problems. Government has good intentions that this legislation will remove the difficulties. Unless there is a proper liaison between the Government board and the Residents' Assembly, this problem will not be solved; rather it may invite criticism ...⁷⁷

The 'critical test', it appears, is being faced today. The Governing Board's timely remark reflects this sentiment:

The Board also noted that if the collaboration between the Working Committee and the GB or RA remains largely antagonistic, it will be detrimental to the development of Auroville.⁷⁸

It is in this context that our proposals in Part III must be read (for a Steering Group, constituted jointly by all three statutory bodies; nominations of the Governing Board and International Advisory Council to the Council of the Wise; zonal and sub-zonal confederated organization etc.) to develop firm institutional forms that can generate this equilibrium and mutuality.

v. *Mr. Sorabjee's Opinion*

It is also useful here to refer here to a legal opinion requested in 2008 by the Working Committee of the Residents' Assembly from Mr. Soli Sorabjee, ex-Attorney General of India, which ties to our understanding of Sri Aurobindo's words. He was asked to opine on two issues: 'the position of the Foundation in relation to the Government of India' and 'the extent of

⁷⁶ For a discussion on this balancing system, *see*, Sri Aurobindo, CWSA, 1997, Vol. 25, 523-5.

⁷⁷ Rajya Sabha Debates, 1st September, 1988, 486-7.

⁷⁸ Minutes of 61st Meeting of the Governing Board, 2022, 20.

autonomy enjoyed by the Residents' Assembly within its own sphere of functioning'. His conclusions were:

As explained above, the power to disburse funds vests solely with the Foundation, to be exercised by the Governing Board in accordance with the Act and the Rules made thereunder. There is no provision under the Act nor is there any legal principle from which it can be inferred that the Secretary of the Auroville Foundation must be a compulsory co-signatory to all disbursement of funds. The Secretary is an appointee of the Central Government and, unlike other office bearers who are required to be selected from amongst those who have contributed valuable services to Auroville, is a bureaucrat. By virtue of sec. 15 the Secretary can exercise only '... such powers and perform such duties under the Chairman of the Governing Board as may be prescribed or as may be [specifically] delegated to him by the Chairman'. It is significant that for the last over 15 years this Fund has been managed by Aurovilians alone and this practice has not been doubted by any authority so far.

The above section [Section 19] makes it amply clear that the role of the Residents' Assembly is not limited to acting in an advisory capacity. Section 19(1) is in two parts. While the first part provides that the Residents' Assembly shall perform such functions as are required by this Act, the second part envisages an advisory role in respect of all activities relating to the residents of Auroville. On a correct reading of the above section it is clear that the functions mentioned in Subsection (2) are relatable to the first part of subsection(1) and are therefore not limited to a mere advisory role. In other words the matters enumerated in sub-section (2) are within the domain of the Residents' Assembly in which sphere the Assembly enjoys autonomy. Thus, on a harmonious reading of the powers of the Board and the Assembly, it is clear that the *initiation* of the activities mentioned in sub-section (2) must come from the Residents' Assembly. Of course, the admission or termination of names in the register of residents is subject to any regulations made in that behalf; the programmes drawn up by the Assembly are subject to approval of the Governing Board by virtue of section 17(c) and the disbursement of funds for the various activities/programmes is also within the domain of the Governing Board. However, in my opinion while taking all decisions 'in respect of all activities relating the residents of Auroville', the Governing Board is required to give due weight to the advice of the Residents' Assembly since the Act envisages a specific advisory role of the Assembly in that behalf. The Governing Board cannot render such a role that is specifically envisaged by the Act redundant by unreasonably rejecting the advice of the Residents' Assembly. At the same time the decisions of the Governing Board must subserve the objects of the Act which are, inter alia, to further the development of Auroville and its residents 'in accordance with the original charter of Auroville' and to advance the ideals for which Auroville had originally been established. An important objective sought to be achieved by the Act, through the International Advisory Council, is to ensure that 'the residents of Auroville are allowed freedom to grow and develop activities and institutions for the fulfillment of the aspirations and programmes envisaged in the said Charter of Auroville'. Like every power conferred by statute, the Governing Board must also exercise its powers purposefully to further these objects of the Act.

...

The Act envisages that the three constituents of the Foundation will work in harmony and co-ordination, with minimal governmental interference ... Needless to mention, the decisions and functioning of the Governing Board and its decisions must keep in mind that the residents are the ultimate beneficiaries of the Foundation and the purpose of enacting the statute was not to 'take over' the properties of Sri Aurobindo Society but to consolidate the undertakings and facilitate the fulfillment of the vision conceived in the original Charter.⁷⁹

Our interpretive scheme of the AVF Act thus far coheres with Mr. Sorabjee's opinion. Two points may be made here:

First, Mr. Sorabjee concluded that the Auroville Foundation is an autonomous statutory body, and not a department of the Government of India. The ultimate responsibility for the disbursement of funds thus lay with the Foundation, to be exercised by the Governing Board 'in accordance with the Act'. The plenary power of the Governing Board is self-limiting and fettered by the AVF Act, which requires that it pay due regard to the advice of the Residents' Assembly, not as a matter of discretion but obligation. His reasoning traces this obligation to the Governing Board's duty to further the objective (or purpose) sought to be achieved by the AVF Act, *inter alia* securing the freedom of the Residents' Assembly 'to grow and development activities and institutions' under Section 21(4)(b). This flows from the fact that 'the residents are the ultimate beneficiaries of the Foundation'. As such, the autonomy of the Residents' Assembly is baked into the powers of the Governing Board under Sections 11 and 16, which are thus robust but self-limiting. It is along these lines that Professor Joshi remarked that the 'the scope is widest ... there is not a single activity which Residents' Assembly cannot organise.'⁸⁰

Second, the disjunctive 'and' in Section 18 means that the Residents' Assembly is not a 'merely advisory' body; rather, in respect of matters enumerated in sub-section (2), 'the Assembly enjoys autonomy', thus outlining an independent sphere of legislative and executive action. Indeed, it bears emphasis that as the power of *initiation* lies with the Residents' Assembly, in Mr. Sorabjee's view, the exercise of the Governing Board's powers are dependent on the effective operation of the former.

Mr. Sorabjee's legal opinion thus supports a *via media* approach, that first, substitutes exclusive authority with the mutuality emphasized by Prof. Joshi as the spirit behind of the AVF Act, and second, recognizes the distinction between the 'inner life' of the residents, where they enjoy autonomy, and the 'outer life', pertaining especially to funds and assets, where the Governing Board is tasked with oversight and approval. In this, his opinion dovetails with Sri Aurobindo's scheme.

It also bears mention that Mr. Sorabjee's emphasis on the deliberative relationship between the Governing Body and the Residents' Assembly, drawing from Section 21(4)(b), is linked to democratic conception is Sri Aurobindo's thought, which undergirds the ideal of the Auroville

⁷⁹ Sorabjee, 2008, 7-10 (emphasis in original). We may note here that from the time of the 1980 Act, the Central Government's support for Auroville has been positive and facilitative, with minimal interference, sizeable grants and concessions, including income tax exemptions, provision of special visas etc. The general fear of governmental excess in our conversations has limited basis in the historical records.

⁸⁰ Joshi, 1999, 8-9.

and that of the Residents' Assembly. As we discussed in Parts I and IV, the perfection of the democratic conception is a *marker* of an ideal Auroville society, the *telos* – such that the centralized authority is 'conterminous with the society itself or directly representing it', in the ideal 'the State [the empowered centralized authority] and society become, as far as that may be, *synonymous*', through the depth of spiritually enlightened democratic engagement.⁸¹ This movement is critical to the interpretive scheme of the AVF Act – this centralized self-regulation through the Residents' Assembly is a 'sign that the society is getting ready to be an entirely self-conscious and therefore a freely and consciously self-regulating organism'. However, these may be, as indeed is the case in our empirical assessment in Parts II and III, at the a 'first crude and bungling attempt', that may require centralizing correctives from the Governing Board, but in the end allowing for the 'development of the society as an organism consciously and entirely legislating for its own needs'.⁸² Naturally, then, 'engrossing' all powers in a single authority outside of the residents as a matter of law under the AVF Act is, as Sri Aurobindo notes, an excessive and unfruitful endeavour.⁸³ This would be contrary to the text and spirit of the legislation.

Both inherent and instrumental reasons thus support Mr. Sorabjee's emphasis on the autonomy of the Residents' Assembly in relation to the Governing Board in addition to its advisory role. In this, it gives meaning to the legislative intention reflected in Mr. Menon, Mr. Chavan, Mr. Pant and Prof. Joshi's remarks discussed above.

vi. Concluding Remarks: Mutual Interdependence of Governing Board and Residents' Assembly

In sum, following this assessment, the independent statutory basis of the Residents' Assembly and the Governing Board, each operating in its own sphere, is clear in the text or legislative intention, read in the background of Sri Aurobindo's discussion. Two concluding remarks made be made in this context, in relation to the view that the functioning or status of the Residents' Assembly is subject or subordinate to that of the Governing Board.

First, the text of Section 10 of the AVF Act establishes three 'authorities' comprising the 'Auroville Foundation', a body corporate, which as Mr. Sorabjee concludes is an autonomous statutory entity. The Residents' Assembly is thus an independent body created by statute. A distinction is useful here between a statutory body and a body that is created under the provisions of a statute. As the Supreme Court noted in *Vaish Degree College*:

It is, therefore, clear that there is a well marked distinction between a body which is created by the statute and a body which after having come into existence is governed in accordance with the provisions of the statute. In other words the position seems to be that the institution concerned must owe its very existence to a statute which would be the fountain-head of its powers. The question in such cases to be asked is, if there is no statute would the institution have any legal existence. If the answer is in the negative, then undoubtedly it is a statutory body, but if the institution has a separate

⁸¹ Sri Aurobindo, CWSA, 1997, Vol. 25, 446 (emphasis ours).

⁸² Sri Aurobindo, CWSA, 1997, Vol. 25, 445-6.

⁸³ Sri Aurobindo, CWSA, 1997, Vol. 25, 456.

existence of its own without any reference to the statute concerned but is merely governed by the statutory provisions it cannot be said to be a statutory body.⁸⁴

By this measure, the Residents' Assembly and Governing Board are equal and independent statutory bodies created under Sections 18 and 11 the AVF Act. As the Supreme Court noted in *Sukhdev Singh*, all powers exercised by either body must trace themselves to within the four corners of the AVF Act:

The authority of a statutory body or public administrative body or agency ordinarily includes the power to make or adopt rules and regulations with respect to matters within the province of such body provided such rules and regulations are not inconsistent with the relevant law ... These statutory bodies cannot use the power to make rules and regulations to enlarge the powers beyond the scope intended by the legislature.

The powers of statutory bodies are derived, controlled and restricted by the statutes which create them and the rules and regulations framed thereunder. Any action of such bodies in excess of their power or in violation of the restrictions placed on their powers is *ultra vires*. The reason is that it goes to the root of the power of such corporations.⁸⁵

The power to alter the Residents' Assembly, however, does not find mention, indeed intentionally so, in Sections 11 and 17, unlike for example, in the Tamil Nadu Panchayats Act, 1994 where such a power is explicitly delineated. Any change to this legal architecture is possible only through statutory amendment by Parliament. Neither body is thus subject for its existence on the other, yet each is co-dependent for an effective manifestation of the city: the Governing Board is limited if the Residents' Assembly or its constituent Working Groups do not initiate and execute, and the Assembly is limited if the Governing Board denies approval in spheres of common action as, for example, the drafting, approval and execution of the Masterplan.

Second, we note that the register of residents is required to be maintained regularly under Section 18(2) by the Secretary to the Governing Board. Whether this was done is a factual matter, for which we were not able to access the records and thus are unable to offer comment. However, this is a practical matter that must be dealt with urgently in respect of identified discrepancies alongside the regular work of the Assembly in whom resides the primary trusteeship for Auroville. As a practical matter, we may suggest that attendance may be recorded in respect of residents present at the meeting and whose status is not controverted at the least as per the last available register, and an *ad interim* register in respect of others, which can be validated immediately after. This allows for all statutory bodies to operate, whilst ensuring the integrity of the legal process.

In sum, purpose of the AVF Act, so constructed, provides an interpretation that is sensitive to the dynamics of Sri Aurobindo and Mother's guidance:

⁸⁴ Executive Committee of Vaish Degree College and Ors. v. Lakshmi Narain and Ors., 1976.

⁸⁵ Sukhdev Singh and Ors. v. Bhagat Ram and Ors., 1975, paras. 15, 18.

- i. The forum of the Residents' Assembly, which reflects the space for the progressive development of the democratic 'idea-force', aspiring to the perfection of the 'spiritual anarchist', with its own substantial challenges and inevitable failings, must therefore play a leading though not exclusive role in the scheme of the AVF Act. This role is best seen as a responsibility or duty, a stewardship entrusted by Mother, rather than a negative right to freedom from external interference. As Professor Joshi noted: '... when we say that Auroville is for freedom — this is very often voiced among many people, that we are here free — it is an incomplete sentence. We are here for freedom certainly, but freedom to discover the Divine.'⁸⁶
- ii. The Governing Board, in this scheme, is tasked as the 'upholder of the *dharma*', with ordered maintenance, regulation and influence to organize, rationalize and guide but not determine matters, in relation to social, economic and spiritual developments ('inner life'), with greater authority insofar as funds, asset and property management, law and order etc. are concerned ('outer life').
- iii. In practice, until and to the extent the Residents' Assembly becomes 'intelligently self-governing' with a 'firm' organization, the Governing Board's corrective push is an 'inevitable, fruitful and ... necessary step' to secure effective self-governance in and by the *demos*.

vii. Role of the International Advisory Council

It is in this context that the role of the International Advisory Council can also be understood, as an independent check and wise mediator with timely counsel to both bodies. As we were not able to locate records in the Auroville Archives speaking to previous communications between the Council and the Governing Board / Residents' Assembly, our discussion here is limited to the following three points:

First, we note that recent relations between the Governing Board and some members of the Advisory Council have been fractious. This tension is, in a sense, a built-in feature of the system of checks and balances where the Council is charged, in Professor Joshi's words, to 'knock down' the Governing Board's decisions if they are 'too authoritarian' and do not comport with the Charter. That said, it is trite to note that the spirit of mutuality between the bodies, with respectful dialogue even and particularly in case of disagreement, is necessary for the optimal functioning of the system.⁸⁷

Second, we note that Professor Joshi's remarks would support the practice of the International Advisory Council meeting independently of the Governing Board, to perform its function of acting as a check on the Governing Board. As Mr. Diène, a past member of the Council, noted:

⁸⁶ Joshi, 1999, 9.

⁸⁷ See, for example, the Governing Board's recent appreciation for Ms. Merriam's 'Heart Weaving' initiative as Chairperson of the International Advisory Council. Governing Board, 61st Minutes of Meeting, 2022, 21-22. See also, Minutes of the 26th Meeting of the International Advisory Council, 2014, 1.

... all the separate meetings the IAC had had in the past with the Governing Board and Aurovilians to reflect and give advice ceased because it was decided that Governing Board and the IAC would only be meeting the Aurovilians together. So there was no longer this very important factor of separation of judgment, of reflection, which gave credibility to the IAC when they reported and advised the Aurovilians and the Governing Board.⁸⁸

Third, the records indicate that the Council's engagement over the years has been variable owing to a host of practical reasons (with, at least in the view of two members of the Council, a reluctant uptake of their advice when given).⁸⁹ It may be useful here to institute the following practice of (i) a regular, termly report from the Unity Committee, as the body charged with internal evaluation and monitoring in our proposed scheme in Part IV, to the International Advisory Council, to which (ii) the Council can, in turn, provide its comments to the Governing Board, Unity Committee, Residents' Assembly and / or relevant Working Group, as the case may be, to allow for its guidance to be plugged regularly into the system. It is also with this in mind our proposal in Part IV for a nominee from the Council on the Steering Group can be considered.

viii. Post Enactment Administrative Conventions

In addition to the text and the purpose of the ACF Act, it is also useful to map the convention of practice since 1988. This is a useful guide in the interpretation of administrative statutes. We find that it supports our reading above, though with exceptions, if one looks historically to the committees appointed by the Governing Board under Section 16 read with Rules 5(1)-(2), and those appointed by the Residents' Assembly under Section 19(3) read with Rule 5(3).

For matters pertaining to the 'inner life' – represented in the various Working Groups – the general tenor has been for the Residents' Assembly to regulate their selection through its own processes, discussed in Part III. For matters pertaining to the 'outer life', the Rules notified under Section 31 of the AVF Act which detail the responsibilities and processes within the remit of the Governing Board concern themselves almost exclusively with funds and assets.⁹⁰ Rule 5 constitutes two committees of the Governing Board, which report to it, under Section 16(1), the Finance Committee (later reconstituted under Standing Order 1 / 2009) and the Funds and Asset Management Committee. Rule 6 notes that the Secretary to the Foundation, whose powers are discharged under the authority of the Chairman of the Governing Board, is required to 'maintain the accounts of the Foundation.' Rule 10(2)(ii) further notes the Governing Board's authority in respect of any funds withdrawn from the Foundation, which includes, in today's context, contributions from Auroville units:

All funds shall be paid into the Foundation's accounts with the Bank and shall not be withdrawn except through a cheque signed by such authorised person(s) as may be duly empowered in this behalf by the Governing Board up to such limits and for purposes to be specified in the regulations.⁹¹

⁸⁸ Auroville Today, December 2020, 10.

⁸⁹ Conversation with Luyckx and Diène, YouTube, 2022.

⁹⁰ Auroville Foundation Rules, 1997.

⁹¹ Rule 10(2)(ii), Auroville Foundation Rules, 1997.

Based on the limited records we have seen, the historical administrative practice of office orders issued by the Secretary to the Foundation, drawing their authority from powers delegated by the Chairman of the Governing Board, follows a similar pattern: they pertain largely to funds (disbursement of moneys, signing of cheques), assets (borrowing, sales, land purchase and exchange etc.), constitution of new legal bodies (trusts etc.), auditing and financial management (preparation, validation of accounts etc.) Historically, the Secretary has also issued Office Orders since May 14, 1992 for ‘for the creation of new Units and appointing executives for the said undertakings to carry on for and on behalf of the Governing Board of the Auroville Foundation.’⁹² Pursuant to the ‘Agreement between Trusts and Units’, approved by the Governing Board in its 45th Meeting in 2014, this practice was discontinued and delegated to the FAMC under Standing Order 10 of 2015.⁹³ The trend, at least *de facto*, has thus been towards bodies constituted by the Governing Board, but nominated and populated, for the majority of the membership, by the Residents’ Assembly and its Working Committee. We were not able to locate records speaking to whether the Governing Board has historically rejected the nominations put forward by the Residents’ Assembly or its Working Committee. This will materially affect our analysis, as previous administrative practice informs statutory interpretation. Anecdotally, from conversations with members of various Working Groups, we were informed that this has not occurred. It is possible to explore, as a matter of future convention, whether the Governing Board / Steering Committee, if instituted, can return Residents’ Assembly nominations with reasons / recommendations, and require fresh names to be presented, but itself not select, as a way of activating the checks and balances system, where deemed appropriate.

In any case, this novel, and useful, practice of delineating constitution by the Governing Board and nomination / selection by the Residents’ Assembly indicates a structure of dual responsibility: immediate responsibility to the Residents’ Assembly, with oversight by the Governing Board as a check on the internal processes to ensure accountability. This is an example of guidance, rationalization and organization by the Governing Board, with space for the Residents’ Assembly to regulate its inner life, the balance suggested by Sri Aurobindo.

However, we may note here that repeated and timely requests by the Governing Board concerning land acquisition, reform of deliberative processes in the Residents’ Assembly, monitoring and evaluation of Working Groups, implementation of the Masterplan through a Detailed Development Plan and other urban infrastructure, including at the important 2015 Retreat attended by members of all three pillars, have remained unheeded in the past. This ‘antipathy’ towards the Governing Board, as Dr. Singh labelled it his capacity as Chairman, is not in the spirit of mutuality.⁹⁴ This spirit demands a responsive interface, absent which a corrective push from the Governing Board is, in Sri Aurobindo’s view, inevitable. From conversations, anecdotally, it seems that the remnants of the conflict with the Sri Aurobindo

⁹² Code of Conduct for all Trusts and Units of the Auroville Foundation, 2017, 1, fourth preambulatory paragraph.

⁹³ Auroville Foundation, Standing Order 10/2015, 2015.

⁹⁴ See, for example, 43rd Minutes of Meeting, Governing Board, Auroville Foundation; Auroville Today, August 2017, 61.

Society, and a general distrust of authority (particularly governmental authority), have a continuing and outsized imprint in the community.

In this regard, the need for sensitive, efficient bureaucratic ordering of information and processes between the three pillars, ensuring transparency and accountability, is as we noted in Part III necessary to the growth of the collective.⁹⁵ This is an area for urgent research and action in Auroville's governance.

In sum, Auroville is a large collective of tangible and intangible activities and assets. Whilst the various intangibles – spiritual, cultural, educational and otherwise – that constitute Auroville are the primary responsibility of the collective, the tangibles – relating to funds, assets and properties, law and order and measurable growth targets emanating from the Masterplan and subsequent development plans – can be subject to the Governing Board's 'ordered maintenance'. Naturally, this distinction is not hermetic, as the two intersect. Yet, the careful phrasing of Sections 11, 17, 18, 19, 20 and 21 of the AVF Act, read harmoniously, points in this direction, as does as the history of its drafting and most importantly, the purpose of Auroville understood through Mother and Sri Aurobindo's words.

*

⁹⁵ As Majumdar notes, the initial resistance to the system of office orders underwent a transition: 'The new secretary then decided to start introducing a few needed regulations, like an office order, and before long, we have a thundering revolt on our hands ... Today, that particular regulation is routine. No one even blinks at such things any more, but it was a transition we had to go through.' Majumdar, 2017, 243.

E. PAST ADMINISTRATIVE PRACTICE AND SUGGESTIONS

Archival records also indicate some administrative uncertainty as to the precise relationship between the bodies' constitution and accountability structures. The *via media* has, we note from the archives, been a subject of regular debate,⁹⁶ or as one member noted, 'a continuous tug-of-war.'⁹⁷ We consider the past administrative practice, insofar as it has a bearing on the interpretation of the AVF Act. Our proposals for governance reform are outlined in Part IV.

i. *Dual Constitution and Nomination*

Historically, several working groups, notably the TDC L'Avenir, FAMC, LCC and Unity Fund, have been constituted by the Governing Board through Standing Orders, under Section 16(1) read with Section 17. Section 16(2), however, notes as follows:

The Governing Board shall have the power to co-opt as members of any committee appointed under sub-section (1), such number of persons who are not members of the Governing Board as it may think fit, and the persons so co-opted shall have the right to attend the meetings of the committee, and take part in the proceedings of the committee, but shall not have the right to vote.

As members of Section 16 committees do not have voting rights, the implication is that they will have at least one or more members of the Governing Board. The implication of non-voting members in Section 16(2) and Rule 5 would mean, if we are right in our reading, that these committees cannot be constituted purely with non-governing board members, whether residents of Auroville, Secretary to the Foundation, independent experts or otherwise.

Committees – 'working groups' or by any other name – constituted by the Governing Board can under Section 16, in the discretion of the Board, be nominated and / or populated, fully or partly, by members of the Residents' Assembly, Working Committee or any other individual. Yet these members do not have voting rights. On the other hand, committees constituted by the Residents' Assembly under Section 19(3), '[f]or the purpose of carrying of its functions' and to interface with the Governing Board, can have voting residents and others.

There is historical uncertainty in this regard, as to which bodies fall within Section 16, with non-voting residents, and within Section 19, with voting residents and others, including the Secretary of the Foundation and other *ex officio* members. While the Finance Committee constituted under Section 5(1)(a) comprises, from the latest documents made available to us, four Governing Board members, the FAMC, TDC, LCC and others constituted under Section 5(1)(a) have exclusively non-Governing Board members. This is *prima facie* inconsistent with the language of Section 16. The precise legal basis for this practice is unclear and requires further examination.

Alongside, we note that the practice of accountability and reporting has been variable. In relation to the management of the Unity Fund, Mr. Sorabjee notes that it 'is significant that for the last over 15 years this Fund has been managed by Aurovilians alone and this practice has

⁹⁶ See, for example, Auroville Today, January 2017, No. 330, 19; March 2007, No. 217, 2; November 2005, No. 202, 6; January 2016, No. 318, 17.

⁹⁷ Auroville Today, May-June-July 2011, Nos. 263-4, 11.

not been doubted by any authority so far.⁹⁸ Yet the Secretary, drawing powers from the Governing Board, has historically prepared and verified the consolidated accounts.

In relation to the FAMC, in April 2016, the Residents' Assembly 'approved' a mandate, stating that the 'FAMC is appointed by and accountable to the Residents Assembly',⁹⁹ which also the formulation in rule 4(e) of the rules promulgated under the Act, notified by the Central Government. Yet, Rule 5(1)(b) identifies it as a Section 16 body, constituted by and accountable to the Governing Board. Given its membership of voting resident members, however, it is unclear, whether the FAMC is a Section 16 or Section 18 body.

In relation to the TDC, rule 8(a) of Standing Order 1/2019 and rule 6(1) of the Standing Order 1/2022, establishing the ATDC – L' Avenir explicitly note that 'the Council shall be accountable to the Governing Board' and 'keep the Auroville residents informed'.¹⁰⁰ In 2013, the Governing Board, Working Committee, TDC and TDC Advisory Group all agreed that the 'TDC should directly report to Governing Board and not to any intermediary body in-between ... [to] give sanctity to the time-lines indicated in TDC plans.'¹⁰¹ It is our understanding however that historically the *de facto* accountability has been towards the Residents' Assembly, to the extent those mechanisms were functional. Lastly, there is a tension between the 2017 Residents' Assembly TDC Terms of Reference and the 2019 Standing Order of the Governing Board, both in terms of the structuring of the TDC and accountability, which is yet unresolved.

The historical practice thus seems to be for a formal constitution by the Governing Board, at least for the TDC and FAMC, yet nomination and selection largely by the Residents' Assembly in line with its own processes. Insofar as accountability goes, there is again a dual, and often vaguely defined, system of reporting, with *de facto* immediate accountability to the Residents' Assembly, with the Governing Board's oversight, and lack of clarity *de jure*, with both the rules under the AVF Act, 1988 and internal documents remaining unclear on whether these bodies are constituted on Section 16 or 19, which is determinative of legal accountability. All that can perhaps be said in relation this administrative practice is that a collaborative approach was sought to be taken by the Governing Board and Residents' Assembly, leaving these issues consciously vague for sufficient leeway on both sides. While there is wisdom in this stance, it is perhaps better to clarify these matters within the framework of the AVF Act, 1988 and consider a practice of joint constitution under Section 16 read with Section 18, where appointment, accountability and reporting mechanisms can be clearly defined to avoid further uncertainty. Our proposals in Part IV may be read in this light.

ii. Clarification on Section 20(4)

For completeness, we note there is also a third route for the constitution of committees under the AVF Act by the Working Committee of the Residents' Assembly under Section 20(4):

The Working Committee may, with the approval of the Governing Board, create or constitute other organisations, trusts, societies or associations relatable to Auroville

⁹⁸ Sorabjee, 2008, 7-8.

⁹⁹ Funds and Assets Management Committee (FAMC) of the Residents Assembly 2016 Mandate, 2016, 3.

¹⁰⁰ Auroville Foundation, Standing Order 1/2019, 2019; Standing Order 1/2022, 2022.

¹⁰¹ Abha / Governing Board et. al., 2013, 4.

if the Working Committee is satisfied that such organisations, trusts, societies or associations have— (a) their headquarters at Auroville; (b) declared that in all matters relating to Auroville they shall act in conformity with the decisions of the Governing Board and that their main object is to promote the ideals laid down in the Charter of Auroville proclaimed by the ‘Mother’ on the 28th day of February, 1968.

The Working Committee, loosely akin to the outward-facing executive arm of the Residents’ Assembly, may create ‘such other organisations, trusts, societies or associations relating to Auroville.’ Facially, these bodies are not internal committees (working groups, or by any other name) but independent legal entities established under Indian law, to hold properties, assets or perform such tasks as may require such a corporate form to be established. Naturally, the constitution of such legally independent bodies, managing assets or performing functions concerning Auroville, would require the ‘approval’ of the Governing Board. We are informed that there is an understanding that Section 20(4) bodies can also be internal committees, i.e., Working Groups – whilst the text of the clause is ambiguous, the interpretive principle of *ejusdem generis* requires that the interpretation of general words which follow specified words be restricted to the same class as the specified words. The sub-clause specifies ‘trusts, societies and associations’, which are all independent corporate forms under the Societies Registration Act, 1860, the Indian Trusts Act, 1882 etc. The general word ‘organizations’ must therefore be read in this light.

In contrast, Section 16 and Section 19 committees are internal, possessing powers delegated to them by the Governing Board and Residents’ Assembly respectively. A harmonious interpretation of Sections 16, 19 and 20(4) in this context implies that the Working Committee can, as the executive of the Residents’ Assembly, and with the approval of the Governing Board, establish such *external* bodies as may be required, provided the conditions under sub-clause (a) and (b) are met. Indeed, these criteria – that their headquarters are in Auroville, and that their main object is to promote the ideals of Auroville – make sense only for bodies constituted outside the AVF Act. Internal committees will *ipso facto* meet these criteria. The purpose of Section 20(4) ‘organizations’ is thus distinct from ‘committees’ under Section 16 and Section 19. That said, Section 20(4) also demonstrates the *via media* approach of mutuality in practice: the Working Committee creates such bodies with the ‘approval’ of the Governing Board and is equally responsible to the Residents’ Assembly, which regulates its selection and removal.

As per our understanding, several trusts, within whose umbrella Auroville units are housed, were constituted under the Indian Trusts Act, 1882 and associated legislations, prior to the AVF Act, 1988 as corporate entities to conduct business and other activities. These trusts are independent legal entities, with individual Aurovilians as trustees; thirteen of these trusts are listed in the Schedule to the AVF Act, 1988 Act whose property and management came to vest in the Auroville Foundation under Sections 3 and 4. As the minutes of the 20th meeting of the Governing Board in August, 1999 note, all pre-existing trusts were re-registered under the Auroville Foundation.¹⁰² Subsequently, various other trusts have been established (we assume within the authority of Section 20(4)) – the Annual Report of the Auroville Foundation for

¹⁰² 20th Meeting of the Governing Board, 1999, 2-3.

2018-19 records 36 existing trusts.¹⁰³ We were unable, either through documents or interviews, to ascertain the precise legal status and operational necessity of such trusts – in that context, two points are relevant:

First, prior to the AVF Act, 1988, the establishment of trusts was required to provide a permanent corporate character to activities conducted by Aurovilians, especially in the background of the conflict with the Sri Aurobindo Society, to place all properties and management outside individual ownership or sole proprietorship, but in trust for Auroville (a yet undefined legal entity). The AVF Act, 1988 changes matters. It now provides a statutory umbrella for several of these activities, which may render the existence of some of these trusts unnecessary. It is therefore useful to review the necessity of independent trusts outside the AVF Act, 1988, keeping only those (in line with Section 20(4)) where an independent corporate entity is necessary for well-defined operational or strategic reasons. This is in addition to streamlining the trust-unit structure, discussed in Part III.

Second, the trustees of these bodies have naturally been changed over the years in line with internal selection practices of the FAMC. While executives of various units can be changed without altering the trust deed, a change in the trustees will ordinarily require procedures identified in the trust deed or the Indian Trusts Act, 1882, as is the case, to be met for legal effect. Internal processes within Auroville for a change of trustees must comply with these external processes, to avoid confusion and conflict at a later stage. We were unable to access the trust deeds, or to ascertain if this compliance practice is met (or if it is exempted owing to other provisions) from limited conversations with past members of the FAMC. This uncertainty is best resolved early. We are unaware if the systems and processes audit conducted by Ernst and Young, considered these aspects and if so, their findings on the issue.¹⁰⁴

iii. Mutuality and Dual Accountability

In sum, we note that the lack of clarity on accountability structures requires urgent action. This administrative practice, which has historically responded to the organic development of working groups to arrive at workable solutions, requires revisiting and careful reconsideration to rationalize and streamline bodies within the parameters of the AVF Act. The lack of clarity on the questions raised above has led, based on our interactions, to inefficiency in administrative processes owing to a confusion on reporting and decision-making structures. In this regard, the distinction between the ‘outward life’ and the ‘inner life,’ detailed by Sri Aurobindo, can help in mapping and revising the historical administrative practice concerning the appointment, voting rights and accountability of Working Groups under the AVF Act, and in doing so, resolve the tension between the spiritual substance, the ‘Divine anarchy’, and the legal form. Translating this into administrative terms, it may be worth adapting the known model of ‘light-form’ and ‘strong-form’ review of administrative actions: whereas the Governing Board can adopt a ‘light-form’ review of the ‘inner life’, it can adopt a ‘strong-form’ approval of the ‘outer life’. This seems, for example, to be the practice of Governing Boards in the past: for example, in its 20th meeting, the Governing Board, chaired by Professor Kireet

¹⁰³ Annual Report of the Auroville Foundation, 2018-19, 100-7.

¹⁰⁴ Minutes of 61st meeting of the Governing Board, 2022, 7.

Joshi, the drafter of the AVF Act, 1988 noted that its responsibility lay in monitoring / reviewing the work to keep it in accordance with the Charter, and that the creation of new trusts should or units was a joint responsibility it held with the Residents' Assembly:

The Board suggested that in future, a brief explanatory note on each trust or unit set up should be put up for the Board's perusal. The Governing Board was of the view that since they had the responsibility for all the Trusts and Units through the doctrine of constructive responsibility, they needed to closely monitor their functioning. Functioning of all the income generating Trusts/Units should be in accordance with the Charter of Auroville. In this context, it was felt that it is not desirable to set up Trusts unless the Resident's Assembly and the Governing Board were absolutely certain that the objects of the Trust will not eclipse the original vision and dilute the Charter of Auroville.¹⁰⁵

In this vein, as an example, we explore briefly the development of the Perspective Masterplan 2025, today within the remit of the TDC – L'Avenir. The work of city-development, insofar as it is the ground for the collective *karma* yoga, in Sri Aurobindo's formulation, the 'inner life' of the community. This is reflected in a reading of the AVF Act: the Residents' Assembly is tasked with the formulation of the Masterplan (under Section 19(c)), and it follows, the Detailed Development / Annual / Layout and Zonal Plans, which may be approved by the Governing Board (under Section 17(3)), subject to the International Advisory Council's duty (under Section 21(4)(b)) to ensure that the former 'are allowed the freedom to grow and develop activities and institutions.' The administrative practice in this area is instructive: the Residents' Assembly first formulated a draft Masterplan in 1999, which was subsequently reviewed by the Governing Board and returned with a request for amendment, in consultation with the TCPO thus ensuring the residents' freedom to grow and benefit from the Governing Board's regulation.¹⁰⁶ An executive body of the Residents' Assembly subsequently translated the 1999 Residents' Assembly draft Masterplan into the Perspective Masterplan 2025, finally approved by the Governing Board. This dialogic model is an example of a harmonious reading of these three provisions in Sri Aurobindo's schema. The executive body is subject to the 'assembly of freemen', with the wise counsel, regulation and appropriate pressure of the Governing Board, and with the independent Advisory Council ensuring, through its active monitoring and communications, compliance with the Charter on all sides.

Similarly, Standing Order 1/2019, as also 1/2011, makes the TDC accountable to the Governing Board, yet the majority of the membership has generally been through members nominated by the Residents' Assembly in accordance with its own mechanisms, with a nominee of the Governing Board to regulate and guide but not determine. Whilst this practice has not been sufficiently well-defined in the past and requires careful structuring to indicate the precise nature, format and timelines of accountability to the Governing Board and the Residents' Assembly (as we suggest in Part IV), this is in principle a model of dual accountability: *immediate accountability* to the Residents' Assembly (strong-form approval), thus providing

¹⁰⁵ Minutes of 20th meeting of the Governing Board, 1999, 3.

¹⁰⁶ See, Part III.A.

the collective with the space to fulfil its primary duty, and *oversight* by the Governing Board (light-form review) to guide and regulate.

This enjoins the Residents' Assembly to ensure timely action and address major challenges identified in Part IV, as their statutory freedom is not an exclusive license. The absence of such action would naturally lead to a sub-optimal and necessarily disharmonious relationship between the bodies, contrary to the spirit of mutuality underscored by Professor Joshi. In this scheme, executive bodies, i.e. the Working Groups, pertaining to the 'inner life', would be selected, populated and constituted by the Residents' Assembly (with nominees of the Governing Board, reporting back to it, to ensure a certain measure of independent accountability during the process). Indeed, they may be formally constituted by the Governing Board, as seems to have been the historical practice, yet the legal basis for this under Section 16 is unclear, as is the practical difficulty of constant oversight by the Governing Board in such cases. For the 'outer life', Working Groups relating to funds, properties, assets and law and order, monitoring and evaluation of settled targets, may be constituted by the Governing Board, with appropriate nominations from the Residents' Assembly and its Working Committee, but with a direct and regular accountability mechanism to the Board (strong-form approval).

In sum, we suggest that:

- i. this outline of a layered, yet clear, structure of accountability can be explored as an option for the future on the lines suggested in Part IV, with
- ii. Governing Board constituted committees for finance, land and asset management, legal compliance and other related areas, with one or more Governing Board members and others non-voting,
- iii. a clearly defined protocol for interface – sharing of information and regular work updates – between the Governing Board and Residents' Assembly through the Working Committee, for the latter to benefit from the Board's wisdom and to act as an effective guide and check, and
- iv. a commonly constituted Steering Group comprising members of all three bodies, tasked with monitoring and evaluation, to ensure the accountability of the Working Groups.

*

F. THE LIMITS OF LAW

In sum, the long and protracted battle leading to the AVF Act, and indeed, subsequent frictions between the bodies at various stages, are attempts at replacing Mother's direct guidance in the physical. The question the AVF Act seeks to answer is not after Mother, *who*, but after Mother, *how*?

The AVF Act offers a unique model for other communities and corporate bodies, but its replicability will depend in large part on the conventions of practice adopted by members of the Auroville community across the three pillars. For Auroville to be an exemplar of the approach Sri Aurobindo outlined, the practice of the AVF Act must closely adhere to his careful formulation and be mindful of the challenges and pitfalls, across each body – 'each of these respective tasks has an integrity of its own.'¹⁰⁷

In the final analysis, no legal framework, no matter how carefully drafted, can replace a harmonious and trust-based 'mutuality' amongst the bodies. This is all the more so as Professor Joshi's careful drafting of the AVF Act has a *necessary* ambiguity that accentuates this difficulty: in his understanding, the authority of both the Governing Board and the Residents' Assembly is limited by the Charter, and 'full freedom can be exercised [by either body] provided it is within the confines of the Charter and the vision defined for Auroville by the Mother.'¹⁰⁸ But the Charter (as we discussed in Part I) is a manifesto of values that does not immediately render clear answers – it requires further specification and interpretation to translate its commitments to particular situations, in light of Mother and Sri Aurobindo's detailed guidance and substantial learnings in political and organizational theory and practice since. This leads to a natural, and in the ordinary course, healthy diversity of opinions. Yet, when they are not resolved, as is often the case, divergent interpretations may each claim adherence to Mother's ideal and without any final, authoritative arbiter on what the Charter *actually* means in the context of that disagreement, the institutional architecture of the AVF Act cannot offer water-tight solutions. This tension figured in Professor Joshi's suggestion that the International Advisory Council has the power to 'knock down' a decision of the Governing Board if it does not comport with the Charter (a quasi-judicial power of sorts), but the text of the legislation drafted by him does not incorporate this view:

All forms of government that have been formed in the history of the world are forms where some kind of rulership is attributed to some authority outside the individual. If therefore you have an Act in which the individuals constituting the totality have the freedom to grow, and if it is laid down in the Act itself that this freedom is to be ensured, the residents of Auroville should feel free and if any attempt is made to curb this freedom, then there is a provision in the Act itself of an authority whose very duty it is to advise the Governing Board in such a way that this freedom is not curbed.¹⁰⁹

¹⁰⁷ Waldron, 2016, 66.

¹⁰⁸ Auroville Tomorrow, Issue 4, 9.

¹⁰⁹ Joshi, 1999, 8.

Rather, Professor Joshi's careful tripartite system reflects a system of checks and balances that modern constitutional systems incorporate (absent the limb of a judicial forum) – this structure is primarily oriented to *avoid* concentrations of power, either in the legislative majority or an executive minority.¹¹⁰ It sets a floor minimum. While in times of harmony, it allows for a mutuality, or at times, a useful creative friction, in times of tension, it backstops an appropriate balance to avoid an exclusive concentration of powers:

To form a moderate government, it is necessary to combine the several powers; to regulate, temper, and set them in motion; to give, as it were, ballast to one, in order to enable it to counterpoise the other.¹¹¹

Such constitutional machineries as the AVF Act can at best prevent backsliding, but cannot ensure progress along the lines of the Charter. Resolving the interpretive ambiguities of the AVF Act is important, but it would be incorrect to think that this can secure Auroville's political ideal. The limits of the law are only too well known – Sri Aurobindo makes this point explicit:

Constitutions can only disguise facts, they cannot abrogate them: for whatever ideas the form of the constitution may embody, its working is always that of the actually realised forces which can use it with effect.¹¹²

Similarly, Madison's discourse on the separation of powers in *The Federalist Papers* notes:

Ambition must be made to counteract ambition ... It may be a reflection on human nature, that such devices [checks and balances] should be necessary to control the abuses of government. But what is government itself, but the greatest of all reflections on human nature? If men were angels, no government would be necessary.¹¹³

To conclude, although the AVF Act was the result of an unfortunate and perhaps avoidable historical conflict, it provides an appropriate, or as best as possible, administrative vessel that can allow the progressive development of Mother's vision of the 'Divine anarchy'. It facilitates but cannot secure Auroville's ideal – this requires all three constituent bodies to work in unison, cemented by a common aspiration that alone can allow for the descent. Under the AVF Act, Auroville belongs to nobody – it is in the primary trusteeship of the Residents' Assembly, with the Governing Board and International Advisory Council ensuring, in the wisdom and power of their respective domains, that the *dharma* of Auroville, Mother's Charter, remains supreme.

*

¹¹⁰ See, Waldron, 2013.

¹¹¹ Montesquieu in Waldron, 2016, 21, *see also*, Waldron, 2016, 29-34.

¹¹² Sri Aurobindo, CWSA, 1977, Vol. 25, 400.

¹¹³ See, Waldron, *Political Political Theory* (Harvard University Press, 2016), 2, *passim*.

CONCLUDING NOTES

Till that is reached our journeying cannot cease.

Sri Aurobindo, *Savitri*

The city already exists.

Mother, April 23, 1966, *Agenda*

This is a framework study that paints a broad-picture perspective of Auroville's vision, growth and development, identifying key areas of progress and challenges for the future. In doing so, we navigate between Mother and Sri Aurobindo's ideals, understood in the background of global movements, outlined in Parts I and II, and the empirical picture, outlined in Part III. The spiritual ideal, represented not just symbolically, but physically, in the concentration of Mother's force palpable in the Matrimandir – the construction of which represents a singularly important achievement for Auroville – served as a constant reminder of the path to be trod.

While great progress has been made in establishing the physical base for the city by pioneering and exemplary green works over the past fifty years, with a notable outreach architecture in the bio-region, the vital infrastructure – represented in services, housing, economy etc. – and mental infrastructure – represented in governance frameworks, research and collective planning, institutional coordination etc. – are works in progress, proceeding unsystematically at a rather slow pace. While there are a number of widely acclaimed enterprises developed through individual initiative, collectively, the records show a stagnation, or creative inertia, particularly in urban infrastructure development, socio-economic planning and population growth. Many opportunities have been missed in the process. This is particularly so since the 2001 Perspective Masterplan – most development goals in the document are yet to be met, and in some sectors, work is yet to start. The causes for this stagnation are varied, from ability (lack of funding, human resources and expertise) to willingness (adherence to the *status quo*, altered incentive structures to build and a dilution of the vision) and prolonged internal disagreements, demonstrating a lack of unity. As Ghisi perceptively noted in 2010:

The first strength of Auroville is that it is still there ... [but] this big light also has a shadow side of a comparable size.¹

It would be naïve to think that the imperfections of human nature, our characteristic humours and tempers, would not be reflected in Auroville's collective: quite to the contrary, Auroville must contain a vast catalogue of problems, representative of our collective ills, for it to be the 'city the Earth needs.' This play of light and shadow is a constitutive feature of Auroville's evolutionary game:

There is a purpose in each stumble and fall;
Nature's most careless lolling is a pose
Preparing some forward step, some deep result,
Ingenious notes plugged into a motived score,

¹ Ghisi, 2010, 25.

These million discords dot the harmonious theme
Of the evolution's huge orchestral dance.²

Auroville's establishment, early pioneering efforts and indeed its continued existence despite formidable challenges are a miracle. This owes to a host of Aurovilians whose boldness, imagination and selfless dedication to the work serve to inspire. Yet, as in any project of this scale and ambition, it is one that requires a rejuvenation to prepare for the next stage of growth.

To that end, Part III examines the governance trajectory across sectors. What emerges is that Auroville is still at a nascent stage in its governance trajectory. The culture of small-group democracy, necessary and valuable in the early years, yields in several sectors to a semi-autarchic operation of nodes, with a loosely defined relationship between sub-systems and an unclear distinction between legislative and executive mechanisms. In this, on paper mechanisms appear to have a loose relationship with practice, resulting in accountability concerns and a relative dissipation of energies with individual initiative operating outside of a cohesive planning and policy framework that can guide energies. The imperative of city-building at scale and complexity, in anticipation of increasing numbers, will require a careful recalibration to allow for effective decision-making and implementation. A restructure of organizational and governance forms and processes is thus necessary, to equip Auroville to adequately ground the next stage of growth. This is so across the legislative domain of the Residents' Assembly and the executive domain of Working Groups, with a light but tight regulatory frame backed by carefully defined, firm and sensitive enforcement mechanisms. A centralizing corrective to allow for coordinated and effective city-wide action is merited, with a clarification and strengthening of the executive mandate of Zonal Groups. Alongside, an articulation of the sub-zonal architecture will be valuable as numbers grow to allow for manageable, effective and meaningful participation, with devolved action along the principle of subsidiarity. Accordingly, Part IV suggests pathways for reform. These include:

- i. Defined procedural rules for channelized and informed decision-making within a bicameral Residents' Assembly divided between a Council of Residents and a Council of the Wise.
- ii. Developing confederated decision-making models at the sub-zonal and zonal levels, with subsidiarity-based financial allocations for zonal action.
- iii. Strengthening the executive mandate of the Zonal Groups and sub-zonal bodies (Zonal Groups, SAIIER, ABC, ABS etc.) and the creation of legislative Zonal Assemblies.
- iv. Developing an independent channel in the 'Unity Committee' for evaluation and monitoring, with a commonly constituted Steering Group across the three statutory bodies for external evaluation and monitoring.
- v. Restructuring the selection, operation and evaluation mechanisms of Working Groups for expert-led and expert-constituted bodies as opposed to a popular vote under the

² Sri Aurobindo, CWSA, 1997, Vols. 33-34, 658.

- Participatory Working Groups Selection Guidelines, with provisional selection contingent on drafting a commonly-agreed upon work plan.
- vi. A restructuring of the current mandates of the TDC, FAMC and other Working Groups for manageable, efficient and accountable working.
 - vii. Extending Working Group term limits, for policy and institutional continuity.
 - viii. Developing defined, robust and time-bound community consultation platforms to allow for effective, meaningful and accountable participation, with decision-making resting with the Working Group / Zonal Group in case of disagreement or undue delay along the principle of ‘illuminated hierarchies.’
 - ix. A defined separation of legislative and executive powers as between the Residents’ Assembly and Working Groups / Zonal Groups.
 - x. Developing a common administrative, managerial and human resources pool for Working Groups / Zonal Groups.
 - xi. Instituting advisory boards for each Working Group to leverage external expertise, with reporting mechanisms to the Unity Committee for external mid-term accountability.
 - xii. Developing a city-wide continuous digital learning platform embedded in each sector for learning and informed decision-making.
 - xiii. Developing a tiered, easy access dispute resolution mechanism.
 - xiv. Rationalizing / streamlining / codifying policies, codes of conduct, regulations, rules, office and standing order, customs in plain language.
 - xv. Developing a city-wide governance dashboard with integrated enterprise resource planning and an independent data management and statistics service for evidence-led planning, implementation and review.

Equally, as we discuss in Part V, a spirit of mutuality between the three statutory bodies, the Residents’ Assembly, Governing Board and International Advisory Council, is indispensable for the effective action of the Foundation. While the Auroville Foundation Act, 1988 places the primary trusteeship of Auroville in the Residents’ Assembly, it guardrails this autonomy with the oversight of the Governing Board assisted by the independent counsel of the International Advisory Council. This system of checks and balances encoded in the legislation backstops an exclusive concentration of power in any single body, a legal translation of the Charter’s commitment that Auroville ‘belongs to nobody in particular’. In Sri Aurobindo’s scheme, friction between the bodies is inevitable, as recent events indicate, until each attends to its *dharma*, with correctives and swings expected in case that does not obtain. We accordingly suggest institutional reforms that may secure a dynamic equilibrium, necessary for the peaceful and harmonious manifestation of the city. These include the constitution of a Steering Group, a clarification of how Section 16 and 18 bodies are constituted and the institution of a practice of dual, yet distributed, accountability to the Governing Board and Residents’ Assembly.

Constructing a city dedicated to the Divine is the work of an age – the great efforts of the past that have brought Auroville to where it is today are a springboard to the ‘great adventure’ of the future.³ The pioneering days, particularly with Mother at the helm, placed Auroville at the *avante-garde*, materially and spiritually. But this status is not guaranteed today. Much remains to be done in all sectors, and in many, beginnings are yet to be made. This view was shared by many in the community: ‘there is a tremendous thirst for change, for movement forward based upon our ideals.’⁴ We were met in conversations with a refreshing and timely self-reflective poise that Auroville is at an inflection point for the next stage of its growth – it needs a conscious re-alignment with the vision where deviations or dilutions have occurred. Renewed energy and idealism matched with concrete and practical steps for this next stage can allow for a conscious gathering of energies to propel the city forward.

Building Mother’s city is a difficult and joyous task, ‘rich with life’s adventure and delight’, much as was the construction of the Matrimandir – the majestic spiritual vision, a culmination of terrestrial evolution through the descent of the Supramental, is at once irresistible in its logic yet elusive to our immediate grasp, and the mode of practice disarmingly simple yet demanding. For this, Auroville must naturally tailor-make its own developmental model through robust research and experimentation. Yet, it seems to be in a prolonged intermediate stage where the old has been rejected, but the new is yet to be found. In this, inertia and timidity have settled in. An openness to developments elsewhere, a cross-fertilization with emerging streams of thought, as also an invitation for others to participate and bring fresh energy into the system, is helpful to move the city forward. and importantly, avoid entrenchment and an unhelpful negative self-definition (‘we are not what the others are’). As is the vitality of bold actions and experimentation, to ‘grow ... with the full play of the unexpected’, offered in an aspiration to the ideal, which ‘builds in ignorance the steps of light’.⁵ This spirit of undeterred and intense action, whether it leads to immediate success or failure, is the material offering for the growth of the inner flame of Auroville:

Failures must be originally numerous in everything great and difficult, but the time comes when the experience of past failures can be profitably used and the gate that so long resisted opens.⁶

The point, as Mother often noted, is to make the attempt, ‘with all the unforeseen events, the risks, the hazards it entails ... And – come what may!’.⁷ There is perhaps no better inspiration than the unhindered promise and vitality infused in these lines of *Savitri*:

The nude god-children in their play-fields ran
Smiting the winds with splendour and with speed;
Of storm and sun they made companions,
Sported with the white mane of tossing seas

³ As Moter said: ‘There are people who love adventure. It is these I call, and I tell them this: ‘I invite you to the great adventure.’ Guigan, 2018, Vol. 1, 65.

⁴ Full Report, Auroville Retreat, 2015, 14.

⁵ Guigan, 2018, Vol. 1, 217; Sri Aurobindo, CWSA, 1997, Vols. 33-34, 76.

⁶ Sri Aurobindo, CWSA, 1997, Vol. 25, 266.

⁷ Guigan, 2018, Vol. 1, 65.

Slew distance trampled to death under their wheels
And wrestled in the arenas of their force.⁸

In this spirit, while off-the-shelf solutions may not be apparent in all sectors, immediate actions need not be held hostage: ‘the motto of the aspirant’s endeavour must be the *solvitur ambulando* of the discoverer. For by the doing the difficulty will be solved.’⁹ In this vein of solving by doing – and not talking – discrete projects that generate broad, even if not uniform, consensus can be acted upon immediately and with a sense of urgency to generate a helpful momentum. We have identified these sector-wise in Part III of this study. Many of these are not new – they have been suggested by previous studies going back to the Masterplan and indeed, in some cases, to works proposed by Mother.

It was telling that most discussants agreed to most development priorities and urged strong action. Yet, a common feature across our research was a lack of unity, a frustration with the collective and a felt blocking of energies, almost arithmetically so with each idea receiving an equal and opposite pull. This is not a new problem – in a long conversation dated March, 1972, Mother diagnosed the problem and suggested a cure:

Yes, yes, yes – yes, exactly. Exactly! Instead of a combination where each one has his place within a harmonious unity, instead of that, everyone pulls in his own direction ... You have hit the point: lack of unity is the cause of all the difficulties ...¹⁰

Auroville is ‘decreed’ and ‘success is certain.’ But ‘on one condition’ – ONE condition’:

... that we become united. Supposedly, we are preaching unity to the world – it would be only decent to do it ourselves! Instead, we are the example of exactly the opposite. To visitors we say, ‘Here we seek human unity’; but WE constantly quarrel among ourselves, and we preach human unity! That’s absurd. Totally absurd! We can’t even be ONE in our own work.¹¹

Resolving these contrary pulls is inevitable in Sri Aurobindo’s evolutionary scheme of things – the question is whether Auroville does it swiftly or slowly, with more or less pain in the process. Recent disagreements over the city’s governance, many of which are before the courts, have divided the community and surfaced latent tensions for resolution. This churn, painful and unsettling for many, presents an opportunity, an infusion of energy to reflect on past problems and ‘spring boldly to the future’ together – ‘if the heart were not forced to want and weep / his soul would have lain down content, at ease.’¹² As Sri Aurobindo reminds us:

Often the decisive turn is preceded by an apparent emphasising and raising to their extreme of things which seem the very denial, the most uncompromising opposite of the new principle and the new creation.¹³

⁸ Sri Aurobindo, CWSA, 1997, Vols. 33-34, 126.

⁹ Sri Aurobindo, CWSA, 1997, Vol. 25, 266.

¹⁰ Guigan, 2018, Vol. 2, 331.

¹¹ Guigan, 2018, Vol. 2, 332.

¹² Sri Aurobindo, CWSA, 1997, Vols. 33-34, 442.

¹³ Sri Aurobindo, CWSA, 1997, Vol. 25, 183.

To conclude, we note that Mother once said that Auroville has ‘the possibility of a breathtaking success.’¹⁴ This possibility, unrealized still, can be palpably felt in the atmosphere. As urbanization peaks and the evolutionary crisis deepens, the world needs a city like Auroville to lead the New Creation. Manifesting it requires a collective effort, a bold and playful one, for which finding that unity and fraternity is now key.

Rich-hearted, wonderful to each other met
In the mutual marvelling of their myriad notes
And dwelt like brothers of one family
Who had found their common and mysterious home.¹⁵



¹⁴ Guigan, 2018, Vol. 2, 258.

¹⁵ Sri Aurobindo, CWSA, 1997, Vols. 33-34, 682.

BIBLIOGRAPHY

References are organized under the following six themes: governance and organization, planning, land and housing, education and research, environment and ecology, outreach and miscellaneous. Documents in each theme are referenced under the following six heads: books, articles, reports, correspondence and administrative documents, legislative material and maps, drawings and planning documents.

A. Governance and Organization

Books

1. Allan, T.R.S. 'Legislation and the Common Law.' Chapter. In *Law, Liberty, and Justice: The Legal Foundations of British Constitutionalism*, 79–108. Oxford, England: Oxford University Press, 1994.
2. Aurobindo, Sri. *Aphorisms*. Auro E-Books. Pondicherry: Sri Aurobindo Ashram Publication Department, n.d. <https://auro-ebooks-in.s3.ap-south-1.amazonaws.com/book-uploads/Sri-Aurobindo-Aphorisms.pdf>.
3. Aurobindo, Sri. *Early Cultural Writings*. Vol. 1. *The Complete Works of Sri Aurobindo* Pondicherry, India: Sri Aurobindo Ashram Publication Department, 1997 [CWSA]. Vols. 6-7. *Bande Matram: Political Writings and Speeches 1890–1908*. Vol. 8. *Karmayogin*. Vol. 12. *Essays Divine and Human: Writings from Manuscripts (1910-1950)*. Vol. 15. *The Secret of the Veda*. Vol. 17. *Isha Upanishad*. Vol. 20. *The Renaissance in India and Other Essays on Indian Culture*. Vol. 25. *The Human Cycle, Ideal of Human Unity and War and Self-Determination*. Vol. 26. *The Future Poetry*. Vol. 28. *Letters on Yoga I*. Vol. 29. *Letters on Yoga II*. Vol. 30. *Letters on Yoga III*. Vol. 31. *Letters on Yoga IV*. Vol. 32. *The Mother with Letters on the Mother*. Vol. 35. *Letters on Himself and the Ashram*. Vol. 36. *Autobiographical Notes and Other Writings of Historical Interest*. Vols. 21-22. *The Life Divine*. Vols. 23-24. *The Synthesis of Yoga*. Vols. 33-34. *Savitri*.
4. Aurobindo, Sri. *The National Value of Art*. Pondicherry: Sri Aurobindo Ashram, 1922.
5. Aurobindo, Sri. *Sri Aurobindo to Dilip: 1936-1937*. Edited by Sujata Nahar, Michel Danino, and Shankar Bandyopadhyay. 1st ed. Vols. 1 & 3. Pune, Maharashtra: Hari Krishna Mandir Trust: Mysore Mira Aditi, 2003.
6. Avineri, Shlomo, and Avner De-Shalit, eds. *Communitarianism and Individualism*. Oxford, United Kingdom: Oxford: Clarendon Press, 1992.
7. Baland, Jean-Marie, and Jean-Philippe Platteau. 'The Tragedy of the Commons.' Chapter. In *Halting Degradation of Natural Resources: Is There a Role for Rural Communities?*, 25–35. Oxford, England: Oxford University Press, 2000.
8. Baldwin, Robert, Martin Cave, and Martin Lodge, eds. *The Oxford Handbook of Regulation*. Oxford Academic. Oxford, England: Oxford University Press, 2010.
9. Baldwin, Robert, Martin Cave, and Martin Lodge. *Understanding Regulation: Theory, Strategy, and Practice*. Oxford Academic. 2nd ed. Oxford, England: Oxford University Press, 2011.
10. Barak, Aharon. *Purposive Interpretation in Law*. Translated by Sari Bashi. New Jersey, United States: Princeton University Press, 2007.

11. Barry, Brian. 'Public Interest.' Chapter. In *Political Philosophy*, 112–126. Oxford, England: Oxford University Press, 1967.
12. Bederman, David J. *Custom as a Source of Law. Cambridge Core*. Cambridge, England: Cambridge University Press, 2012.
13. Berlin, Isaiah. 'Two Concepts of Liberty.' Essay. In *Four Essays on Liberty*, 166–217. London, United Kingdom: Oxford University Press, 2002.
14. Bertou, Eri, and Daniele Caramani, eds. *The Technocratic Challenge to Democracy*. Oxfordshire, England: Routledge, Taylor & Francis Group, 2020.
15. Brandsma, Gijss Jan, and Johan Adriaensen. 'The Principal–Agent Model, Accountability and Democratic Legitimacy.' Chapter. In *The Principal Agent Model and the European Union*, edited by Tom Delreux and Johan Adriaensen, 35–54. Palgrave Studies in European Union Politics. London, England: Palgrave Macmillan Cham, 2017.
16. Carey, John M. 'Legislative Organization.' Chapter. In *The Oxford Handbook of Political Institutions*, edited by Sarah A. Binder, R. A. W. Rhodes, and Bert A. Rockman, 431–54. Oxford, England: Oxford University Press, 2008.
17. Certoma, Chiara, and Francesco Rizzi. 'Crowdsourcing Processes for Citizen-Driven Governance.' Chapter. In *Citizen Empowerment and Innovation in the Data-Rich City*, edited by Chiara Certoma, Francesco Rizzi, Mark Dyer, and Lorena Pocatilu, 57–77. Springer Tracts in Civil Engineering. Springer Cham, 2017.
18. Chakraborty, Pinaki, Lekha Chakraborty, and Anit Mukherjee. 'Decentralization in India: History, Laws and Politics.' Chapter. In *Social Sector in a Decentralized Economy: India in the Era of Globalization*, 24–44. Cambridge, England: Cambridge University Press, 2017.
19. Cheema, G. Shabbir, and Dennis A. Rondinelli, eds. *Decentralizing Governance: Emerging Concepts and Practices*. Brookings Institution Press, 2007.
20. Chomsky Noam and Barry Pateman. 2005. *Chomsky on Anarchism*. 1st ed. Oakland CA: AK Press.
21. Christiano, Thomas. 'Disagreement and the Justification of Democracy.' Essay. In *The Cambridge Companion to Liberalism*, edited by Steven Wall, 237–60. Cambridge, England: Cambridge University Press, 2015.
22. Chrostowska, S. D., and James D. Ingram, eds. *Political uses of Utopia: New Marxist, Anarchist, and Radical Democratic Perspectives*. New York, United States: Columbia University Press, 2017.
23. Clarence-Smith, Suryamayi. 'Towards a Spiritualised Society: Auroville, an Experiment in Prefigurative Utopianism'. *University of Sussex*, December 18, 2019.
24. Cox, Gary W. 'The Organization of Democratic Legislatures.' Chapter. In *The Oxford Handbook of Political Economy*, edited by Donald A. Wittman and Barry R. Weingast, 141–61. Oxford, England: Oxford University Press, 2008.
25. Cristiano, Thomas. 'Disagreement and the Justification of Democracy.' Chapter. In *The Cambridge Companion to Liberalism*, edited by Steven Wall, 237–60. Cambridge, England: Cambridge University Press, 2015.
26. Crouch, Colin. *Post-Democracy: A Sociological Introduction (Themes for the 21st Century)*. 1st ed. Cambridge, England: Polity Press, 2004.

27. Davies, Andrew. 'Envisioning a Spiritual and Cosmopolitan Decolonial Future? Sri Aurobindo's 'Non-Political' Anticolonialism.' Chapter. In *Geographies of Anti-Colonialism: Political Networks Across and Beyond South India, c. 1900-1930*, 115–36. New Jersey, United States: Wiley & Sons, 2019.
28. Dolgoff, Sam, ed. *The Anarchist Collectives: Workers' Self-Management in the Spanish Revolution (1936-1939)*. Montreal, Canada: Black Rose Books, 1973.
29. Dovi, Suzanne. 'Hanna Pitkin, The Concept of Representation.' Chapter. In *The Oxford Handbook of Classics in Contemporary Political Theory*, edited by Jacob T. Levy. Oxford, England: Oxford University Press, 2015.
30. Dovi, Suzanne. *The Good Representative*. New York, United States: Wiley, 2007.
31. Dupuis-Déri, Francis. 'Anarchy in Political Philosophy.' Chapter. In *New Perspectives on Anarchism*, edited by Nathan J. Jun and Shane Wahl, 9–23. Maryland, United States: Lexington Books, 2009.
32. Egeberg, Morten, and Jarle Trondal. *An Organizational Approach to Public Governance: Understanding and Design*. Oxford, England: Oxford University Press, 2018.
33. Elgin, Catherine Z. 'Persistent Disagreement.' Chapter. In *Disagreement*, edited by Richard Feldman and Ted A. Warfield, 53–68. Oxford, England: Oxford University Press, 2010.
34. Expressio Unius Est Exclusio Alterius. In *Black's Law Dictionary*. Minnesota, United States: West Publishing Co., 1998.
35. Fischer, Frank. *Democracy and Expertise: Reorienting Policy Inquiry*. Oxford Academic. Oxford, England: Oxford University Press, 2009.
36. Foster, Sheila R., and Christian Iaione. 'Ostrom in the City: Design Principles and Practices for the Urban Commons.' Essay. In *Routledge Handbook of the Study of the Commons*, edited by Blake Hudson, Jonathan Rosenbloom, and Dan Cole, 1st ed., 235–55. London, England: Routledge, 2019.
37. Frazer, Michael L. *The Enlightenment of Sympathy: Justice and the Moral Sentiments in the Eighteenth Century and Today*. London, United Kingdom: Oxford University Press, 2010.
38. Freeman, Samuel. 'Social Contract Approaches.' Chapter. In *The Oxford Handbook of Political Philosophy*, edited by David Estlund, 133–51. Oxford, England: Oxford University Press, 2012.
39. Gay, Paul du. "'A Pause in the Impatience of Things': Notes On Formal Organization, the Bureaucratic Ethos, and Speed.' Chapter. In *The Sociology of Speed: Digital, Organizational, and Social Temporalities*, edited by Judy Wajcman and Nigel Dodd, 86–101. Oxford, England: Oxford University Press, 2016.
40. George, Robert P. 'Individual Rights and Collective Interests: Dworkin on 'Equal Concern and Respect.' Chapter. In *Making Men Moral: Civil Liberties and Public Morality*. Oxford University Press, 1995.
41. George, Robert P. *Making Men Moral: Civil Liberties and Public Morality*. Oxford Academic. Oxford, England: Oxford University Press, 1995.
42. Guigan, Gilles. *Auroville in Mother's Words*, 2 vols. Auroville: Auroville Press Publishers, 2018.

43. Gunningham, Neil, and Darren Sinclair. 'Smart Regulation.' Chapter. In *Regulatory Theory: Foundations and Applications*, edited by Peter Drahos, 133–48. Canberra, Australia: ANU Press, 2017.
44. Gutmann, Amy, and Dennis F. Thompson. *Why Deliberative Democracy?* New Jersey, United States: Princeton University Press, 2004.
45. Hendriks, Frank. 'Participatory Democracy: All Together Now.' Chapter. In *Vital Democracy: A Theory of Democracy in Action*, 107–32. Oxford, England: Oxford University Press, 2010.
46. Kant, Immanuel. *Kant: Political Writings*. Edited by H. S. Reiss. Translated by H. B. Nisbet. 2nd ed. Cambridge, England: Cambridge University Press, 1991.
47. Kehoe, Jerard, Steven Brown, and Calvin C. Hoffman. 'The Life Cycle of Successful Selection Programs.' Chapter. In *The Oxford Handbook of Personnel Assessment and Selection*, edited by Neal Schmitt, 903–36. Oxford, England: Oxford University Press, 2012.
48. Kinna, Ruth. 2016. 'Anarchism: Utopian and Scientific.' Chapter. In *Kropotkin: Reviewing the Classical Anarchist Tradition*, 127–54. Edinburgh University Press.
49. Kraut, Richard. 'Plato against Democracy: A Defense.' Chapter. In *Virtue, Happiness, Knowledge: Themes from the Work of Gail Fine and Terence Irwin*, edited by David O. Brink, Susan Sauvé Meyer, and Christopher Shields, 77–96. Oxford, England: Oxford University Press, 2018.
50. Krick, Eva. 'Stopping Rules in Political Settings.' Chapter. In *Expertise and Participation: Institutional Designs for Policy Development in Europe*, 163–94. Palgrave Studies in European Political Sociology. Cham, Germany: Palgrave Macmillan, 2021.
51. Landemore, Hélène. Manuscript. *Rousseau's Mistake: Representation and the Myth of Direct Democracy*. New Haven, 2016.
52. Levi-Faur, David. *The Oxford Handbook of Governance*. Oxford Academic. Oxford, England: Oxford University Press, 2012.
53. Levy, Jacob T. 'Against Fraternity: Democracy without Solidarity.' Chapter. In *The Strains of Commitment: The Political Sources of Solidarity in Diverse Societies*, edited by Keith Banting and Will Kymlicka, 107–24. Oxford, England: Oxford University Press, 2017.
54. Lodge, Martin, and Lindsay Stirton. 'Accountability in the Regulatory State.' Chapter. In *The Oxford Handbook of Regulation*, edited by Robert Baldwin, Martin Cave, and Martin Lodge, 349–70. Oxford, England: Oxford University Press, 2010.
55. Lukacs, Georg. *The Destruction of Reason*. Delhi, India: Aakar Books, 2016.
56. Mansbridge, Jane J. "The Rise and Fall of Self-Interest in the Explanation of Political Life." Chapter. In *Beyond Self-Interest*, edited by Jane J. Mansbridge, 3–22. Chicago, United States: University of Chicago Press, 1990.
57. March, James G., and Johan P. Olsen. 'Elaborating the 'New Institutionalism.' Chapter. In *The Oxford Handbook of Political Science*, edited by Robert Goodin, 159–75. Oxford, England: Oxford University Press, 2011.
58. Marcuse, Herbert. *One-dimensional Man: Studies in Ideology of Advanced Industrial Society*. 2nd ed. Boston: Beacon Press, 1991.

59. Martin, Shane, Thomas Saalfeld, and Kaare W. Strøm, eds. *The Oxford Handbook of Legislative Studies*. Oxford Academic. Oxford, England: Oxford University Press, 2014.
60. Martin, Shane. 'Committees.' Chapter. In *The Oxford Handbook of Legislative Studies*, edited by Shane Martin, Thomas Saalfeld, and Kaare W. Strøm, 352–68. Oxford, England: Oxford University Press, 2014.
61. Mason, Andrew. *Community, Solidarity and Belonging: Levels of Community and their Normative Significance*. Cambridge Core. Cambridge, England: Cambridge University Press, 2009.
62. Metzger, Gillian E. 'Legislatures, Executives, and Political Control of Government.' Chapter. In *The Oxford Handbook of Comparative Administrative Law*, edited by Peter Cane, Herwig C. H. Hofmann, Eric C. Ip, and Peter L. Lindseth, 696–720. Oxford, England: Oxford University Press, 2020.
63. Mill, John Stuart. *Considerations on Representative Government*. *Great Books in Philosophy*. Buffalo, New York, United States: Prometheus Books, 1991.
64. Mill, John Stuart. *On Liberty, Utilitarianism, and Other Essays*. Edited by Mark Philp and Frederick Rosen. Oxford, England: Oxford University Press, 2015.
65. Morrison, Donald R. 2007. 'The Utopian Character of Plato's Ideal City.' Chapter. In *The Cambridge Companion to Plato's Republic*, edited by G. R. F. Ferrari, 232–55. Cambridge Companions to Philosophy. Cambridge: Cambridge University Press.
66. Mother, The. *Notes on the Way*. Vol. 11 of *Collected Works of the Mother (CWM)*. Pondicherry, India: Sri Aurobindo Ashram, 2002.
67. Mother. *Collected Works of The Mother: Words of the Mother-I*. Vol. 13. Pondicherry, India: Sri Aurobindo Ashram, 2004.
68. Müller, Wolfgang C., and Ulrich Sieberer. 'Procedure and Rules in Legislatures.' Chapter. In *The Oxford Handbook of Legislative Studies*, edited by Shane Martin, Thomas Saalfeld, and Kaare W. Strøm, 311–31. Oxford, England: Oxford University Press, 2014.
69. Mujherjee, Nirmalaya. *Auroville, A Dream Highjacked*. Kolkata, India: Truth and Courage, 2019.
70. Murphy, James Bernard. 'Habit and Convention at the Foundation of Custom.' Chapter. In *The Nature of Customary Law: Legal, Historical and Philosophical Perspectives*, edited by Amanda Perreau-Saussine and James B. Murphy, 53–78. Cambridge, England: Cambridge University Press, 2009.
71. Norris, Pippa. *Democratic Deficit: Critical Citizens Revisited*. Cambridge, England: Cambridge University Press, 2011.
72. Nozick, Robert. *Anarchy, State, and Utopia*. 2nd ed. New York, United States: Basic Books, 2013.
73. Page, Edward C. 'The Origins of Policy.' Chapter. In *The Oxford Handbook of Public Policy*, edited by Robert Goodin, Michael Moran, and Martin Rein, 207–27. Oxford, England: Oxford University Press, 2008.
74. Palmer, Donald, Nicole Biggart, and Brian Dick. 'Is the New Institutionalism a Theory?' Chapter. In *The SAGE Handbook of Organizational Institutionalism*, edited

- by Royston Greenwood, Christine Oliver, Roy Suddaby, and Kerstin Sahlin, 738–68. California, United States: SAGE Publications Ltd, 2008.
75. Pettit, Philip. ‘Rousseau’s Dilemma.’ Chapter. In *Engaging with Rousseau: Reception and Interpretation from the Eighteenth Century to the Present*, edited by Avi Lifschitz, 168–88. Cambridge, England: Cambridge University Press, 2016.
 76. Pitkin, Hanna F. *The Concept of Representation*. 1st ed. Los Angeles, United States: University of California Press, 1972.
 77. Rawls, John. *A Theory of Justice*. 2nd ed. Cambridge, Massachusetts, United States: Harvard University Press, 1999.
 78. Raz, Joseph. *The Morality of Freedom*. Oxford: Clarendon Press, 1986.
 79. Rhodes, R.A.W., Sarah A. Binder, and Bert A. Rockman, eds. *The Oxford Handbook of Political Institutions*. *Oxford Academic*. Oxford, England: Oxford University Press, 2008.
 80. Ripstein, Arthur. ‘Liberty and Equality.’ Chapter. In *Ronald Dworkin*, 82–108. Cambridge, England: Cambridge University Press, 2012.
 81. Robert, Henry M. *Robert’s Rules of Order*. *Roberts Rules*. London, England: Constitution Society, 1915.
 82. Rohrschneider, Robert, and Jacques Thomassen, eds. ‘Introduction: Political Representation in Liberal Democracies.’ Chapter. In *Oxford Handbook of Political Representation in Liberal Democracies*, 1–14. Oxford, England: Oxford University Press, 2020.
 83. Russell, Bertrand. *Freedom and Organization 1814-1914*. London, United Kingdom: George Allen & Unwin, 1934.
 84. Russell, William Fletcher. *Liberty vs. Equality*. New York, United States: The Macmillan Company, 1936.
 85. Rothschild, Emma. *Economic Sentiments: Adam Smith, Condorcet and the Enlightenment*. Cambridge, Massachusetts, 2001.
 86. Sandel, Michael J., ed. *Liberalism and Its Critics: Readings in Social & Political Theory*. New York, United States: New York University Press, 1984.
 87. Shugart, Matthew S. ‘Comparative Executive–Legislative Relations.’ Chapter. In *The Oxford Handbook of Political Institutions*, edited by Sarah A. Binder, R. A. W. Rhodes, and Bert A. Rockman, 344–65. Oxford, England: Oxford University Press, 2008.
 88. Sniderman, Paul M., Joseph F. Fletcher, Peter H. Russell, and Philip E. Tetlock. *The Clash of Rights: Liberty, Equality and Legitimacy in Pluralist Democracy*. New Haven, CT: Yale University Press, 1996.
 89. Sommerville, Johann. ‘The Social Contract (Contract of Government).’ Chapter. In *The Oxford Handbook of the History of Political Philosophy*, edited by George Klosko, 573–85. Oxford, England: Oxford University Press, 2011.
 90. Stone, Adrienne and Schauer, Frederick. ‘Introduction,’ Chapter. In *The Oxford Handbook of Freedom of Speech*, edited by Stone, Adrienne and Schauer, Frederick. Chapter 1. Oxford, England: Oxford University Press, 2021.
 91. Taylor, Charles. *A Secular Age*. 1st ed. Cambridge, Massachusetts: Harvard University Press, 2007.

92. Taylor, Charles. *The Malaise of Modernity*. Toronto, ON, Canada: House of Anansi Press, 1998.
93. Taylor, Michael. 1982. 'Equality in Anarchy.' Chapter. In *Community, Anarchy and Liberty*, 95–139. Cambridge: Cambridge University Press.
94. Taylor-Robinson, Michelle M., and Maria C. Escobar-Lemmon. 'Executive-Legislative Relations in Democratic Regimes: Managing the Legislative Process.' Chapter. In *The Oxford Handbook of Political Executives*, edited by Rudy B. Andeweg, Robert Elgie, Ludger Helms, Juliet Kaarbo, and Ferdinand Müller-Rommel, 547–65. Oxford, England: Oxford University Press, 2020.
95. The Mother. *Mother's Agenda: 13 vols.* Translated by Sri Aurobindo Ashram Translation Department. Compiled by Satprem. Pondicherry: Sri Aurobindo Ashram Publication Department, 1982.
96. Torfing, Jacob. 'Governance Networks.' Chapter. In *The Oxford Handbook of Governance*, edited by David Levi Faur, 99–112. Oxford, England: Oxford University Press, 2012. and
97. Townley, Barbara. *Reason's Neglect: Rationality and Organizing*. Oxford Academic. Oxford, England: Oxford University Press, 2008.
98. Uhr, John. 'Bicameralism.' Chapter. In *The Oxford Handbook of Political Institutions*, edited by Sarah A. Binder, R. A. W. Rhodes, and Bert A. Rockman, 474–94. Oxford, England: Oxford University Press, 2009.
99. Unger, Roberto Mangabeira. *False necessity: anti-necessitarian social theory in the service of radical democracy*. London: Verso, 2001.
100. Varma, Vishwanath Prasad. *Studies in Hindu Political Thought and its Metaphysical Foundation*. 3rd ed. Delhi: Motilal Banarsidass, 1974.
101. Wade, HWR and Forsyth, CF. *Administrative Law*. Oxford, England: Oxford University Press, 2009.
102. Waldron, Jeremy. *Law and Disagreement*. Oxford, England: Oxford University Press, 1999.
103. Waldron, Jeremy. *The Right to Private Property*. Oxford, United Kingdom: Oxford University: Clarendon Press, 1990.

Articles

1. 'Prioritising RA Decision Making.' *Auroville Today*, Issue No. 407-408, June & July 2023.
2. 'Overview: Participatory Democracy.' Oxford Reference, n.d.
3. 'The Auroville situation: a view from outside.' *Auroville Today*, Issue No. 410, September 2023.
4. Abbey, Ruth, and Charles Taylor. 'Communitarianism, Taylor-Made: An Interview with Charles Taylor.' *The Australian Quarterly* 68, no. 1 (1996): 1–10.
5. Baldiga, Katherine. *A Failure of Representative Democracy*, August 2011. https://micro.econ.kit.edu/downloads/Baldiga_ReprDemo.pdf.
6. Bertou, Eri, and Giulia Pastorella. 'Technocratic attitudes: a citizens' perspective of expert decision-making.' *West European Politics* 40, no. 2 (2017): 430-458.

7. Bickerton, Christopher, and Carlo Invernizzi Accetti. 'Populism and technocracy: opposites or complements?' *Critical Review of International Social and Political Philosophy* 20, no. 2 (2017): 186-206.
8. Bobbio, Luigi. 'Designing Effective Public Participation.' *Policy and Society* 38, no. 1 (September 23, 2018): 41–57.
9. Bobbio, Luigi. 'Designing Effective Public Participation.' *Policy and Society* 38, no. 1 (September 23, 2018): 41–57.
10. Bose, Thomas, Andreagiovanni Reina, and James AR Marshall. 'Collective decision-making.' *Current Opinion in Behavioral Sciences* 16 (2017): 30-34.
11. Bruneder, Johanna, Oguz A. Acar, Dirk Diechmann, and Tarun Sarwal. 'A New Model for Crowdsourcing Innovation.' *Harvard Business Review*, January 31, 2020.
12. Burns, R., Fast, V., Levenda, A., & Miller, B. (2021). 'Smart cities: Between worlding and provincialising.' *Urban Studies* 58(3): 461–470.
13. Carter, Ian. 'Positive and Negative Liberty.' Edited by Edward N Zalta. *Stanford Encyclopedia of Philosophy*, November 19, 2021. <https://plato.stanford.edu/entries/liberty-positive-negative/>.
14. Christiano, Thomas. 'Waldron on Law and Disagreement.' *Law and Philosophy* 19, no. 4 (July 2000): 513–43.
15. Christiano, Tom. 'Authority.' Edited by Edward N Zalta. *Stanford Encyclopedia of Philosophy*, January 11, 2012. <https://plato.stanford.edu/entries/authority/>.
16. Coffman, Katherine Baldiga. 'Representative Democracy and the Implementation of Majority-Preferred Alternatives.' *Social Choice and Welfare* 46, no. 3 (May 18, 2015): 477–94.
17. Cunningham, Paul A., and Stephen L. Wearing. 'The Politics of Consensus: An Exploration of the Cloughjordan Ecovillage, Ireland.' *Cosmopolitan Civil Societies* 5, no. 2 (2013): 1-28.
18. Dameri, R. P., & Benevolo, C. (2016). 'Governing Smart Cities: An Empirical Analysis.' *Social Science Computer Review* 34(6): 693–707.
19. David-Barrett, Tamas, and Robin I. M. Dunbar. 'Cooperation, Behavioural Synchrony and Status in Social Networks.' *Journal of Theoretical Biology* 308 (2012): 88–95.
20. De Angelis, Gabriele. 'Habermas, Democracy and the Public Sphere: Theory and Practice.' *European Journal of Social Theory* 24, no. 4 (August 20, 2021): 437–47.
21. Deller, Rose. 'Book Review: Against Elections: The Case for Democracy by David Van Reybrouck.' *Web log. LSE Review of Books* (blog), October 20, 2016. <https://blogs.lse.ac.uk/lsereviewofbooks/2016/10/20/book-review-against-elections-the-case-for-democracy-by-david-van-reybrouck/>.
22. Dick-Sago, Christopher. 'Decentralization for Improving the Provision of Public Services in Developing Countries: A Critical Review.' Edited by Jorge Miguel Lopo Gonçalves Andraz. *Cogent Economics & Finance*, 8, no. 1 (August 10, 2020).
23. Douglass, Robin. 'Rousseau's Critique of Representative Sovereignty: Principled or Pragmatic?' *American Journal of Political Science* 57, no. 3 (March 12, 2013): 735–47.
24. Dyer, John R.G, Anders Johansson, Dirk Helbing, Iain D Couzin, and Jens Krause. 'Leadership, Consensus Decision Making and Collective Behaviour in Gumans.'

- Philosophical Transactions of the Royal Society B: Biological Sciences* 364, no. 1518 (December 12, 2008).
25. Eliassi-Rad, Tina, Henry Farrell, David Garcia, Stephan Lewandowsky, Patricia Palacios, Don Ross, Didier Sornette, Karim Thébault, and Karoline Wiesner. ‘What Science Can Do for Democracy: A Complexity Science Approach.’ *Humanities and Social Sciences Communications* 7, no. 30 (July 10, 2020).
 26. Escobar, Oliver. ‘Pluralism and Democratic Participation: What Kind of Citizen are Citizens Invited to be?’, *Contemporary Pragmatism* 14, 4 (2017): 416-438.
 27. Ezrow, Lawrence, Michele Fenzl, and Timothy Hellwig. ‘Bicameralism and Policy Responsiveness to Public Opinion.’ *American Journal of Political Science*, February 23, 2023, 1–17.
 28. Fabienne, Peter. ‘Political Legitimacy.’ Edited by Edward N Zalta. Stanford Encyclopedia of Philosophy, April 24, 2017. <https://plato.stanford.edu/entries/legitimacy/>.
 29. Farris, Jeremy D., and William A. Edmundson. ‘Book Review: Political Political Theory: Essays on Institutions. By Jeremy Waldron.’ *Constitutional Commentary* 32, (2017): 493–511.
 30. Fiala, Andrew. ‘Anarchism.’ Edited by Edward N Zalta. Stanford Encyclopedia of Philosophy, October 26, 2021. <https://plato.stanford.edu/entries/anarchism/>.
 31. Fisk, David. ‘Bicameralism in Stable Democracies.’ *Political Science*, November 29, 2018.
 32. Fontanari, José F., and Rodrigues, Francisco. ‘Influence of Network Topology on Cooperative Problem-Solving Systems.’ *Theory in Biosciences* 135 (September 2016): 101–10.
 33. Foster, Sheila R., and Christian Iaione. ‘The City as a Commons.’ *Yale Law & Policy Review* 34, no. 2 (2016): 281–349.
 34. Frances, Bryan, and Jonathan Matheson. ‘Disagreement.’ Edited by Edward N. Zalta. Stanford Encyclopedia of Philosophy, February 23, 2018. <https://plato.stanford.edu/entries/disagreement/>.
 35. Geertman, Stan, and John Stillwell. “Interactive Support Systems for Participatory Planning.” Chapter. In *Planning Support Systems in Practice*, edited by Stan Geertman and John Stillwell, 25–44. Advances in Spatial Science. Berlin, Germany: Springer, 2003.
 36. Gerber, Alan S., Gregory A. Huber, David Doherty, and Conor M. Dowling. ‘Disagreement and the Avoidance of Political Discussion: Aggregate Relationships and Differences across Personality Traits.’ *American Journal of Political Science* 56, no. 4 (2012): 849–74.
 37. Giannetti, Daniela, Andrea Pedrazzani, and Luca Pinto. 2020. ‘Bicameralism and Government Formation: Does Bicameral Incongruence Affect Bargaining Delays?’ *European Political Science Review* 12 (4). Cambridge University Press: 469–84.
 38. Gibbs, D., Krueger, R., & MacLeod, G. (2013). ‘Grappling with Smart City Politics in an Era of Market Triumphalism.’ *Urban Studies* 50(11): 2151–2157.

39. Gilley, Bruce. 'Technocracy and Democracy as Spheres of Justice in Public Policy.' *Policy Sciences* 50 (2017): 9-22.
40. Gomes, PF, Reia, SM, Rodrigues, FA, Fontanari, JF. 'Mobility helps Problem-Solving Systems to Avoid Groupthink.' *Physical Review E* 99, no. 3-1 (March 2019): 032301.
41. Gutmann, Amy. 'Review: Communitarian Critics of Liberalism.' *Philosophy & Public Affairs* 14, no. 3 (1985): 308–22.
42. Hawkins, C. (2014). 'Competing Interests and the Political Market for Smart Growth Policy.' *Urban Studies* 51(12): 2503–2522.
43. Hayat, P. (2016). 'Smart Cities: A Global Perspective.' *India Quarterly* 72(2): 177–191.
44. Hoelscher, K. (2016). 'The Evolution of the Smart Cities Agenda in India.' *International Area Studies Review* 19(1): 28–44.
45. Ingham, Sean. 2022. 'Representative Democracy and Social Equality.' *American Political Science Review* 116 (2). Cambridge University Press: 689–701.
46. Jacobs, Struan. 'John Stuart Mill on the Tyranny of the Majority.' *Australian Journal of Political Science* 28, no. 2 (1993): 306–21.
47. Kaim, Marcin. 'Rethinking Modes of Political Participation: The Conventional, Unconventional, and Alternative.' *Democratic Theory* 8, no. 1 (June 2021): 50–70.
48. Kapoor, R. (2007). 'Auroville: A Spiritual-social Experiment in Human Unity and Evolution.' *Futures* 39(5): 632-643.
49. Keil, R. (2020). 'An Urban Political Ecology for a World of Cities.' *Urban Studies* 57(11): 2357–2370.
50. King, Andrew J., and G. Cowlshaw. 'Leaders, Followers, and Group decision-making.' *Communicative & Integrative Biology* 2, no. 2 (2009): 147-150.
51. Krishnaswamy, Sudhir. 'Is the Indian Constitution Liberal?' Essay. In *How Liberal Is India?*, edited by Ronald Meinardus, 51–65. New Delhi, India: Academic Foundation, 2019.
52. Kundnani, Hans. 'Beyond Representative Democracy?' Section. In *The Future of Democracy in Europe: Technology and the Evolution of Representation*, 30–36. London, England: Chatham House International Affairs Think Tank, 2020.
53. Landmore, Helene E. 'Why the Many Are Smarter than the Few and Why It Matters.' *Journal of Public Deliberation* 8, no. 1 (April 16, 2012).
54. Landmore, Hélène. 'Deliberative Democracy as Open, Not (Just) Representative Democracy.' *Daedalus* 146, no. 3 (2017): 51–63.
55. Landwehr, Claudia. 'Democratic and Technocratic Policy Deliberation.' *Critical Policy Studies* 3, no. 3–4 (April 26, 2010): 434–39.
56. Lange, Stella. 'Plato and Democracy.' *The Classical Journal* 34, no. 8 (1939): 480–86.
57. Levy, Neil. 'The Surprising Truth About Disagreement.' *Acta Analytica* 36 (June 8, 2020): 137–57.
58. Liu, Helen K. 'Crowdsourcing Government: Lessons from Multiple Disciplines.' *Public Administration Review* 77, no. 5 (July 13, 2017): 656–67.
59. Llewellyn, Karl N. 'Remarks on the Theory of Appellate Decision and the Rules or Canons about How Statutes Are to Be Construed.' *Vanderbilt Law Review* 3 (1950): 395.

60. Marmor, Andrei. 'On the Limits of Rights.' *Law and Philosophy* 16, no. 1 (1997): 1–18.
61. Marvin, Simon, and Andrés Luque Ayala. 'Urban Operating Systems: Diagramming the City.' *International Journal of Urban and Regional Research* 41, no. 1 (January 2017): 84–103.
62. Mason, Winter A., Andy Jones, and Robert L. Goldstone. 'Propagation of Innovations in Networked Groups.' *Journal of Experimental Psychology: General* 137, no. 3 (August 2008): 422–33.
63. Miklian, J., & Hoelscher, K. (2017). 'Smart Cities, Mobile Technologies and Social Cohesion in India.' *Indian Journal of Human Development* 11(1): 1–16.
64. Miller, Joshua P. 'Caring to Disagree: Democratic Disagreement as Civic Care.' *Polity* 44, no. 3 (2012): 400–425.
65. Moore, Alfred. 'Democratic Reason: Politics, Collective Intelligence and the Rule of the Many.' *Contemporary Political Theory* 13 (March 20, 2014): e12–15.
66. Munshi, Indra. 'On the Margins of Sociology: An Appreciation of Patrick Geddes's Work in India.' *Sociological Bulletin: Special Issue on The Bombay School of Sociology: The Stalwarts and Their Legacies (May-August 2013)* 62, no. 2 (2013): 217–38.
67. Papenfuß, Ulf, and Christian A. Schmidt. 'Understanding Self-Regulation for Political Control and Policymaking: Effects of Governance Mechanisms on Accountability.' *Governance* 34, no. 4 (October 23, 2020): 1115–41.
68. Parvin, Phil. 'Democracy without Participation: A New Politics for a Disengaged Era.' *Res Publica* 24 (February 2018): 31–52.
69. Picon, Antoine. 'Urban Infrastructure, Imagination and Politics: From the Networked Metropolis to the Smart City.' *International Journal of Urban and Regional Research* 42, no. 2 (March 2018): 263–75.
70. Rawls, John. 'The Sense of Justice.' *The Philosophical Review* 72, no. 3 (1963): 281–305.
71. Rosenberg, Jonas Hultin. 'Democracy, Respect for Judgement and Disagreement on Democratic Inclusion.' *Critical Review of International Social and Political Philosophy* 26, no. 4 (June 1, 2020): 506–27.
72. Salter, Frank Kemp. 'Review: Human Nature and Politics by Albert Somit, Joseph Losco.' *Politics and the Life Sciences* 15, no. 2 (September 1996): 361–63.
73. Shapiro, Ian. 'Collusion in Restraint of Democracy: Against Political Deliberation.' *Daedalus* 146, no. 3 (2017): 77–84.
74. Shinn, Larry D. 'Auroville: Visionary Images and Social Consequences in a South Indian Utopian Community.' *Religious Studies* 20, no. 2 (June 1984): 239–53.
75. Smith, Amanda. 'The Transition Town Network: A Review of Current Evolutions and Renaissance.' *Social Movement Studies* 10, no. 1 (March 10, 2011): 99–105.
76. Spafford, Duff. 'Mill's Majority Principle.' *Canadian Journal of Political Science* 18, no. 3 (September 1985): 599–608.
77. Sudhipongpracha, Tatchalerm, and Achakorn Wongpredee. 'Decentralizing Decentralized Governance: Community Empowerment and Coproduction of Municipal

- Public Works in Northeast Thailand.’ *Community Development Journal* 51, no. 2 (April 26, 2016): 302–19.
78. Sunstein, Cass R. ‘From Technocrat to Democrat.’ *Harvard Law Review* 128, no. 1 (2014): 488–97.
 79. Sunstein, Cass R. ‘Incompletely Theorized Agreements.’ *Harvard Law Review* 108, no. 7 (1995): 1733–72.
 80. Swapan, Mohammad Shahidul Hasan. ‘Who Participates and Who Doesn’t? Adapting Community Participation Model for Developing Countries.’ *Cities* 53 (April 2016): 70–77.
 81. Taylor, Charles. ‘Modes of Civil Society.’ *Public Culture* 3, no. 1 (1990): 95–118.
 82. The Mother. ‘A Dream Envisioning an Ideal Society.’ Auroville The City of Dawn. <https://auroville.org/page/a-dream>.
 83. The Mother. ‘To Be a True Aurovilian Embodying a Greater Consciousness.’ Auroville The City of Dawn. June 13, 1970. <https://auroville.org/page/a-true-aurovilian>.
 84. Tobback, Claire. ‘Citizens’ Assemblies and Panels on the Rise: Catching the Deliberative Wave.’ citizenlab, November 30, 2021.
 85. Valentini, Laura. ‘Justice, Disagreement and Democracy.’ *British Journal of Political Science* 43, no. 1 (July 19, 2012): 177–99.
 86. Van Bussel, Lenny G.J., Nina De Haan, Roy P. Remme, Marjolein E. Lof, and Rudolf De Groot. ‘Community-Based Governance: Implications for Ecosystem Service Supply in Berg En Dal, the Netherlands.’ *Ecological Indicators*, 106510, 117 (October 2020).
 87. Van Gossum, Peter, Bas Arts, and Kris Verheyen. ‘From ‘Smart Regulation’ to ‘Regulatory Arrangements.’’ *Policy Sciences* 43 (February 25, 2010): 245–61.
 88. Venkitaraman, Abhishek Koduvayur, and Neelakshi Joshi. ‘A Critical Examination of a Community-Led Ecovillage Initiative: A Case of Auroville, India.’ *Climate Action* 1, no. 15 (July 8, 2022).
 89. Verli, Dorina. ‘Reforming Democracy: Constitutional Crisis and Rousseau’s Advice to Geneva.’ *The Review of Politics* 80, no. 3 (June 20, 2018): 415–38.
 90. Vincent-Jones, Peter. ‘Contractual Governance: Institutional and Organizational Analysis.’ *Oxford Journal of Legal Studies* 20, no. 3 (September 1, 2000): 317–51.
 91. Varma, Vishwanath Prasad. ‘Sri Aurobindo’s Philosophy of Political Vedantism.’ *The Indian Journal of Political Science* 18, no. 1 (1957): 24–35
 92. Waldron, Jeremy. ‘Separation of Powers in Thought and Practice.’ *Boston College Law Review* 54, no. 2 (2013): 433–468.
 93. Waldron, Jeremy. ‘Political Political Theory: An Inaugural Lecture.’ *Journal of Political Philosophy* 21, no. 1 (December 6, 2012): 1–23.
 94. Weir, Kristen. ‘Politics Is Personal.’ *Monitor on Psychology* 50, no. 10 (November 1, 2019).
 95. West, B. J., G. F. Massari, G. Culbreth, R. Failla, M. Bologna, R. I. Dunbar, and P. Grigolini. ‘Relating Size and Functionality in Human Social Networks through Complexity.’ Edited by Douglas S. Massey. *Proceedings of the National Academy of Sciences* 117, no. 31 (July 20, 2020): 18355–58.

96. Wisdom, Thomas N. and Robert L. Goldstone. 'Innovation, imitation, and problem-solving in a networked group.' *Nonlinear Dynamics Psychol. Life Sci* 15, no. 2 (April 2011): 229-52.
97. Wisdom, Thomas N., Xianfeng Song, and Robert L. Goldstone. 'Social Learning Strategies in Networked Groups.' *Cognitive Science* 37, no. 8 (2013): 1383–1425.
98. Witesman, Eva M. 'Centralization and Decentralization: Compatible Governance Concepts and Practices.' *Oxford Research Encyclopaedia of Politics*, October 27, 2020.
99. Zimmerman, Joseph F. 1994. 'Alternative Voting Systems for Representative Democracy.' *PS: Political Science & Politics* 27 (4). Cambridge University Press: 674–77.
100. Delli Carpini, Michael X., Fay Lomax Cook, and Lawrence R. Jacobs. "Public Deliberation, Discursive Participation, and Citizen Engagement: A Review of the Empirical Literature." *Annual Review of Political Science* 7 (June 15, 2004): 315–44.
101. Feldman, Martha S., and Anne M. Khademian. "The Role of the Public Manager in Inclusion: Creating Communities of Participation." *Governance* 20, no. 2 (April 2007): 305–24.
102. Fischer, Frank. "Participatory Governance as Deliberative Empowerment: The Cultural Politics of Discursive Space." *The American Review of Public Administration* 36, no. 1 (March 2006): 19–40.
103. Fowler, James H., and Cindy D. Kam. "Beyond the Self: Social Identity, Altruism and Political Participation." *The Journal of Politics* 69, no. 3 (August 2007): 813–27.
104. Fung, Archon, and Erik Olin Wright. "Deepening Democracy: Innovations in Empowered Participatory Governance." *Politics & Society* 29, no. 1 (March 2001): 5–41.
105. Gaventa, John. "Towards Participatory Local Governance: Six Propositions for Discussion." *Currents* 28 (August 2002): 29–35.
106. Hicks, Douglas A. "Self-Interest, Deprivation, and Agency: Expanding the Capabilities Approach." *Journal of the Society of Christian Ethics* 25, no. 1 (2005): 147–67.
107. Khwaja, Asim Ijaz. "Is Increasing Community Participation Always a Good Thing?" *Journal of the European Economic Association* 2, no. 2/3 (2004): 427–36.
108. Ojha, Hemant R. "Techno-Bureaucratic Doxa and Challenges for Deliberative Governance: The Case of Community Forestry Policy and Practice in Nepal." *Policy and Society* 25, no. 2 (January 1, 2006): 131–75.
109. Osmani, S. R. "Participatory Governance: An Overview of Issues and Evidence." Essay. In *Participatory Governance and the Millennium Development Goals*, 1–45. New York, United States: United Nations Department for Economic and Social Affairs, 2007.
110. Papadopoulos, Yannis, and Philippe Warin. "Are Innovative, Participatory and Deliberative Procedures in Policy Making Democratic and Effective?" *European Journal of Political Research* 46, no. 4 (April 25, 2007): 445–72.
111. Platteau, Jean-Philippe. "Pitfalls of participatory development." Essay. In *Participatory Governance and the Millennium Development Goals*, 127–62. New

York, United States: United Nations Department for Economic and Social Affairs, 2007.

112. Rowe, Gene, and Lynn J. Frewer. "Evaluating Public-Participation Exercises: A Research Agenda." *Science, Technology, & Human Values* 29, no. 4 (2004): 512–57.
113. Baaren, Hans Van. 'On Authority.' AWARE Auroville, May 26, 2023. <https://awareauroville.com/on-authority/>.
114. 'Way Forward from Auroville Retreat.' Auroville Radio, October 7, 2015. <https://www.aurovillerradio.org/wayforward-from-auroville-retreat/>.

Reports

1. Bartlett, Jamie, and Nathaniel Tkacz. Rep. *Governance by Dashboard: A Policy Paper*. Demos, March 2017.
2. Columberg, Dumeni. Rep. *Report on Instruments of Citizen Participation in Representative Democracy*. Group of the European People's Party, Parliamentary Assembly of the Council of Europe, March 25, 1997.
3. Goot, Murray. Rep. *Distrustful, Disenchanted and Disengaged? Polled Opinion on Politics, Politicians and the Parties: An Historical Perspective (Papers on Parliament, No. 38)*, April 2002.
4. *Minutes of the 26th Meeting of Auroville's International Advisory Council (1st- 3rd August, 2014)*. Auroville, India: Auroville Foundation, 2014. Auroville Archives, uncatalogued.
5. Parliament of Australia, and Simon Tormey, *The Contemporary Crisis of Representative Democracy*. Papers on Parliament, no. 66. 2016.

Correspondence and Administrative Documents

1. Letter to Secretary, Auroville Foundation. *Residents Assembly Decisions*. Auroville: Working Committee of the Residents' Assembly, 1999 (on file).
2. *Minutes of the 57th Governing Board Meeting held on 2nd November 2021*. Auroville Foundation, 2021. <http://aurovillefoundation.org.in/wp-content/uploads/2023/03/57th-MoM-Website-File-20-03-2023.pdf>.
3. *Minutes of the 58th Governing Board Meeting (hybrid mode) held on 18th January 2022*. Auroville Foundation, 2022. <http://aurovillefoundation.org.in/wp-content/uploads/2023/03/58th-MoM-Website-File-20-03-2023.pdf>.
4. *Minutes of the 59th Governing Board Meeting (hybrid mode) held on 12th April 2022*. Auroville Foundation, 2022. <http://aurovillefoundation.org.in/wp-content/uploads/2023/03/59th-MoM-Website-File-21-03-2023-revised.pdf>.
5. *Minutes of the 60th Governing Board Meeting (hybrid mode) held on 12th July 2022*. Auroville Foundation, 2022. <http://aurovillefoundation.org.in/wp-content/uploads/2023/03/60th-MoM-Website-File-21-03-2023-revised.pdf>.
6. *Minutes of the 61st Governing Board Meeting (hybrid mode) held on 08th November 2022*. Auroville Foundation, 2022. <http://aurovillefoundation.org.in/wp-content/uploads/2023/03/61st-MoM-Website-File-10-03-2023.pdf>.
7. *Minutes of the Twentieth Meeting of the Governing Board*. Auroville Foundation, 1999. Auroville Archives, uncatalogued.

8. *Minutes Residents' Assembly Meeting on July 28th, 1999.* Auroville News, 1999 (on file).
9. *Minutes of the 20th Governing Board Meeting held on 14th August 1999.* Auroville Foundation, 1999 (on file).

Legislative Material

1. Auroville Universal Township Masterplan, Perspective: 2025. 'The Gazette of India.' Government of India Press. June 11, 2011 (on file).
2. Bernard, Alain. 'The French Pavilion Talks: Auroville.' Genesis of the Auroville Foundation Act. Lecture, French Pavilion, Auroville, January 23, 2010. Auroville Press Publishers, September 2017.
3. Executive Committee Of Vaish Degree College v. Lakshmi Narain And Ors, (1976) 2 SCC 58.
4. Government of India, Auroville (Emergency Provisions) Act, Parliament of India, No. 59, New Delhi, 1980.
5. Government of India, Auroville (Emergency Provisions) Amendment Bill, Rajya Sabha, No. 51, New Delhi, 1985.
6. Government of India, Auroville Foundation Act, Parliament of India, No. 54, New Delhi, 1988.
7. Government of India, Seeking Disapproval the Kalakshetra Foundation Ordinance Promulgated by President on 29th September, 1993, II. THE KALAKSHETRA FOUNDATION BILL, 1993, Rajya Sabha, New Delhi, 1993.
8. Government of India, Statutory Resolution Re: Disapproval of Auroville (Emergency Provisions) Ordinance, 1980, and Auroville (Emergency Provisions) Bill, Lok Sabha No.07, New Delhi, 1980.
9. International Advisory Council. Letter to Working Committee (on file). Auroville: India, April 2015.
10. Mandate of the Auroville Council (as approved by RA Meeting of December 20, 2004) § (2004).
11. *Participatory Working Groups & The Selection Process of Their Members (Amended Version)*, Rep. April 2022.
12. Auroville Foundation, Code of Conduct for all Trusts and Units of the Auroville Foundation (2017) (on file).
13. Sorabjee. 'Opinion for Querist.' Working Committee of Residents' Assembly, Auroville Foundation, 8th January 2008 (on file).
14. Sukhdev Singh and Ors. v. Bhagat Ram and Ors., AIR 1975 SC 1331.
15. Vemareddy Kumaraswamy Reddy & Anr. v. State Of Andhra Pradesh, AIR 2006 SC 3517.

Founding Documents

1. Mother, The. 'A Dream.' 1954. <https://auroville.org/page/a-dream> .
2. Mother, The. 'The Auroville Charter.' February 28, 1968. <https://auroville.org/page/auroville-charter>.

3. Mother, The. 'To Be A True Aurovilian.' June 13, 1970. <https://auroville.org/page/a-true-aurovilian> .

B. Planning, Land and Housing

Books

1. Arpi, Claude, Christine Devin, and Alain Bernard, eds. *Auroville Smart City of Another Kind*. Auroville: Auroville Press Publishers, 2018.
2. Bibri, Simon. *Advances in the Leading Paradigms of Urbanism and their Amalgamation: Compact Cities, Eco-Cities, and Data-Driven Smart Cities*. Switzerland: Springer, 2020.
3. Brenner, Neil. *New Urban Spaces: Urban Theory and the Scale Question*. Oxford Academic. Oxford, England: Oxford University Press, 2019.
4. Butler, Judith, Jürgen Habermas, Charles Taylor, and Cornel West. *The Power of Religion in the Public Sphere*. Edited by Eduardo Mendieta and Jonathan VanAntwerpen. New York: Columbia University Press, 2011.
5. Dagan, Hanoch. *Property: Values and Institutions*. Oxford Academic. Oxford, England: Oxford University Press, 2011.
6. Dameri, Renata Paola. “Urban Smart Dashboard. Measuring Smart City Performance.” Chapter. In *Smart City Implementation: Creating Economic and Public Value in Innovative Urban Systems*, 67–84. Cham, Germany: Springer, 2016.
7. Desai, Madhavi. *Women Architects and Modernism in India Narratives and Contemporary Practices*. 1st ed. New Delhi, India: Routledge, 2019.
8. Fang, Chuanglin, and Danlin Yu. *China’s new urbanization: Developmental paths, blueprints and patterns*. Berlin, Germany: Springer, 2016.
9. Fishkin, James S. *When the People Speak: Deliberative Democracy and Public Consultation*. Oxford Academic. Oxford, England: Oxford University Press, 2011.
10. Fragkias, Michail, Burak Güneralp, Karen C. Seto, and Julie Goodness. ‘A Synthesis of Global Urbanization Projections.’ Chapter. In *Urbanization, Biodiversity and Ecosystem Services: Challenges and Opportunities: A Global Assessment*, edited by Thomas Elmqvist, Michail Fragkias, Julie Goodness, Burak Güneralp, Peter Marcotullio, Robert Ian McDonald, Sue Parnell, et al., 409–35. Berlin, Germany: Springer Dordrecht, 2013.
11. Gastil, John, and Peter Levine, eds. *The Deliberative Democracy Handbook: Strategies for Effective Civic Engagement in the Twenty-First Century*. San Francisco, United States: Jossey-Bass, 2011.
12. Geddes, Patrick. ‘The Evolution of Cities.’ Essay. In *Early Urban Planning V4*, edited by Richard LeGates and Frederic Stout, 1st ed. London, England: Routledge, 2021.
13. Habermas, Jürgen. *The structural transformation of the public sphere: An enquiry into a category of Bourgeois Society*. Cambridge: MIT Press, 1991.
14. Halliday, Daniel. *Inheritance of Wealth: Justice, Equality, and the Right to Bequeath*. Oxford Academic. Oxford, England: Oxford University Press, 2018.
15. Hirschkop, Ken. “The Public Square as Public Sphere.” Chapter. In *Mikhail Bakhtin: An Aesthetic for Democracy*, 249–71. Oxford, England: Oxford University Press, 1999.
16. Hopper, Edward, and Gail Levin. *The paintings of Edward Hopper*. New York, United States: W. W. Norton & Company, 2001.

17. Joss, Simon. "Evaluating Consensus Conferences: Necessity or Luxury?" Chapter. In *Public Participation in Science: The Role of Consensus Conferences in Europe*, edited by Simon Joss and John Durant, 89–108. London, England: Science Museum (with the support of the European Commission Directorate General XII), 1995.
18. Low, Setha. *Why Public Space Matters*. Oxford Academic. Oxford, England: Oxford University Press, 2022. <https://doi.org/10.1093/oso/9780197543733.001.0001>.
19. MacDonald, John, Charles Branas, and Robert Stokes. *Changing Places: The Science and Art of New Urban Planning*. Oxford Academic. Princeton, United States: Princeton University Press, 2019.
20. Malena, Carmen, ed. *From Political Won't to Political Will: Building Support for Participatory Governance*. Colorado, United States: Kumarian Press, 2009.
21. Miles, Malcolm. *Urban Utopias: The Built and Social Architectures of Alternative Settlements*. Chippenham, England: Routledge, 2007.
22. Morris, Raymond N. *Urban sociology*. London, England: Routledge, 2013.
23. *OECD Regions and Cities at a Glance 2020*. OECD iLibrary. Paris: OECD Publishing, 2020 [OECDa, 2020].
24. OECD, European Commission. *Cities in the World: A New Perspective on Urbanisation*. OECD iLibrary. Paris: OECD Urban Studies, OECD Publishing, 2020 [OECDb, 2020].
25. Smith, Andrew Hudson, Duncan Wilson, Steven Gray, and Oliver Dawkins. 'Urban IoT: Advances, Challenges, and Opportunities for Mass Data Collection, Analysis, and Visualization.' Essay. In *Urban Informatics*, edited by Wenzhong Shi, Michael F. Goodchild, Michael Batty, Mei Po Kwan, and Anshu Zhang, 701–19. The Urban Book Series. Springer, Singapore, 2021.
26. Soja, Edward W. *Seeking Spatial Justice*. Minneapolis: University of Minnesota Press, 2010.
27. Srinivasan, Nithya, and Kiran Venkatesh. *+91 RESIDENCES - Contemporary Indian Houses*. 2nd ed. InCITE, 2015.
28. Woiwode, Christophe, and Lalit Kishor Bhatti. 'Enabling Transformative Urban Development for Integral Sustainability: A Case for Tapping the Potential of Sri Aurobindo's Philosophy in Planning Practice and Theory.' Chapter. In *Sustainability and the Humanities*, edited by Walter Leal Filho and Adriana Consorte McCrea, 35–55. Cham, Switzerland: Springer, 2018.

Articles

1. 'Auroville Has to Implement the Master Plan, Says L-G.' The Hindu, May 28, 2022. <https://www.thehindu.com/news/cities/puducherry/auroville-has-to-implement-the-master-plan/article65470827.ece>.
2. 'Citadines.' Auroville: the City of Dawn. <https://auroville.org/page/citadines>.
3. 'L'avenir d'Auroville / Town Development Council (TDC) September 2015 Report.' *Auroville News & Notes (No. 617)*, 2023.
4. 'Studies and Research.' Auroville Center for Urban Research (ACUR). Accessed 2023. <https://www.auroville.info/ACUR/templates/research.htm>.
5. 'Sunship.' Integral Architecture, 2017. <https://www.integralarchitecture.org/sunship>.

6. "Mobility." Auroville Wiki. <https://wiki.auroville.org.in/w/index.php?title=Mobility>.
7. Ajani, Varun. 'Urban Village: Architect Anupama Kundoo's Community Housing Project Creativity in Auroville.' *Indian Architect & Builder* 18, no. 11 (July 2005).
8. Alan. 'Humanscapes.' *Auroville Today*, Issue No. 340, November 2017.
9. Alan. 'The Next Step in Auroville's Development?' *Auroville Today*, September 2010.
10. Almihat, Mohamed G. Moh, M. T. E. Kahn, Khaled Aboalez, and Ali M. Almaktoof. 'Energy and Sustainable Development in Smart Cities: An Overview.' *Smart Cities* 5, no. 4 (2022): 1389-1408.
11. Anastasiu, Bianca. 'The Pivotal Role of Public Spaces in Successful Urban Design.' Chapman Taylor, July 21, 2021. <https://www.chapmantaylor.com/insights/the-pivotal-role-of-public-spaces-in-successful-urban-design>.
12. Auroville Earth Institute. <http://www.earth-auroville.com/>.
13. Ayer, Suhasini. 'Humanscapes.' Auroville Design Consultants. <https://www.aurovilledesign.com/pdfs/humanscapes/>.
14. Balk, Deborah, Mark R. Montgomery, Hasim Engin, Natalie Lin, Elizabeth Major, and Bryan Jones. 2019. 'Urbanization in India: Population and Urban Classification Grids for 2011' *Data* 4, no. 1: 35.
15. Barns, Sarah. "Smart Cities and Urban Data Platforms: Designing Interfaces for Smart Governance." *City, Culture and Society* 12 (March 2018): 5–12.
16. Bertolini, Luca. "The next 30 Years: Planning Cities beyond Mobility?" *European Planning Studies* 31, no. 11 (May 31, 2023): 2354–67.
17. Bibri, Simon, Krogstie, John, and, Kärholm, Mattias. "Compact city planning and development: Emerging practices and strategies for achieving the goals of sustainability." *Developments in the Built Environment*, 4 (2020).
18. Björkman, Lisa, and Andrew Harris. 'Engineering Cities: Mediating Materialities, Infrastructural Imaginaries and Shifting Regimes of Urban Expertise.' *International Journal of Urban and Regional Research* 42, no. 2 (March 2018): 244–62.
19. Brennecke, Tom. "On The Use Of AI And Other Digital Tools In Participatory Urban Planning." *Parametric Architecture*, July 23, 2023.
20. Brenner, Neil. 'Theses on Urbanization.' *Public Culture*, 69, 25, no. 1 (January 1, 2013): 85–114.
21. Brody, Samuel. 'The Characteristics, Causes, and Consequences of Sprawling Development Patterns in the United States.' *Nature Education Knowledge* 4, no. 5 (2013).
22. BTTF. 'For Architects & Engineers.' Auroville City Planning, March 18, 2019.
23. BTTF. 'Urbanism of Auroville by Mario Heymann: Urbanism and Architecture of Auroville Mario Heyman, UNESCO Conference 1966.' Auroville City Planning, March 18, 2019. <https://www.auroville-citytheearthneeds.org/urbanism-of-auroville-by-mario-heyman/>.
24. Burns, R., & Andrucki, M. (2021). 'Smart cities: Who cares?' *Environment and Planning A: Economy and Space* 53(1): 12–30.
25. Calhoun, Craig. 'Civil Society and the Public Sphere.' *Public Culture* 5, no. 2 (1993): 267–80.

26. Cesario, Eugenio, Paschal I. Uchubilo, Andrea Vinci, and Xiaotian Zhu. 'Multi-density urban hotspots detection in smart cities: A data-driven approach and experiments.' *Pervasive and Mobile Computing* 86 (2022): 101687.
27. Cheshmehzangi, Ali, and Chris Butters. 'Sustainable Living and Urban Density: The Choices Are Wide Open.' *Energy Procedia* 88 (June 2016): 63–70.
28. Cicionesi, Piero, and Gloria Cicionesi. 'The Context Auroville-Unfolding of a Vision.' *issuu*. Accessed July 14, 2023. https://issuu.com/mapin/docs/piero_and_gloria_cicionesi/s/10651312.
29. Coelho, K., & Sood, A. (2022). 'Urban studies in India across the millennial turn: Histories and futures.' *Urban Studies* 59(13): 2613–2637.
30. Daffara, Patrizia. 'Rethinking Tomorrow's Cities: Emerging issues on city foresight.' *Futures* 43 (2011): 680–689.
31. Dharan, Lakshay. 'Landing Auroville.' AWARE Auroville, June 16, 2023. <https://awareauroville.com/landing-auroville/>.
32. Dikeç, Mustafa. 'Justice and the Spatial Imagination.' *Environment and Planning A: Economy and Space* 33, no. 10 (2001): 1785–1805.
33. Duivenvoorden, Eva, Thomas Hartmann, Marlies Brinkhuijsen, and Ton Hesselmans. 'Managing public space—A blind spot of urban planning and design.' *Cities* 109 (2021): 103–32.
34. Ewing, Reid, and Susan Handy. 'Measuring the Unmeasurable: Urban Design Qualities Related to Walkability.' *Journal of Urban Design* 14, no. 1 (February 13, 2009): 65–84.
35. Farmanbar, Mina, and Chunming Rong. "Triangulum City Dashboard: An Interactive Data Analytic Platform for Visualizing Smart City Performance." *Processes* 8, no. 2 (February 24, 2020): 1–22.
36. Gandhi, S., & Phatak, V. K. (2016). 'Land-based Financing in Metropolitan Cities in India: The Case of Hyderabad and Mumbai.' *Urbanisation* 1(1): 31–52.
37. Güneralp, Burak, Yuyu Zhou, Diana Üрге-Vorsatz, Mukesh Gupta, Sha Yu, Pralit L. Patel, Michail Fragkias, Xiaoma Li, and Karen C. Seto. 'Global Scenarios of Urban Density and Its Impacts on Building Energy Use through 2050.' Edited by Jay S. Golden. *Proceedings of the National Academy of Sciences* 114, no. 34 (January 9, 2017): 8945–50.
38. Güneralp, Burak, Yuyu Zhou, Diana Üрге-Vorsatz, Mukesh Gupta, Sha Yu, Pralit L. Patel, Michail Fragkias, Xiaoma Li, and Karen C. Seto. 'Global Scenarios of Urban Density and Its Impacts on Building Energy Use through 2050.' Edited by Jay S. Golden. *Proceedings of the National Academy of Sciences (PNAS)* 114, no. 34 (January 9, 2017): 8945–50.
39. Habermas, Jürgen. 'Public space and political public sphere—the biographical roots of two motifs in my thought.' *The Journal of Philosophy of Disability* 1 (2021): 105–115.
40. Hakimov, Rustamdjan, and Dorothea Kübler. Working paper. *Experiments on Matching Markets: A Survey (WZB Discussion Paper, No. SP II 2019-205)*. WZB Berlin Social Science Center, April 2019.

41. Haklay, Muki, Piotr Jankowski, and Zbigniew Zwoliński. "Selected Modern Methods and Tools for Public Participation in Urban Planning – A Review." *Quaestiones Geographicae* 37, no. 3 (August 20, 2018): 127–49.
42. Hasan, Arif. 'Can urban density be made to work for everyone? Exploring options for Karachi's low-and lower-middle-class settlements.' *Environment and Urbanization* 22, no. 1 (2010): 267-268.
43. Head, Peter. 'Implementing the Global Goals in City Regions.' *Urbanisation* 1, no. 1 (June 2, 2016): 19–30.
44. Holland, Oscar. 'Singapore Is Building a 42,000-Home Eco 'smart' City.' CNN, February 1, 2021. <https://edition.cnn.com/style/article/singapore-tengah-eco-town/index.html>.
45. Huizenga, Sabrina Rahmawan, and Dara Ivanova. 'The Urban Lab: Imaginative Work in the City.' *International Journal of Urban and Regional Research* 46, no. 4 (July 22, 2022): 542–57.
46. Inayatullah, Sohail. 'City Futures in Transformation: Emerging issues and case studies.' *Futures* 43 (2011): 654–661.
47. Jazeel, Tariq. 'In the Shadow of 'The City' yet to Come: Auroville, Developmentalism and the Social Effects of Cityness.' *International Journal of Urban and Regional Research* 47, no. 2 (February 27, 2023): 258–78.
48. Jiang, Bin, Lei Ding, and Xuejuan Fang. 2019. 'Sustainable Development of New Urbanization from the Perspective of Coordination: A New Complex System of Urbanization–Technology Innovation and the Atmospheric Environment' *Atmosphere* 10, no. 11: 652.
49. Johnson, Marc TJ, and Jason Munshi-South. 'Evolution of life in urban environments.' *Science* 358, no. 6363 (2017).
50. Joss, Simon, Frans Sengers, Daan Schraven, Federico Caprotti, and Youri Dayot. 'The Smart City as Global Discourse: Storylines and Critical Junctures Across 27 cities.' *Journal of Urban Technology* 26, no. 1 (2019): 3-34.
51. Katz, Larissa. 'Exclusion and Exclusivity in Property Law.' *The University of Toronto Law Journal* 58, no. 3 (2008): 275–315.
52. Kim, Sangmoo. 'Public Spaces - Not a 'Nice to Have' but a Basic Need for Cities.' World Bank Blogs, March 30, 2015. <https://blogs.worldbank.org/endpovertyinsouthasia/public-spaces-not-nice-have-basic-need-cities>.
53. Kundoo, Anupama. 'Auroville: An Architectural Laboratory.' *Architectural Design* 77, no. 6 (November 2007): 50–55.
54. Kundoo, Anupama. 'Sustainable Development and Integrated Planning.' *Journal of the Indian Institute of Architects*, July 2001.
55. Kundoo, Anupama. 'Urban Development: Options for Urbanization.' *Survey of the Environment*, 2008, 94–98.
56. Kundu, Amitabh. 'National Commission on Urbanisation: Issues and Non-Issues.' *Economic and Political Weekly* 24, no. 21 (1989): 1185–88.
57. Kurvinen, Antti, and Arto Saari. 'Urban Housing Density and Infrastructure Costs.' *Sustainability* 12, no. 2 (January 8, 2020): 1–24.

58. Lam, Sharon. 'The Unreliable Utopia of Auroville's Architecture.' *Arch Daily*, October 28, 2016.
59. Languillon-Aussel, Raphaël. 'Digitalization of Public Spaces. The Great Urban Change?' *Journal of Urban Research* 22 (December 15, 2021).
60. Lehmann, Steffen. 'Sustainable Urbanism: Towards a Framework for Quality and Optimal Density?.' *Future Cities and Environment* 2 (2016): 1-13.
61. Levy, Caren, Alexandre Apsan Frediani, Stephanie Butcher, Camila Cociña, and Michele Acuto. 'Addressing Urban Inequalities II: Discursive and Material Practices through Scale.' *Environment and Urbanization* 35, no. 1 (2023): 3-11.
62. Majumdar, Anu. 'Auroville: The Way Forward.' *AWARE Auroville*, October 12, 2022. <https://awareauroville.com/auroville-the-way-forward/>.
63. Majumdar, Anu. 'Correcting the Auroville Story: Environmental Hardliners Stall a Unique Urban Experiment.' *Open The Magazine*, December 8, 2021.
64. McFarlane, Colin. 'De/Re-Densification: A Relational Geography of Urban Density.' *City* 24, no. 1-2 (March 20, 2020): 314-24.
65. McGranahan, Gordon, and David Satterthwaite. 'Urbanisation Concepts and Trends.' *International Institute for Environment and Development*, June 2014, 1-28.
66. Mittal, Muktesh. 'Technology for Planned Urbanization.' *The Smart City Journal*, April 1, 2021.
67. Monstadt, J., & Coutard, O. (2019). 'Cities in an Era of Interfacing Infrastructures: Politics and Spatialities of the Urban Nexus.' *Urban Studies* 56(11): 2191-2206.
68. Moses, David. "Participatory Urban Design Tools: Portfolio." Supervised by Miho Mazereeuw and Aditya Barve. MIT Tata Centre, n.d. <https://tatacenter.mit.edu/portfolio/participatory-urban-design-tools/>.
69. Mouggiakou, Eleni, Anastasia Christaki, Giouli Athousaki, Theodoros Vakkas, George Velegarakis, Pantelis Mitropoulos, Thanos Andritsos, et al. "Participatory Urban Planning through Online webGIS Platform: Operations and Tools." *ICEGOV' 20 Proceedings of the 13th International Conference on Theory and Practice of Electronic Governance*, September 2020, 831-34.
70. Muellbauer, John, and Anthony Murphy. 'Housing Markets and the Economy: The Assessment.' *Oxford Review of Economic Policy* 24, no. 1 (March 1, 2008): 1-33.
71. Münster, Sander, Christopher Georgi, Katrina Heijne, Kevin Klamert, Jörg Rainer Noennig, Matthias Pump, Benjamin Stelzle, and Han van der Meer. "How to Involve Inhabitants in Urban Design Planning by Using Digital Tools? An Overview on a State of the Art, Key Challenges and Promising Approaches." *Procedia Computer Science* 112 (2017): 2391-2405.
72. Norris, Michelle, and Julie Lawson. 'Tools to Tame the Financialisation of Housing.' *New Political Economy* 28, no. 3 (September 25, 2022): 363-79.
73. Pafka, Elek. 'Multi-Scalar Urban Densities: From the Metropolitan to the Street Level.' *Urban Design International* 27 (March 2022): 53-63.
74. Pafka, Elek. 'Multi-Scalar Urban Densities: From the Metropolitan to the Street Level.' *URBAN DESIGN International* 27 (February 19, 2020): 53-63.
75. Parthasarthy, Anusha. 'Building with a View.' *The Hindu*, March 22, 2013.

76. Pereira, Gabriela Viale, Gregor Eibl, and Peter Parycek. 'The Role of Digital Technologies in Promoting Smart City Governance: The Case of SmartGov: Research in Progress.' *Proceedings of The 2018 Web Conference Companion (WWW'2018 Companion)*, 2018.
77. Pintos, Paula. 'Humanscapes Habitat Urban Living: Auroville Design Consultant.' *Arch Daily*, 2018.
78. Redfield, Robert, and Milton B. Singer. 'The Cultural Role of Cities.' *Economic Development and Cultural Change* 3, no. 1 (1954): 53-73.
79. Ren, Xuefei. 'Book Review: Amita Bhide and Himanshu Burte (Eds.) 2018: Urban Parallax: Policy and the City in Contemporary India. Delhi: Yoda Press.' *International Journal of Urban and Regional Research* 44, no. 1 (January 14, 2020): 180–180.
80. *The Economics of Urban Form: A Literature Review*. Rep. UN-Habitat, n.d.
81. Resnik, David B. 'Urban Sprawl, Smart Growth, and Deliberative Democracy.' *American Journal of Public Health* 100, no. 10 (October 2010): 1852–56.
82. Sareen, Siddharth, and Katinka Lund Waagsaether. 'New Municipalism and the Governance of Urban Transitions to Sustainability.' *Urban Studies* 60, no. 11 (September 5, 2022): 2271–89.
83. Saßmannshausen, Sheree May, Jörg Radtke, Nino Bohn, Hassan Hussein, Dave Randall, and Volkmar Pipek. "Citizen-Centered Design in Urban Planning: How Augmented Reality Can Be Used in Citizen Participation Processes." *Designing Interactive Systems Conference 2021*, June 28, 2021, 250–65.
84. Satterthwaite, David. 'A new urban agenda?.' *Environment and Urbanization* 28, no. 1 (2016): 3-12.
85. Savini, Federico. 'Maintaining Autonomy: Urban Degrowth and the Commoning of Housing.' *Urban Studies* 60, no. 7 (October 5, 2022): 1231–48.
86. Scott, Allen J., and Michael Storper. 'The Nature of Cities: The Scope and Limits of Urban Theory.' *International Journal of Urban and Regional Research* 39, no. 1 (March 31, 2014): 1–15.
87. Seto, Karen C., Michail Fragkias, Burak Güneralp, and Michael K. Reilly. 'A Meta-Analysis of Global Urban Land Expansion.' *PloS one* 6, no. 8 (2011): e23777.
88. Soja, Edward. 'The City and Spatial Justice.' *Justice spatiale/Spatial justice* 1, no. 1 (2009): 1-5.
89. Stauskis, Gintaras. "Development of Methods and Practices of Virtual Reality as a Tool for Participatory Urban Planning: A Case Study of Vilnius City as an Example for Improving Environmental, Social and Energy Sustainability." *Energy, Sustainability and Society* 4, no. 7 (April 17, 2014): 1–13.
90. Suiter, Jane, David M Farrell, and Eoin O'Malley. 'When Do Deliberative Citizens Change Their Opinions? Evidence from the Irish Citizens' Assembly.' *International Political Science Review* 37, no. 2 (September 11, 2014): 198–212.
91. Tacoli, Cecilia. 'The Links Between Urban and Rural Development.' *Environment and urbanization* 15, no. 1 (2003): 3-12.
92. Taubenböck, Hannes, Standfuß, Ines, Klotz, Martin, and Michael Wurm. 'The Physical Density of the City – Deconstruction of the Delusive Density Measure with Evidence

- from Two European Megacities.’ *ISPRS International Journal of Geo-Information* 5, no. 11 (2016): 206.
93. Teaford, Jon C. ‘Review Essay - Stopping Sprawl.’ *International Journal of Urban and Regional Research* 32, no. 3 (2008): 745–48.
 94. Thorpe, Amelia, and Bronwen Morgan. ‘Prefigurative Legality: Transforming Municipal Jurisdiction.’ *Urban Studies* 60, no. 11 (July 22, 2022): 2096–2115.
 95. Truong, Quang, Minh Nguyen, Hy Dang, and Bo Mei. ‘Housing Price Prediction via Improved Machine Learning Techniques.’ *Procedia Computer Science* 174 (2020): 433–42.
 96. Walsky, Tesia, and Neelakshi Joshi. ‘Realizing Utopia: Auroville’s Housing Challenges and the Cost of Sustainability.’ *Abacus* 8, no. 1 (2013): 1-8.
 97. Wang, Jing, Dang Que Nguyen, Tatiana Bonkalo, and Oleg Grebennikov. “Smart Governance of Urban Data.” *E3S Web of Conferences* 301, no. 05005 (2021).
 98. White, Iain. ‘Rigour and Rigour Mortis? Planning, Calculative Rationality, and Forces of Stability and Change.’ *Urban Studies* 57, no. 14 (December 17, 2019): 2885–2900.
 99. Wirth, Louis. ‘Urbanism as a Way of Life.’ *American Journal of Sociology* 44, no. 1 (1938): 1–24.
 100. Xue, Jin. ‘Is eco-village/urban village the future of a degrowth society? An urban planner’s perspective.’ *Ecological Economics* 105 (September 2014): 130-138.
 101. Yin, ChuanTao, Zhang Xiong, Hui Chen, JingYuan Wang, Daven Cooper, and Bertrand David. ‘A literature survey on smart cities.’ *Sci. China Inf. Sci.* 58, no. 10 (2015): 1-18.

Reports

1. ‘Auroville - a Way Forward!’ In *Collaborative January Sessions 2019*. Auroville: Auroville International, 2019. https://wiki.auroville.org.in/wiki/Town_planning.
2. ‘First Master Plan 1968.’ Auroville Centre for Urban Research (ACUR). Accessed 2023. <https://www.auroville.info/ACUR/templates/research.htm#1968>.
3. ‘Full Report: Power of Collective Aspiration.’ In *Auroville Retreat, 2015* (on file).
4. ‘Minutes of the Residents’ Assembly Meeting on the Presentation of the Elaboration of the Master Plan, 7th December 1999.’ *Auroville News*, December 18, 1999
5. ‘Panel Discussion: Perspectives 2000- Direction for Rural and Urban Development.’ *Auroville News*, July 31, 1999 (on file).
6. ‘Residents Assembly on Master Plan Postponed Until Tuesday 7th December, 5 PM.’ *Auroville News*, November 27, 1999 (on file).
7. Advisory Committee for Reforms in Urban Planning Capacity in India. Rep. *Reforms in Urban Planning Capacity in India: Final Report*. Niti Aayog, September 16, 2021. <https://www.niti.gov.in/sites/default/files/2021-09/UrbanPlanningCapacity-in-India-16092021.pdf>.
8. Agarwal, Ajay, Michael Norris, Benjamin Segal Daly, Dominik Matusik, Thomas Spolsky, Benjamin Goodge, Asia Pineau, et al. Rep. *Auroville Community Participation Framework*, 2016. https://aurorepo.in/id/eprint/4/1/Research_on_Community_Participation_Framework.pdf.

9. Aiyar, Suhasini, Harini Sampath, Martin S, and Manas. *Report of the Study to Identify Auroville's Development Priorities for 2021-2026: Directions for Growth with Development Policies, Planning and Programs*. Auroville: L'avenir d'Auroville- Town Development Council, 2021.
10. An Evolutionary Approach to the Development of Auroville, 15th March 1972, Box No. 1, Planning early years, Auroville Archives, Auroville, India.
11. Anger, Roger. 'Galaxy Model for the Auroville Township'. Presentation, Auroville, 1968. (on file).
12. Anger, Roger. Rep. *First Approach to the Town- Plan of the Study*. Auroville, 1969 (on file).
13. Anger, Roger. Rep. *Master Plan 1969: Detailed Description of the Galaxy Plan*. Auroville, 1969. (on file).
14. Anger, Roger. Rep. Translated by Gilles Guigan. *On Planning Auroville: Roger Anger's First Report to the Mother after His Acceptation of Her Work Offer*. Samasti, Auroville, India: Auroville Foundation, 1965. [https://wiki.auroville.org.in/w/images/7/71/1965.09.07 Rogers planning report %28 Eng%29.pdf](https://wiki.auroville.org.in/w/images/7/71/1965.09.07_Rogers_planning_report_%28Eng%29.pdf).
15. Auro Futures, Habitat/Housing, Box No. 2, Planning early years, Auroville Archives, Auroville, India.
16. Auroville First Phase of Development 1969 – 1974, Box No. 1, File No. 4, Early years 1972-1973, Auroville Archives, Auroville, India.
17. Auroville on the Move: First Realisation, Box No. 1, Planning early years, Auroville Archives, Auroville, India.
18. Auroville Town Development Council and Development Consultants Private Limited (Kolkata). Rep. *Electricity Master Plan for Auroville (Draft)*. Auroville Wiki, July 2014. [https://wiki.auroville.org.in/w/images/2/2e/2014.07 Electricity Master Plan draft.pdf](https://wiki.auroville.org.in/w/images/2/2e/2014.07_Electricity_Master_Plan_draft.pdf).
19. Auroville Town Development Council. 'Manifesting Mother's Dream: A strategic approach to implement Auroville's Galaxy Plan'. Presentation, Auroville (on file).
20. *Auroville Universal Township Integrated Master Plan Phase I*. Auroville: Land Use Coordination, 1999 ((on file).
21. Auroville's Future. 'Auroville Mobility: Planning Policy and Design Criteria for Movement, Traffic, and Roads.' Auroville, India, February 2005 (on file).
22. Ayar, Suhasini. Rep. *Auroville City Area: Land Suitability and Land Use Proposal*. Auroville: L'Avenir D'Auroville – Town Development Council, 2014.
23. Bahavana, Dhanya. Discussion paper on town planning and industrial zone, 1999, Auroville Archives, Auroville, India (uncatalogued).
24. Bernard, Alain. Rep. *Estimates for the Development Plan for Auroville during the 8th Five-Year Plan*. Auroville, India: Auroville Archives, n.d (uncatalogued).
25. Billinger, Hans, and Helmut Schmidt. Rep. *Auroville Mobility Concept*. Auroville, 2001 (on file).

26. Billinger, Hans, and Helmut Schmidt. Rep. *Auroville Mobility: Planning Policy and Design Criteria For Movement, Traffic and Roads*. Auroville: Auroville's Future, 2005 (on file).
27. Centre for Social Research (CSR). Rep. *Bicycle Friendly Area: Design Workshop At Auroville*. Auroville Wiki, 2009. <https://wiki.auroville.org.in/w/images/f/f1/AV-Mobility-report-july%2709-cept.pdf>.
28. Centre for Urban Research, Auroville Land Fund Symbol and Auroville Land Fund, Auroville Archives, Auroville, India (on file).
29. *Comprehensive Development Plan For Puducherry Planning Area - 2036*. Puducherry Planning Authority, October 31, 2019.
30. Development Group Report (Progress), 1994-1995, Auroville Archives, Auroville, India (uncatalogued).
31. Dhanya, Town Planning and Industrial Zone: Discussion paper on town planning, 1987, Auroville Archives, Auroville, India (uncatalogued).
32. Dharan, Lakshay. 'Critique of Auroville's Citizens' Assembly.' AWARE Auroville, April 30, 2023. <https://awareauroville.com/critique-of-aurovilles-citizens-assembly/>.
33. Dinur, Batel, and Alon Yakolchik. Rep. *Integral Sustainability Platform How Can Auroville Utilise Better Its Existing Resources and Aspire to Become Self-Sustainable?* Auroville: L'Avenir d'Auroville, 2009.
34. [Dream-catchers (a), 2007] Dreamcatchers. Rep. *Dreamcatching "Mobility" (March to May 2007): Pearls of Sessions*. Auroville Wiki, March 28, 2007. https://wiki.auroville.org.in/w/images/7/70/Dreamcatchers_Mobility_Pearls_March-May_2007.pdf.
35. [Dream-catchers (b), 2007] Dreamcatchers. 'Study on Crownways'. Presentation, Auroville, July 15, 2007.
36. Dutch Participation 1968-1981: file given by WIL on Dutch participation, Box No. 1, File No. 7, Planning early years, Auroville Archives, Auroville, India.
37. E Castro, Marta De Sousa. 'Auroville: The Sustainable Laboratory: An Alternative Human Settlement.' *UP Commons. Global access to UPC Knowledge*, October 15, 2020. <http://hdl.handle.net/2117/339429>.
38. European Strategy and Policy Analysis System (ESPAS). 'Global Trends to 2030: The Future of Urbanization and Megacities.' (2019): 1-17. <https://espas.secure.europarl.europa.eu/orbis/sites/default/files/generated/document/en/Think%20piece%20global%20trends%202030%20Future%20of%20Urbanisation.pdf>
39. Feduchi, Luis. *Detailed Development Plan 2014: Residential Zone Sector 1 & 2*. Auroville: Luis Feduchi Architect & Camilo Jose Cela University, 2014 (on file).
40. Herbert, Alan, Anshul Aggarwal, Helen Eveleigh, and Suryamayi Clarence-Smith. Rep. *Dreamweaving the Auroville Crown*. Auroville: Dreamweaving & Citizen Assembly Teams, 2022 (on file).
41. [IZa, 2018] International Zone (IZ). 'International Zone Presentation Task 1 & 2'. Presentation, Auroville, September 10, 2018 (on file).
42. [IZb, 2018] International Zone (IZ). 'Task 2- Master Plan and Planning Information Collection and Analysis'. Presentation, Auroville, September 10, 2018 (on file).

43. [IZc, 2018] International Zone (IZ). ‘Task 3-Services, Infrastructure, Networks, Acquiring & Implementation’. Presentation, Auroville, September 17, 2018 (on file).
44. [IZd, 2018] International Zone (IZ). ‘Task 4-Strategic Plan of the IZ Development’. Presentation, Auroville, September 17, 2018 (on file).
45. Joshi, Karn, and Pooja Solanki (CEPT University: Summer Internship Report). Rep. *Auroville Mobility Study*. Auroville Wiki, 2009.
<https://wiki.auroville.org.in/w/images/f/f1/AV-Mobility-report-july%2709-cept.pdf>.
46. Kalra, Bankim, Vidhya Mohankumar, Sripallavi Nadimpalli, Amit Haldar, Devaraj De Condappa, Soumyabrata Raut, and Minhaj Ameen. Rep. *Sustainable Regional Planning Framework for Puducherry, Viluppuram, Auroville & Cuddalore Final Report*. ADEME, INTACH & PondyCAN, 2012 (on file).
47. Keith, Michael, Neave O’Clery, Sue Parnell, and Aromar Revi. Rep. Edited by Francisco Obando. *The Future of the Future City? The New Urban Sciences and a PEAK Urban Interdisciplinary Disposition*. PEAK Urban, 2020.
48. Kundoo, Anupama. *Auroville City Centre Proposal*. Auroville, 2007 (on file).
49. L’avenir d’Auroville. Rep. *Report of L’avenir d’Auroville/TDC: January to May 2015*. AV Radio, June 4, 2015.
https://avradio.sgp1.digitaloceanspaces.com/wpcontent/uploads/import/2015_06_04_news_lilith_fashion_show_tdc_report_web_service_english.pdf.
50. L’avenir d’Auroville. Rep. *Road Map 2012: L’avenir’s Road Implementation Strategy*. Auroville Wiki, November 2009.
https://wiki.auroville.org.in/w/images/9/93/Road_Map_2012_11-23-09.pdf.
51. L’avenir d’Auroville. Rep. *Town Development Council – L’avenir: Report for the Governing Board*. Auroville Wiki, April 6, 2012.
https://wiki.auroville.org.in/w/images/a/ae/2012.04.06_TDC-Lavenir_Report_for_the_Governing_Board.pdf.
52. Mabilat, C, Pre-Study on Cost of Different Types of Roads and Related Topics, May 2001, Auroville Archives, Auroville, India (uncatalogued).
53. Maïni, Satprem. Tech. *Auroville Crown Road: Technical Evaluation Report- Follow up on the Initial Report*, August 16, 2022 (on file).
54. Ministry of Housing and Urban Affairs, Government of India. Rep. *Data Smart Cities: Empowering Cities Through Data*, 2019.
https://smartcities.data.gov.in/sites/default/files/DataSmart_Cities_Strategy_Print.pdf.
55. Mother’s View on International Zone, Box No. 1, Planning Early Years, Auroville Archives, Auroville, India.
56. Nightingale, David and Doctor-Pingel, Mona. ‘DreamCatching: as a Tool for Planning and Design (2005-2018)’. Presentation, Auroville (on file).
57. Notes from Shri Aurobindo’s and Mother’s Writing on Concept of Auroville, Box No. 1, Planning Early Years, Auroville Archives, Auroville, India.
58. OECD. Rep. *Rethinking Urban Sprawl: Moving Towards Sustainable Cities*. OECD Publishing, Paris, June 14, 2018.
59. OECD. Rep. *Smart City Data Governance: Challenges and the Way Forward*, October 13, 2023.

60. Olmstead, Nathan. 'Book Review: Frankenstein Urbanism: Eco, Smart and Autonomous Cities, Artificial Intelligence and the End of the City.' *Urban Studies* 60, no. 1 (December 8, 2022): 207–10.
61. P[Posch(e), 2011] osch, Karl-Heinz. European Platform on Mobility Management. 'Bus Rapid Transit System'. Presentation, Auroville Wiki, March 22, 2011.
62. Peker, CS, Auroville Land Fund: Land Purchase for Auroville - Progress Report for 1994 and Outlook for 1995, February 1995, Auroville Archives, Auroville, India.
63. Plan for Development of Auroville Lands (Contd.), Box No. 1, Planning early years, Auroville Archives, Auroville, India.
64. Planning Early Years 1968-1974, Box No. 1, Auroville Archives, Auroville, India.
65. Planning early years: Auroville as an expression of Auroville and Aurovilians, n.d., Box No. 1, Auroville Archives, Auroville, India.
66. Planning Early Years: Before Inauguration and After Up to 1971, Box No. 1, File No. 1, Auroville Archives, Auroville, India.
67. Planning Group. 'Auroville Planning: Directions for interpreting the Galaxy'. Presentation, Auroville Wiki, April 2006.
68. Planning: Auroville Town of Fraternity, Box No. 1, Planning Early Years, Auroville Archives, Auroville, India.
69. [Posch(a), 2011] Posch, Karl-Heinz. European Platform on Mobility Management. 'Auroville Mobility Team Update'. Presentation, Auroville Wiki, March 2011.
70. [Posch(b), 2011] Posch, Karl-Heinz. European Platform on Mobility Management. 'Shared Space'. Presentation, Auroville Wiki, March 2011.
71. [Posch(c), 2011] Posch, Karl-Heinz. European Platform on Mobility Management. 'Integrated Mobility Management and Land Use Planning- Sihl City Model'. Presentation, Auroville Wiki, March 2011.
72. [Posch(d), 2011] Posch, Karl-Heinz. European Platform on Mobility Management. 'Integrated Mobility Management and Land Use Planning- Site Based Mobility Management'. Presentation, Auroville Wiki, March 2011.
73. [Posch(f), 2011] Posch, Karl-Heinz. European Platform on Mobility Management. 'Sustainable Urban Mobility Plan'. Presentation, Auroville Wiki, March 22, 2011.
74. [Posch(g), 2011] Posch, Karl-Heinz. European Platform on Mobility Management. 'Auroville – a car free city?'. Presentation, Auroville Wiki, March 25, 2011.
75. [Posch(h), 2011] Posch, Karl-Heinz. European Platform on Mobility Management. 'Auroville – Results from the Mobility Workshop 2011'. Presentation, Auroville Wiki, March 28, 2011.
76. Prashant, Suhasini, Lata, Dharmesh, and Tejaswini. Rep. *Auroville Crownway Study*, 2021 (on file).
77. Preparation of the Development Plan for the Visiting Committee, 1988, Auroville Archives, Auroville, India.
78. Ramanathan, S., and Prabhat M. Poddar, Engineering Aspects of Auroville: A Report for the Auroville Planning Group, Box No. 1, Planning early years, Auroville Archives, Auroville, India.
79. *Asia Urbs Auroville Master Plan: Directions for Growth*. Rep. Auroville, 2003. https://wiki.auroville.org.in/wiki/Town_planning

80. *Auroville Development Scheme: 1988-1995*. Rep. Auroville, India: Auroville Foundation, 1988. https://wiki.auroville.org.in/w/images/9/92/Auroville_Development_Scheme_1998-1995.pdf.
81. *Earthen Architecture for Sustainable Habitat: Auroville's Case Study*. Rep. Auroville Building Centre (Earth Unit).
82. *Global Review of Smart City Governance Practices: Final Report*. Rep. UN Habitat, 2022. https://unhabitat.org/sites/default/files/2022/11/grscgp_design_final8.pdf.
83. *Global Smart Cities: Humanity, Technology and Sustainability*. Rep. United Nations Public Administration Network (UNPAN), 2020. <https://unpan.un.org/sites/unpan.un.org/files/Global%2BSmart%2BCities%2B2020.pdf>.
84. *Implementation and Development Phasing Programme (IDPP): 2013-2018*. Rep. Auroville: L'Aevnir d'Auroville, 2013.
85. *Integral Sustainability Platform: Strategy and Purpose*. Rep. Auroville Wiki, 2010. https://wiki.auroville.org.in/w/images/8/8e/ISP_Mobility_-_purpose_%2B_strategy_0410.pdf.
86. *Science, Technology and Innovation for Sustainable Urbanization: UNCTAD Current Studies on Science, Technology and Innovation No. 10*. Rep. United Nations Conference On Trade and Development (UNCTAD), 2014. https://unctad.org/system/files/official-document/dtlstict2014d2_en.pdf.
87. *Smart City Strategies: A Global Review*. Rep. ARUP, 2017. <https://www.arup.com/perspectives/publications/research/section/smart-city-strategies-a-global-review>.
88. *Terms of Reference*. Rep. Auroville, India: Town Development Council, 2017. 'Multidisciplinary Forum: Mobility.' In *Dreamweaving the Auroville Crown*. Auroville: Dreamweaving Team, 2022 (on file).
89. *Work Proposal Assessment of Planning Needs of Auroville*. Rep. Vastu Shilpa Foundation, 2021.
90. Report of the National Commission on Urbanisation Vol III § (1988). Rep. <https://indianculture.gov.in/reports-proceedings/report-national-commission-urbanisation-vol-iii>.
91. Revi, Aromar. Rep. *Auroville Mission Notes*. Auroville, 2007 (on file).
92. Roads in Auroville, 1984-1995, File No. 2, Auroville Archives, Auroville, India.
93. Roy, Pavitra. Rep. *Capacity Building Plan for L'Avenir ATDC*. Auroville Town Development Council, 2022.
94. Satprem, Leg-Aum House – Auroville Unit Moveable House, n.d., Auroville Archives, Auroville, India.
95. Schmidt, Helmut. Rep. *On Public Spaces and the Development of Auroville's Crown*. Auroville Wiki, February 2003. <https://wiki.auroville.org.in/w/index.php?title=Mobility>.
96. Sobel, Jyoti, American Fund for Auroville (AFFA) and Others from Norman Dowsett's Papers, Box No. 1, File No. 5, Planning early years, February 1998, Auroville Archives, Auroville, India.

97. UN Habitat. Rep. *Tools to Support Participatory Urban Decision Making*, July 2001.
98. World Economic Forum, Deloitte, and Ministry of Housing and Urban Affairs, Government of India. Rep. *Technology and Data Governance in Cities Indian Smart Cities at the Forefront of the Fight Against COVID-19: Insight Report*, December 2020.
https://www3.weforum.org/docs/WEF_Technology_and_Data_Governance_in_Smart_Cities_India_2020.pdf.
99. Auroville Progress Report March 1969, Box No. 1, Planning early years, Auroville Archives, Auroville, India.
100. Auroville Planning Group, General Report, March 1972, Auroville Archives, Auroville, India.
101. Constructions, Configurations, Collaborations: January 1973, Box No. 1, Planning early years, Auroville Archives, Auroville, India.
102. 'Call for a Resident Assembly.' *Auroville News*, November 29, 1999.
103. Auroville Land Situation, April 2000, Auroville Archives, Auroville, India (uncatalogued).
104. *Module 6: Public Space*. UN Habitat, February 2019.
https://unhabitat.org/sites/default/files/2020/07/indicator_11.7.1_training_module_public_space.pdf.
105. *What Is a City?* Rep. UN Habitat, June 2020.
https://unhabitat.org/sites/default/files/2020/06/city_definition_what_is_a_city.pdf.
106. *Housing Survey 2020*. Rep. Auroville Wiki, November 6, 2020.
https://wiki.auroville.org.in/w/images/5/51/2020.11.06_Housing_Survey_summary_of_findings.pdf.
107. Town Planning and the Galaxy Concept: 21 Years After, February 1989, File No. 10, Auroville Archives, Auroville, India.
108. Vardharajan, Document related to Project Coordination, 2nd May 1973, Auroville Archives, Auroville, India.

Correspondence and Administrative Documents

1. [L'avenir, 2013a] P., Abha. Rep. *TAG/WC/TDC/AVF/GB Meeting Report July 29th, 2-3 Pm, Town Hall*. Auroville, India: L'avenir/TDC Communication, 2013.
2. 'Auroville Master Plan Protection: New Town Development Authority'. Presentation, Auroville, February 17, 2015.
3. 'Auroville Planning and Development Group Responds by Conditional Allotting.' September 13, 1996 (on file).
4. Advisory Committee. 'Recommendations of the Advisory Committee of L'Avenir d'Auroville: an aesthetic journey into creative Urban Planning'. Presentation, Auroville, November 27, 2010.
5. Anand, Harjit Singh, and Toine van Megen. Rep. *Recommendations of Members of the TDC Advisory Group*. Auroville, India: Auroville Town Development Council, November 8, 2013.
6. Anonymous (on file). Rep. *Auroville Planning List of Studies (Non-Exhaustive, to Be Completed)*, December 2021.

7. Auroville Foundation, Constitution of Auroville Town Development Council Advisory Group (TAG). Standing Order No. 9, Auroville: September 7, 2011.
8. Auroville Foundation. 'Constitution of Auroville Town Development Council.' Notification. Tamil Nadu, June 1, 2022. 'The Gazette of India.' Published by the Government of India Press.
9. Auroville Land Stewardship Trust, File No. 1, Auroville Land Correspondence, Auroville Archives, India.
10. Auroville Town Development Council, Sauro Mezzetti. Letter to Dharmendra Pratap Yadav (I.A.S.) Secretary, Tamil Nadu Housing and Urban Development Department. 'Notification of Auroville NTDA.' Auroville, India, February 23, 2016.
11. Auroville Town Development Council, Sauro Mezzetti. Letter to Dharmendra Pratap Yadav (I.A.S.) Secretary, Tamil Nadu Housing and Urban Development Department. 'Notification of Auroville NTDA.' Auroville, India, March 19, 2016.
12. *Auroville Universal Township Master Plan (Perspective: 2025)*. Auroville Foundation and Town and Country Planning Organisation, Government of India, 2001.
13. Chairman, Auroville Town Development Council, B.V. Doshi. Letter to K. Phanindra Reddy IAS (Secretary, Tamil Nadu Housing and Urban Development Department). 'Auroville Master Plan Implementation.' Auroville, India, February 18, 2012.
14. Chairman, Auroville Town Development Council, B.V. Doshi. Letter to K. Phanindra Reddy IAS (Secretary, Tamil Nadu Housing and Urban Development Department). 'Auroville Master Plan for Surrounding Areas.' Auroville, India, February 18, 2012.
15. Chairman, Auroville Town Development Council, Balkrishna Doshi. Letter to Dr. Karan Singh. 'Statutory Recognition of Land Use in the Auroville Master Plan Area.' Auroville, India, August 5, 2015.
16. Commissioner of Town and Country Planning, A. Karthik (I.A.S.). Letter to B.V. Doshi Chairman, Auroville Town Development Council. 'Auroville Foundation- Layout Approval around Auroville-Inviting for Discussion.' Chennai, India, September 15, 2012.
17. Dattatri, G. Letter to Mr. M. Ramaswamy (I.A.S.) Secretary, Auroville Foundation. 'Recommendations for Action to Be Taken Consequent to Notification of Auroville Master Plan.' Chennai, India, November 14, 2010.
18. Deputy Secretary to Government of Tamil Nadu (Housing and Urban Development Department), Thiru. K. Thyagarajan (B.A.). Letter to The Secretary, Auroville Foundation. 'Lands around Auroville-Protection from Unseemly Development-Concession-Position-Intimated.' Chennai, India, July 26, 2002.
19. Deputy Secretary, Housing and Urban Development Department, A. Mohan Singh (B.A.). Letter to The Director of Town and Country Planning, Tamil Nadu. 'Remarks Called for Urban Development- New Town Development-Auroville Foundation- Declaration of New Town Development Area Section 10(1)(c) of the Tamil Nadu Town and Country Planning Act, 1971.' Chennai, India, November 22, 2019.
20. *Development Plan 2014-2015*. Auroville: Town Development Council, 2014 (on file).
21. District Collector, Villupuram District, M. Lakshmi (I.A.S.). Letter to The Director, Town and Country Planning. 'Submitting the Required Concept to the Government for

- the Creation of a New Auroville Development Authority.’ Villupuram, Tamil Nadu, October 25, 2015.
22. *Green Belt Land Use Plan. Auroville Town Development Council, 2015* (on file).
 23. Housing and Urban Development Department, Government of Tamil Nadu, Layout approval around Auroville- Acquisition for Auroville Foundation-Guidelines Issued (Abstract). G.O (MS) No. 6, Tamil Nadu: January 20, 2003.
 24. Jayalalithaa, J. Letter to Dr. L. M. Singhvi. Chennai, India, March 1, 2002.
 25. L’Avenir d’Auroville, The Auroville Township Planning and Development Research Organisation. Mandate. 2007.
http://wiki.auroville.org.in/w/images/6/6b/LAvenir_dAuroville_TDC_Mandate_2007.pdf.
 26. *L’Avenir Work Agenda 2014*. Auroville: L’Avenir d’Auroville, 2014 (on file).
 27. L’avenir and Auroville Council. ‘Report of the Land Protection workshops - Call for Community Feedback.’ *Auroville News & Notes* (No. 683), January 21, 2017.
 28. Letter to Auroville Town Development Council. *Clearing of Right of Ways 29 February 2012*. Auroville ICITI Project, Auroville Electrical Service, Auroville Water Service, Auroville Telephone Service & Auroville Road Service, 2012 (on file).
 29. Letter to Dr. Karan Singh, Dr. Doshi and Members of the Governing Board, Auroville Foundation. *Proposal from the Working Committee Re: Restructuring TDC*. Auroville: Working Committee of the Residents’ Assembly, 2016 (on file).
 30. Letter to Shri. B. V. Doshi, Chairman, Auroville Town Development Council. *Clearing of Right of Ways (ROW) 27 March 2012*. Auroville ICITI Project, Auroville Electrical Service, Auroville Water Service, Auroville Telephone Service, Auroville Road Service & Aqua Engineers, 2012 (on file).
 31. Letter to Shri. P. R. Srinivasamurty, Acting Secretary, Auroville Foundation. *Clearing of Right of Ways*. Auroville: Auroville Electrical Service, 2020 (on file).
 32. Letter. *Scheme for the development of Auroville*. Auroville: Auroville Trust, Auroville Archives, 07 February 1987 (on file).
 33. Megen, Toine Van. *NTDA Questionnaire*. Auroville, India, 2019.
 34. Megen, Toine Van. *Recommendation and Statements by Land Protection Group Comments, Questions and the Way Forward*. Auroville, India, April 29, 2018.
 35. Megen, Toine van. Rep. *Auroville Master Plan Enforcement Options*. Auroville, India, September 25, 2012.
 36. Megen, Toine van. Rep. *Auroville Town Development – the Way Forward*. Auroville, India: Auroville Town Development Council, n.d.
 37. Megen, Toine van. Rep. *Note on Master Plan*. Auroville, India: Auroville Town Development Council, October 20, 2011.
 38. Megen, Toine van. Rep. *Proposal for the Constitution of an Auroville New Town Development Authority under the Tamil Nadu Town and Country Planning Act 1971*. Auroville, India, February 18, 2013.
 39. *Memo on NTDA*. Auroville, India: Auroville Town Development Council, 2014.
 40. Ministry of Human Resource Development, Department of Higher Education, The Gazette of India, Standing Order No. 6/2011 Dated 1st May 2011 Constitution of Auroville Town Development Council § (2011).

41. Ministry of Human Resource Development, Department of Higher Education, The Gazette of India, Standing Order NO.1/2019 dated 4th June 2019. Constitution of Auroville Town Development Council (2019) (on file).
42. *Notes from Meeting with Secretary, Housing and Urban Development.* Auroville, India, June 10, 2019.
43. *Action List Prepared after Meetings with TDC Advisory Group on 28 and 29th July 2013.* Rep. Auroville, India: Auroville Town Development Council, 2013.
44. *Auroville Housing Policy.* Rep. Auroville: Auroville Foundation, 2011 (on file).
45. *Auroville Land Policy.* Rep. Auroville: Auroville Foundation, 1999 (on file).
46. *Findings and Recommendations.* Rep. Auroville, India: Auroville Land Protection Status Study Group, February 4, 2014.
47. *Housing Mandate: Governing the Allocation and Management of Residential Property Owned by the Auroville Foundation.* Rep. FAMC, April 16, 2021.
48. *Need For Further Detailed Development Of Galaxy Plan: Draft.* Rep. Auroville: Auroville Town Development Council and Vastu Shilpa Foundation, 2015 (on file).
49. *Report of the Land Protection Team.* Auroville, India: Land Protection Group, January 2020.
50. *Report to the Secretary on Land Use Regulation.* Auroville, India, 2016.
51. Secretary Auroville Foundation, G. Seetharaman. Letter to Rajesh Lakhoni (I.A.S.) Principal Secretary, Housing and Urban Development, Tamil Nadu. 'NTDA for the Auroville Master Plan Area.' Auroville, India, October 4, 2019.
52. Secretary Auroville Foundation, Mohan Verghese Chunkath I.A.S. (Retd.). Letter to Dr. Beela Rajesh, Commissioner Town and Country Planning Tamil Nadu. Auroville, India, June 25, 2018.
53. Secretary Auroville Foundation, Mohan Verghese Chunkath I.A.S.(Retd.). Letter to S. Krishnan (I.A.S.) Principal Secretary Housing and Urban Development Tamil Nadu. Auroville, India, September 19, 2018.
54. Secretary, Auroville Foundation, Mr. M. Ramaswamy (I.A.S.). Letter to The Collector, Villupuram District. 'Auroville International Township-Master Plan Approved-Town Development Council-Formed.' Auroville, India, June 13, 2011.
55. Secretary, Tamil Nadu Housing and Urban Development Department, Dharmendra Pratap Yadav (I.A.S.). Letter to Director of Town and Country Planning. 'Proposal Called for New Town Development Auroville- Declaration of Local Planning Area under 10(1)(b) and New Town Development Area under Section 10(1)(c) of the Tamil Nadu Town and Country Planning Act, 1971.' Chennai, India, July 15, 2016.
56. Secretary-in-charge (Auroville Foundation), P. R. Srinivasamurty. Letter to Thiru. K. Thyagarajan (B.A.), Deputy Secretary to Government of Tamil Nadu (Housing and Urban Development Department). 'Lands around Auroville-Protection from Unseemly Development-Concession-Position-Intimated.' Auroville, India, August 30, 2002.
57. Singhvi, L. M. Letter to Dr. Jayalalithaa. New Delhi, India, February 16, 2002.
58. Special Commissioner of Town and Country Planning, (I.A.S.) Gurusurthi, Thiru S. Letter to The Secretary to Government Housing and Urban Development Department, Chennai. 'Directorate of Town and Crown Planning- Master Plans- Auroville

- International Township-Declaration of Planning Area, Constitutions of Authority under Tamil Nadu Town and Country Planning Act 1971.’ Chennai, India, July 1, 2002.
59. Stein, David. *Commentary on the Auroville NTDA Proposal*. Auroville, India, December 13, 2016.
 60. Town and Country Planning Organization. Rep. Urban and Regional Development Plans Formulation and Implementation (URDPFI) Guidelines. Ministry of Urban Development, Government of India, 2015. [https://mohua.gov.in/upload/uploadfiles/files/URDPFI%20Guidelines%20IIA-IIB\(3\).pdf](https://mohua.gov.in/upload/uploadfiles/files/URDPFI%20Guidelines%20IIA-IIB(3).pdf).
 61. Under Secretary & Secretary-in-charge, Auroville Foundation, P. R. Srinivasamurty. Letter to Rajesh Lakhoni (I.A.S.) Principal Secretary, Housing and Urban Development, Tamil Nadu. ‘District Planning Authority, Auroville Foundation.’ Auroville, India, February 7, 2020.
 62. Under Secretary & Secretary-in-charge, Auroville Foundation, P. R. Srinivasamurty. Letter to Rajesh Lakhoni (I.A.S.) Principal Secretary, Housing and Urban Development, Tamil Nadu. ‘Preventing Unauthorized Development in Auroville Bio-Region.’ Auroville, India, February 12, 2020.
 63. Under Secretary Auroville Foundation, P. R. Srinivasamurty. Letter to Mohan Verghese Chunkath Chief Secretary to Government of Tamil Nadu. ‘Auroville Master Plan.’ Auroville, India, August 27, 2014.
 64. Working Committee of the Residents’ Assembly, Carl Thieme. Letter to Prof. M. S. Swaminathan. Auroville, India, June 18, 2015.
 65. Pougault, Jean. Letter dated 4th June 1988 regarding ‘Acquisition of Road Leading to Edayanchavadi to Bommayapalayam.’ AUR/ADM.0/136/88, dated 2.6.88. From GN Chaturvedi/Tahsildar Vanur (on file)
 66. Letter dated August 19, 1996, to Development Group from Radha and Boomi (on file).
 67. Letter dated December 14, 1998, to Land Fund, Development Group, and Planning Group (on file).
 68. *Meeting of 03-10-2012 at the Town Hall*. Auroville: Infrastructure Services Coordination Team, 2012 (on file).
 69. The Gazette of India: Extraordinary, STANDING ORDER NO. 01/2022 dated 1st June 2022 (Replacing the Standing Order No. 01/2019 dated 4th June, 2019): Constitution of Auroville Town Development Council (2022) (on file).
 70. [L’avenir, 2013b] P., Abha. Rep. *TAG/TDC Interaction July 28th-29th Outcomes and Action List*. Auroville, India: L’avenir/TDC Communication, 2013.

Maps, Drawings and Planning Documents

1. *Crown RoW-cross section with infrastructure corridors*. Auroville Town Development Council, Aurinoco, AVES, Auroville Water Service & Auroville Road Service, November 4, 2021 (on file).
2. Elkabbach, Jean-Pierre, Nicole Avril, and Maurice Dugowson. *Auroville Galaxy - Interview With Roger Anger*. Auroville—a documentary. YouTube, 1973. <https://www.youtube.com/watch?v=uvjVVIntczs>.

3. Julia, and Pavneet. 'Auroville Green Belt Land Use Map.' Map. *Draft Auroville Green Belt Zoning Map*. Auroville, 2017 (on file).
4. Map. *Crown Road Section Final: Infrastructure General Layout Design*. Aqua Engineers and Auroville Town Planning and Development Research Organization, 2012 (on file).
5. Patrick. 'TDC Presentation to Gov. Board.' Auroville Radio, November 2, 2013. <https://www.aurovilleradio.org/tdc-presentation-to-gov-board/>.
6. *Service Corridor Drawings: Crown Road*. Auroville Town Development Council, September 8, 2016 (on file).
7. Sindhuja. *Right of Way Cross Section: Crown Road Plan showing Schematic Road Layout, Section showing Infrastructure Corridor Details*. Auroville Town Development Council, February 21, 2020 (on file).

Miscellaneous

1. Mindmixer. Accessed 2023. <https://www.mindmixer.com/>.

C. Education and Research

Books

1. Mother, The. *On Education*. Vol. 12. *Collected Works of The Mother*. Auroville, India: Sri Aurobindo Ashram Publication Department, 2002 (CWM).
2. *After School*. Auroville, India: Sri Aurobindo International Institute of Educational Research, 2021 (on file).
3. Aggarwal, Sanjeev. *Taking Care of Preschool Children: The Mother's Vision and the Auroville Experience*. Auroville, India: Sri Aurobindo International Institute of Educational Research (SAIIER), n.d.
4. Aikya. *Glimpses of Wonder: Children in Auroville Creating Worlds on Sand*. Auroville, India: Sri Aurobindo International Institute of Educational Research (SAIIER), 2015.
5. Botha, Adriana, Hanlie Smuts, and Carina de Villiers. 'Applying Diffusion of Innovation Theory to Learning Management System Feature Implementation in Higher Education: Lessons Learned.' Chapter. In *Emerging Technologies for Education Third International Symposium, SETE 2018*, edited by Tianyong Hao, Wei Chen, Haoran Xie, Wanvimol Nadee, and Rynson Lau, 56–65. Lecture Notes in Computer Science. Cham, Germany: Springer, 2018.
6. Fouladoux, Odile. *Building with Blocks at the Auroville Kindergarten*. Auroville, India: Auroville Press & SAIIER, 2013.
7. Gipps, Caroline, and Gordon Stobart. 'Alternative Assessment.' Chapter. In *International Handbook of Educational Evaluation*, edited by Thomas Kellaghan and Daniel L. Stufflebeam, 549–75. Kluwer International Handbooks of Education. Dordrecht, Netherlands: Springer, 2012.
8. Joshi, Kireet, ed. *The Aim of Life*. Auroville, India: Auroville Press & SAIIER, 1986.
9. Joshi, Kireet, ed. *The Good Teacher and The Good Pupil*. Auroville, India: Sri Aurobindo International Institute of Educational Research, 1988.
10. Joshi, Kireet. *Curriculum Handbook: Indian Institute of Teacher Education*, n.d.
11. Marti, Aloka, and Joan Sala. *Awareness through the body in the kindergarten - First Step towards cultivating attention, relaxation and self-awareness*. Auroville, India: Sri Aurobindo International Institute of Educational Research (SAIIER), 2020.
12. Marti, Aloka, and Joan Sala. *Awareness through the body: A way to enhance concentration, relaxation and self-knowledge in children and adults*. Auroville, India: Sri Aurobindo International Institute of Educational Research (SAIIER), 2006.
13. *Passage: by Students and Teachers of Last School*. Auroville, India: Sri Aurobindo International Institute of Educational Research (SAIIER), 2010.
14. *Reflections on Teaching in Auroville Schools: A collection of essays by teachers*. 3rd ed. Auroville, India: Sri Aurobindo International Institute of Educational Research (SAIIER), 2018.
15. *Teachers' Reflections*. Auroville Wiki, 2016. https://wiki.auroville.org.in/wiki/Teachers%27_reflections.
16. Watts, Heidi. *Little by Little - The Evolution of Schooling in Auroville 1966-1980 (Part I)*. Auroville, India: Sri Aurobindo International Institute of Educational Research (SAIIER), 2005.

17. Watts, Heidi. *What Is Special About The Kindergarten In Auroville?* Auroville, India: Sri Aurobindo International Institute of educational Research (SAIIER), 2018.

Articles

1. [University Linkages, Auroville Education Platform, 2018] 'Linkages with World's Universities.' Auroville Campus: Re-imagining the Univers-city, 2018. <https://edu.auroville.org/university-linkages>.
2. 'The Multiversity Proposal.' Auroville Today, Issue No. 389, December 2021. <https://avtoday.auroville.org/articles/946>.
3. '47 Books and Counting.' *Auroville Today*, Issue No. 406, May 2023.
4. 'Photos Collection: The Mother (1953).' Sri Aurobindo and the Mother, n.d. https://sri-aurobindo.co.in/images/ma/index_09_e.htm#table_1457.
5. 'Teachers Training: Books Edited by Kireet Joshi.' Kireet Joshi Archives, n.d. <https://kireetjoshi.com/category/teachers-training/>.
6. 'Youth Day Festival 2023.' *Auroville Today*, Issue No. 410, September 2023.
7. 'YouthLink.' Auroville: the City of Dawn, February 8, 2022.
8. Aggarwal, Sanjeev. 'Innovating in a Village School: Udavi, a Case Study.' Auroville: The City of Dawn, September 30, 2020. <https://auroville.org/page/innovating-in-a-village-school-udavi-a-case-study-247>.
9. Andrade, Heidi L. 'A Critical Review of Research on Student Self-Assessment.' *Frontiers in Education* 4 (August 27, 2019).
10. Auroville Learning Network | A network for work experience and learning in Auroville, n.d. <https://auroville-learning.net/>.
11. Banerjee, Anurag. 'Thirty Photographs of the Mother Inaugurating the Sri Aurobindo International Centre of Education.' Overman Foundation, January 9, 2017. <https://overmanfoundation.wordpress.com/2017/01/09/thirty-photographs-of-the-mother-inaugurating-the-sri-aurobindo-international-centre-of-education/>.
12. Black, Paul, and Dylan Wiliam. 'Classroom Assessment and Pedagogy.' *Assessment in Education: Principles, Policy & Practice* 25, no. 6 (March 22, 2018): 551–75.
13. Boubouka, Maria, and Kyparisia A. Papanikolaou. 'Alternative Assessment Methods in Technology Enhanced Project-Based Learning.' *International Journal of Learning Technology* 8, no. 3 (October 8, 2013): 263–96.
14. Branco, Rachel C. 'A Semester without Exams: Approaches in a Small and Large Course.' *Journal of Undergraduate Neuroscience Education* 20, no. 1 (December 24, 2021): A58–72.
15. Çalışkan, Hüseyin, and Yasemin Kaşıkçı. 'The Application of Traditional and Alternative Assessment and Evaluation Tools by Teachers in Social Studies.' *Procedia - Social and Behavioral Sciences* 2, no. 2 (2010): 4152–56.
16. Deng, Chunrao, and David Robert Carless. 'Examination Preparation or Effective Teaching: Conflicting Priorities in the Implementation of a Pedagogic Innovation.' *Language Assessment Quarterly* 7, no. 4 (November 20, 2010): 285–302.
17. Elkhoury, Eliana, and Robert D. Winkler. Rep. *A Guide to Alternative Assessments*. York University, November 23, 2020.

18. Hamayan, Else V. 'Approaches to Alternative Assessment.' *Annual Review of Applied Linguistics* 15 (March 1995): 212–26.
19. James, David, and Jonathan Simmons. 'Alternative Assessment for Learner Engagement in a Climate of Performativity: Lessons from an English Case Study.' *Assessment in Education: Principles, Policy & Practice* 14, no. 3 (October 23, 2007): 353–71.
20. Kleibert, J. M., Bobée, A., Rottlieb, T., & Schulze, M. (2021). 'Transnational education zones: Towards an urban political economy of 'education cities'.' *Urban Studies* 58(14): 2845–2862.
21. Mphahlele, L. K. 'School Cluster System: A Qualitative Study on Innovative Networks for Teacher Development.' *Procedia - Social and Behavioral Sciences* 47 (2012): 340–43.
22. Tewari, Deepti. 'Unending Education, Constant Progress and a Youth That Never Ages. Sri Aurobindo's Philosophy of Education in Today's Context.' *National Seminar on Education Organized by the Indian Council of Philosophical Research*. Lecture, 2002 (on file).
23. Towles-Reeves, Elizabeth, Harold Kleinert, and Monicah Muhomba. 'Alternate Assessment: Have We Learned Anything New?' *Exceptional Children* 75, no. 2 (January 1, 2009): 233–52.
24. Turnbull, Darren, Ritesh Chugh, and Jo Luck. 'Learning Management Systems: A Review of the Research Methodology Literature in Australia and China.' *International Journal of Research & Method in Education* 44, no. 2 (March 5, 2020): 164–78.

Reports

1. [OECD, 2014] Guerriero, Sonia. Rep. *Teachers' Pedagogical Knowledge and the Teaching Profession: Background Report and Project Objectives*. OECD, 2014.
2. *Annual Report*. Auroville: Sri Aurobindo International Institute of Educational Research (SAIIER), 1984-1985. 1985-1986. 1986-1987. 1987-1988. 1988-1989. 1989-1990. 1990-1991. 1991-1992. 1992-1993. 1993-1994. 1994-1995. 1995-1996. 1996-1997. 1997-1998. 1998-1999. 1999-2000. 2000-2001. 2001-2002. 2002-2003. 2003-2004. 2004-2005. 2005-2006. 2006-2007. 2007-2008. 2008-2009. 2009-2010. 2010-2011. 2011-2012. 2012-2013. 2013-2014. 2014-2015. 2015-2016. 2016-2017. 2017-2018. 2018-2019. 2019-2020. 2020-2021. 2021-2022 (on file).
3. Helen, and Manjula. Working paper. *Exploring Auroville's Capacity to Flourish Interim Findings from Research Project*. Auroville: SAIIER, 2021 (on file).
4. Joshi, Kireet. *Brief on Sri Aurobindo International Institute of Educational Research*. Kireet Joshi Archives. Accessed 2023. <https://kireetjoshi.in/books/articles/sri-aurobindo-international-institute-of-educational-research-saiier/brief-on-sri-aurobindo-international-institute-of-educational-research>.
5. Joshi, Kireet. *Centre of International Research in Human Unity (CIRHU)*. Kireet Joshi Archives. Accessed 2023. <https://kireetjoshi.in/books/articles/centre-of-international-research-in-human-unity-cirhu-auroville>.

6. Joshi, Kireet. *Children's University*. Commissionerate of Higher Education, Government of Gujarat, 2010. <https://motherandsriaurobindo.in/disciples/kireet-joshi/books/childrens-university/>.
7. Kärkkäinen, Kiira, and Stéphan Vincent-Lancrin. Working paper. *Sparking Innovation in STEM Education with Technology and Collaboration: A Case Study of the HP Catalyst Initiative*. OECD Education, April 17, 2013.
8. Lung, Jean-Yves, and Suryamayi Clarence-Smith. Rep. *Research Agenda for Auroville 2022* (on file).
9. McNeal, Shelly. *Integral Education and Leadership: Discovering the Nation Soul*, 2014 (on file).
10. Ministry of Human Resource Development, Government of India. *Report of the Visiting Committee*. November 28, 2001 (on file).
11. OECD. Rep. *Assessment for Learning Formative Assessment: OECD/CERI International Conference 'Learning in the 21st Century: Research, Innovation and Policy'*. OECD-CERI, 2008. <https://www.oecd.org/site/educeri21st/40600533.pdf>.
12. Passage. *Auroville: Sri Aurobindo International Institute of Educational Research*, Auroville Press, 2010 (on file).
13. *Ritam: A Journal of Material and Spiritual Researches in Auroville* 8, no. 1 (November 2011). 9, no. 1 (January 2013). 7, no. 1 (February 2010). 2, no. 1 (August 2004). 2, no. 2 (February 2005). 4, no. 1 (August 2006). 7, no. 2 (November 2010). 4, no. 2 (February 2007). 5, no. 1 (May 2008). 5, no. 2 (December 2008). 6, no. 1 (June 2009) (on file).
14. *SAIIER Brochure*. Auroville, India: Sri Aurobindo International Institute of Educational Research, 2019 (on file).
15. *Supportive Learning Project (SLP)*. Auroville: Teacher's Centre, 2022 (on file).
16. Suryamayi, Henrike, and Jean-Yves. *Glimpses of Possible Research in Auroville*. Auroville, 2022 (on file).
17. Teacher's Centre. 'Supportive Learning Project (SLP) Timeline'. Presentation, Auroville, 2022 (on file).
18. Teacher's Centre. 'Supportive Learning Satellite: An Inclusive Education Approach'. Presentation, Auroville (on file).
19. Tewari, Deepti. 'Auroville Education Survey (1968-2013).' Survey Design. Auroville, India. December 19th, 2016 (on file).
20. *Workshops That Happened in Teachers' Center in 2021-2022*. Rep. Auroville: Teacher's Centre, 2021 (on file).

Correspondence and Administrative Documents

1. [SAIIERa, 2023] Rep. *SAIIER Publications*. Auroville, India: Sri Aurobindo International Institute of Educational Research, 2023 (on file).
2. [SAIIERb, 2023] Rep. *Questionnaire (Part-I) on Consideration of Demands for Grants (2023-24) of Department of Higher Education, Ministry of Education by the Department Related Parliamentary Standing Committee on Education, Women, Children, Youth and Sports: Answers from SAIIER*. Auroville, India: Sri Aurobindo International Institute of Educational Research, 2023 (on file).

3. Kailas Jhaveri. *Permanent Cultural Pavilions in Auroville (Presented at the UNESCO General Conference, Paris)*. Auroville , India: Auroville Archives, 1974.
4. Letter. 'Scheme for the Development of Auroville.' Auroville, Tamil Nadu: Auroville Archives (uncatalogued), February 7, 1987.

D. Environment and Ecology

Books

1. Glaeser, Edward L. *Triumph of the City: How Our Greatest Invention Makes Us Richer, Smarter, Greener, Healthier, and Happier*. New York, United States: Penguin Books, 2012.
2. Shrestha, Krishna, Hemant Ojha, Phil McManus, Anna Rubbo, and Krishna Kumar Dhote, eds. *Inclusive Urbanization: Rethinking Policy, Practice, and Research in the Age of mit*. 1st ed. Oxfordshire, England: Routledge, 2014.

Articles

1. 'New experiments at the Matrimandir Lake' *Auroville Today*, Issue No. 407-408, June & July 2023.
2. 'Auroville Agriculture in 2015.' Auroville Radio, April 19, 2015. <https://www.aurovilleradio.org/auroville-agriculture-in-2015/>.
3. 'Auroville Sustainable Agriculture Plan.' Auroville Radio, February 14, 2011. <https://www.aurovilleradio.org/auroville-sustainable-agriculture-plan/>.
4. Arabindoo, Pushpa. 'Renewable Energy, Sustainability Paradox and the Post-Urban Question.' *Urban Studies* 57, no. 11 (December 17, 2019): 2300–2320.
5. Belli, Laura, Antonio Cilfone, Luca Davoli, Gianluigi Ferrari, Paolo Adorni, Francesco Di Nocera, Alessandro Dall'Olio, Cristina Pellegrini, Marco Mordacci, and Enzo Bertolotti. 'IoT-Enabled Smart Sustainable Cities: Challenges and Approaches.' *Smart Cities* 3, no. 3 (September 18, 2020): 1039–71.
6. Boschken, Herman L. 'Global Cities Are Coastal Cities Too: Paradox in Sustainability?' *Urban Studies* 50, no. 9 (October 30, 2012): 1760–78.
7. Causone, Francesco, Andrea Sangalli, Lorenzo Pagliano, and Salvatore Carlucci. 'Assessing Energy Performance of Smart Cities.' *Building Services Engineering Research and Technology* 39, no. 1 (August 7, 2017): 99–116.
8. Faggian, Alessandra, Mark Partridge, and Edward J. Malecki. 'Creating an Environment for Economic Growth: Creativity, Entrepreneurship or Human Capital?' *International Journal of Urban and Regional Research* 41, no. 6 (November 20, 2017): 997–1009.
9. Güneralp, Burak, and Karen C. Seto. 'Environmental impacts of urban growth from an integrated dynamic perspective: A case study of Shenzhen, South China.' *Global Environmental Change* 18, no. 4 (2008): 720-735.
10. Kaufmann, Robert K., Karen C. Seto, Annemarie Schneider, Zouting Liu, Liming Zhou, and Weile Wang. 'Climate response to rapid urban growth: Evidence of a human-induced precipitation deficit.' *Journal of Climate* 20, no. 10 (2007): 2299-2306.
11. Kundoo, Anupama. 'Green Building Strategies for a Rapidly Urbanising India.' *Survey of the Environment*, 2012, 72–75.
12. Larson, William, and Anthony Yezer. 'The Energy Implications of City Size and Density.' *Journal of Urban Economics* 90 (November 2015): 35–49.
13. Lehmann, Steffen. 'Sustainable Urbanism: Towards a Framework for Quality and Optimal Density?' *Future Cities and Environment* 2 (August 5, 2016).

14. Quan, S.J., Economou, A., Grasl, T., et al. 'An exploration of the relationship between density and building energy performance.' *Urban Des Int* 25 (2020): 92–112.
15. Roseland, Mark. 'Dimensions of the eco-city.' *Cities* 14, no. 4 (1997): 197-202.
16. Torrey, Barbara Boyle. 'Urbanization: An Environmental Force to Be Reckoned With.' PRB, April 23, 2004. <https://www.prb.org/resources/urbanization-an-environmental-force-to-be-reckoned-with/>.
17. van den Akker, J., & Lipp, J. (2004). 'The power of human unity: Renewable energy in Auroville.' *Refocus* 5(3): 26-29.
18. Yang, Xuchao, Wenzhe Yue, Honghui Xu, Jingsheng Wu, and Yue He. 'Environmental consequences of rapid urbanization in Zhejiang province, East China.' *International journal of environmental research and public health* 11, no. 7 (2014): 7045-7059.

Reports

1. Evangelista, Jonella, Sarah Ezzio, Anna Geladi, Alex Gordon, Michael Hanifi, Peter Huan, Phillip Prell, et al. Rep. Supervised by Ajay Agarwal. *Growth Management Framework for Settlements in the Auroville Green Belt*. Auroville: SURP Queen's University, Canada, 2018 (on file).
2. Stein, David, and Achva Benzinberg Stein. Rep. *The Green Belt Development Plan and the Green Belt Land Use Plan*, 2013, 2015.
3. *Surface Water Sourcing Study for Auroville City Area: A Study Exploring a Multi-Sourcing Approach for Auroville with the Integration of Matrimandir Lake*. Rep. Auroville Centre for Scientific Research (CSR), July 2013.

Correspondence and Administrative Documents

1. 'Auroville Electrical Infrastructure: Plans and Work in Progress'. Presentation, Auroville, 2023.
2. Auroville Electrical Energy: Vision, Status and Plan'. Presentation, Auroville, 2021.

E. Economy and Commerce

Books

1. Adler, Matthew D., and Ole F. Norheim. 'Introduction.' Chapter. In *Prioritarianism in Practice*, edited by Matthew D. Adler and Ole F. Norheim, 1–36. Cambridge, England: Cambridge University Press, 2022.
2. Bairoch, Paul. *Cities and Economic Development From the Dawn of History to the Present*. Translated by Christopher Braider. Chicago, United States: University of Chicago, 1991.
3. Best, Michael H. 'The Economics of Innovation behind Cluster Dynamic Processes.' Chapter. In *The Oxford Handbook of Industrial Hubs and Economic Development*, edited by Arkebe Oqubay and Justin Yifu Lin, 64–76. Oxford, England: Oxford University Press, 2020.
4. Braunerhjelm, Pontus, and Maryann P. Feldman, eds. *Cluster Genesis: Technology-Based Industrial Development*. Oxford Academic. Oxford, England: Oxford Univ. Press, 2006.
5. Breschi, Stefano, and Franco Malerba, eds. *Clusters, Networks, and Innovation*. Oxford, England: Oxford University Press, 2006.
6. 'Future of Work.' Organisation for Economic Co-operation and Development (OECD), n.d. <https://www.oecd.org/future-of-work/>.
7. 'The Future of Work.' International Labour Organization, 2023. <https://www.ilo.org/global/topics/future-of-work/lang—en/index.htm>.
8. George, Vic. 'The Market, Laissez-Faire and Welfare: Adam Smith (1723–90).' Chapter. In *Major Thinkers in Welfare: Contemporary Issues in Historical Perspective*, 155–78. Bristol, England: Policy Press, 2010.
9. Hicks, John. *A Market Theory of Money*. Oxford, England: Clarendon Press, 1989.
10. Hurley, Susan. 'Choice and Incentive Inequality.' Chapter. In *The Egalitarian Conscience: Essays in Honour of G. A. Cohen*, edited by Christine Sypnowich, 130–53. Oxford, England: Oxford University Press, 2006.
11. Kelly, Duncan. 'Adam Smith and The Limits of Sympathy.' Essay. In *The Oxford Handbook of Adam Smith*, edited by Christopher J. Berry, Craig Smith, and Maria Pia Paganelli, 201–18. Oxford, England: Oxford University Press, 2013.
12. Kincaid, Harold, and Ross, Don, eds. *The Oxford Handbook of Philosophy of Economics*. Oxford, England: Oxford University Press, 2009.
13. Kitamura, Yukinobu. 'Overview of the History of Money.' Chapter. In *Quest for Good Money: Past, Present and Future*, 1–15. Hitotsubashi University IER Economic Research Series. Springer, 2022.
14. Mehta, Pratap Bhanu. 'Self-Interest and Other Interests.' Chapter. In *The Cambridge Companion to Adam Smith*, edited by Knud Haakonssen, 246–69. Cambridge, England: Cambridge University Press, 2006.
15. Miller, David. *Market, State, and Community: Theoretical Foundations of Market Socialism*. Oxford, England: Clarendon Press, 1991.
16. Olsaretti, Serena, ed. *The Oxford Handbook of Distributive Justice*. Oxford Academic. Oxford, England: Oxford University Press, 2018.

17. Oqubay, Arkebe, and Justin Yifu Lin, eds. *The Oxford Handbook of Industrial Hubs and Economic Development*. Oxford Academic. Oxford, England: Oxford University Press, 2020.
18. Postigo, Gloria Zúñigay. 'Adam Smith on Sympathy: From Self-Interest to Empathy.' Chapter. In *Propriety and Prosperity New Studies on the Philosophy of Adam Smith*, edited by David F. Hardwick and Leslie Marsh, 136–46. Archival Insights into the Evolution of Economics. London, England: Palgrave Macmillan, 2014.
19. Sandel, Michael J. *What Money Can't Buy: The Moral Limits of Markets*. New York, United States: Farrar, Straus and Giroux, 2013.
20. Satz, Debra. 'The Market's Place and Scope in Contemporary Egalitarian Political Theory.' Chapter. In *Why Some Things Should Not Be for Sale: The Moral Limits of Markets*, 63–90. Oxford, England: Oxford University Press, 2010.
21. Satz, Debra. *Why Some Things Should Not Be for Sale: The Moral Limits of Markets*. Oxford Academic. Oxford, England: Oxford University Press, 2010.
22. Skidelsky, Robert. 'The Future of Work.' Chapter. In *Work in the Future: The Automation Revolution*, edited by Robert Skidelsky and Nan Craig, 9–21. London, England: Palgrave Macmillan, 2020.
23. Skidelsky, Robert, and Edward Skidelsky. *How Much is Enough? Money and the Good Life*. London, United Kingdom: Penguin Books, 2013.
24. Skidelsky, Robert, and Nan Craig, eds. *Work in the future: The automation revolution*. Cham, Switzerland: Palgrave Macmillan, 2020.
25. Thomas, Henk, and Manuel Thomas. *Economics for People and Earth: The Auroville Case 1968-2008*. 1st ed. Auroville, India: Social Research Centre, 2013.
26. Yang, Xiaokai, and Siang Ng. 'Specialization and Division of Labour: A Survey.' Chapter. In *Increasing Returns and Economic Analysis*, edited by Kenneth J. Arrow, Yew-Kwang Ng, and Xiaokai Yang, 3–63. London, England: Palgrave Macmillan, 1998.

Articles

1. [BCC, 2022-23] 'FY 22-23 Budget.' Auroville Budget Coordination Committee, n.d. <https://budget.auroville.org.in/budget-fy22-23>.
2. 'Division of Labour- an Overview.' ScienceDirect Topics. Accessed 2023. <https://www.sciencedirect.com/topics/economics-econometrics-and-finance/division-of-labour>.
3. 'Exploring Prosperity.' Auroville- the City of Dawn, March 26, 2018. <https://auroville.org/page/exploring-prosperity>.
4. 'New Horizon Sugar Mills, Foundation Stone Ceremony 12 April, 1959.' Sri Aurobindo and the Mother. https://sri-aurobindo.co.in/images/00003/01370_m_e.htm.
5. 'Revisioning Auroville's Economy.' *Auroville Today*, Issue No. 328, November 2016.
6. 'The Auroville Economy: In Dire Straits.' *Auroville Today*, Issue No. 321, April 2016.
7. Abutabenjeh, S., Nukpezah, J. A., & Azhar, A. (2022). 'Do Smart Cities Technologies Contribute to Local Economic Development?' *Economic Development Quarterly* 36(1): 3–16.

8. Accountancy Today Is Highly Complex.’ Auroville Today, Issue No. 407-408, June-July, 2023.
9. Albertsen, Andreas. ‘Markets, Distributive Justice and Community: The Egalitarian Ethos of G. A. Cohen.’ *Political Research Quarterly* 72, no. 2 (2018): 376–98.
10. Bal, Debi Prasad, Devi Prasad Dash, and Bibhudutta Subhasish. ‘The Effects of Capital Formation on Economic Growth in India: Evidence from ARDL-Bound Testing Approach.’ *Global Business Review* 17, no. 6 (October 25, 2016): 1388–1400.
11. Banerjee, Anurag. ‘Three Hundred and Thirty Photographs of the Mother with Udar Pinto.’ Overman Foundation, July 30, 2021. <http://overmanfoundation.org/three-hundred-and-thirty-photographs-of-the-mother-with-udar-pinto/>.
12. Bauman, David. ‘Integrity and Justice: What Is Required of Free Market Participants?’ *Palgrave Communications* 3, no. 17046 (June 27, 2017).
13. Chang, Yongsung, and Sun-Bin Kim. ‘The Price of Egalitarianism.’ *The B.E. Journal of Macroeconomics* 11, no. 1 (January 3, 2012).
14. Chen, Mingxing, Hua Zhang, Weidong Liu, and Wenzhong Zhang. ‘The global pattern of urbanization and economic growth: evidence from the last three decades’. *PloS one* 9, no. 8 (2014): e103799.
15. Dick, David G. ‘What Money Is and Ought To Be.’ *Journal of Social Ontology* 6, no. 2 (March 30, 2021): 293–313.
16. Giuliano, Genevieve, Sanggyun Kang, and Quan Yuan. ‘Agglomeration Economies and Evolving Urban Form.’ *The Annals of Regional Science* 63 (November 25, 2019): 377–98.
17. Guala, Francesco. ‘Money as an Institution and Money as an Object.’ *Journal of Social Ontology* 6, no. 2 (February 8, 2021): 265–79.
18. Herlitz, Anders. ‘The Indispensability of Sufficiency.’ *Critical Review of International Social and Political Philosophy* 22, no. 7 (June 5, 2018): 929–42.
19. Kjaer, Poul F., and Antje Vetterlein. ‘Regulatory Governance: Rules, Resistance and Responsibility.’ *Contemporary Politics* 24, no. 5 (March 26, 2018): 497–506.
20. Koelemaij, J., Taveirne, S., & Derudder, B. (2023). ‘An economic geography perspective on city diplomacy.’ *Urban Studies* 60(6): 995–1012.
21. Lee, Jongkwan. ‘The Role of a University in Cluster Formation: Evidence from a National Institute of Science and Technology in Korea.’ *Regional Science and Urban Economics* 86 (January 2021).
22. Messaoud, Boudhiaf, and Zribi El Ghak Teheni. ‘Business Regulations and Economic Growth: What Can Be Explained?’ *International Strategic Management Review* 2, no. 2 (December 2014): 69–78.
23. Moulin, Herve. ‘The Pure Compensation Problem: Egalitarianism Versus Laissez-Fairism.’ *The Quarterly Journal of Economics* 102, no. 4 (November 1, 1987): 769–83.
24. Néron, Pierre-Yves. ‘Rethinking the Very Idea of Egalitarian Markets and Corporations: Why Relationships Might Matter More than Distribution.’ *Business Ethics Quarterly* 25, no. 1 (April 27, 2015): 93–124.
25. Ostroy, Joseph M., and Ross M. Starr. ‘Chapter 1 the Transactions Role of Money.’ *Handbook of Monetary Economics* 1 (1990): 3–62.

26. Peck, Jamie. 'Economic Rationality Meets Celebrity Urbanology: Exploring Edward Glaeser's City.' *International Journal of Urban and Regional Research* 40, no. 1 (May 18, 2016): 1–30.
27. Sampathkumar, Harini. *Auroville: Areas of Strategic Planning for the Workforce*. USS Final Paper, 2006 (on file).
28. Ucak, Ayhan. 'Adam Smith: The Inspirer of Modern Growth Theories.' *Procedia - Social and Behavioral Sciences* 195 (July 3, 2015): 663–72.

Reports

1. Albaz, Abdulaziz, Marco Dondi, Tarek Rida, and Jörg Schubert. Rep. *Unlocking Growth in Small and Medium-Size Enterprises*. McKinsey & Company, June 2020.
2. *Annual Report 2022-23*. Rep. Ministry of micro, small and medium enterprises (Government of India), 2022.
3. *City Services Yearly Financial Report: 1st April 2015 to 31st March 2016*. Rep. Auroville, India: Budget Coordination Committee, 2016 (on file).
4. *City Services Yearly Financial Report: 1st April 2016 to 31st March 2017*. Rep. Auroville, India: Budget Coordination Committee, 2017 (on file).
5. *City Services Yearly Financial Report: April 2018 to March 2019*. Rep. Auroville, India: Budget Coordination Committee, 2019 (on file).
6. *City Services Yearly Financial Report: April 2019 to March 2020*. Rep. Auroville, India: Budget Coordination Committee, 2020 (on file).
7. Duranton, Gilles, and William R. Kerr. Working paper. *The Logic of Agglomeration*. Harvard Business School, July 2015.
8. Fanning, *For All/Pour Tous and the Early Years of Its Economic Development*, 2011 (on file).
9. *Research and Innovation Clusters: Policy Briefing*. Rep. The Royal Society, July 2020.

Correspondence, Administrative and Legal Documents

1. [Parasaran, 2014a] Parasaran, Mohan. Letter to Auroville Foundation. 'Legal Opinion.' Supreme Court of India, New Delhi: India, March 21, 2014.
2. [Parasaran, 2014b] Parasaran, Mohan. Letter to Auroville Foundation. 'Legal Opinion.' Supreme Court of India, New Delhi: India, May 9, 2014.
3. Assistant Commissioner of Income Tax (Exemptions) v. Ahmedabad Urban Development Authority (Civil Appeal No. 21762 of 2017) (Supreme Court of India October 19, 2022).
4. Environment, Climate Change and Forests Department, Government of Tamil Nadu, Tamil Nadu Green Climate Company. G.O. (Ms.) No. 101, Tamil Nadu: 2021.
5. Industries, Investment Promotion and Commerce Department, Government of Tamil Nadu, Implementation of the Tamil Nadu Logistics Policy and Integrated Logistics Plan 2023. G.O. (Ms). No. 73, Tamil Nadu: 2023.
6. Industries, Investment Promotion and Commerce Department, Government of Tamil Nadu, Implementation of Tamil Nadu Electric Vehicles Policy 2023. G.O. (Ms). No. 41, Tamil Nadu: 2023.

7. Industries, Investment Promotion and Commerce Department, Government of Tamil Nadu, Implementation of the Tamil Nadu Life Sciences Promotion Policy 2022. G.O. (Ms). No. 154, Tamil Nadu: 2022.
8. Palkhivala, Behram. Letter to Mr. Michael Tait. Bombay, Maharashtra: India, September 9, 1993.
9. Rangarajan Narasimhan v. State of Tamil Nadu and Ors. (WP 16079 / 2021) (High Court of Madras August 11, 2022).
10. Sabir Ali Khan v. Syed Mohd. and Ors. (Civil Appeal No. 7086-7086 / 2009) (Supreme Court of India April 13, 2023).

F. Outreach

Articles

1. [JPAL, 2022a] ‘Institutionalizing a Culture of Evidence-Informed Policymaking in Tamil Nadu (J-PAL Evidence to Policy Case Study).’ Abdul Latif Jameel Poverty Action Lab (J-PAL), January 2022. <https://www.povertyactionlab.org/case-study/institutionalizing-culture-evidence-informed-policymaking-tamil-nadu>.
2. [JPAL, 2022b] ‘Teaching at the Right Level to Improve Learning (J-PAL Evidence to Policy Case Study).’ Abdul Latif Jameel Poverty Action Lab (J-PAL), August 2022. <https://www.povertyactionlab.org/case-study/teaching-right-level-improve-learning>.
3. [JPAL, 2023a], Breza, Emily, Dean Karlan, and Michael Hou. Rep. *Microcredit: Impacts and Promising Innovations*. Abdul Latif Jameel Poverty Action Lab (J-PAL), May 2023.
4. [JPAN, 2023b] ‘Improving agricultural information and extension services to increase small-scale farmer productivity.’ Abdul Latif Jameel Poverty Action Lab (J-PAL), September 2023. <https://www.povertyactionlab.org/policy-insight/improving-agricultural-information-and-extension-services-increase-small-scale>.
5. [Tacoli a, 1998] Tacoli, Cecilia. ‘Beyond the rural-urban divide.’ *Environment and urbanization* 10, no. 1 (1998): 3-4.
6. [Tacoli b, 1998] Tacoli, Cecilia. ‘Rural-urban interactions: a guide to the literature.’ *Environment and urbanization* 10, no. 1 (1998): 147-166.
7. ‘10 Years of Auroville Tango Festivals’ *Auroville Today*, Issue No. 406, May 2023.
8. ‘Impact of School Leadership Training on Management Practices and Student Learning in India.’ Abdul Latif Jameel Poverty Action Lab (J-PAL), n.d. <https://www.povertyactionlab.org/evaluation/impact-school-leadership-training-management-practices-and-student-learning-india>.
9. ‘Leadership Development in Public Education Systems.’ Creatnet Education, n.d. <https://creatnet.org/leadership-development-in-public-education-systems/>.
10. ‘Rural-Urban Linkages: Synergies, Threats and Limitations.’ *Rural 21: The International Journal for Rural Development* 52: 1-44, 2018.
11. ‘STEAM Fest 2023 @ Deepanam’ *Auroville Today*, Issue No. 406, May 2023.
12. ‘The Auroville Youth Integration Programme.’ *Auroville Today*, Issue No. 407-408, June & July 2023.
13. ‘The Entry Board: An Interview with the Interviewers.’ *Auroville Today*, Issue No. 407-408, June-July 2023.
14. ‘Towards Auroville: A journey of dedication and resilience’ *Auroville Today*, Issue No. 407-408, June & July 2023.
15. ‘YouthLink, my University of Life’ *Auroville Today*, Issue No. 407-408, June & July 2023.
16. “Auroville News & Notes (No. 872).” *Auroville Wiki*, May 29, 2021.
17. *Auroville Today*, January 2017, No. 330, p. 19. November 2005, No. 202, p. 6. March 2007, No. 217, p. 2. January 2016, No. 318, p. 17. August 2017, No. 337. December 2020, No. 377, p. 10.

18. Banerjee, Abhijeet, Esther Duflo, Nathanael Goldberg, Dean Karlan, Robert Osei, William Pariente, Jeremy Shapiro, Bram Thuysbaert, and Christopher Udry. 'A Multifaceted Program Causes Lasting Progress for the Very Poor: Evidence from Six Countries.' *Science* 348, no. 6236 (May 15, 2015).
19. Bharti, Nisha. 'Livelihood Enhancement through Community-owned Agro Service Centres: A Case Study of MAVIM.' *International Journal of Rural Management* 16(1) (2020): 33-61.
20. Choithani, Chetan, Robbin Jan van Duijne, and Jan Nijman. 'Changing livelihoods at India's rural-urban transition.' *World Development* 146 (2021): 1056-17.
21. Dutta, Subrata, and Subhendu Chakrabarti. 'Rural-Urban Linkages, Labor Migration & Rural Industrialization in West Bengal.' *Indian Journal of Industrial Relations* 50, no. 3 (2015): 397-411.
22. *Dynamic Rural-Urban Linkages for Decent Rural Employment*. Rep. Food and Agriculture Organization of the United Nations, 2017. <https://www.fao.org/3/i6595e/i6595e.pdf>.
23. Funnell, D. C. 'Urban-Rural Linkages: Research Themes and Directions.' *Geografiska Annaler. Series B, Human Geography* 70, no. 2 (1988): 267-74.
24. Gebre, Tewelde, and Berhanu Gebremedhin. 'The mutual benefits of promoting rural-urban interdependence through linked ecosystem services.' *Global ecology and conservation* 20 (2019): e00707.
25. McIntosh, Craig, Tavneet Suri, and Emily Sylvia. Rep. *Incentivizing Higher-Quality Agricultural Outputs*. Abdul Latif Jameel Poverty Action Lab (J-PAL), September 2021.
26. Steinberg, Florian. Working paper. *Rural-Urban Linkages: An Urban Perspective*. Rimisp, Santiago, Chile, October 2014. https://www.rimisp.org/wp-content/files_mf/1422298948R_ULinkages_Urbanperspective_Final_edited.pdf.
27. Tacoli, Cecilia, Gordon McGranahan, and David Satterthwaite. 'Urbanisation, Rural-Urban Migration and Urban Poverty.' International Institute for Environment and Development, 2015.
28. Tacoli, Cecilia. 'Editorial: Governance, migration and local development.' *Environment and Urbanization* 22, no. 1 (2010): 5-11.
29. Tacoli, Cecilia. 'The links between urban and rural development.' *Environment and urbanization* 15, no. 1 (2003): 3-12.
30. *Villupuram District Agricultural Plan*. Rep. National Agriculture Development Project, 2008. https://agritech.tnau.ac.in/govt_schemes_services/pdf/govt_schemes_nadp_dap_Villupuram.pdf.
31. *Villupuram District Human Development Report*. Rep. State Planning Commission Tamil Nadu, 2017. https://spc.tn.gov.in/DHDR/Vlupuram_dt.pdf.

Reports

1. *Annual Report and Accounts*. Auroville: Auroville Foundation, 2004-2005. 2005-2006. 2006-2007. 2007-2008. 2008-2009. 2010-11. 2011-12. 2012-13. 2013-14. 2014-15. 2015-16. 2016-17. 2017-18. 2018-19 (on file).

2. Armstrong, Natalie, Sarah Butt, Alanna Damp, Nadia El Dabee, Carling Fraser, Kassidee Fior, Kelsey Jones, and Vanessa Smith. Rep. Supervised by Ajay Agarwal and Lalit Kishor Bhati. *Tourism Impact Management Framework For Auroville, India*. SURP Queen's University, Canada, 2019 (on file).
3. *Auroville Bio-Regional Development Activities: Learning from Each Other to Deliver the Promise of Auroville*. Rep. Auroville Foundation, November 8, 2020. <https://auroville.org/page/auroville-bio-regional-development-activities-987>.
4. Department of Tourism and Culture Government of Tamil Nadu. Rep. *Initial Environmental Examination- IND: Infrastructure Development Investment Program for Tourism (IDIPT) Tranche 4*. Asian Development Bank, February 2018. https://www.adb.org/sites/default/files/project-documents/40648/40648-037-iec-en_5.pdf.
5. Netter, William T. 'The Television for the New Age.' September 1969. Reports from the Department of Art, Auroville (on file).
6. Planning, Development and Special Initiatives Department, Government of Tamil Nadu, Tamil Nadu Innovation Initiatives-State Innovation Fund-Guidelines for and Implementation of Innovative Schemes-Modified Orders. G.O (MS) No. 69, Tamil Nadu: 2023. https://spc.tn.gov.in/pdfs/GO_69_TANII_Revised.pdf.

Correspondence and Administrative Documents

1. Auroville Town Development Council and Bommayapalayam Panchayat. Memorandum of Understanding. March 26, 2014 (on file).

G. Miscellaneous

Books

1. Adorno, Theodor W., and Max Horkheimer. *Dialectic of Enlightenment*. Edited by Gunzelin Schmid Noerr. Translated by Edmund Jephcott. 1st ed. California, United States: Stanford University Press, 2002.
2. Chattopadhyaya, D. P. 'General Introduction.' Chapter. In *History of Science, Philosophy and Culture in Indian Civilization: Synthesis of Yoga (Part 4)* 16, edited by Kireet Joshi, 1st ed. Vol. 16. New Delhi, India: Centre for Studies in Civilizations, 2011.
3. Doctor-Pingel, Mona. *Auroville Architects Monograph Series: Poppo Pingel*. Ahmedabad, India: Mapin Publishers, 2012.
4. Feinberg, Joel. *Moral Limits of the Criminal Law*. 4 vols. Oxford: Oxford University Press, 1987-1990.
5. Goethe, Johann Wolfgang Von. *Maxims and Reflections*. Edited by Peter Hutchinson. Translated by Elisabeth Stopp. London, England: Penguin Classics, 1998.
6. Gupta, Pankaj Vir, Christine Mueller, and Cyrus Samii. *Golconde: The Introduction of Modernism in India*. 1st ed. New Delhi, India: Urban Crayon Press, 2010.
7. Joshi, Kireet, and D. P. Chattopadhyaya, eds. 'Satprem and Evolution II.' Chapter. In *History of Science, Philosophy and Culture in Indian Civilization: Synthesis of Yoga (Part 4)* XVI, Vol. XVI. New Delhi, India: Centre for Study in Civilizations, 2011.
8. Kapur, Akash. *Auroville: Dream & Reality: An anthology*. Haryana, India: Penguin Random House India Pvt. Ltd, 2018.
9. Kundoo, Anupama. 'Auroville: An Architectural Laboratory.' *Architectural Design* 77, no. 6.
10. Kundoo, Anupama. 'Freedom from the Known: Imagining the Future Without the Baggage of the Past.' *Architectural Design* 88, no. 3.
11. Kundoo, Anupama. *Roger Anger: Research on Beauty Architecture 1953-2008*. Berlin, Germany: Jovis Verlag, 2009.
12. MacIntyre, Alasdair. *After Virtue: A Study in Moral Theory*. 2nd ed. Indiana, United States: University of Notre Dame Press, 1984.
13. Mandeem, John. *Auroville architecture: Towards new forms for a new consciousness*. 5th ed. Auroville, Tamil Nadu: Prisma, 2014.
14. [Medhananda, 2022c] Medhananda, Swami. *Swami Vivekananda's Vedāntic Cosmopolitanism*. India: Oxford University Press, 2022.
15. Mother. *Letters to my little smile*. Pondicherry: Sri Aurobindo Ashram, Publication Dept., 1977.
16. Mother. *Paintings and Drawings*. Pondicherry: Sri Aurobindo Ashram, 1992.
17. Nirodbaran. *Twelve years with Sri Aurobindo*. Pondicherry, India: Sri Aurobindo Ashram, 1988.
18. Purani, A. B. *Evening talks with Sri Aurobindo*. Pondicherry, India: Sri Aurobindo Ashram, 1959.
19. Rangaswamy, Nanjangud Sreekantaiah. *Life and Organicism (Part 6)*. Edited by D. P. Chattopadhyaya. Vol. XII of *History of Science, Philosophy and Culture in Indian Civilization*. New Delhi, India: Munshiram Manoharlal Publishers Pvt Ltd, 2009.

20. Schiller, Friedrich. *On the Aesthetic Education of Man in a Series of letters*. Edited by E. M. Wilkinson and L. A. Willoughby. Oxford, United Kingdom: Oxford University: Clarendon Press, 1983.
21. Sethna, K. D. *The Vision and Work of Sri Aurobindo*. 2nd ed. Pondicherry, India: Sri Aurobindo Ashram Publication Department, 1992.
22. Sethna, K. D., and Bede Griffiths. *A Follower of Christ and a Disciple of Sri Aurobindo: Correspondence between Bede Griffiths & Amal Kiran*. Pondicherry, India: Sri Aurobindo Ashram Press, 2004. <https://motherandsriaurobindo.in/disciples/amal-kiran/books/a-follower-of-christ-and-a-disciple-of-sri-aurobindo/>.
23. Taylor, Charles. *Philosophical Papers*. Vol. 2. Cambridge: Cambridge University Press, 1985.
24. Taylor, Charles. *Sources of Self: The Making of the Modern Identity*. Cambridge, Massachusetts: Harvard University Press, 1989.
25. Burke, Edmund. *Reflections On The Revolution In France*. London, England: Penguin Books, 1982.
26. Chikermane, Gautam, and Devdip Ganguli. *Reading Sri Aurobindo*. Delhi, India: Penguin Random House, 2022.
27. Fassbender, Franz. *A Dream – Aims and Ideals of Auroville . Prisma Haus*. 1st ed. Auroville, India: Prisma, 2021.
28. *History of Auroville . 9 vols*. Auroville, India: Auroville Archives, n.d.
29. Jhunjhunwala, Shyam Sunder. *Down Memory Lane. Mother and Sri Aurobindo*. Pondicherry, India: Sri Aurobindo Ashram, 1996.
30. Joshi, Kireet. *Ideals of Auroville: Extracts from Conversations and Statements about Auroville in Mother's Agenda*. Auroville, India: Auroville Press Publishers, n.d.
31. Koskenniemi, Martti. *From Apology to Utopia: The Structure of International Legal Argument. Cambridge Core*. Cambridge, England: Cambridge University Press, 2009.
32. Lohman, Ruud. *A House for the Third Millennium: Essays on Matrimandir*. Auroville, India: Alain Grandcolas, 1986.
33. Lohman, Ruud. *All things new the city where everything is different*. Bilthoven, Netherlands: Ambo Publishers, 1972.
34. Majumdar, Anuradha. *Auroville: A City for the Future*. 1st ed. New Delhi, India: HarperCollins, 2017.
35. *Mother on Auroville - References in Mother's Agenda*. Auroville, India: Auroville Press, n.d.
36. Mukundananda, Swami. *Bhagavad Gita: The Song of God*. 1st ed. Bangalore, India: Rupa Publications, 2022.
37. Savitra. *Auroville, Sun Word Rising - A Trust for the Earth*. Auroville, India: The Community of Auroville, 1980.
38. Vivekananda, Swami. *The Complete Works of Swami Vivekananda*. Vol. 5. Calcutta, India: Advaita Ashrama, 2007.

Articles

1. [Medhananda, 2022a] Medhananda, Swami. 'The Playful Self-Involution of Divine Consciousness: Sri Aurobindo's Evolutionary Cosmopsychism and His Response to the Individuation Problem.' *The Monist* 105, no. 1 (January 18, 2022): 92–109.
2. [Medhananda, 2022b] Medhananda, Swami. "'A Great Adventure of the Soul': Sri Aurobindo's Vedāntic Theodicy of Spiritual Evolution.' *International Journal of Hindu Studies* 25, no. 3 (January 21, 2022): 229–57.
3. '47 books and counting' *Auroville Today*, Issue No. 406, May 2023.
4. 'Amid Protests, Authorities Push Ahead Begin Felling Trees for Crown Road in Auroville.' *The Hindu*, March 10, 2023.
5. 'Auro-Sangamam.' *Auroville: The City of Dawn*, April 11, 2019. <https://auroville.org/page/auro-sangamam>.
6. 'Auroville News & Notes.' *Auroville Wiki*, October 3, 2015. https://wiki.auroville.org.in/w/images/7/71/2015.10.03_News_%26_Notes_No._0617.pdf.
7. 'News in Brief.' *Auroville Today*, Issue No. 406, May 2023.
8. 'Notes on Sanatana Dharma.' *Auroville Today*, Issue No. 406, May 2023.
9. 'Roger Anger: 100 Years.' *AWARE Auroville*, 2023. <https://awareauroville.com/awake/roger-anger-100/>.
10. 'Sri Aurobindo World Centre for Human Unity (SAWCHU).' *Auroville: The City of Dawn*, June 22, 2019. <https://auroville.org/page/sri-aurobindo-world-centre-for-human-unity-sawchu>.
11. 'The safety and boundary awareness programme' *Auroville Today*, Issue No. 406, May 2023.
12. 'Vaastu Shastra, yantra and Auroville' *Auroville Today*, Issue No. 406, May 2023.
13. 'Working Groups.' *AWARE Auroville*, n.d. <https://awareauroville.com/affairs/organisation/working-groups/>.
14. 'Auroville City Conversations: Galaxy Plan.' *Auroville Wiki*, September 2, 2020. https://wiki.auroville.org.in/wiki/Galaxy_Plan. Accessed: July 14, 2023.
15. 'Auroville News and Notes (Number 613).' *Auroville Wiki*, September 5, 2015. (Number 614), September 12, 2015. (Number 615), September 19, 2015. (Number 616), September 26, 2015.
16. 'Georges Van Vrekhem.' *Auro E-Books*. Accessed 2023. <https://auro-ebooks.com/authors/georges-van-vrekhem/>.
17. 'Rod Hemsell.' *Auro E-Books*. Accessed 2023. <https://auro-ebooks.com/authors/rod-hemsell/>.
18. 'Sriram Panchu: It's time for Auroville to take stock.' *Auroville Today*, Issue No. 366, January 2020.
19. =1. 'Meet the Architect: Interview with Roger Anger.' *Auroville Wiki*, 2020. https://wiki.auroville.org.in/wiki/%3D1_%22Meet_the_architect%22.
20. *Auroville Today*, Issue No. 29, June 1991; Issue No. 406, May 2023.
21. *Auroville Tomorrow* Issue No. 2, February 28, 2022; Issue No. 4, July 13, 2022.

22. Bana, Sarosh. 'Auroville and the Crown Road Project: Conflict in Paradise.' *National Herald*, January 18, 2022.
23. Calhoun, Craig. 'Morality, Identity, and Historical Explanation: Charles Taylor on the Sources of the Self.' *Sociological Theory* 9, no. 2 (1991): 232–63.
24. *Collaboration: Journal of the Integral Yoga of Sri Aurobindo and the Mother* 6, no. 3 (1980): 1–24 (on file).
25. Dominique, Bosco. 'Crown Divides the People of Auroville.' *The Times of India*, December 14, 2021. <https://timesofindia.indiatimes.com/blogs/tracking-indian-communities/crown-divides-the-people-of-aurovill/>.
26. Ghisi. 'Auroville Is 40 Years Old ... and the Future.' *Ritam* 7, no. 2, 2010 (on file).
27. Jazeel, Tariq. 'Matrimandir, Auroville.' *Society and Space*, August 19, 2015. <https://www.societyandspace.org/articles/matrimandir-auroville>.
28. Joshi, Kireet. 'On Auroville.' *Kireet Joshi Archives*. Lecture. Accessed 2023. <https://www.kireetjoshiarchives.com/miscellaneous/on-auroville.html>.
29. Joshi, Kireet. *On Auroville - 12 Gardens of Matrimandir*, n.d. <https://www.kireetjoshiarchives.com/miscellaneous/on-auroville/12-gardens-of-matrimandir/&page=1>.
30. Kundoo, Anupama. 'Auroville: An Architectural Laboratory.' *Architectural Design* 77, no. 6 (2007): 50–55.
31. Kundoo, Anupama. 'Kolam: Design for the Divine.' *Auroville Today*, March 1996.
32. Kundoo, Anupama. 'Shri Aurobindo World Centre for Human Unity, Auroville.' *Journal of the Indian Institute of Architects*, October 2000.
33. Kundoo, Anupama. 'The Auroville Experiment: Building with Compressed Earth Block.' *Indian Architect & Builder, Jasubhai Publications*, December 1991.
34. Kundoo, Anupama. 'You Cannot Remain Charmed.' *Auroville Today*, December 1991.
35. Louis, Maria, ed. 'Mona Doctor-Pingel: Studio Naqshbandi.' *Architect and Interiors India* 10, no. 2, July 2018.
36. Petersen, Hannah Ellis. 'Bulldozers, Violence and Politics Crack an Indian Dream of Utopia.' *The Guardian*, January 16, 2022. <https://www.theguardian.com/world/2022/jan/16/bulldozers-violence-and-politics-crack-an-indian-dream-of-utopia>.
37. Pougault, Jean. 'Are the French in Danger in Auroville?' *AWARE Auroville*, May 26, 2023. <https://awareauroville.com/are-the-french-in-danger-in-auroville/>.
38. Rathore, Rupal. 'The Road to Utopia Is Not Smooth.' *Disegno*, January 9, 2023. <https://disegnojournal.com/newsfeed/road-to-utopia-auroville-india-crown-road-controversy>.
39. Srivathsan, A. 'Revisit: Wall House in Auroville, India by Anupama Kundoo.' *The Architectural Review*, January 18, 2023.
40. Varma, Dinesh. 'Road to the Future Spawns Discord within Auroville.' *The Hindu*, November 23, 2022. <https://www.thehindu.com/news/cities/puducherry/road-to-the-future-spawns-discord-within-auroville/article66169695.ece>.
41. Radhakrishnan, S. 'The Ethics of the Vedanta.' *International Journal of Ethics* 24, no. 2 (1913): 168–83.

42. Satprem. 'The Great Sense.' Sri Aurobindo & The Mother, June 27, 1969. https://sri-aurobindo.co.in/workings/satprem/the_grat_sense_e.htm.
43. Sen, Amartya. *Rationality and Freedom*. Cambridge (MA), United States: Harvard University Press, 2004.
44. *Turning Points - An inner story of the beginnings of Auroville*. Auroville, India: Auroville Press, 2008.

Reports

1. Architecture and Urban Design, Box No. 1, Planning Early Years. Auroville Archives, Auroville, India.

Correspondence and Administrative Documents

1. Danino, Michel. Letter to Dr Jayanti Ravi, Secretary Auroville Foundation. Gandhinagar, Gujarat: Gandhinagar, December 5, 2021 (on file).
2. Letter to Krishna and Fedrick. *Proposing candidature – Sidney Firstman / Suresh Auroville electronics IAC*. Auroville: Auroville Archives, 15 September 1988.
3. Letter. *SAS Refusing Ford Foundation offer to fund and weary of Hindocha family taking control of Auroville*. Auroville: Auroville Archives, 29 March 1969.

Audio/Visual Material

1. *Auroville: The Way Forward. Marc Luyckx and Doudou Diène Share Their Vision with Dr. Jayanti Ravi*. Auroville Foundation, YouTube, 2022. <https://www.youtube.com/watch?v=B6yNGOM4DzA>.



I saw them cross the twilight of an age,
The sun-eyed children of a marvellous dawn,
The great creators with wide brows of calm.
The massive barrier-breakers of the world
And wrestlers with destiny in her lists of will,
The labourers in the quarries of the gods.
The messengers of the Incommunicable,
The architects of immortality.
Into the fallen human sphere they came.

Sri Aurobindo, *Savitri*